

OMRON

Smart Sensors

with Ultra-High-Speed CCD Cameras

ZFV Series (Ver 2.0)

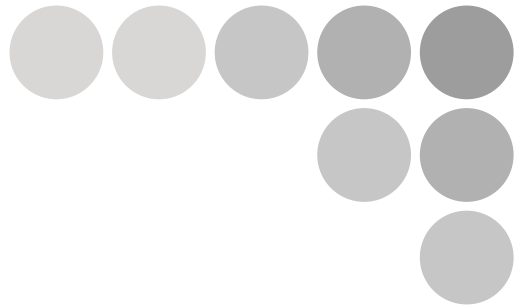

User's Manual



Cat. No. Z207-E1-03

INTRODUCTION	APPLICATION CONSIDERATIONS (Please read first)
SECTION 1	FEATURES
SECTION 2	INSTALLATION & CONNECTION
SECTION 3	SETUP
SECTION 4	APPENDIX

Introduction
Section 1
Section 2
Section 3
Section 4

User's Manual

Smart Sensors
with Ultra-high-Speed CCD Camera
ZFV Series

READ AND UNDERSTAND THIS DOCUMENT

Please read and understand this document before using the products. Please consult your OMRON representative if you have any questions or comments.

WARRANTY

OMRON's exclusive warranty is that the products are free from defects in materials and workmanship for a period of one year (or other period if specified) from date of sale by OMRON.

OMRON MAKES NO WARRANTY OR REPRESENTATION, EXPRESS OR IMPLIED, REGARDING NON-INFRINGEMENT, MERCHANTABILITY, OR FITNESS FOR PARTICULAR PURPOSE OF THE PRODUCTS. ANY BUYER OR USER ACKNOWLEDGES THAT THE BUYER OR USER ALONE HAS DETERMINED THAT THE PRODUCTS WILL SUITABLY MEET THE REQUIREMENTS OF THEIR INTENDED USE. OMRON DISCLAIMS ALL OTHER WARRANTIES, EXPRESS OR IMPLIED.

LIMITATIONS OF LIABILITY

OMRON SHALL NOT BE RESPONSIBLE FOR SPECIAL, INDIRECT, OR CONSEQUENTIAL DAMAGES, LOSS OF PROFITS OR COMMERCIAL LOSS IN ANY WAY CONNECTED WITH THE PRODUCTS, WHETHER SUCH CLAIM IS BASED ON CONTRACT, WARRANTY, NEGLIGENCE, OR STRICT LIABILITY.

In no event shall responsibility of OMRON for any act exceed the individual price of the product on which liability is asserted.

IN NO EVENT SHALL OMRON BE RESPONSIBLE FOR WARRANTY, REPAIR, OR OTHER CLAIMS REGARDING THE PRODUCTS UNLESS OMRON'S ANALYSIS CONFIRMS THAT THE PRODUCTS WERE PROPERLY HANDLED, STORED, INSTALLED, AND MAINTAINED AND NOT SUBJECT TO CONTAMINATION, ABUSE, MISUSE, OR INAPPROPRIATE MODIFICATION OR REPAIR.

SUITABILITY FOR USE

THE PRODUCTS CONTAINED IN THIS DOCUMENT ARE NOT SAFETY RATED. THEY ARE NOT DESIGNED OR RATED FOR ENSURING SAFETY OF PERSONS, AND SHOULD NOT BE RELIED UPON AS A SAFETY COMPONENT OR PROTECTIVE DEVICE FOR SUCH PURPOSES. Please refer to separate catalogs for OMRON's safety rated products.

OMRON shall not be responsible for conformity with any standards, codes, or regulations that apply to the combination of products in the customer's application or use of the product.

At the customer's request, OMRON will provide applicable third party certification documents identifying ratings and limitations of use that apply to the products. This information by itself is not sufficient for a complete determination of the suitability of the products in combination with the end product, machine, system, or other application or use.

The following are some examples of applications for which particular attention must be given. This is not intended to be an exhaustive list of all possible uses of the products, nor is it intended to imply that the uses listed may be suitable for the products:

- Outdoor use, uses involving potential chemical contamination or electrical interference, or conditions or uses not described in this document.

- Nuclear energy control systems, combustion systems, railroad systems, aviation systems, medical equipment, amusement machines, vehicles, safety equipment, and installations subject to separate industry or government regulations.
- Systems, machines, and equipment that could present a risk to life or property.

Please know and observe all prohibitions of use applicable to the products.

NEVER USE THE PRODUCTS FOR AN APPLICATION INVOLVING SERIOUS RISK TO LIFE OR PROPERTY WITHOUT ENSURING THAT THE SYSTEM AS A WHOLE HAS BEEN DESIGNED TO ADDRESS THE RISKS, AND THAT THE OMRON PRODUCT IS PROPERLY RATED AND INSTALLED FOR THE INTENDED USE WITHIN THE OVERALL EQUIPMENT OR SYSTEM.

PERFORMANCE DATA

Performance data given in this document is provided as a guide for the user in determining suitability and does not constitute a warranty. It may represent the result of OMRON's test conditions, and the users must correlate it to actual application requirements. Actual performance is subject to the OMRON Warranty and Limitations of Liability.

CHANGE IN SPECIFICATIONS

Product specifications and accessories may be changed at any time based on improvements and other reasons.

It is our practice to change model numbers when published ratings or features are changed, or when significant construction changes are made. However, some specifications of the product may be changed without any notice. When in doubt, special model numbers may be assigned to fix or establish key specifications for your application on your request. Please consult with your OMRON representative at any time to confirm actual specifications of purchased products.

DIMENSIONS AND WEIGHTS

Dimensions and weights are nominal and are not to be used for manufacturing purposes, even when tolerances are shown.

ERRORS AND OMISSIONS

The information in this document has been carefully checked and is believed to be accurate; however, no responsibility is assumed for clerical, typographical, or proofreading errors, or omissions.

PROGRAMMABLE PRODUCTS

OMRON shall not be responsible for the user's programming of a programmable product, or any consequence thereof.

COPYRIGHT AND COPY PERMISSION

This document shall not be copied for sales or promotions without permission.

This document is protected by copyright and is intended solely for use in conjunction with the product. Please notify us before copying or reproducing this document in any manner, for any other purpose. If copying or transmitting this document to another, please copy or transmit it in its entirety.

Precautions for Safe Use

Please observe the following precautions for safe use of the products.

(1) Installation Environment

- Do not use the product in environments where it can be exposed to inflammable/explosive gas.
- Install the Amplifier Unit in such a way that the ventilation holes are not blocked.
- To secure the safety of operation and maintenance, do not install the product close to high-voltage devices and power devices.
- During installation, make sure that screws are tightened firmly.

(2) Power Supply and Wiring

- The supply voltage must be within the rated range (DC24V±10%).
- Reverse connection of the power supply is not allowed.
- Open-collector outputs should not be short-circuited.
- Use the power supply within the rated load.
- High-voltage lines and power lines must be wired separately from this product. Wiring them together or placing them in the same duct may cause induction, resulting in malfunction or damage.

(3) Others

- Do not attempt to dismantle, repair, or modify the product.
- Dispose of this product as industrial waste.
- Should you notice any abnormalities, immediately stop use, turn OFF the power supply, and contact your OMRON representative.

Precautions for Correct Use

Please observe the following precautions to prevent failure to operate, malfunctions, or undesirable effects on product performance.

(1) Installation Location

Do not install the product in locations subjected to the following conditions:

- Ambient temperature outside the rating
- Rapid temperature fluctuations (causing condensation)
- Relative humidity outside the range of 35 to 85%
- Presence of corrosive or flammable gases
- Presence of dust, salt, or iron particles
- Direct vibration or shock
- Reflection of intense light (such as other laser beams or electric arc-welding machines)
- Direct sunlight or near heaters
- Water, oil, or chemical fumes or spray
- Strong magnetic or electric field

(2) Power Supply and Wiring

- When using a commercially available switching regulator, make sure that the FG terminal is grounded.
- If surge currents are present in the power lines, connect surge absorbers that suit the operating environment.
- Before turning ON the power after the product is connected, make sure that the power supply voltage is correct, there are no incorrect connections (e.g. load short-circuit) and the load current is appropriate. Incorrect wiring may result in breakdown of the product.
- Before connecting/disconnecting the Sensor Head, make sure that the Smart Sensor is turned OFF. The Smart Sensor may break down if the Sensor Head is connected or disconnected while the power is ON.
- Use extension cord ZFV-XC□B(R)V2 sold separately for extending the cord between the sensor head and amplifier unit. 2 ZFV-XC□B(R)V2 cords can be coupled together to extend the cord length. In addition, use a robot cable type extension cord (ZFV-XC□BRV2) at locations where the cord bends, to prevent damage to the cord.
- Use only combinations of Sensor Heads and Sensor Controllers specified in this manual.
- Do not turn the power OFF in the following instances
 - Immediately after the MENU mode or ADJ mode is switched to the RUN mode
 - While teaching with a parallel signal
 - Wait for the ENABLE signal to turn ON before turning the power OFF as the bank data may be initialized.

(3) Orientation when Installing the Amplifier Unit

To improve heat radiation, install the Amplifier Unit only in the orientation shown below.

Right

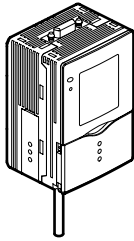

Do not install the Amplifier Unit in the following orientations.

Wrong

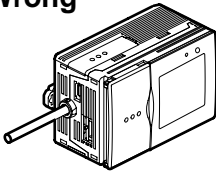

Wrong

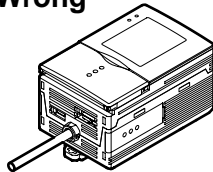

(4) Maintenance and Inspection

- Do not use thinner, benzene, acetone or kerosene to clean the Sensor Head and Amplifier Unit.
- If large dust particles adhere to the front Panel of the Sensor Head, use a blower brush (used to clean camera lenses) to blow them off. Do not blow the dust particles with your mouth.
- To remove smaller dust particles, wipe gently with a soft cloth. Do not use excessive force to wipe off dust particles. Scratches on the front Panel may cause errors.

(5) Optical Axis and Detection Range

The center of the guide light and detection range are for reference only.

The center of the optical axis sometimes differs according to each Sensor Head. During installation, be sure to check the center of the image and the detection range on the LCD monitor of the Amplifier Unit.

(6) Ventilation Film

- Do not peel off or probe the ventilation film with a sharp-pointed object. If you do, the specifications of the protective structure may no longer be satisfied.
- Do not block the ventilation film. Doing so might cause the front panel to be condensed.

Editor's Note

Page Format

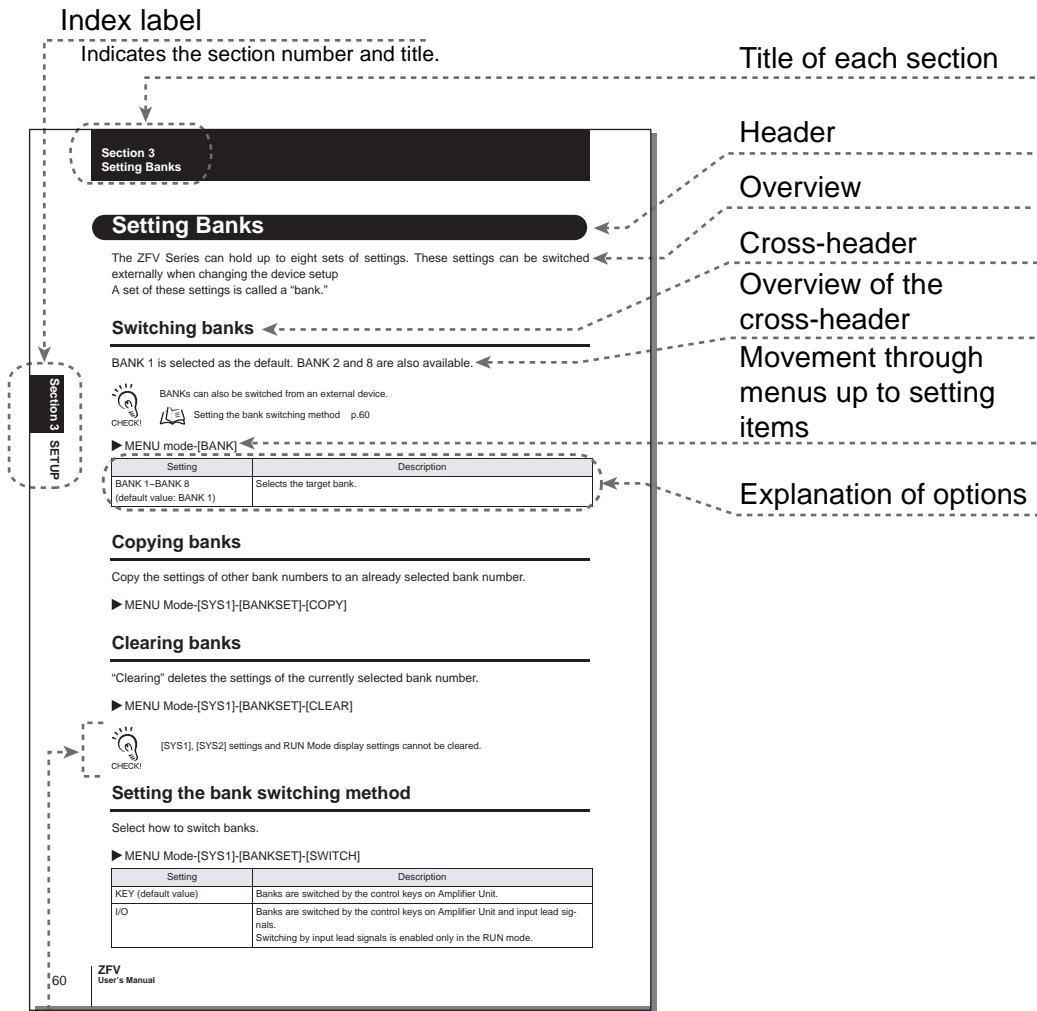

Supplementary Explanation

Helpful information regarding operation and reference pages are introduced here using symbols.



■ Meaning of Symbols

Menu items that are displayed on the Amplifier Unit's LCD screen are indicated enclosed by brackets [].

■ Visual Aids



CHECK!

Indicates points that are important to ensure full product performance, such as operational precautions and application procedures.



Indicates pages where related information can be found.



Indicates information helpful in operation.

EXP MENU

Indicates functions that can be set only when the setup menu has been switched to EXP menu.

CONTENTS

Precautions for Safe Use	4
Precautions for Correct Use	5
Editor's Note	7
Page Format	7
CONTENTS	9
SECTION 1 FEATURES	13
ZFV Smart sensor Features	14
Basic Configuration	16
Part Names and Functions	18
SECTION 2 INSTALLATION & CONNECTION	21
About Installation and Connection	22
Amplifier Unit	23
Attaching the ferrite core	23
Installing the Amplifier Unit	23
Gang mounting	27
About the I/O cable	31
Timing charts	34
Sensor Head	37
Attaching the ferrite core	37
Installing the mounting fixture	37
Installing the Sensor Head	38
Connecting the Sensor Head	40

SECTION 3	SETUP	41
	Setting Flow	42
	About Setup	44
	Basic Knowledge for Operation	44
	List of Setting Items in MENU mode	46
	Executing Teaching	48
	Teaching Flow	48
	Types of Teaching	51
	Adjusting Threshold Values	55
	Performing Measurement	59
	Setting Banks	60
	Switching banks	60
	Copying banks	60
	Clearing banks	60
	Setting the bank switching method	60
	Setting the System Environment	61
	Adjusting the measurement speed	61
	Selecting the measurement timing	61
	Selecting the teaching mode from an external device	61
	Setting/canceling the “Eco” mode	62
	Initializing setup data	62
	Initializing measurement data	62
	Checking the version	63
	Changing image capture timing on teaching screen	63
	Setting communications environment	64
	Changing the Input/output Conditions	65
	Selecting the ON conditions	65
	One-shot output	65
	Setting the ON delay time	66
	Setting the OFF delay time	67
	I/O Monitor Function	68
	Settings During Application Extended Connection	69
	Specifying the Amplifier Unit to input the trigger	69
	Setting the presence of Sensor Head	70

Setting output content	70
Customizing Measurement conditions	71
Common items	71
PATTERN/SEARCH, MATCH	72
BRIGHT	73
AREA	74
WIDTH	75
POSITION	76
COUNT	77
CHARA/CHARA 1, CHARA 2	78
Saving the Set Measurement Conditions	82
SECTION 4 APPENDIX	83
Troubleshooting	84
Error Messages and Remedies	85
Q&A	86
Run Mode Display Item List	87
When Gang-mounting Amplifier Units	89
Gang-mounting example	89
Rules of gang-mounting	90
Data route	91
Teaching process when gang-mounting	92
Integrating judgment output	93
Restrictions when gang-mounting old and new amplifier units	94
Specifications and External Dimensions	95
Sensor Head	95
Amplifier Unit	97
Panel Mount Adapters	100
Control Link Unit	101
Extension Cord	102
Version Up Information	103
INDEX	105
Revision History	108

Section 1

FEATURES

☒ ZFV Smart sensor Features	14
☒ Basic Configuration	16
☒ Part Names and Functions	18

ZFV Smart sensor Features

The ZFV sensor senses objects by its “surface.” How objects are being sensed can be easily set while verifying on the LCD monitor.

The ZFV also incorporates a 250,000-pixel CCD equivalent to that of a Conventional machine vision sensor. This allows presence detection and recognition of different objects, which have up till now been performed visually, to be executed fast and accurately.

- Recognition of top/rear side and orientation of electronic components

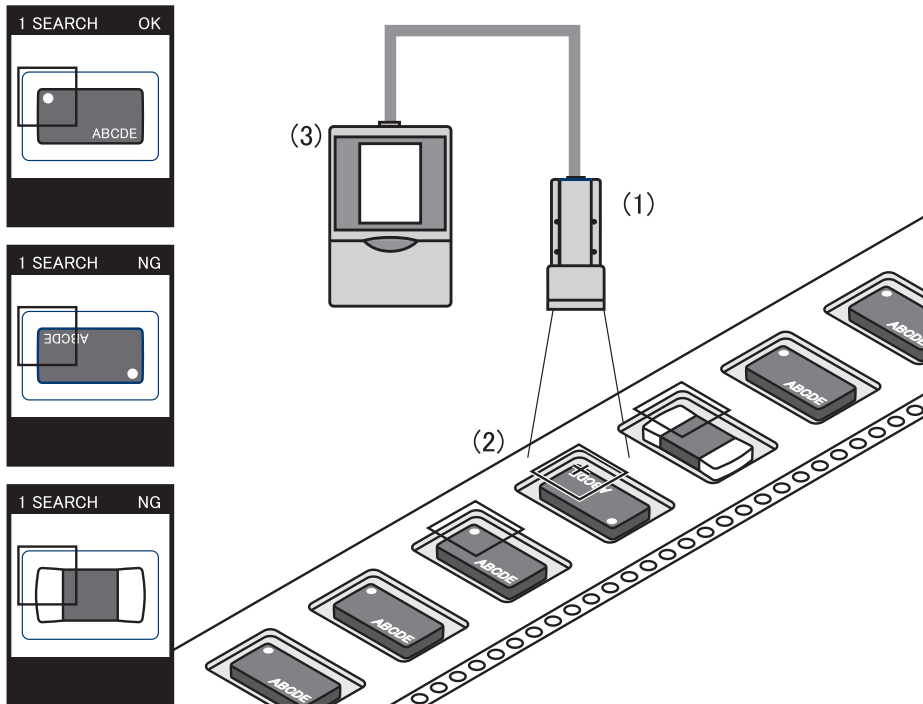

(1) Compact Sensor Head

The LED light emitting section and lens are built into the compact Sensor Head. The Sensor Head takes up little installation space.

(2) Easy Installation and Adjustment

The range that can be sensed by Sensor Head can be confirmed by the guide light. So, the Sensor Head can be installed by viewing the position of the guide light and its focus.

(3) Business Card-size Amplifier Unit

- The Amplifier Unit is designed to be compact so that it can be installed at a wide range of sites.

 Specifications and External Dimensions p.95

- Outstanding operate ease has been achieved by a 1.8" color LCD motor, an industry-first icon-based menu, and simple key layout.

 Basic Knowledge for Operation p.44

- The ZFV incorporates an extensive range of measurement items which means that numerous applications are supported.

 Types of Teaching p.51

(4) Logging measured images (Ver. 2.0 and later)

Measurement images can be logged by connecting to data storage unit ZS-DSU. Set NG occurrence as a trigger to log before/after images and measurement values. This is useful for investigating the cause of defectives. Logged data is saved to the memory card inserted into the data storage unit, and can be easily be loaded to a personal computer.

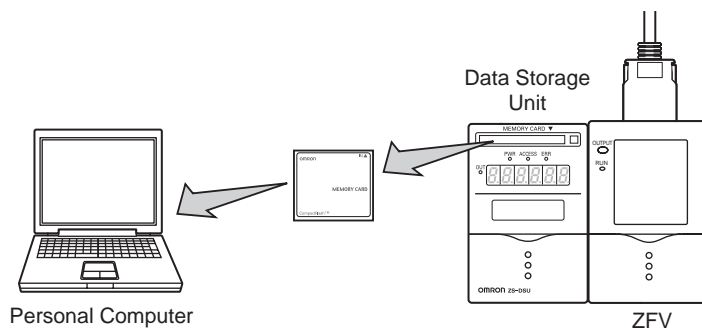

 Data storage unit ZS-DSU User's Manual

(5) Enables bank extension (Ver. 2.0 and later)

A maximum 128 bank data items can be saved to the memory card mounted to the data storage unit if connected to data storage unit ZS-DSU. Bank data can be transferred from the data storage unit to the ZFV as needed for the device setup.

 Data storage unit ZS-DSU User's Manual

Basic Configuration

The figure below shows the Basic Configuration of the ZFV Series.

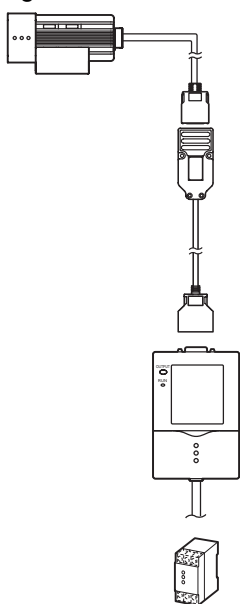

Sensor Head

Detects workpieces as images.

- Narrow view type ZFV-SR10
- Wide view type ZFV-SR50

Extension Cord

ZFV-XC3BV2(3m)/XC8BV2(8m)/XC3BRV2(3m)

Used between a Sensor Head and Amplifier Unit.

Two ZFV-XC□B(R)V2 cords can be coupled together to extend the cord length.

Amplifier Unit

Used for confirming images and menus, performing measurement processing, and outputting the result of processing.

- Single-function type ZFV-A10/-A15
- Standard type ZFV-A20/-A25

Power supply

DC24V (+10%, -15%)

Recommended OMRON power supply

(1) When 1 Amplifier Unit is connected

S82K-01524 (DC24V, 0.6A)

(2) When 2 or 3 Amplifier Units are connected

S82K-05024 (DC24V, 2.1A)

(3) When 4 or 5 Amplifier Units are connected

Prepare the required number of (1) and (2) power supplies above.

Application Expanded Configuration

Up to five Amplifier Units can be gang-mounted.

When the Amplifier Unit is gang-mounted, a wider range of applications can be supported as simultaneous processing of multiple areas and measurement items can be combined.

The image captured by the Sensor Head is transferred to the leftmost Amplifier Unit, so connect to the rightmost Amplifier Unit.

Right

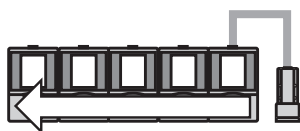

Right

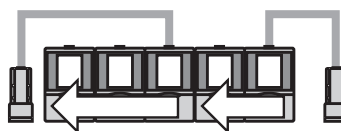

Wrong

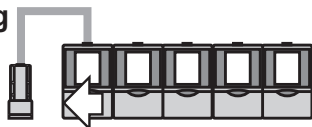

Wrong



- The maximum number of Amplifier Units that can be connected is five regardless of the number of connected Sensor Heads. Six or more Amplifier Units cannot be connected.
- Provide power to all gang-mounted Amplifier Units.

● Example 1

In this configuration, multiple parts of an image from a single Sensor Head are measured and multiple inspection item are performed.

Example) Inspection of the number of leads

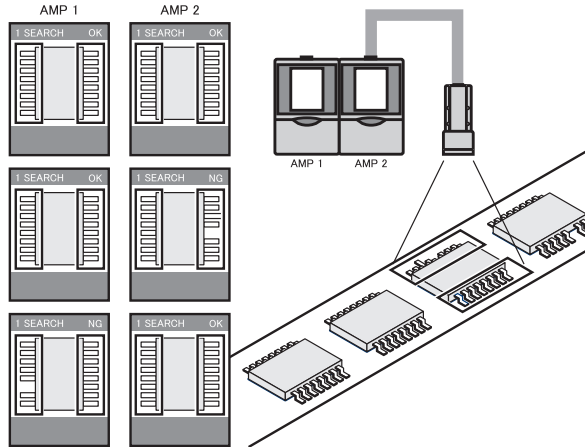

● Example 2

In this configuration, multiple Sensor heads are used to simultaneously inspect multiple locations on a workpiece.

When the TRIG signal is input from a single specified Amplifier Unit, the connected Amplifier Unit starts sensing immediately. The result of sensing is integrated on the Amplifier Unit to which the TRIG signal was input, and is output as a total judgment result.

Example) Alignment of products

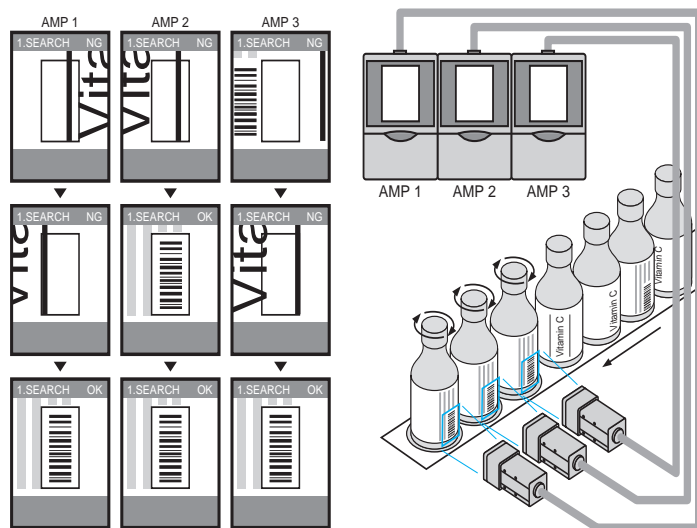

Part Names and Functions

The following describes the names and functions of parts on the Amplifier Unit and Sensor Head.

■ Amplifier Unit

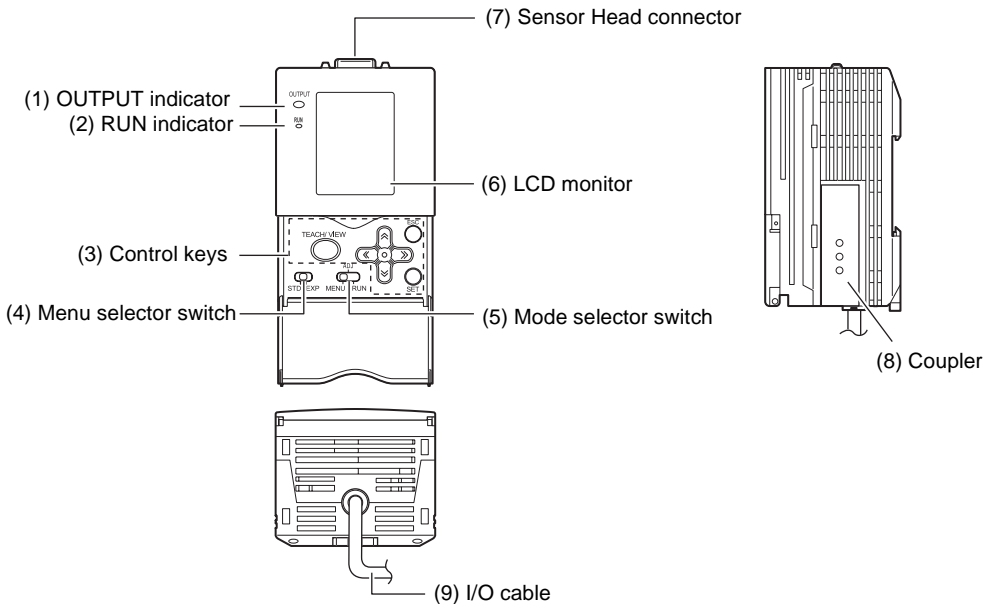

(1) OUTPUT indicator

The Output indicator lights when the OUTPUT signal turns ON.

(2) RUN indicator

The RUN indicator turns ON in the RUN mode.

(3) Control keys

The Control Keys are for setting measurement conditions and other information.



Displays and Key Operations p.45

(4) Menu selector switch

This switch selects the setup menu.

STD...Standard menu. Select this when setting the minimum required items for measurement.

EXP...Expert menu. Select this item when making a more detailed setup.

(5) Mode selector switch

This switch selects the operating mode.

MENU...Select this mode when setting measurement conditions.

ADJ...Select this mode when adjusting the judgment threshold value.

RUN...Select this mode when performing measurement.

Output is performed only when the RUN mode is currently selected.

(6) LCD monitor

The LCD monitor displays setup menus and images captured from the Sensor Head.

(7) Sensor Head connector

This connector connects the Sensor Head.

(8) Coupler

This connector is used to connect two or more Amplifier Units. It is located on both sides of the Amplifier Unit.

(9) I/O Cable

The I/O cable connects the Amplifier Unit to the power supply and external devices, such as timing sensors or programmable controllers.

■ Sensor Head

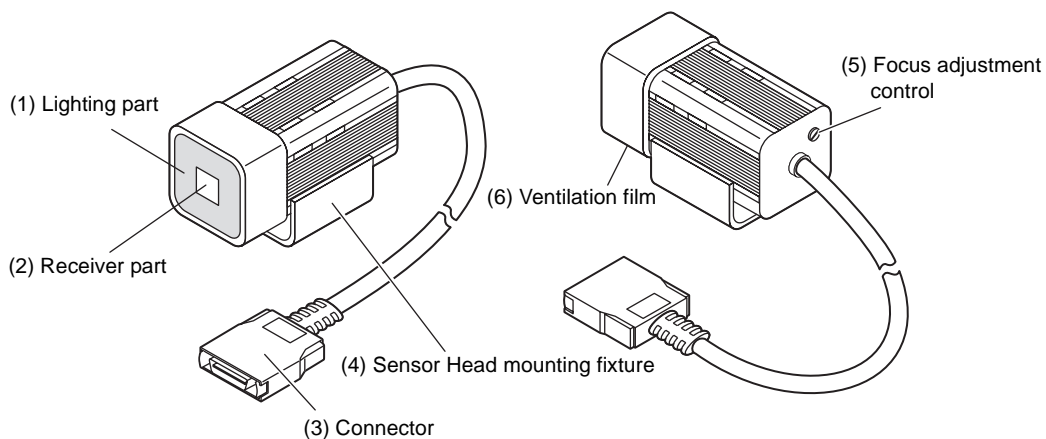

(1) Lighting part

This section emits light.

(2) Receiver part

This section captures the image.

(3) Connector

This connector is connected to the Amplifier Unit.

(4) Sensor Head mounting fixture

This fixture is for mounting the Sensor Head.

This fixture can be mounted on all of the four mounting surfaces.

(5) Focus adjustment control

This control is used for adjusting the focus of the image.

(6) Ventilation film

This film prevents the front panel from condensation.

Section 2

INSTALLATION & CONNECTION

☒ About Installation and Connection	22
☒ Amplifier Unit	23
Attaching the ferrite core	23
Installing the Amplifier Unit	23
Gang mounting	27
About the I/O cable	31
Timing charts	34
☒ Sensor Head	37
Attaching the ferrite core	37
Installing the mounting fixture	37
Installing the Sensor Head	38
Connecting the Sensor Head	40

About Installation and Connection

■ Checking the installation environment

Read “Precautions for Safe Use” at the beginning of this manual, and check the installation environment.

■ Checking the installation site

Read “Precautions for Correct Use” at the beginning of this manual, and check the installation site.

■ About the power supply

Before installing and connecting the Smart Sensor, be sure to turn it OFF. Also read “Precautions for Safe Use” and “Precautions for Correct Use” at the beginning of this manual, and check the power supply and wiring.

Amplifier Unit

This section describes installation of the Amplifier Unit, and connection of the I/O cable.



Before connecting/disconnecting peripheral devices, make sure that the Smart Sensor is turned OFF. The Smart Sensor may break down if the Smart Sensor is connected or disconnected while the power is ON.

Attaching the ferrite core

Attach the ferrite core (provided with the Smart Sensor) to the I/O cable of the Amplifier Unit.

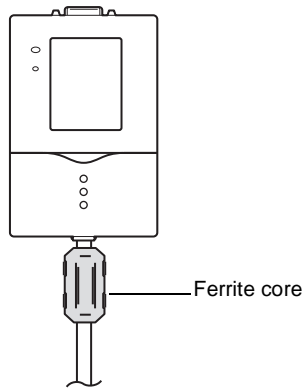

Installing the Amplifier Unit

■ Installing on the DIN track

Amplifier Units can be easily mounted on the 35-mm DIN track.

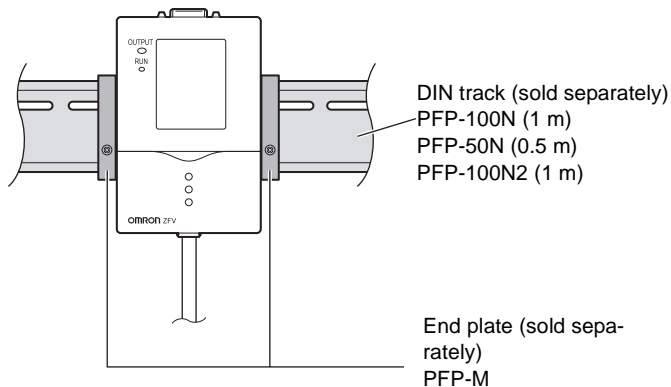

● Installation procedure

1. Hook the connector end of the Amplifier Unit onto the DIN track.

2. Push the Amplifier Unit down onto the DIN track until the hook on the I/O cable side is locked.

Push down until you hear it snap into place.

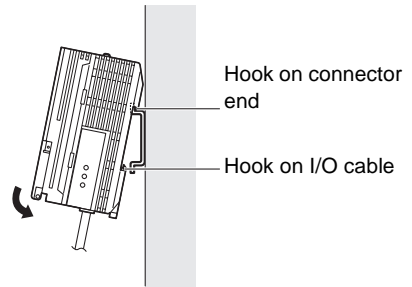

Always hook the connector end of the Amplifier Unit on the DIN track first. Hooking the I/O cable end on the DIN track first may impair the mounting strength of the DIN track attachment.

● Removal procedure

The following describes how to remove the Amplifier Unit from the DIN track.

1. Pull the hook on the I/O cable end of the Amplifier Unit downwards.

2. Lift up the Amplifier Unit from the I/O cable end, and remove it from the DIN track.

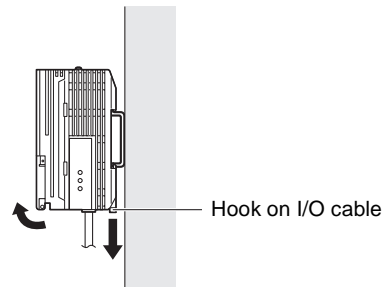

■ Mounting on a panel

The Panel Mount Adapters (sold separately ZS-XPM1) can be used to mount the Amplifier Unit on a panel.

 Panel Mount Adapters p.100

1. Push out the Amplifier Unit from the rear of the panel towards the front.

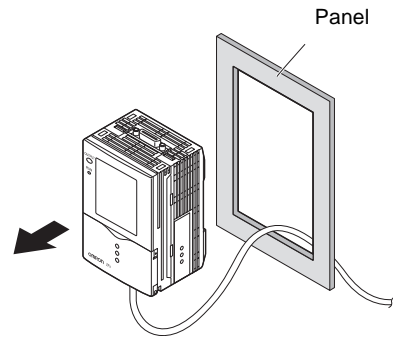

2. Install the small Mount Adapters on the four holes on the Amplifier Unit.

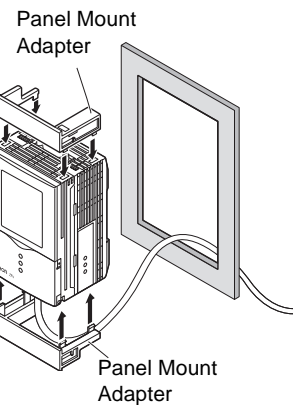

3. Install the long Mount Adapters on the two holes on the small Mount Adapter.

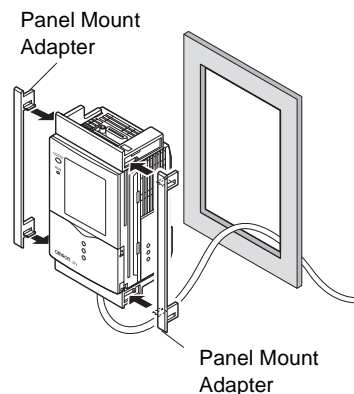

- 4. Install the Amplifier Unit with Mount Adapters attached onto the panel from the front.**



Take care not to pinch the I/O cable.

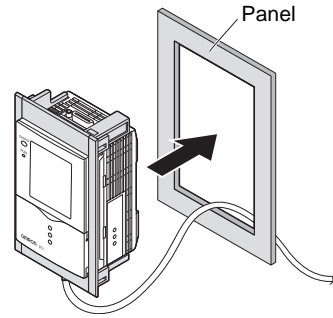

- 5. Hook the hooks of the mounting fixture onto the two holes of the smaller Mount Adapters and tighten the screws.**

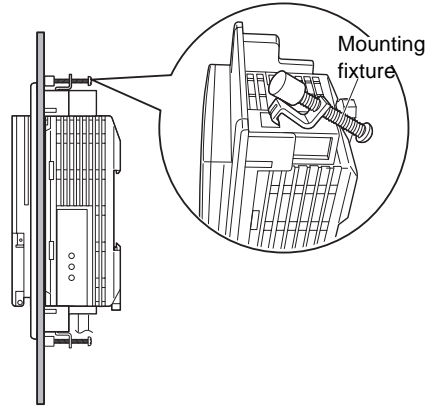

- 6. Make sure that the Amplifier Unit is firmly fixed on the panel.**

Gang mounting

Up to five Amplifier Units can be gang-mounted.

 Application Expanded Configuration p.16

■ Installing on the DIN track

Amplifier Units can be easily mounted on the 35-mm DIN track.

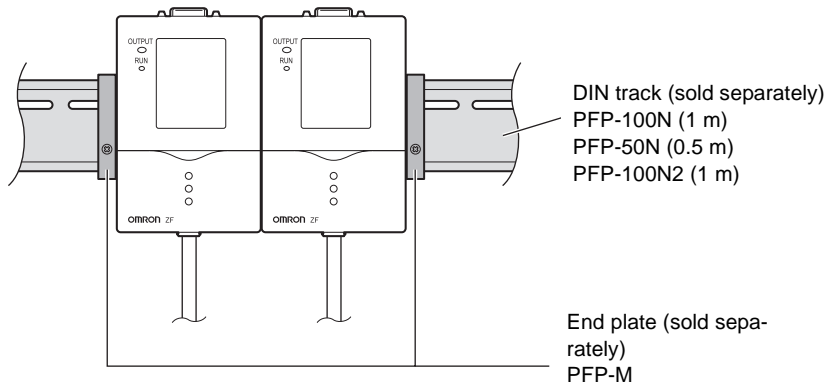

● Installation procedure

1. Install Amplifier Unit on the DIN track.

 p.24

2. Open the connector cover on the Amplifier Unit.

Slide the cover to remove.

3. Insert the Controller Link Unit into the connector on the Amplifier Unit.

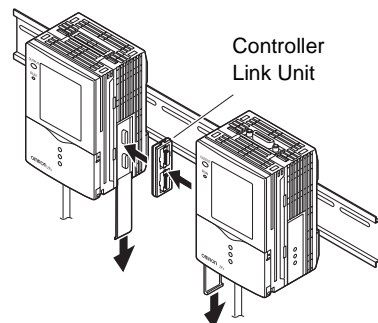

4. Slide the Amplifier Unit, and insert into the connector on the Controller Link Unit.

● Removal procedure

1. Slide the Amplifier Unit, and remove from the connector on the Controller Link Unit.
2. Slide the Controller Link Unit and remove from the connector on the Amplifier Unit.
3. Install the cover on the coupler of the Amplifier Unit.
4. Pull the hook on the I/O cable end downwards.
5. Lift up the Amplifier Unit from the I/O cable end, and remove it from the DIN track.

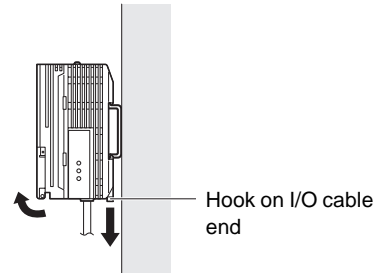
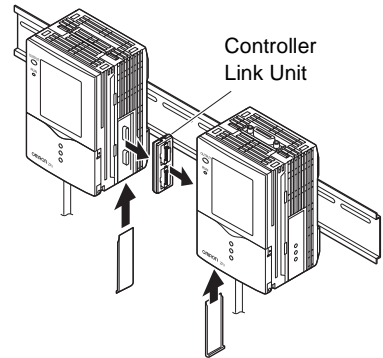

■ Mounting on a panel

The Panel Mount Adapters (sold separately ZS-XPM1/XPM2) can be used to mount the Amplifier Unit on a panel.

 Panel Mount Adapters p.100

1. Install the Amplifier Unit on the DIN track.

 p.27



When mounting on a panel, be sure to install the DIN track on the rear side of the Amplifier Unit for support.

CHECK!

2. Push out the Amplifier Unit from the rear of the panel towards the front.

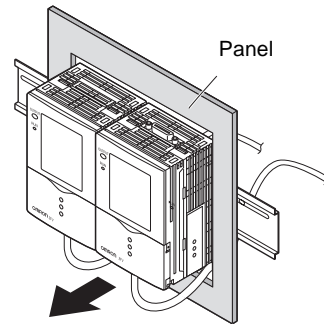

3. Install the small Mount Adapters on the four holes on the Amplifier Unit.



Install the small Mount Adapters on all gang-mounted Amplifier Units.

CHECK!

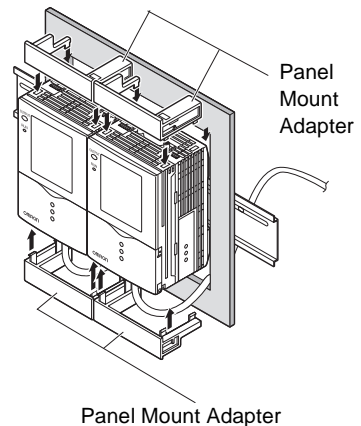

4. Install the long Mount Adapters on the two holes on the small Mount Adapter.



Install the long Mount Adapters only on both sides of gang-mounted Amplifier Units.

CHECK!

Panel Mount Adapters

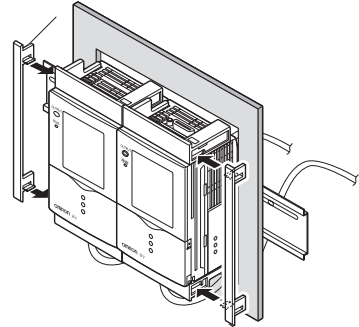

Panel Mount Adapters

5. Install the Amplifier Unit with Mount Adapters attached onto the panel from the front.



Take care not to pinch the I/O cable.

CHECK!

Panel

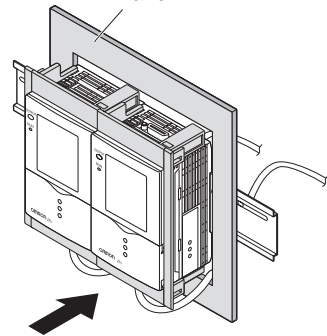

6. Hook the hooks of the mounting fixture onto the two holes of the smaller Mount Adapters and tighten the screws.



Attach two mounting fixtures each on all gang-mounted Amplifier Units.

CHECK!

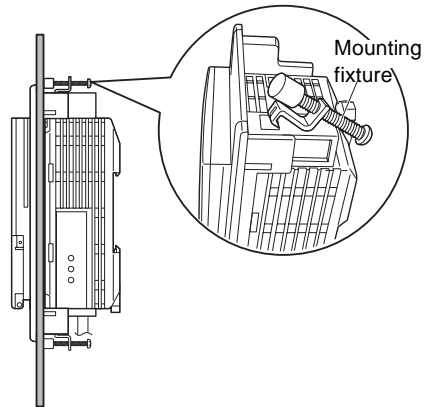

7. Make sure that the Amplifier Units are firmly fixed on the panel.

About the I/O cable

The following shows the leads that comprise the I/O cable.

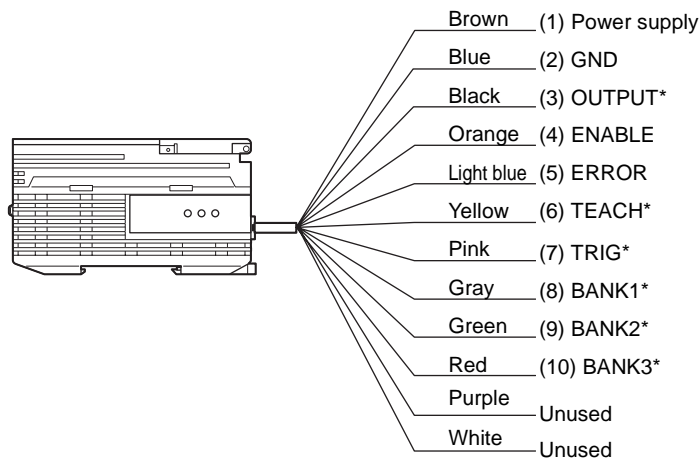

* : Enabled only in the RUN mode

(1) Power supply

This connects the power supply.

Supply power from a DC power supply unit that has a countermeasure (safety ultra-low voltage circuit) built-in for preventing high voltages from occurring.



Recommended power supply unit p.16

Wire the power supply separately from other devices. Wiring them together or placing them in the same duct may cause induction, resulting in malfunction or damage.

(2) GND

The GND terminal is the 0V power supply terminal.

(3) OUTPUT (control output)

This outputs judgment results. This lead is interlocked with OUTPUT LED.

(4) ENABLE (enable output)

This turns ON when the sensor is ready for measurement.

(5) ERROR (error output)

This turns ON when an error is generated.



Error Messages and Remedies p.85

(6) TEACH (teaching input)

There are two teaching modes, workpiece stop teaching and workpiece move teaching. These teaching modes can be selected in the menu.

 Selecting the teaching mode from an external device p.61

(7) TRIG (measurement trigger input)

There are two measurement modes, synchronous measurement and continuous measurement. Which mode of measurement is to be performed in is selected in the menu.

 Selecting the measurement timing p.61

(8) BANK1 (bank switching input 1)

(9) BANK2 (bank switching input 2)

(10) BANK3 (bank switching input 3)

 Bank switching p.36

 Timing charts p.34

■ I/O Circuit Diagrams

● NPN output type (ZFV-A10/A20)

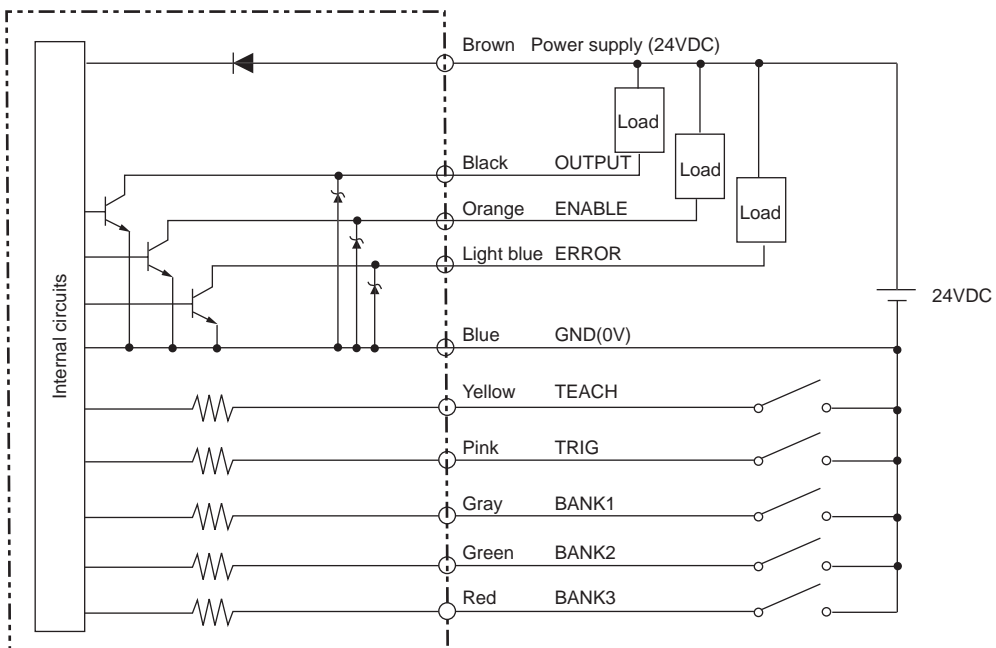

● PNP output type (ZFV-A15/A25)

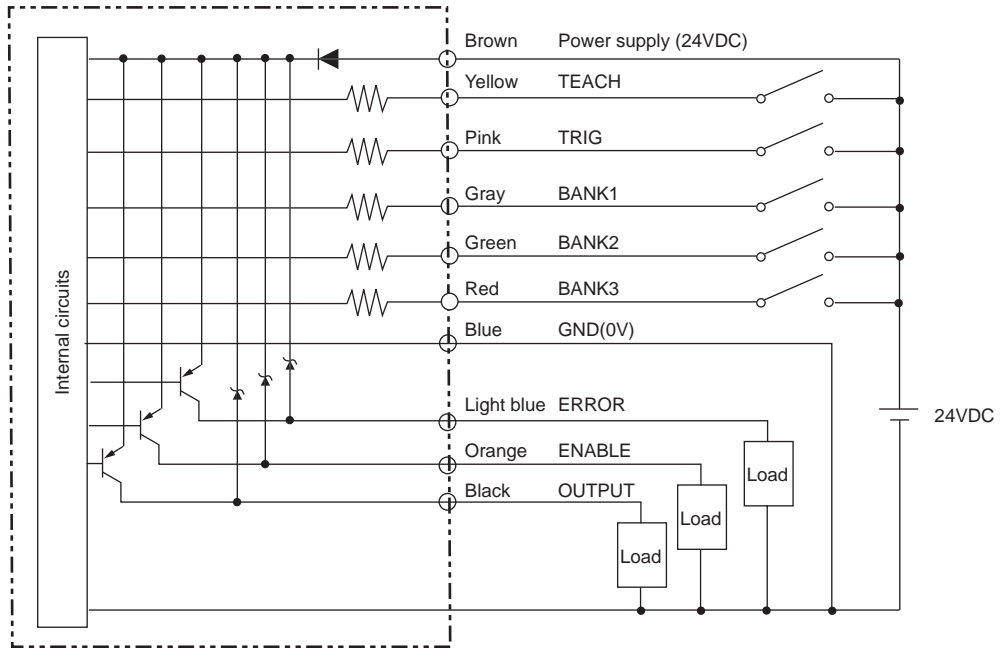

Timing charts

The following shows the timing charts when communication is performed with external devices.

■ Measurement

● Continuous measurement

Measurement is performed continuously for the duration that the TRIG signal is ON. The measurement result is updated, and output to external devices at each measurement cycle.

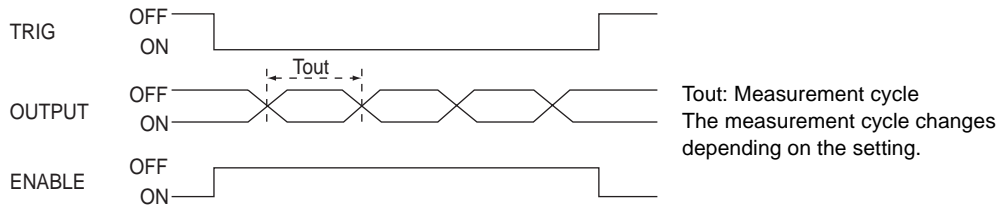

● Synchronous measurement

Measurement is performed only once in synchronous with the change in TRIG signal state from OFF to ON, and the result is output.

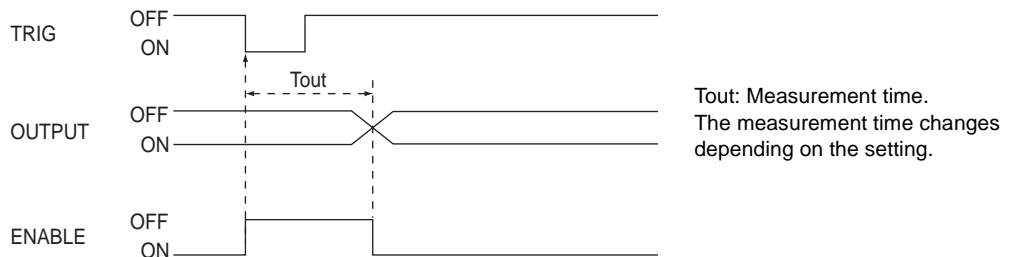

- The minimum ON width of the TRIG signal is 1 ms.
- The OUTPUT signal is held until the next measurement result is updated.
Note, however, that when one-shot output is currently set, the OUTPUT signal is held for the preset time.



One-shot output p.65

■ Teaching

● Workpiece stop teaching

Teaching processing is performed according to TRIG signal input after the TEACH signal is input from the outside.

Measurement is not performed while teaching is being performed.

Do not move the workpiece until teaching is completed.

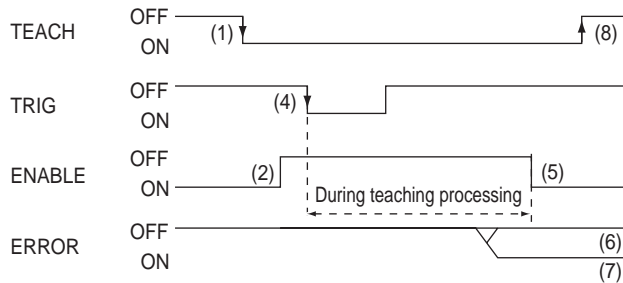

- (1) Turn the TEACH signal ON.
- (2) Confirm that the ENABLE signal has turned OFF.
- (3) Make sure that the workpiece to be taught is in the teaching area.
- (4) Input the TRIG signal from the outside.
- (5) The ENABLE signal turns ON after teaching is completed. At this timing, check the state of the ERROR signal.
- (6) When teaching has been completed successfully, the ERROR signal stays OFF.
- (7) When teaching fails, the ERROR signal turns ON.
- (8) Turn the TEACH signal OFF, and end teaching processing.
When teaching fails, the state before teaching was initiated is returned to. Perform teaching again.
If the TEACH signal is turned OFF midway, teaching is disabled.

● Workpiece move teaching

Use this teaching mode when the object cannot be stopped.

Teaching processing is divided up and performed in synchronous with the TRIG signal input after the TEACH signal is input from the outside.

Teaching must be processed six times.

Measurement is not performed while teaching is being performed.

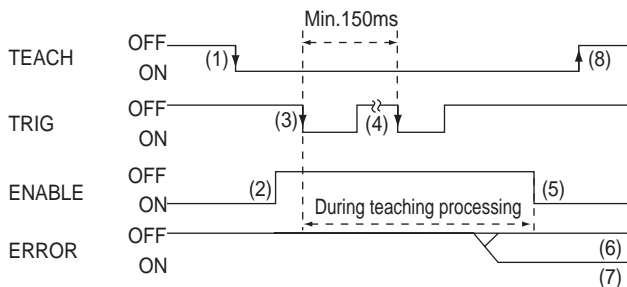

- (1) Turn the TEACH signal ON from the outside.
- (2) Confirm that the ENABLE signal has turned OFF.
- (3) Input the TRIG signal at the timing for measuring the workpiece to be taught.
- (4) Repeat the input in step (3) six times. (Trigger inputs from the seventh time onwards are ignored.)
- (5) The ENABLE signal turns ON after teaching is completed. Check the state of the ERROR signal at this timing.
- (6) When teaching has been completed successfully, the ERROR signal stays OFF.
- (7) When teaching fails, the ERROR signal turns ON.
- (8) Turn the TEACH signal OFF, and end teaching processing.
When teaching fails, the state before teaching was initiated is returned to. Perform teaching again.
If the TEACH signal is turned OFF midway, teaching is disabled.

■ Bank switching

The bank No. can be switched when BANK1 to BANK3 are connected as follows.

Bank No.	BANK1	BANK2	BANK3
BANK1	OFF	OFF	OFF
BANK2	ON	OFF	OFF
BANK3	OFF	ON	OFF
BANK4	ON	ON	OFF
BANK5	OFF	OFF	ON
BANK6	ON	OFF	ON
BANK7	OFF	ON	ON
BANK8	ON	ON	ON

Sensor Head

This section describes how to install and connect the Sensor Head.

Attaching the ferrite core

Attach the ferrite core (provided with the Smart Sensor) to the connector side of the Sensor Head.

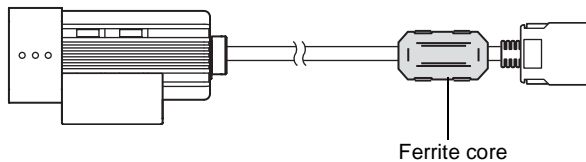

Installing the mounting fixture

Attach the mounting fixture (provided with the Smart Sensor) to the side of the Sensor Head.

■ Installation procedure

The mounting fixture can be installed on all of the four mounting surfaces.

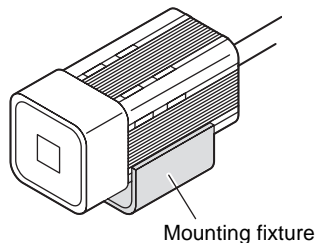

1. Align the two hooks on one side of the mounting fixture with the two grooves on the Sensor Head body (light emitting side).

2. Press in the other hook.

Push down until you hear it snap into place.

3. Make sure that the mounting fixture is firmly fixed on the Sensor Head.

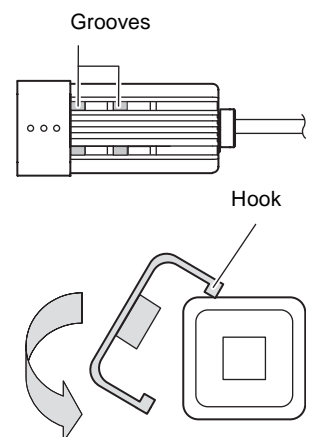

■ Removal procedure

Insert a regular screwdriver into the gap (one of the two gaps) between the mounting fixture and the Sensor Head case, and remove the mounting fixture.

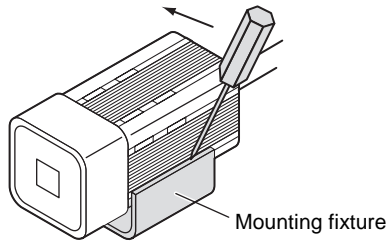

Installing the Sensor Head

This section describes how to install the Sensor Head.

The detection range of the Sensor Head can be confirmed by the guide light. Install so that the part to be inspected is inside the frame formed by the guide light.

■ Installation distance

The following graphs show the relationship between detection range and setting distance for each model of Sensor Head.

Values differ according to each model of Sensor Head, so fully check the model before using these graphs.

Reading graphs

"H" refers to the following width.

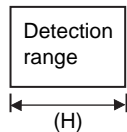

Details of detection range



• ZFV-SR10

Setting distance L (mm)

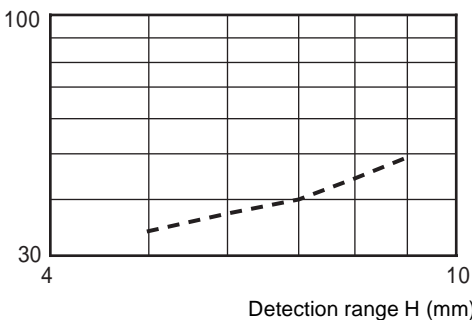

Detection range H (mm)	Setting distance L (mm)
5	34
6	37
7	40
8	44
9	49

• ZFV-SR50

Setting distance L (mm)

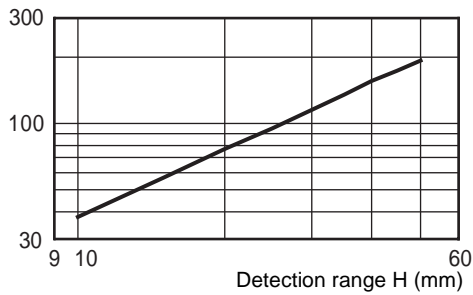

Detection range H (mm)	Setting distance L (mm)
10	38
15	57
20	76
25	95
30	115
35	134
40	157
45	174
50	194

(Example)

When using a ZFV-SR50 Sensor Head at a detection range of 25 mm required for the location of the sensing object, the setting distance of Sensor Head becomes 95mm.

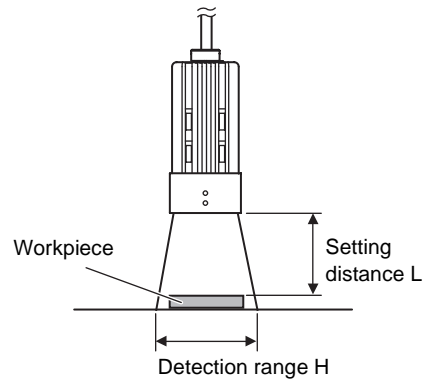

● About installation for reflective workpieces

Install the Sensor Head at an angle to prevent mirror reflection light from being picked up by the sensor.

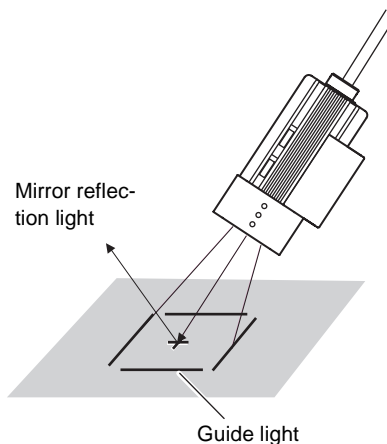

■ Installation procedure

1. Install the Sensor Head at the installation distance obtained in the above graphs.
2. Turn the focus adjustment control to the left and right to adjust the focus.

Focus can be verified by the green guide light. Adjust so that the guide light is fine toned.

- Turn to right: Focuses to the far side.
- Turn to left: Focuses to the near side.

Default is focus set at furthest point.

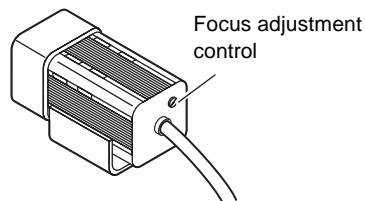

Before turning the focus adjustment control slightly to the left and right, make sure that the guide light is not at the upper or lower limit positions. The focus adjustment control is a multi-turn variable resistor. However, the control stops turning at the upper or lower limit positions. Do not exert unnecessary force to turn the control at the upper or lower limit positions as this might damage the control.

Connecting the Sensor Head

This section describes how to connect the Amplifier Unit.



- Before connecting/disconnecting the Sensor Head, make sure that the Amplifier Unit is turned OFF. The Sensor Head may break down if the Sensor Head is connected or disconnected while the power is ON.
- Do not touch the terminals inside the connector.
- Ensure that the connector is secure, i.e., not subject to vibration or impact.

■ Connecting the Sensor Head

Insert the Sensor Head connector into the Sensor Head connector of the Amplifier Unit.

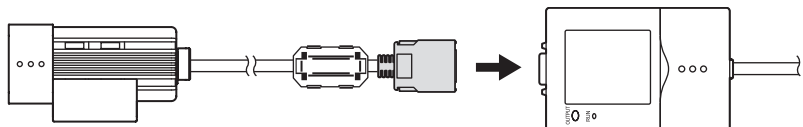

■ Disconnecting the Sensor Head

Pull out the Sensor Head while pressing in the hooks on both sides of the Sensor Head connector.

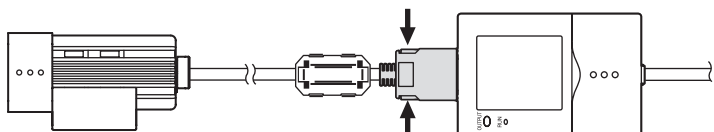

Section 3

SETUP

☒	Setting Flow	42
☒	About Setup	44
	Basic Knowledge for Operation	44
	List of Setting Items in MENU mode	46
☒	Executing Teaching	48
	Teaching Flow	48
	Types of Teaching	51
☒	Adjusting Threshold Values	55
☒	Performing Measurement	59
☒	Setting Banks	60
☒	Setting the System Environment	61
	Adjusting the measurement speed	61
	Selecting the measurement timing	61
	Selecting the teaching mode from an external device	61
	Setting/canceling the “Eco” mode	62
	Initializing setup data	62
	Initializing measurement data	62
	Checking the version	63
	Changing image capture timing on teaching screen	63
	Setting communications environment	64
☒	Changing the Input/output Conditions	65
☒	I/O Monitor Function	68
☒	Settings During Application Extended Connection	69
☒	Customizing Measurement conditions	71
	Common items	71
	PATTERN/SEARCH, MATCH	72
	BRIGHT	73
	AREA	74
	WIDTH	75
	POSITION	76
	COUNT	77
	CHARA/CHARA 1, CHARA 2	78
☒	Saving the Set Measurement Conditions	82

Setting Flow

Preparation for Measurement

Installation and Connection

Set the Sensor Head and Amplifier Unit.



SECTION 2
INSTALLATION & CONNECTION p.22



Power ON

Adjusting the Image

Adjust the focus of the image.



SECTION 2
INSTALLATION & CONNECTION p.38



Setting of Measurement Conditions

(Only when Amplifier Units are gang-mounted)

Settings in an application extended connection

Set the processing details for each Amplifier Units.



p.69



Executing Teaching

Execute teaching, and register the judgement criteria.



Key Operation Teaching p.48
External Signal Input Teaching p.35



External I/O

Set how to output the measurement values.



p.65



Applying Settings, Performing Measurement

Adjusting threshold values

Adjust the threshold values for judging the measurement result.



p.55

Saving the set measurement conditions



p.82

Perform Measurement



p.59



CHECK!

Set measurement conditions are saved to the amplifier unit "when external TEACH signal teaching is successful" or "when switched to RUN mode." When the TEACH key is pressed from the teaching screen to teach, contents will not be saved unless switched to RUN mode once. Changed contents, including teaching results, are cleared when switching off without saving.

Applied Use of Functions

Setting Banks

Use multiple banks for changeover.



p.60

Setting Up the System Environment



Adjusting the measurement speed p.61
 Selecting the measurement timing p.61
 Selecting the teaching mode from an external device p.61
 Setting/canceling the "Eco" mode p.62

Advanced Setup

Changing the Input/Output Conditions



p.65

Customizing Measurement Conditions



p.71

Additional Functions

Changing the display image

Change the details to display on the LCD monitor during measurement.



p.59

Clearing all data

Initialize the Amplifier Unit.



p.62

Checking the Version

Confirm the version of the Amplifier Unit.



p.63

When a Problem Occurs



The Smart Sensor does not operate correctly

Troubleshooting p.84



An error message has appeared

Error Messages and Remedies p.85



If you have a query

Q&A p.86

About Setup

Basic Knowledge for Operation

Switching Modes

There are 3 operating modes as follows. Switch to the desired mode before you start operation. To switch the operating mode, use the mode switch.

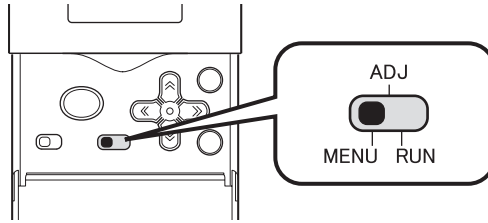

Mode	Description
MENU mode	This mode is for executing teaching or setting up the measurement conditions.
ADJ mode	This mode is for setting the judgment threshold values.
RUN mode	This mode is for performing actual measurement.

Switching Menus

There are two setup menus in the MENU mode. Switch the menu according to your specific requirements.

To switch the menu, use the menu selector switch.

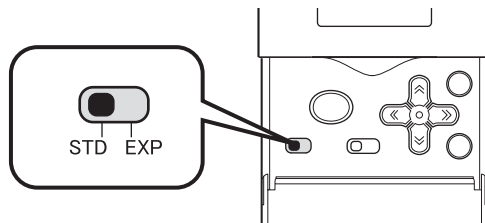

Setup Menu	Description
STD menu	This is the standard menu. First, set the measurement conditions in this menu.
EXP menu	This is the expert menu. Switch to this menu to make a more advanced setup.

■ Displays and Key Operations

Make setups using the control keys while viewing the menus and the image displayed on the LCD monitor.

● Display

The details that are displayed differ according to the operating mode.

• MENU mode

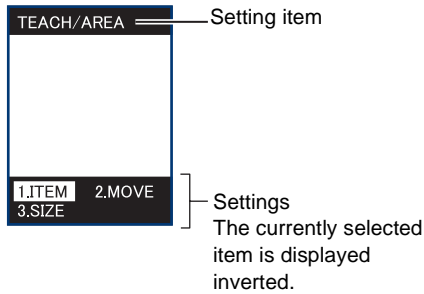



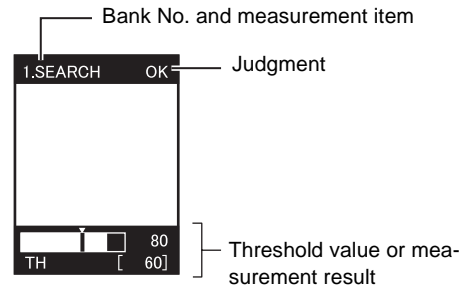

• ADJ mode/RUN mode

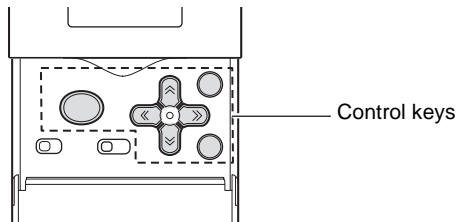

● Key Operations



Key	Description
← LEFT key → RIGHT key	 <p>The function of these keys differs according to the operating mode. In MENU mode: Moves through menus. In ADJ mode: Changes the adjustment item (type of threshold value). In RUN mode: Changes the display details (type of measurement value).</p>
↑ UP key ↓ DOWN key	 <p>The function of these keys differs according to the operating mode. In MENU mode: Moves between menus, selects parameters, and sets numerical values. In ADJ mode: Changes numerical values.</p>
TEACH/VIEW key	 <p>The function of these keys differs according to the operating mode. In MENU mode: Executes teaching. In RUN and ADJ modes: Switches the screen display.</p>
SET key	 <ul style="list-style-type: none"> • Selects menus. • Selects/applies items.
ESC key	 <p>Returns to the previous menu.</p>

List of Setting Items in MENU mode

The following shows the setting items in MENU mode

The details that are displayed differ according to the currently selected setup menu (STD or EXP). Switch the setup menu by the menu selector switch according to your specific requirements.

MENU Mode		Setting content	Default value	Selection item/Setting range	Pages	
TEACH	ITEM	PATTERN	-	SEARCH, MATCH	p.51	
		BRIGHT	-	-	p.52	
		AREA ^(*1)	-	-	p.52	
		WIDTH ^(*1)	-	-	p.53	
		POSITION ^(*1)	-	-	p.53	
		COUNT ^(*1)	-	-	p.53	
		CHARA ^(*1)	-	CHARA 1, CHARA 2	p.54	
	(*1)These menus are displayed only on standard type Amplifier Unit.					
			MOVE	-	-	p.48
			SIZE	-	-	p.48
BANK		BANK	BANK1	BANK1 to BANK8	p.60	
SYS1	BANKSET	COPY	-	-	p.60	
		CLEAR	-	-	p.60	
		SWITCH	KEY	KEY, I/O	p.60	
			IMAGE RATE	NORMAL	FINE, NORMAL, HIGH SPEED	p.61
			MEAS TYPE	TRIG	TRIG, CONTINUE	p.61
			TEACH TYPE	STATIONARY	STATIONARY, MOVING	p.61
			ECO MODE	ON	ON, OFF	p.62
CUSTOM ^(*2)		LIGHT	-	-	p.71	
EXP MENU	[ITEM]:[SEARCH]	SEARCH AREA	-	-	p.72	
		ROTATION	±10°	±10°, ±20°, ±30°, ±45°	p.72	
	[ITEM]:[MATCH]	SEARCH AREA	-	-	p.72	
	[ITEM]:[BRIGHT]	METHOD	AVERAGE	AVERAGE, DEVIATION	p.73	
	[ITEM]:[AREA]	COLOR	WHITE	BLACK, WHITE	p.74	
		BINARY	-	0 to 255	p.74	
	[ITEM]:[WIDTH]	COLOR	WHITE	BLACK, WHITE	p.75	
		DIRECTION	↔	↑, ↔	p.75	

(*2)The display details of items from [CUSTOM] onwards differ according to the item selected at [ITEM].

	Setting content	Default value	Selection item/Setting range	Pages
[ITEM]:[POSITION]	COLOR	WHITE	BLACK, WHITE	p.76
	DIRECTION	→	↑, ↓, →, ←	p.76
	EDGE SENSE	NORMAL	SENSITIVE, NORMAL, ROUGH	p.76
[ITEM]:[COUNT]	COLOR	WHITE	BLACK, WHITE	p.77
	DIRECTION	→	↓, →	p.77
[ITEM]:[CHARACTER1] MODE DTL	MODE	-	NONE, MODEL, EDGE	p.79
	MODEL	-	-	p.79
	COLOR	BLACK	BLACK, WHITE	p.80
	DIRECTION	↑	↑, ↓, →, ←	p.80
	SEARCH AREA	-	-	p.81
[ITEM]:[CHARACTER2] MODE DTL	MDL DIV	1LINE NORMAL	1LINE SHORT, 1LINE NORMAL, 1LINE LONG, 2LINE SHORT, 2LINE NORMAL	p.78
	MODE	-	NONE, MODEL, EDGE	p.79
	MODEL	-	-	p.79
	COLOR	BLACK	BLACK, WHITE	p.80
	DIRECTION	→	↑, ↓, →, ←	p.80
	SEARCH AREA	-	-	p.81
	STABLE	OFF	OFF, ON	p.81
SYS2 EXP MENU OUTPUT	ON STATUS	NG ON	OK ON, NG ON	p.65
	ONE SHOT	OFF	OFF, ON	p.66
	ON DELAY	0	0 to 255	p.66
	OFF DELAY	0	0 to 255	p.67
	OUTPUT TIME	0	0 to 255	p.66
TEACH IMAGE	THROUGH	-	-	p.63
	FREEZE	-	-	p.63
	I/O MON	-	-	p.68
COM	MODE	COMPOWAY	COMPOWAY,NORMAL	p.64
	DELMIT	CR	CR, LF, CR+LF	p.64
	ALL CLEAR	-	-	p.62
	MEAS CLEAR	-	-	p.62
	VERSION	-	-	p.63
LINKSET(*3)	TRIG	I/O	I/O, LINK	p.69
	HEAD	USE	USE, NOT USE	p.70
	OUTPUT	EACH	ALL, EACH	p.70

(*3)This menu is displayed only when Amplifier Units are gang-mounted.



Executing Teaching

Execute teaching, and set the measurement conditions. Project the image to be used as the accepted image as the details set in teaching are used as the reference in judgment.

Teaching Flow

There are two ways of executing teaching, by key operation and by external signals. The following shows a procedure for teaching by key operation

 For external input teaching p.35

1. Switch to MENU mode.
2. Put the cursor on [TEACH] then press the SET key.
3. Adjust the position to display workpiece to the monitor while checking the image.
 For still image teaching p.63
4. Put the cursor on [1.ITEM] then press the SET key.
5. Select teaching type.
 Types of Teaching p.51

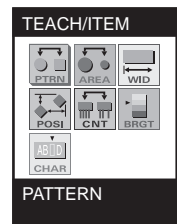
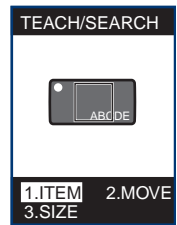
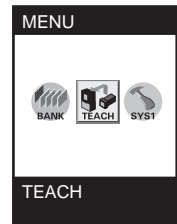
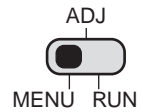

6. Press the TEACH key to perform teaching.

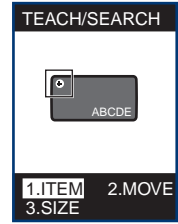

When changing the teaching area positioning or size, select [MOVE] or [SIZE] from screen 3 then adjust accordingly.

[MOVE]

Move the area to the position for teaching then press the SET key.

[SIZE]

Adjust the area size for teaching then press the SET key.

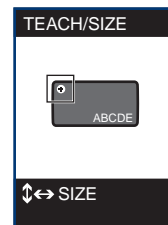
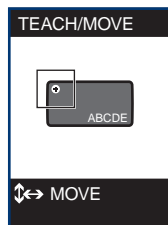

Teaching cannot be performed from the MOVE screen or SIZE screen. Set changes with the SET key then return to screen 6 and perform teaching.

7. Switch to ADJ mode.

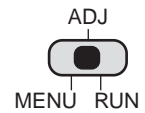

8. Measurement starts.

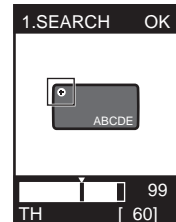

Teaching Key Operations and Screen Transition

FUN mode top screen



● Teaching execution

TEACH/VIEW

● Setting of teaching conditions

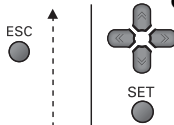

ITEM

MOVE

SIZE

Setting the teaching details

Moving the position of the teaching area

Changing the size of the teaching area

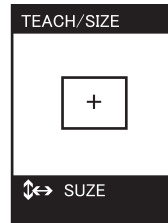
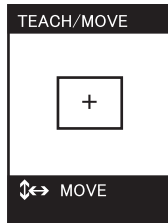
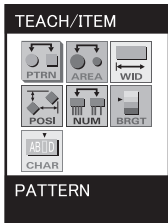

Types of Teaching



Select the type of teaching according to the detection content.







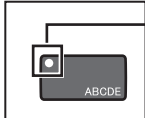
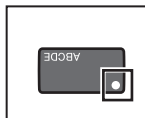
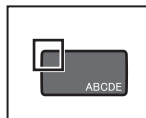
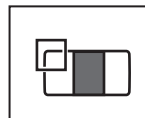

The details that are displayed differ according to the model of Amplifier Unit that you are using.

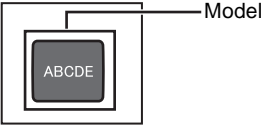

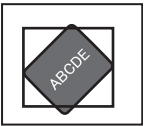

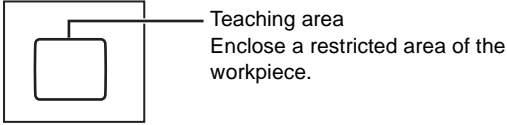
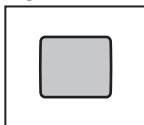
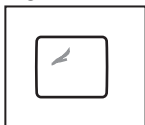

Detection Content	Type of Teaching to Select	Pages
Pattern/shape/presence	PATTERN/SEARCH, MATCH	p.51, p.52
Brightness/scratches, dirt	BRIGHT	p.52
Size/area	AREA*	p.52
Width	WIDTH*	p.53
Position	POSITION*	p.53
Number	COUNT*	p.53
Characters	CHARA/CHARA 1, CHARA 2*	p.54

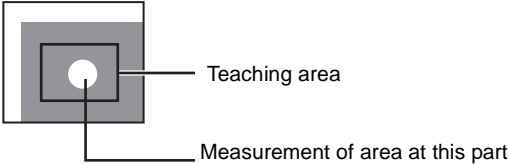

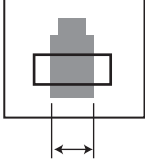
* : These items are displayed only when standard type Amplifier Unit is in use.

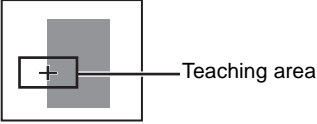
► MENU mode-[ITEM]

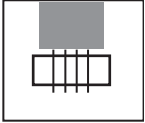
Item		Description	Example of Application
PATTERN 	SEARCH	<p>Select this item to detect the presence of a workpiece. This item supports workpieces tilted to an angle of $\pm 45^\circ$. Teach the image pattern to be recognized, and register this pattern as a model. Judgment is performed by whether the registered model "is" or "is not" in the detected image.</p> <p>Example) To recognize by the presence of a mark</p> <p>Non-defective item</p>  <p>Model</p>  <p>OK</p>  <p>NG</p>  <p>NG</p> <p> Measurement is unstable when there are two or more of the same pattern. Register unique patterns in the screen or restrict the search range.</p> <p>CHECK!</p> <p> Changing the search area p.81</p>	<p>Detection of presence of sales campaign seals</p> <p>Recognition of top/rear side and orientation of electronic components</p>

Item	Description	Example of Application
<p>PATTERN MATCH</p> 	<p>Select this item for detecting shapes and recognizing different objects. Judgment is performed by comparing the degree of match between a registered model and the target workpiece. Compared with [SEARCH], more detailed detection is possible, and larger workpieces can be detected. Note, however, that this item does not support tilted workpieces.</p> <p>Non-defective item</p>  <p>NG</p>  <p>NG</p>  <p> Measurement is unstable when there are two or more of the same pattern. Register unique patterns in the screen or restrict the search range. CHECK!</p> <p> Changing the search area p.81</p>	<p>Recognition of different kind of instruction sheet</p>
<p>BRIGHT</p> 	<p>Select this item to detect brightness (density) or scratches/dirt on plain workpieces. Set the teaching area to the desired part of the workpiece to detect brightness in, and execute teaching.</p> <p>Non-defective item</p>  <p>NG</p>  <p>NG</p> 	<p>Detection of scratches/dirt in sheets Checking of lighting of indicators</p>
<p>AREA*</p> 	<p>Select this item to recognize objects by size (area). Set the teaching area to the desired part of the workpiece to detect the size (area) in, and execute teaching.</p> 	<p>Detection of presence of screw threads Inspection of shortages in confectionary Detection of presence of silver paste</p>

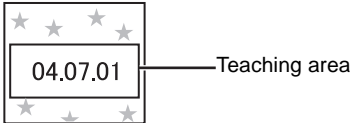
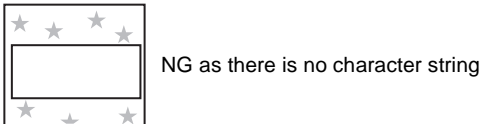
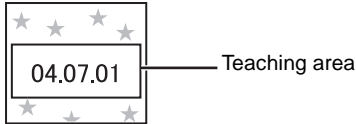
Item	Description	Example of Application
<p>WIDTH *</p> 	<p>Select this item to detect width or interval. Set the teaching area to the part of the workpiece to perform measurement in, and execute teaching.</p> <p>Example) To measure width</p>  <p> Set so that there are two changes in brightness in the detection area such as "light to dark" or "dark to light." CHECK!</p>	<p>Detection of lead width on capacitors or other electronic components Detection of bent leads Detection of out-of-position labels</p>
<p>POSITION*</p> 	<p>Select this item to detect the position of a workpiece. Set the teaching area to the part of the workpiece to perform measurement in, and execute teaching. The edge of the workpiece is detected, and judgment is performed by comparing those edge coordinates against reference coordinates.</p> <p>Example)</p>  <p> Set so that there is one change in brightness in the detection area such as "light to dark" or "dark to light." CHECK!</p>	<p>Detection of out-of-position labels</p>
<p>COUNT*</p> 	<p>Select this item when counting the number of workpieces. Set the teaching area to the part of the workpiece to perform detection in, and execute teaching. The edges in the teaching area are detected, and judgment is performed by comparing the number of edges with a reference value.</p> <p>Example) To detect the number of leads</p>  <p> A change in brightness such as "light to dark to light" or "dark to light to dark" is counted as "1". In the above example, the count is "4". CHECK!</p>	<p>Detection of the number of leads Count of the number of cables</p>

Item	Description	Example of Application
CHARA* 	CHARA 1 Select this item to detect the presence of an entire character string printed on a plain background. Judgment is performed by comparing the changes in density (brightness) of a registered character string. Omission of characters, errors, missing dots, etc. cannot be detected.  Example) 	Detection of presence of entire character string such as the "Best-before" date
CHARA 2	Select this item to detect omission of single characters. Errors in characters, missing dots, etc. cannot be detected.  Example) 	

* : This is displayed only when a standard type Amplifier Unit is in use.



About the teaching area for [CHARA]

For the teaching area when the printing position is out of position, set to an area in which the character string might possibly be printed out of position. (Be sure, however, to set to an area having a plain background.)

If an area very close to the character string without any margin is set, the sensor will not be able to track any shift in the printing position.



Any shift of the printing position inside the teaching area is judged as OK.



When the teaching area is set very close to the character without any margin, character protrudes from the teaching area and so this is judged as an NG.

Adjusting Threshold Values

Threshold values are adjusted to determine the range for OK judgments. Adjust the threshold values referring to the currently indicated measurement results. The adjustment details differ according to the currently set teaching mode.

SEARCH, MATCH

- Switch to ADJ Mode.
- Adjustment of correlation value

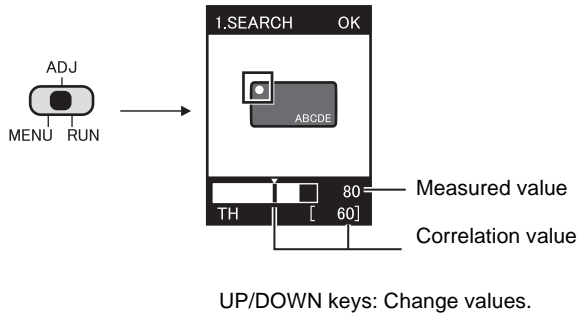

Setting item	Range	Details of Adjustment
Correlation value	0 to 100	This is the lower limit of the correlation value with the teaching model This value or above is judged as OK.

BRIGHT

- Switch to ADJ Mode.
- Adjustment of average density value
- Adjustment of density deviation value

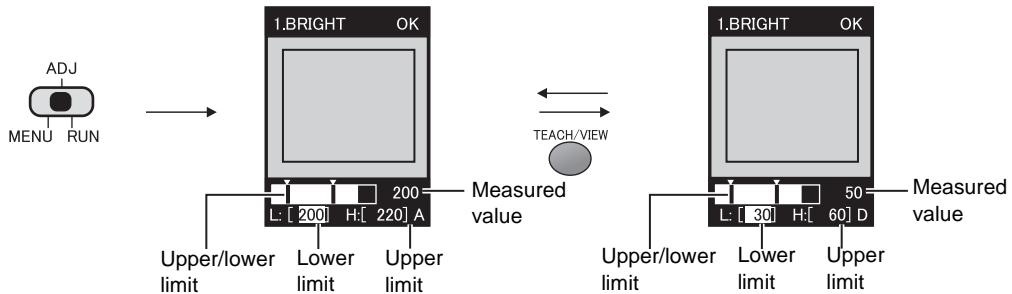

LEFT/RIGHT keys: Select upper limit/lower limit. UP/DOWN keys: Change values.

LEFT/RIGHT keys: Select upper limit/lower limit. UP/DOWN keys: Change values.

Setting item	Range	Details of Adjustment
Average density value	0 to 255	This is the range of the average density inside the teaching area.
Density deviation value	0 to 127	This is the range of the density deviation inside the teaching area.

■ AREA

- Switch to ADJ Mode.
- Adjustment of area value

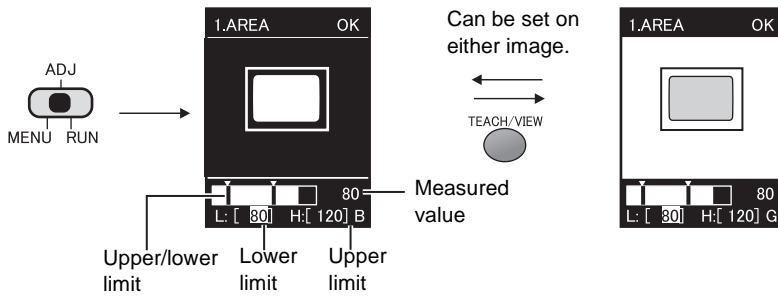

LEFT/RIGHT keys: Select upper limit/lower limit.
UP/DOWN keys: Change values.

Setting item	Range	Details of Adjustment
Area value	0 to 999	This is the area in which OK is judged when the area value during teaching is taken to be 100%.

■ WIDTH

- Switch to ADJ Mode.
- Adjustment of edge width
- Adjustment of edge level

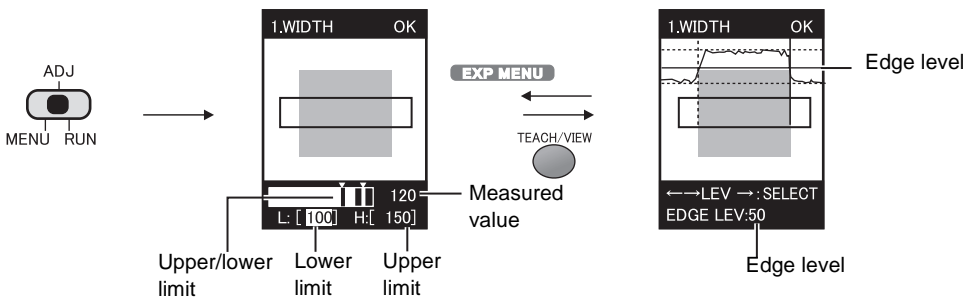

LEFT/RIGHT keys: Select upper limit/lower limit.
UP/DOWN keys: Change values.

- When edge detection direction is \longleftrightarrow
LEFT/RIGHT keys: Switch edge.
UP/DOWN keys: Change values.
- When edge detection direction is $\uparrow \downarrow$
UP/DOWN keys: Switch edge.
LEFT/RIGHT keys: Change values.

Setting item	Range	Details of Adjustment
Edge width	0 to 999	This is the area in which OK is judged when the width during teaching is taken to be 100%.
Edge level	0 to 100	This is the level of change in density judged to be an edge. Adjust this level when measurement is unstable. <div style="text-align: center;"> </div>

POSITION

- Switch to ADJ Mode.
- Adjustment of edge position
- Adjustment of edge level

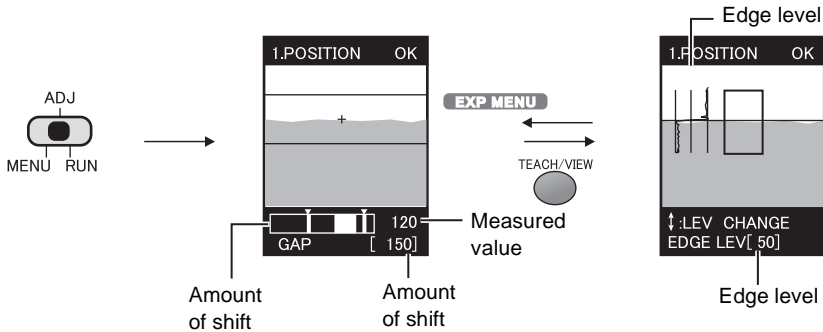

UP/DOWN keys: Change values.

- When edge detection direction is → UP/DOWN keys: Change values.
- When edge detection direction is ↓ LEFT/RIGHT keys: Change values.

Setting item	Range	Details of Adjustment
Position	0 to 468	Amount of shift from reference position
Edge level	0 to 100	This is the level of change in density judged to be an edge. Adjust this level when measurement is unstable. p.56

COUNT

- Switch to ADJ Mode.
- Adjustment of number
- Adjustment of edge level

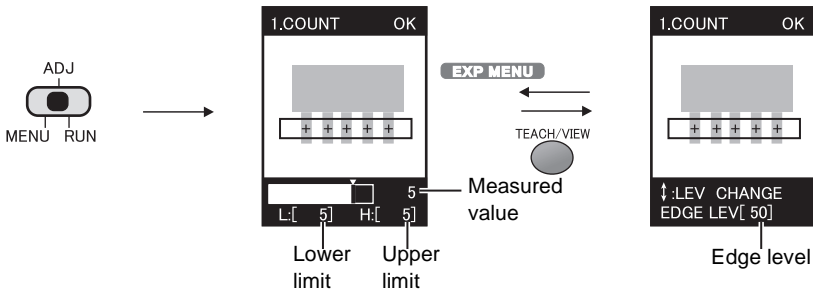

UP/DOWN keys: Change values.

Setting item	Range	Details of Adjustment
Number	0 to 255	This is the number of times that counting is to be performed.
Edge level	0 to 100	This is the level of change in density judged to be an edge. Adjust this level when measurement is unstable. p.56

■ CHARA 1

- Switch to ADJ Mode.
- Adjustment of correlation value

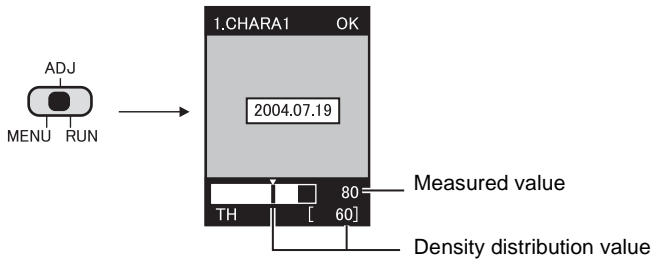

UP/DOWN keys: Change values.

Setting item	Range	Details of Adjustment
Density distribution value	0 to 100	This is the value that is judged as OK when the density deviation value during teaching is taken to be 100%.

■ CHARA 2

- Switch to ADJ Mode.
- Adjustment of correlation value

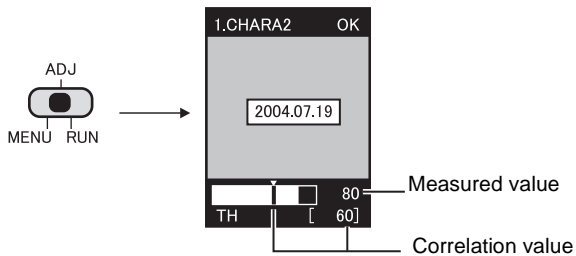

UP/DOWN keys: Change values.

Setting item	Range	Details of Adjustment
Correlation value	0 to 100	This is the lower limit of the correlation value with the teaching model. This value or above is judged as OK.

Performing Measurement

When the mode is switched to the RUN mode, measurement is executed, and the measurement result is output to the external device.

Switching the display during measurement

The display details are switched by pressing the TEACH/VIEW key during measurement.



CHECK!

The measurement time differs according to the type of display image. The measurement time for "only image display" is the fastest. The number in parentheses () serves as a guideline when "only image display" is taken as the reference.

When the image is switched during measurement, the measurement time changes. For this reason, monitor the ENABLE signal, wait for the ENABLE signal to turn ON, and then input the TRIG signal.

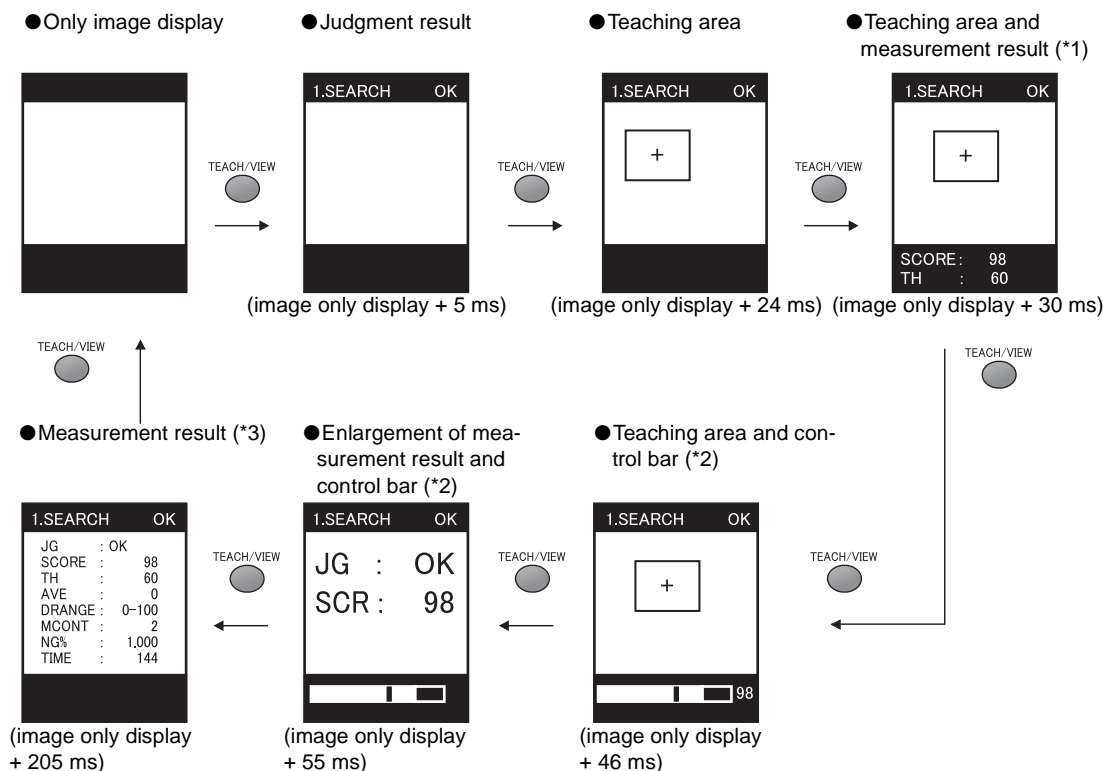

(*1): In the case of [BRIGHT], the display can be switched (average density value, density distribution value) by the LEFT/RIGHT keys.

In the case of [AREA], the display can be switched to binary image by the LEFT/RIGHT keys.

(*2): The control bar shows the measurement result and judgment threshold value.

(*3): The measurement time (TIME) indicated here is the shortest measurement time in "only image display."



CHECK!

About meaning of display details in measurement results
p.87

Setting Banks

The ZFV Series can hold up to eight sets of settings. These settings can be switched externally when changing the device setup.

A set of these settings is called a “bank.”

Switching banks

BANK 1 is selected as the default. BANK 2 and 8 are also available.



BANKs can also be switched from an external device.



Bank switching p.36

▶ MENU mode-[BANK]

Setting	Description
BANK 1 to BANK 8 (default value: BANK 1)	Selects the target bank.

Copying banks

Copy the settings of other bank numbers to an already selected bank number.

▶ MENU Mode-[SYS1]-[BANKSET]-[COPY]

Clearing banks

“Clearing” deletes the settings of the currently selected bank number.

▶ MENU Mode-[SYS1]-[BANKSET]-[CLEAR]



[SYS1], [SYS2] settings and RUN Mode display settings cannot be cleared.

Setting the bank switching method

Select how to switch banks.

▶ MENU Mode-[SYS1]-[BANKSET]-[SWITCH]

Setting	Description
KEY (default value)	Banks are switched by the control keys on Amplifier Unit.
I/O	Banks are switched by the control keys on Amplifier Unit and by external signals. Switching by external signals is enabled only in the RUN mode.

Setting the System Environment

Adjusting the measurement speed

Set the resolution of the input image.

Change the resolution according to the required precision and speed of measurement.

► MENU Mode-[SYS1]-[IMAGE RATE]

Setting	Description
FINE	Select this when performing measurement by a high-precision image. Note, however, that it takes longer to perform measurements.
NORMAL (default value)	Standard
HIGH SPEED	Select this to perform high-speed measurement. Note, however, that images are rougher.

Selecting the measurement timing

Set the timing that measurement is executed.

► MENU Mode-[SYS1]-[MEAS TYPE]

Setting	Description
TRIG (default value)	Synchronous measurement Measurement is performed in synchronous with the change in state of the external TRIG signal from OFF to ON.
CONTINUE	Continuous measurement Measurement is repeatedly performed for the duration that the TRIG signal is ON.

Selecting the teaching mode from an external device

There are two teaching modes from an external device.

► MENU Mode-[SYS1]-[TEACH TYPE]

Setting	Description
STATIONARY (default)	Teaching is performed with the workpiece in a stationary state. Input of the external trigger input is required for teaching.
MOVING	The teaching is performed with the moving workpiece. Select this teaching mode only when the workpiece cannot be stopped. Input of the external trigger is required for teaching.

 Timing charts p.34

Setting/canceling the “Eco” mode

Whether or not to darken the screen when a preset time has passed without any operation. We recommend setting this mode to [ON] to prevent the brightness of the LCD screen from being impaired.

▶ MENU Mode-[SYS1]-[ECO MODE]

Setting	Description
ON (default value)	Sets the “Eco” mode. The screen darkens when three minutes continue without any operation.
OFF	Cancels the “Eco” mode setting.

Initializing setup data

EXP MENU

Return all bank settings and system settings to their factory settings.



CHECK!

The settings of all banks and system settings are initialized regardless of the currently selected bank No.

▶ MENU Mode-[SYS2]-[ALL CLEAR]

Setting	Description
EXECUTE	Initializes the setup data.
CANCEL	Does not initialize the setup data.

Initializing measurement data

EXP MENU

Current and past measurement average values, measurement count and other measurement data can be cleared without restarting.

Data to be cleared are the items displayed in the following screen at RUN mode.

1.SEARCH		OK
JG	:	OK
SCORE	:	98
TH	:	60
AVE	:	0
DRANGE	:	0-100
MCONT	:	2
NG%	:	1.000
TIME	:	144



Meaning of display contents p.87

▶ MENU Mode-[SYS2]-[MEAS CLEAR]

Setting	Description
EXECUTE	Initialize measurement data.
CANCEL	Do not initialize measurement data.

Checking the version

EXP MENU

Displays the type of Sensor Head, type of Amplifier Unit and system version information of the software.



► MENU Mode-[SYS2]-[VERSION]

Changing image capture timing on teaching screen

EXP MENU

Select status of image to be displayed in the teaching screen.

► MENU Mode-[SYS2]-[TEACH IMAGE]

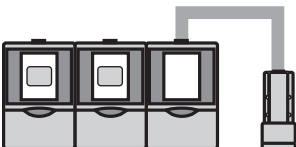
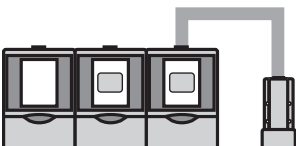
Setting	Description
THROUGH (default value)	Display the latest raw image being inputted from the sensor head.
FREEZE	<p>Freeze the image and display. The still image is displayed when the TRIG signal is input from the teaching screen.</p> <p> When amplifier units are gang-mounted, set all amplifier units to the teaching screen then input the TRIG signal to the amplifier unit (furthest to the right) where the sensor head is connected.</p> <p>CHECK!</p> <div style="display: flex; align-items: flex-start;"> <div style="margin-right: 10px; text-align: center;">○</div> <div style="text-align: center;">  <p>TRIG signal</p> </div> <div style="margin-left: 10px;"> <p>Images are loaded to all amplifier units when all amplifier units are set to the teaching screen.</p> </div> </div> <div style="display: flex; align-items: flex-start; margin-top: 10px;"> <div style="margin-right: 10px; text-align: center;">×</div> <div style="text-align: center;">  <p>TRIG signal</p> </div> <div style="margin-left: 10px;"> <p>Images are not loaded to all amplifier units when the amplifier where the sensor head is connected is not set to the teaching screen.</p> </div> </div> <div style="display: flex; align-items: flex-start; margin-top: 10px;"> <div style="margin-right: 10px; text-align: center;">×</div> <div style="text-align: center;">  <p>TRIG signal</p> </div> <div style="margin-left: 10px;"> <p>Images are not loaded to the far left amplifier when the far left amplifier is not at the teaching screen.</p> </div> </div>

Setting communications environment

EXP MENU

► MENU Mode-[SYS2]-[COM]

[MODE]

CompoWay/F or no procedures can be set to the communications protocol.

Setting	Description
COMPOWAY (default value)	Use this when gang-mounted only with ZFV. This allows communications with external devices using the OMRON proprietary communication protocol CompoWay/F.
NORMAL	Select when connected to the ZS-DSU for communication without external device procedures.



For details on command formats, refer to the ZS-DSU manual, "Communication Command Reference" (provided separately).



Set the same communications protocol when gang-mounted with ZS-DSU.

CHECK!

[DELMIT]

A delimiter can be set when there are no communication protocol procedures.

Setting
CR (default value)
LF
CR+LF

Changing the Input/output Conditions

Selecting the ON conditions

EXP MENU

Set whether to turn the OUTPUT signal ON when OK is judged or when NG is judged.

▶ MENU Mode-[SYS2]-[OUTPUT]-[ON STATUS]

Setting	Description
OK ON	Turns the OUTPUT signal ON when OK is judged.
NG ON (default value)	Turns the OUTPUT signal ON when NG is judged.

One-shot output

EXP MENU

OUTPUT turns ON for only the preset output time from when the OUTPUT signal turns ON.

● Synchronous measurement

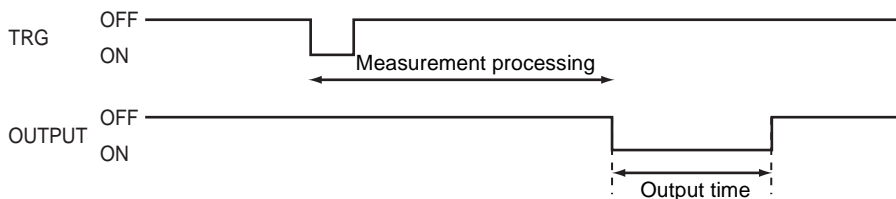

● Continuous measurement

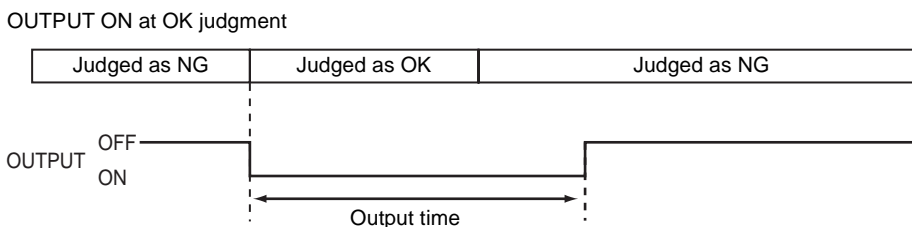

■ Selecting one-shot output ON/OFF

Set whether or not to enable one-shot output on the OUTPUT signal.

▶ MENU Mode-[SYS2]-[OUTPUT]-[ONE SHOT]

Setting	Description
OFF (default value)	One-shot output is not performed.
ON	One-shot output is performed.



CHECK!

When one-shot output is set to [ON], the OFF delay time setting is disabled.

■ Setting the one-shot output time

EXP MENU

OUTPUT turns ON for the preset time from when the OUTPUT signal turns ON. This setting is valid only when [ONE SHOT] is set to [ON].

▶ MENU Mode-[SYS2]-[OUTPUT]-[OUTPUT TIME]

Setting	Description
0 to 255 (default value:0)	Set the time (ms) that OUTPUT is turned ON.

Setting the ON delay time

EXP MENU

Set this item to delay the timing that the OUTPUT signal turns ON.

OUTPUT ON at OK judgment in continuous measurement

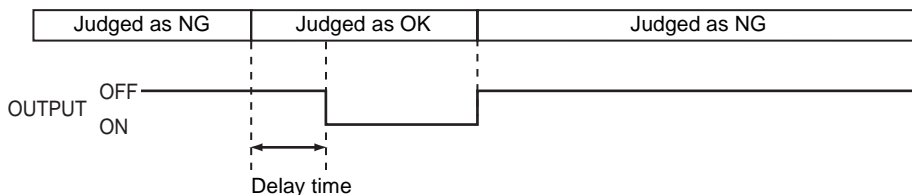

▶ MENU Mode-[SYS2]-[OUTPUT]-[ON DELAY]

Setting	Description
0 to 255 (default value:0)	Set the time (ms) to delay turning ON of the OUTPUT signal.

Setting the OFF delay time

EXP MENU

Set this item to delay the timing that the OUTPUT signal turns OFF.

OUTPUT ON at OK judgment in continuous measurement

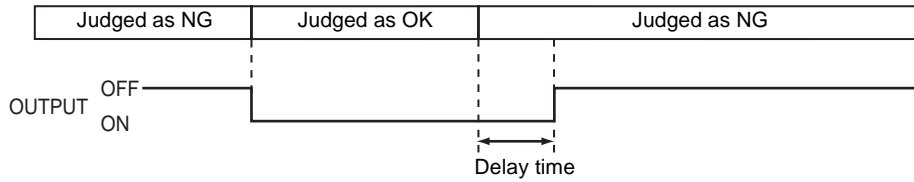

► MENU Mode-[SYS2]-[OUTPUT]-[OFF DELAY]

Setting	Description
0 to 255 (default value:0)	Set the time (ms) to delay turning OFF of the OUTPUT signal.

I/O Monitor Function

EXP MENU

This is a function to check the status of I/O signals.

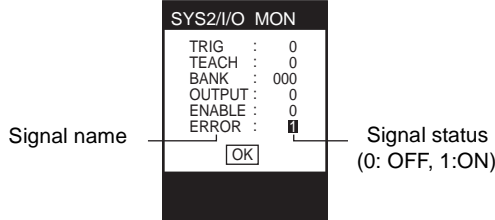

► MENU Mode-[SYS2]-[I/O MON]

Setting	Description
TRIG	Displays ON/OFF status of TRIG signal. (0:OFF, 1:ON)
TEACH	Displays ON/OFF status of TEACH signal. (0:OFF, 1:ON)
BANK	Displays ON/OFF status of BANK signal. (0:OFF, 1:ON) Expresses BANK1, BANK2, BANK3 sequentially from the right.
OUTPUT	Displays ON/OFF status of OUTPUT signal. (0:OFF, 1:ON)
ENABLE	Displays ON/OFF status of ENABLE signal. (0:OFF, 1:ON)
ERROR	Displays ON/OFF status of ERROR signal. (0:OFF, 1:ON)



Put the cursor on BANK, OUTPUT, ENABLE then press the SET button key to switch between "0" and "1". The external device operations can be checked by switching output OFF/ON when the actual measurements are not being performed.

Settings During Application Extended Connection

These menus are displayed only when Amplifier Units are gang-mounted.
Set to the all gang-mounted Amplifier Units.

Example 1)

AMP2: TRIG signal input, AMP2: Output of overall judgment result

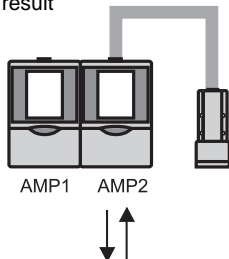

MENU	AMP1	AMP2
TRIG	LINK	I/O
HEAD	NOTUSE	USE
OUTPUT	—	All

Example 2)

AMP2: TRIG signal input, AMP2: Output of overall judgment result

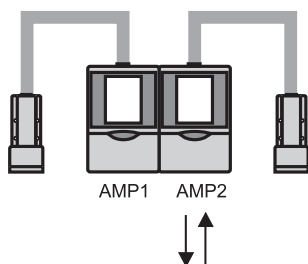

MENU	AMP1	AMP2
TRIG	LINK	I/O
HEAD	USE	USE
OUTPUT	—	All

Specifying the Amplifier Unit to input the trigger

EXP MENU

Set whether or not to input the TRIG signal to an Amplifier Unit.

► MENU Mode-[SYS2]-[LINKSET]-[TRIG]

Setting	Description
I/O (default value)	Set to only the Amplifier Unit to which the TRIG signal is to be input.
LINK	Synchronizes to the TRIG signal from the Amplifier Unit gang-mounted on the right side.

Setting the presence of Sensor Head

EXP MENU

Set whether or not a Sensor Head is connected.

▶ MENU Mode-[SYS2]-[LINKSET]-[HEAD]

Setting	Description
USE (default value)	Select this for Amplifier Unit to which a Sensor Head is currently connected. Measurement is performed using the input image from the currently connected Sensor Head.
NOT USE	Select this for Amplifier Unit to which a Sensor Head is currently not connected. Measurement is performed from the image transferred from the Sensor Head gang-mounted on the right side.

Setting output content

EXP MENU

Set the output content of the measurement result.

This item is displayed only the Amplifier Unit whose [TRIG/TRIG] setting is set to [I/O].

▶ MENU Mode-[SYS2]-[LINKSET]-[OUTPUT]

Setting	Description
ALL	The measurement results of all gang-mounted Amplifier Units are integrated, and output as an overall judgment result.
EACH (default value)	The measurement result of each Amplifier Unit is output from the respective Amplifier Unit.

 Output image p.93

Customizing Measurement conditions

EXP MENU

The display items from [CUSTM] onwards differ according to the teaching type set at [ITEM].

Common items

■ Adjusting light emission

Adjust the intensity of the light emitted from Sensor Head.

The light intensity of each adjusted section is displayed as a 4-digit number.

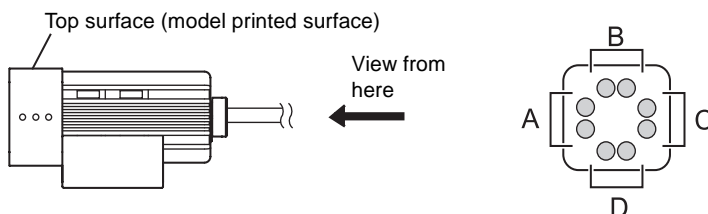

An image of how light is emitted is displayed on screen.

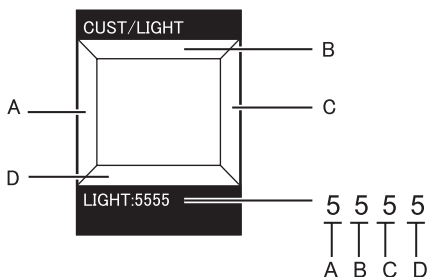

The light intensity can also be adjusted partially (A to D).

Adjust the light intensity by the UP/DOWN keys.

Setting	Description
0 to 5 (default value: 5)	0: Out, 1 to 5: Light intensity increases the larger the number.

► MENU Mode-[CUSTM]-[LIGHT]

1. Switch the light intensity by the UP/DOWN keys.

When performing partial adjustment

- LEFT/RIGHT keys: Select the adjustment section.
- UP/DOWN keys: Select the light intensity.

2. Press the SET Key to apply the setting.

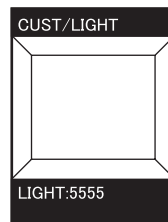

PATTERN/SEARCH, MATCH

■ Changing the search area

Change the area to search the model in.
Specify the top left and bottom right of the search area.

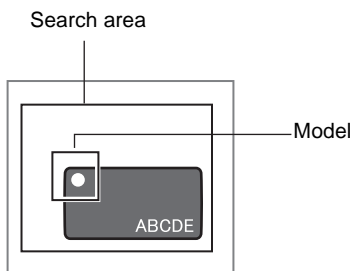

▶ MENU Mode-[CUSTM]-[SEARCH AREA]

■ Setting the rotation range of a workpiece

This item is displayed only when [SEARCH] is set.
Set this item when even a tilted workpiece is to be set as a non-defective item.

▶ MENU Mode-[CUSTM]-[ROTATION]

Setting	Description
±10° (default value)	Set the range of acceptable tilt
±20°	
±30°	
±45°	



The larger the range of acceptable tilt, the longer it takes to perform measurement.

CHECK!

BRIGHT

■ Changing the detection content

Select the content whose brightness is to be detected.

▶ MENU Mode-[CUSTM]-[METHOD]

Setting	Description
AVERAGE (default value)	Performs detection using brightness (average density value). Whether or not an object is lighter or darker is detected by referring to the density during teaching.
DEVIATION	Performs detection using sudden changes (density deviation) in density. Select this to detect the presence of scratches or dirt.

Teaching image

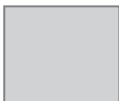

When [AVERAGE] is set

OK



NG



NG



NG judged when density is different

When [DEVIATION] is set

OK

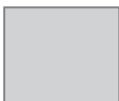

OK judged if there is no density change even if density is different

OK



NG



NG judged if there is density change

NG



AREA

■ Reversing black-and-white images

Reverse the currently displayed binary image.

As white pixels are targeted for measurement, select which part of the measured area is to be set to white pixels.

▶ MENU Mode-[CUSTM]-[COLOR]

Setting	Description
WHITE (default value)	Select which part of the measurement area is to be set as white pixels.
BLACK	

■ Changing the binarization level

Set the level for converting 256-tone contrast image captured from Sensor Head to a binary image.

▶ MENU Mode-[CUSTM]-[BINARY]

Setting	Description
0 to 255	As white pixels are targeted for measurement, adjust the binarization level so that the measurement area is converted to white pixels.

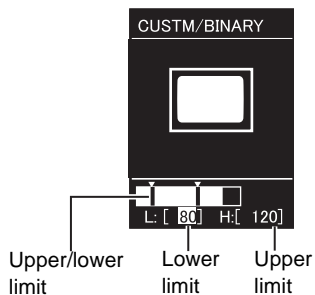

LEFT/RIGHT keys: Select upper limit/lower limit.

UP/DOWN keys: Change values.

WIDTH

■ Specifying edge detection conditions

Set the direction in which edges are searched and the change in density.

Example)

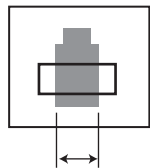

To detect this width

Teaching area

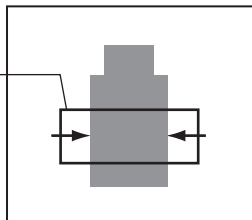

COLOR : BLACK
DIRECTION : ← →

● Selecting the color of edges

Select the direction of density change for the edge to be detected.

▶ MENU Mode-[CUSTM]-[COLOR]

Setting	Description
WHITE (default value)	A change from dark to light is judged as an edge.
BLACK	A change from light to dark is judged as an edge.

● Selecting the edge detection direction

Select the direction in which edges are searched.

▶ MENU Mode-[CUSTM]-[DIRECTION]

Setting	Description
↑ ↓	Searches in the vertical direction.
← →(default value)	Searches in the horizontal direction.

POSITION

■ Specifying edge detection conditions

Set the direction in which edges are searched and the change in density.

Example)

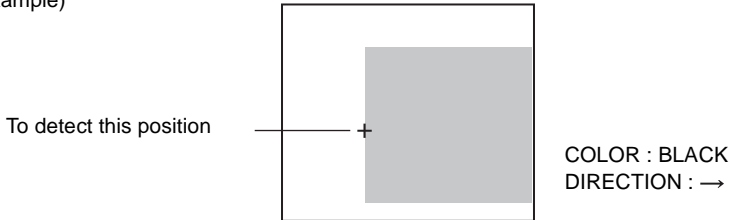

● Selecting the color of edges

Select the direction of density change for the edge to be detected.

▶ MENU Mode-[CUSTM]-[COLOR]

Setting	Description
WHITE (default value)	A change from dark to light is judged as an edge.
BLACK	A change from light to dark is judged as an edge

● Selecting the edge detection direction

Select the direction in which edges are searched.

▶ MENU Mode-[CUSTM]-[DIRECTION]

Setting	Description
↑	Searches from bottom to top.
↓	Searches from top to bottom.
→(default value)	Searches from left to right.
←	Searches from right to left.

● Changing edge detectivity

Change detectivity when a stable edge cannot be located.

▶ MENU Mode-[CUSTM]-[EDGE SENSE]

Setting	Description
SENSITIVE	Edge detectivity becomes sensitive. Select this when there is little background density deviation and a stable edge cannot be located.
NORMAL (default value)	Standard detectivity.
ROUGH	Edge detectivity becomes insensitive. Select this when debris is mistakenly detected as the edge.

COUNT

■ Specifying edge detection conditions

Set the direction in which edges are searched and the change in density.

Example)

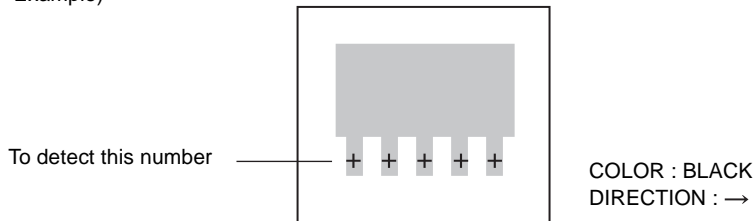

● Selecting the color of edges

Select the direction of density change for the edge to be detected.

▶ MENU Mode-[CUSTM]-[COLOR]

Setting	Description
WHITE (default value)	A change from dark to light is judged as an edge.
BLACK	A change from light to dark is judged as an edge

● Selecting the edge detection

Select the direction in which edges are searched.

▶ MENU Mode-[CUSTM]-[DIRECTION]

Setting	Description
↓	Searches from top to bottom.
→ (default value)	Searches from left to right.

CHARA/CHARA 1, CHARA 2

■ Set the model registration conditions for characters

This item is displayed only when [CHARA 2] is set.

Select the number of characters in the preset teaching area.

Select the number of characters being within a certain number of characters on one or two lines.

Selection guidelines

- 8 characters, 1 line

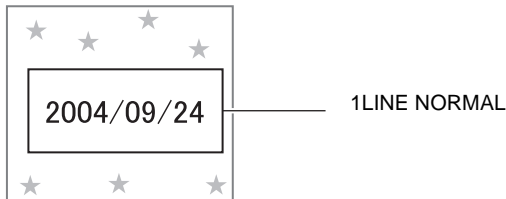

- 8 characters, 2 line

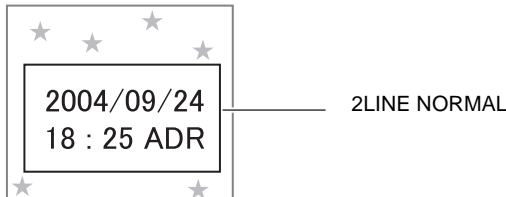

▶ MENU Mode-[CUSTM]-[MDL DIV]

Setting	Description
1LINE SHORT	Select this when the character string is 6 characters or less on 1 line.
1LINE NORMAL (default value)	Select this when the character string is 8 characters or less on 1 line.
1LINE LONG	Select this when the character string is 15 characters or less on 1 line
2LINE SHORT	Select this when the character string is 6 characters or less on 2 lines.
2LINE NORMAL	Select this when the character string is 8 characters or less on 2 lines.



The number of characters in the above table are for reference only. When there are more characters than the number of reference characters in the selected item, measurement accuracy drops.

■ Select whether or not to perform Position compensation

Set Position compensation for improving detection accuracy in the following instances:

When there is a pattern in the detection range



When printed text is out of position

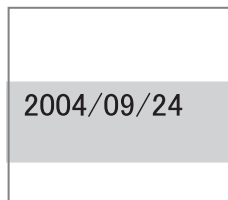

► MENU Mode-[CUSTM]-[MODE]

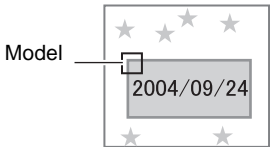
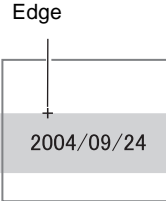
Setting	Description
NONE	The position is not corrected.
MODEL	The model is used to correct the position. Select this when there is a characteristics part such as a corner of a text box. 
EDGE	The edge position is used to correct the position. 

■ Select the content of position compensation

● Registering models

Set this when [MODEL] is selected to [MODE]

Specify the top left coordinate and bottom left coordinate of the model.

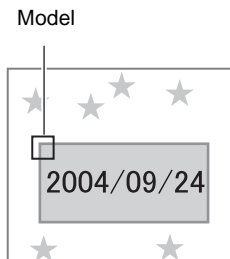

► MENU Mode-[CUSTM]-[MODE DTL]-[MODEL]

● **Specifying edge detection conditions**

Set this when [EDGE] is selected to [MODE].

Set the direction in which edges are searched and the change in density.

Example)

To correction position by this edge

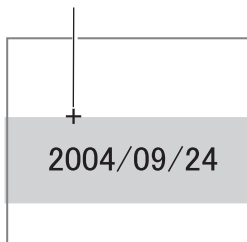

COLOR: BLACK
 EDGE: ↓

- **Selecting the color of edges**
 Select the direction of density change for the edge to be detected.

▶ MENU Mode-[CUSTM]-[MODE DTL]-[COLOR]

Setting	Description
WHITE	A change from dark to light is judged as an edge.
BLACK (default value)	A change from light to dark is judged as an edge.

- **Selecting the edge detection direction**
 Select the direction in which edges are searched.

▶ MENU Mode-[CUSTM]-[MODE DTL]-[DIRECTION]

Setting	Description
↑ (default value)	Searches from bottom to top.
↓	Searches from top to bottom.
→	Searches from left to right.
←	Searches from right to left.

■ Changing the search area

Change the area to search edges or the model in.

Specify the top left coordinate and bottom left coordinate of the area.

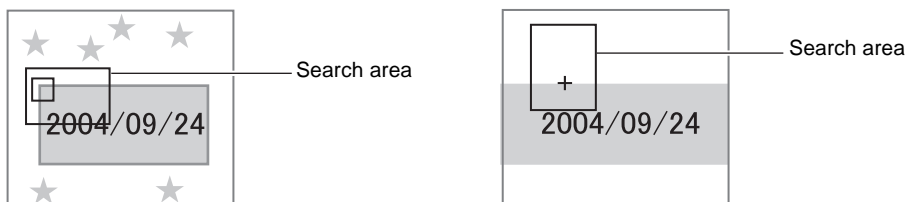

► MENU Mode-[CUSTM]-[MODE DTL]-[SEARCH AREA]



When searching edges

Measurement can be performed only when the search area contains an edge.

Determine the size and position of the area taking the movement range of the workpiece into consideration.

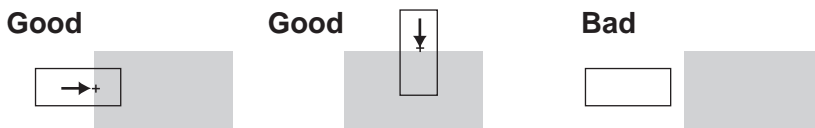

■ Raising detection stability

This item is displayed only when [CHARA2] is set.

► MENU Mode-[CUSTM]-[STABLE]

Setting	Description
OFF (default value)	Standard detection method.
ON	Detailed detection method. The process time is longer than OFF.

Saving the Set Measurement Conditions

The set measurement conditions are saved to the amplifier unit when it is switched to RUN mode.

Saving is done automatically, and no confirmation message is displayed.

If the power is turned off without saving, the changed contents, including the teaching results, will be cleared from memory.



CHECK!

When external TEACH signal teaching is successful in RUN mode, the set measurement conditions are automatically saved.

When the TEACH key is pressed from the teaching screen to teach, the contents will not be saved unless the amplifier unit is switched to RUN mode once.

Section 4

APPENDIX

☒ Troubleshooting	84
☒ Error Messages and Remedies	85
☒ Q&A	86
☒ Run Mode Display Item List	87
☒ When Gang-mounting Amplifier Units	89
☒ Specifications and External Dimensions	95
☒ Version Up Information	103
☒ INDEX	105

Troubleshooting

This section describes countermeasures for temporary hardware problems. Check the malfunction in this section before sending the hardware for repair.

Problem	Probable cause and possible countermeasure	Pages
OUTPUT indicator does not lit.	<ul style="list-style-type: none"> Check the setting of [SYS2]-[OUTPUT]-[ON STATUS]. To lit the indicator (OUTPUT signal ON) when the judgment is OK, select [OK ON], and to lit the indicator (OUTPUT signal ON) when the judgment is NG, select [NG ON]. 	p.65
RUN indicator does not lit.	<ul style="list-style-type: none"> Is the operating mode switch set to "RUN"? 	p.44
Dark LCD screen	<ul style="list-style-type: none"> Is the "Eco" mode function set? The "Eco" mode is set if pressing any key automatically returns to the original brightness. The brightness is maintained when the "Eco" mode setting is canceled. Note, however, that the life of the LCD backlight is shortened. So, we recommend setting the "Eco" mode. 	p.62
Images are not displayed.	<ul style="list-style-type: none"> Is the Sensor Head connector connected correctly? Is the brightness of the LED light set to a dark value? 	p.40 p.71
Nothing is displayed when Amplifier Units are connected.	<ul style="list-style-type: none"> Is the power turned ON simultaneously for all of the connected Amplifier Units? 	p.16
Measurement results are not displayed.	<ul style="list-style-type: none"> Is the operating mode switch set to "RUN"? 	p.44
The TRIG signal (input signal) is not accepted.	<ul style="list-style-type: none"> Are all cables connected correctly? Is the signal line disconnected? Is the operating mode switch set to "RUN"? 	p.31 p.44
The OUTPUT signal is not output.	<ul style="list-style-type: none"> Is the TRIG signal being input? Are all cables connected correctly? Is the signal line disconnected? Is the operating mode switch set to "RUN"? 	p.31 p.44
The ENABLE signal does not turn ON.	<ul style="list-style-type: none"> Is the operating mode switch set to "RUN"? 	p.44
The bank is not switched even if the bank switching signal is input from the outside.	<ul style="list-style-type: none"> Is the bank switching method set to [I/O]? When the bank switching method is set to [KEY], only switching by key entry is enabled. For this reason, the external input of the BANK 1 to 3 are not accepted. Is the operating mode switch set to "RUN"? 	p.60 p.44





Error Messages and Remedies

Error messages	Cause	Countermeasure	Pages
BANK DATA ERROR	Error in the bank data	The bank data will be initialized, and must be reset.	-
HEAD IS NOT CONNECTED	The Sensor Head is not connected correctly.	Make sure that the Sensor Head is connected correctly.	p.38
NEIGHBOR UNIT IS NOT CONNECTED	The Amplifier Units are not coupled correctly.	Make sure that the Amplifier Units are connected correctly.	p.27
SYSDATA ERROR	Error in the system data.	The system data will be initialized, and must be reset.	-
SYSTEM ERROR ERROR CODE ??	Failed to configure FPGA. Failed to initialize LCD. Failed to recognize Amplifier Unit. Failed to load data from flash memory. Faulty hardware operation Faulty software operation	Faulty Amplifier Unit Contact your OMRON representative.	-
TEACHING FAILED	The workpiece is not projected correctly. The teaching area is not set at the appropriate position.	Set the area so that the workpiece is projected in the field-of-view. Make sure that the appropriate teaching area is set.	p.38 p.51

In the following instances, error messages are not displayed, but the ERROR signal turns ON.

Cause	Countermeasure	Pages
TRIG was input while ENABLE was OFF.	Wait until ENABLE is turned ON and then input TRIG.	p.34
Failed to teach from external device.	Set the area so that the workpiece is projected in the field-of-view. Make sure that the appropriate teaching area is set. Make sure that TRIG timing is appropriate in the workpiece move teaching mode.	p.38 p.51 p.34

Q&A

Question	Answer
Can I turn LED light emission of the Sensor Head OFF?	<p>Yes, you can. [CUSTM]-[Set LIGHT] to [0000].  p.71</p>
What should I do to set the measurement time as short as possible?	<p>There are two ways of setting a shorter measurement time:</p> <ul style="list-style-type: none"> • [Set CUSTM]-[IMAGE RATE] to [HIGH SPEED]. Note, however, that image processing becomes rougher, and measurement accuracy drops.  p.61 • Switch the screen display during measurement to "Display only image". The measurement time can be reduced proportionate to the reduction in display time.  p.59
Teaching is not going well. What should I do?	<ul style="list-style-type: none"> • Workpiece move teaching mode A probable cause is that the workpiece is not properly in the teaching area as intended. Change to the workpiece stop teaching mode or teaching by key operation. • A probable cause is that teaching is not successful because an image is too dark or too bright. Adjust light emission at [CUSTM]-[LIGHT] so that the workpiece is projected clearly, and execute teaching again.  p.71 • Does it switch to the teaching area MOVE (move) screen or SIZE (Resize) screen? Teaching cannot be performed from the MOVE screen or SIZE screen. Set the position or size with the SET key, go back 1 screen up then press the teaching button.
At what timing are set measurement conditions saved to the amplifier unit?	<p>Set measurement conditions are saved to the amplifier unit "when external TEACH signal teaching is successful" or "when switched to RUN mode." When the TEACH key is pressed from the teaching screen to teach, contents will not be saved unless switched to RUN mode once. Changed contents, including teaching results, are cleared when switching off without saving.</p>
Even though I change the search area for SEARCH/MATCH, the search is done outside the search area.	<p>If the CUSTM setting has been changed, perform the teaching again.</p>

Run Mode Display Item List

The following tables show the characters that are displayed on the LCD monitor and their meanings

Characters in parentheses () are the characters that are displayed in the enlarged display mode.

■ Items displayed in common at [ITEM]

Display Characters	Meaning
AVE	Average value of measurement result
DRANGE	Min. and max. of measurement result XX – YY (min. value – max. value)
JG	Judgment result (OK/NG)
MCONT	Measurement count (1 to 9999999)
NG%	NG occurrence ratio (NG count/measurement count)
TH	Judgment threshold value In the case of the upper/lower limits, XX – YY (lower limit – upper limit) is displayed.
TIME	Measurement time The shortest measurement time when the display image is set to “Display only image”.

■ Items displayed individually

● SEARCH, MATCH, CHARA 2

Display Characters	Meaning
SCORE(SCR)	Correlation values of calculated model

● BRIGHT

Display Characters	Meaning
DENAVE(DAV)	Density average value
DENDEV(DEV)	Density distribution value

● AREA

Display Characters	Meaning
MES	Area value (value obtained by normalizing with area value during teaching taken as 100)

● POSITION

Display Characters	Meaning
GAP	Deviation from reference position

● WIDTH

Display Characters	Meaning
WID	Edge width

● **COUNT**

Display Characters	Meaning
COUNT(CNT)	Count

● **CHARA 1**

Display Characters	Meaning
DENDEV(DEV)	Density distribution value

When Gang-mounting Amplifier Units

Application examples of amplifier unit gang-mounting and caution notes are explained.

Gang-mounting example

■ 1 sensor head + multiple amplifier units

Example of detection of input image from 1 sensor head with multiple amplifier units.

- To detect multiple areas such as a 4-sided POSITION, multiple item SEARCH, etc.
- To detect multiple types such as both SEARCH and AREA judgments.

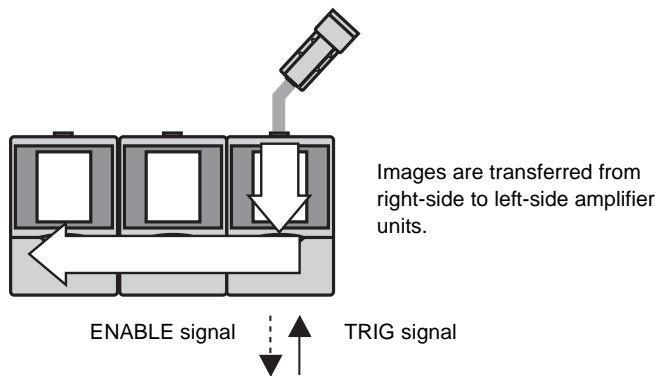

■ Multiple sensor heads + multiple amplifier units

Example of synchronizing and detecting multiple points of the same workpiece and integrating judgments.

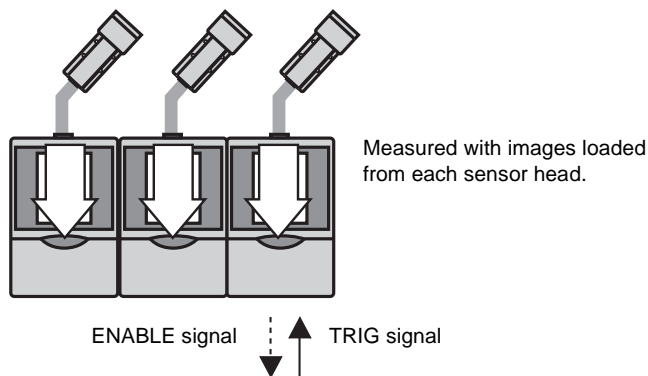

Rules of gang-mounting

Item	Rules
No. of Amplifier Units connectable	Maximum 5
No. of mounted sensor heads	Up to the number of amplifier units
TRIG signal input	Only host device is enabled
TEACH signal input	Only host device is enabled
BANK1-3 input	Enabled at each amplifier unit
ENABLE output	Only host device is enabled
OUTPUT output	Depends on the settings (Integrated judgment/Individual judgment)
ERROR output	Enabled at each amplifier unit
MENU/ADJ/RUN	Only host device is enabled
STD/EXP	Enabled at each amplifier unit
All key inputs	Enabled at each amplifier unit

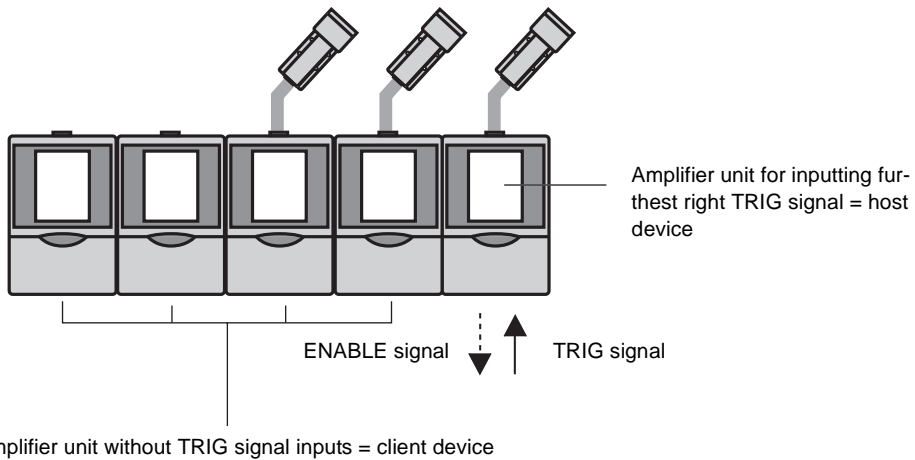

Data route

■ Measurement image

The measurement image flows from the right-side amplifier unit towards the left-side. Image input timing delays do not occur.

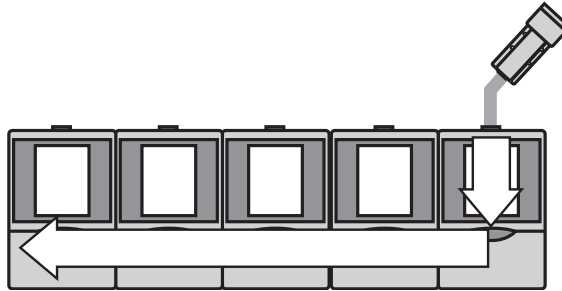

■ I/O signal

The TRIG signal flows from the right-side amplifier unit towards the left-side. Input timing delays do not occur.

In contrast, ENABLE signals and OUTPUT signals combining all amplifying units can be output from the furthest right amplifier unit as ENABLE signals and OUTPUT signals flow from the left-side amplifier unit to the right-side.

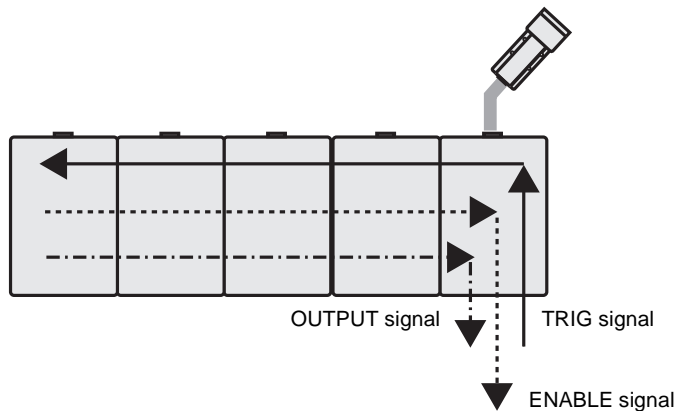

Teaching process when gang-mounting

■ Teaching (key input) from MENU Mode

Enter the teaching screen from the host device and press the TEACH key to teach all clients in the teaching screen where the host device is added.

Enter the teaching screen for the client only and press the TEACH key to teach only this client.

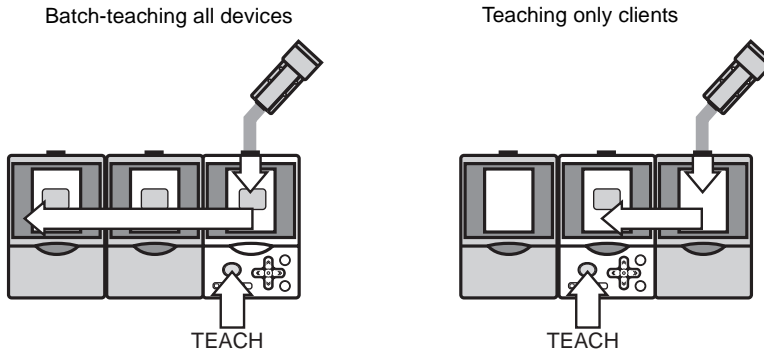

■ External teaching

The TEACH signal is input from the host device. Input the host device ENABLE signal at ON. Teaching is completed when the host device ENABLE signal is set OFF→ON after teaching is performed. It is ignored even if a TEACH signal is input to the client.

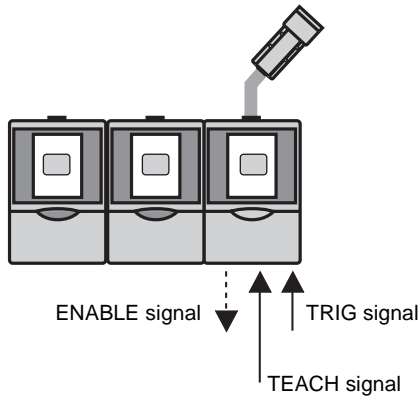

The time required to perform the teaching process increases when gang-mounted. In particular, when performing move teaching, raise the TRIG signal input interval to 200ms minimum.

CHECK!

Integrating judgment output

Judgment result output (OUTPUT) of gang-mounted amplifier units can be integrated.

 Setting output content p.70

■ When all amplifier unit measurement results are integrated (ALL)

Select [ALL] to integrate measurement results of all gang-mounted amplifier units and output from amplifier units (host device) where TRIG signals are input. Obtain OUTPUT signal after ENABLE signal is set to ON.

When any amplifier unit is NG, the integrated judgment is NG.

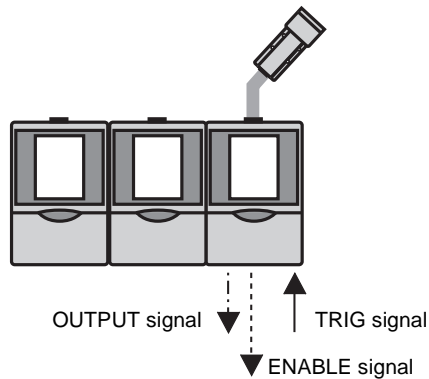

■ When judgment results are output by each amplifier unit (EACH)

Select [EACH] to output judgment results by each amplifier unit. The host device ENABLE signal is enabled. Obtain OUTPUT signal after ENABLE signal is set to ON.

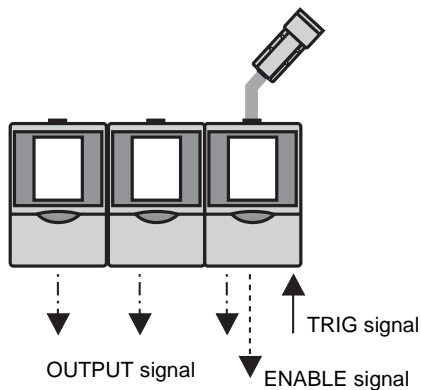

Restrictions when gang-mounting old and new amplifier units

Restrictions on gang-mounting between ZFV-A□□ units are explained.

The amplifiers below (hereinafter new amplifiers) and amplifiers with serial numbers previous to this (hereinafter old amplifiers) cannot be gang-mounted.

ZFV-A10	SER No.0863Y04 or later
ZFV-A15	SER No.0060Y04 or later
ZFV-A20	SER No.0834Y04 or later
ZFV-A25	SER No.0032Y04 or later



CHECK!

- Old-old amplifiers or new-new amplifiers can be gang-mounted without problems occurring.
- Old amplifiers and new amplifiers can be distinguished by checking the model notations on the face plate affixed to the bottom side of the amplifier.

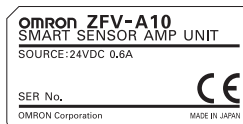

Old amplifier

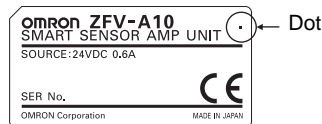

New amplifier

- Please contact our sales department for more information.

Specifications and External Dimensions

Sensor Head

ZFV-SR10/SR50

(Unit: mm)

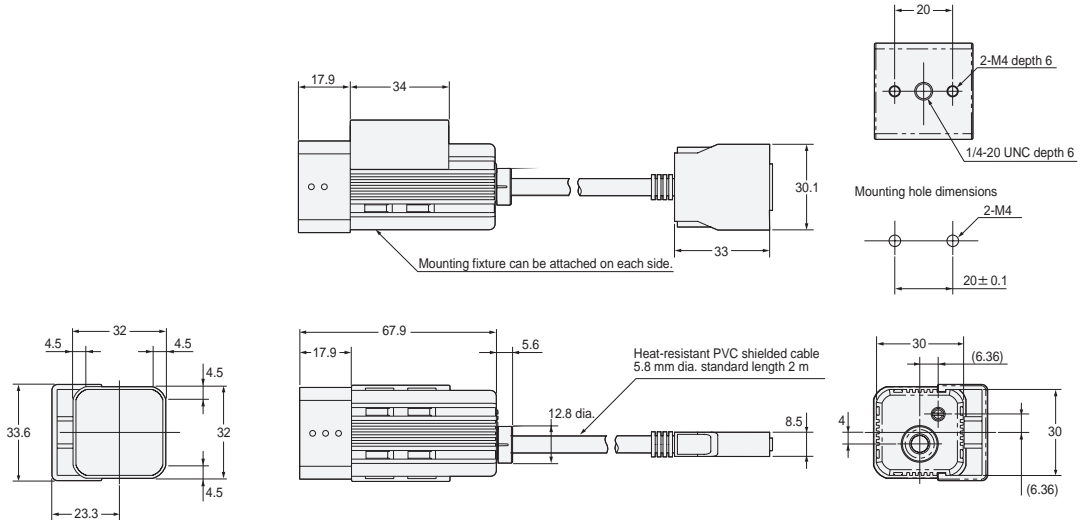

Section 4 Specifications and External Dimensions

Item	ZFV-SR10 (Narrow View)	ZFV-SR50 (Wide View)
Setting distance (L)	34 to 49 mm	38 to 194 mm
Detection range (H×V)	5 × 4.6 mm to 9 × 8.3 mm	10 × 9.2 mm to 50 × 46 mm
Relation between setting distance and detection range	<p>Setting distance (L)</p> <p>Detection range (H)</p>	<p>Setting distance (L)</p> <p>Detection range (H)</p>
Guide light	Provided (center, sensing area)	
Built-in lens	Focus: f15.65	Focus: f13.47
Object lighting method	Pulse lighting	
Object light source	Eight red LEDs	
Sensing element	1/3-inch CCD, partial scan	
Shutter	Electronic shutter, shutter time: 1/1,000 to 1/4,000	
Power supply voltage	15 VDC (Supplied from Amplifier Unit.)	
Current consumption	Approx. 200 mA	
Dielectric strength	1,000 VAC, 50/60 Hz for 1 min	
Vibration resistance (destruction)	10 to 150 Hz, 0.35-mm single amplitude, 10 times each in X, Y, and Z directions for 8 min	
Shock resistance (destruction)	150 m/s ² , three times each in six directions (up/down, left/right, forward/backward)	
Ambient temperature	Operating: 0 to 40 °C, Storage: -20 to 65°C (with no icing or condensation)	
Ambient humidity	Operating and storage: 35% to 85% (with no condensation)	
Ambient atmosphere	Must be free of corrosive gas.	
Connection method	Prewired, Standard cable length: 2 m	
Degree of protection	IEC60529, IP65	
Materials	Case: ABS, Mounting bracket: PBT	
Weight	Approx. 200 g (including mounting bracket and cord)	
Accessories	Mounting bracket (1), Ferrite core (1), Instruction sheet	

Amplifier Unit

ZFV-A□□

(Unit: mm)

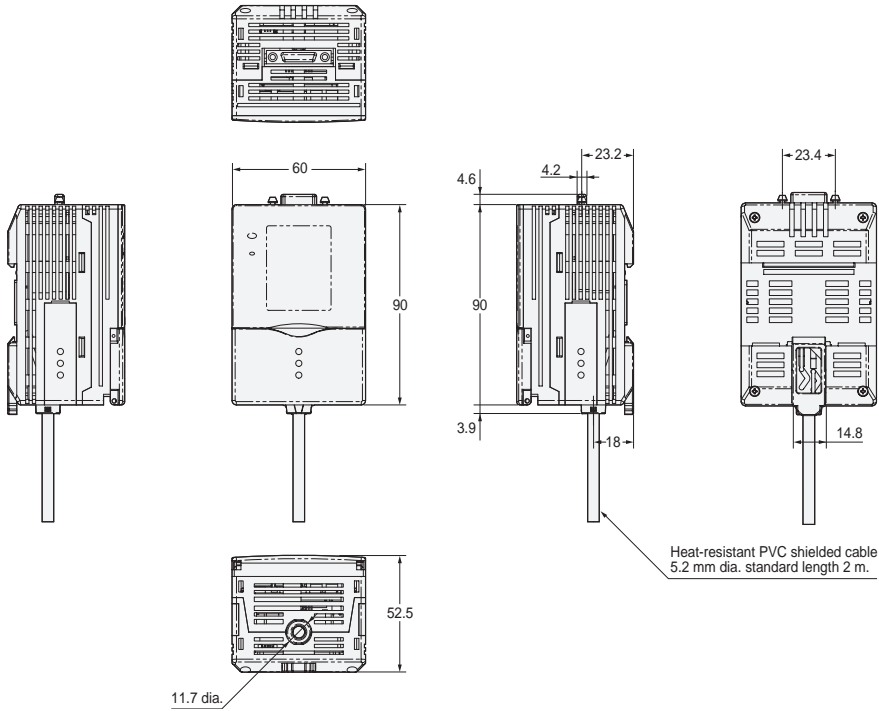

Item	Single-function Models		Standard Models	
	ZFV-A10	ZFV-A15	ZFV-A20	ZFV-A25
Output method	NPN	PNP	NPN	PNP
Output specifications	NPN: NPN open-collector, 30 VDC, 50 mA max., residual voltage: 1.2 V max. PNP: PNP open-collector, 50 mA max., residual voltage: 1.2 V max.			
Input specifications	NPN: At ON: maximum 0V short circuit or maximum 1.5V, At OFF: open circuit (Leakage current at maximum 0.1 mA) PNP: At ON: power supply voltage short circuit or power supply voltage within -1.5V, At OFF: open circuit (Leakage current at maximum 0.1 mA)			
Inspection items	Pattern (PTRN), Brightness (BRGT)		Patterns (PTRN), Brightness (BRGT), Area (AREA), Width (WID), Position (POSI), Count (CNT), Characters (CHAR)	
Teaching area	Rectangular, one area			
Teaching area size	<ul style="list-style-type: none"> • Pattern (PTRN), Brightness (BRGT): Any rectangular area (256 × 256 max.) • Area (AREA), Width (WID), Position (POSI), Count (CNT), Characters (CHAR): Any rectangular area (full screen max.) 			
Sensing area	Full screen			
Resolution	468 × 432 (H × V) max.			
Bank selection	Supported for 8 banks.			
Response time	Pattern (PTRN), Brightness (BRGT): High-speed: 4 ms, Standard: 8 ms, High-precision: 12 ms Area (AREA), Width (WID), Position (POSI), Count (CNT), Characters (CHAR): 128 × 128: 15 ms max.			
Other functions	Control output switching: ON for OK or ON for NG ON delay/OFF delay, One-shot output, "ECO" mode			
Output signals	(1) Control output (OUTPUT), (2) Enable output (ENABLE), (3) Error output (ERROR)			
Input signals	(1) Simultaneous measurement input (TRIG) or Continuous measurement input (TRIG), Switched by using menu. (2) Bank selection inputs (BANK1 to BANK3) (3) Workpiece still teaching (TEACH) or Workpiece moving teaching (TEACH), Switched by using menu.			
Sensor Head interface	Digital interface			
Image display	Compact TFT 1.8-inch LCD (Display dots: 557 × 234)			
Indicators	• Judgement result indicator (OUTPUT) • Inspection mode indicator (RUN)			
Operation interface	<ul style="list-style-type: none"> • Cursor keys (up, down, left, right) • Setting key (SET) • Escape key (ESC) • Operating mode switching (slide switch) • Menu switching (slide switch) • Teaching/Display switching key (TEACH/VIEW) 			
Power supply voltage	20.4 to 26.4 VDC (including ripple)			
Current consumption	600 mA max. (with Sensor Head connected)			
Dielectric strength	1,000 VAC, 50/60 Hz for 1 min between leads and Amplifier Unit case			
Noise immunity	1 kV, Pulse rise: 5 ns, Pulse width: 50 ns, Burst duration: 15 ms, Cycle: 300 ms			
Vibration resistance	Destruction: 10 to 150 Hz, 0.1-mm single amplitude, 10 times each in X, Y, and Z directions for 8 min			
Shock resistance	Destruction: 150 m/s ² , three times each in six directions (up/down, left/right, forward/backward)			
Ambient temperature	Operating: 0 to 50°C Storage: -25 to 65°C (with no icing or condensation)			

Item	Single-function Models		Standard Models	
	ZFV-A10	ZFV-A15	ZFV-A20	ZFV-A25
Ambient humidity	Operating and storage: 35% to 85%			
Ambient atmosphere	Must be free of corrosive gas.			
Degree of protection	IEC60529, IP20			
Materials	Polycarbonate			
Weight	Approx. 300 g (including cord)			
Accessories	Ferrite core (1), Instruction sheet			

Panel Mount Adapters

ZS-XPM1/XPM2

When mounting on a panel

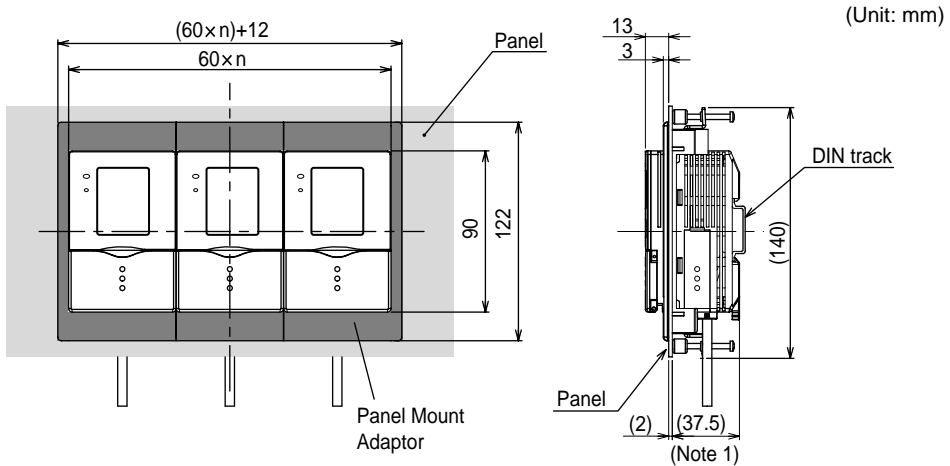

Note 1 : Dimensions are shown for a panel thickness of 2.0 mm.

Panel cutout dimensions

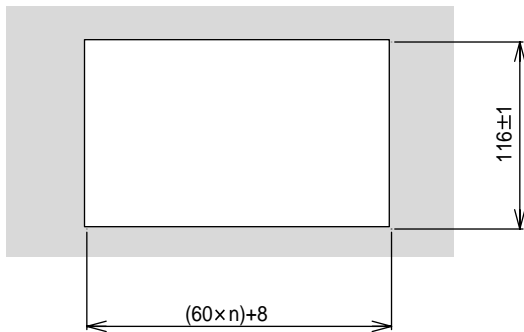

n : Number of gang-mounted controllers (1 to 10)

Item	ZS-XPM1 (for 1st unit)	ZS-XPM2 (for 2nd unit onwards)
Appearance		
Vibration resistance (destructive)	10 to 150 Hz, 0.7-mm double amplitude, 80 min each in X, Y, and Z directions	
Shock resistance (destructive)	300 m/s ² 3 times each in six directions (up/down, left/right, forward/backward)	
Materials	Polycarbonate (PC), etc.	
Weight	Approx. 50g	

Control Link Unit

ZS-XCN

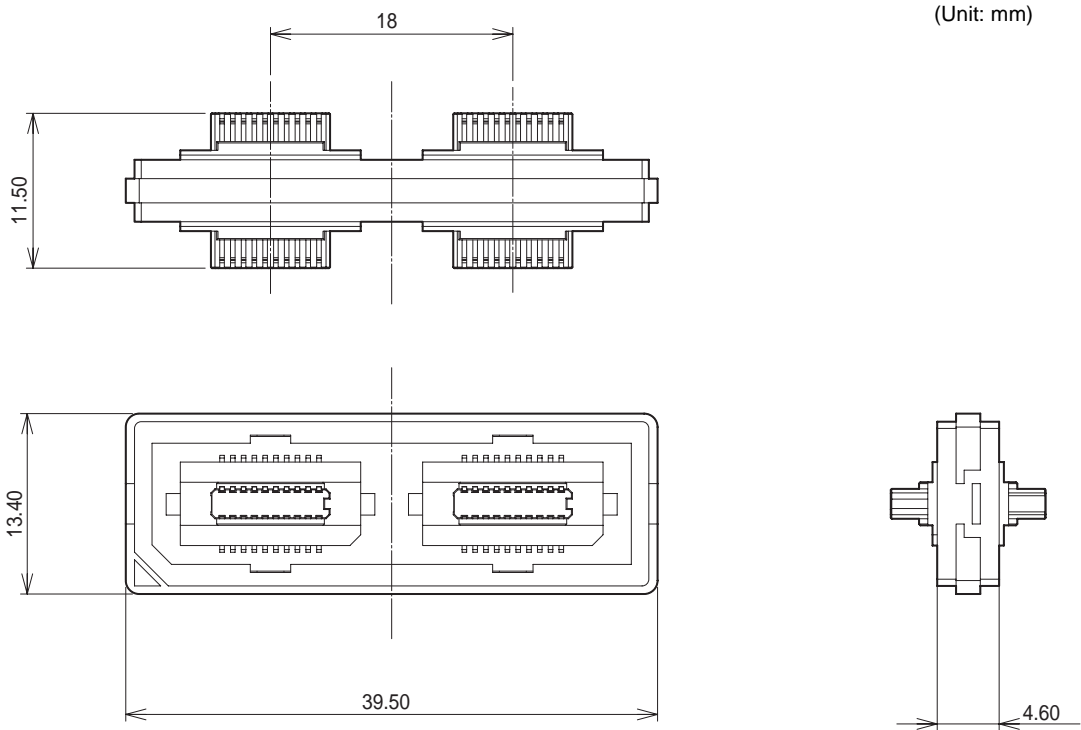

Item	ZS-XCN
Ambient temperature	Operating: 0 to 50°C, Storage: -15 to +60°C (with no icing or condensation)
Ambient humidity	Operating and storage: 35% to 85% (with no condensation)
Vibration resistance (destructive)	10 to 150 Hz, 0.7-mm double amplitude, 80 min each in X, Y, and Z directions
Shock resistance (destructive)	300 m/s ² 3 times each in six directions (up/down, left/right, forward/backward)
Materials	Polycarbonate (PC), etc.
Weight	Approx. 10g

Extension Cord

ZFV-XC□B(R)V2

(Unit: mm)

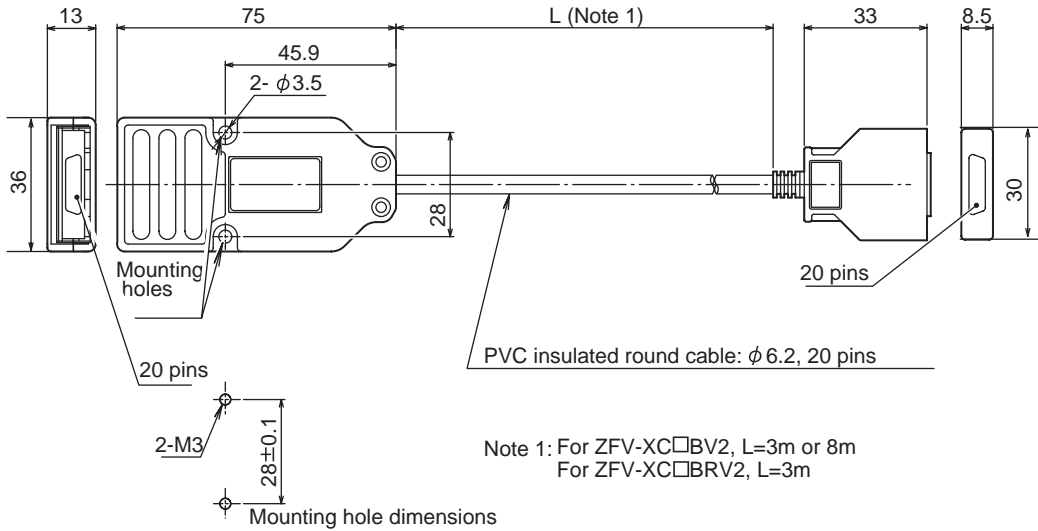

Item	ZFV-XC3BV2	ZFV-XC8BV2	ZFV-XC3BRV2*
Applicable Amplifier Units	ZFV-A Series		
Applicable Sensor Head	ZFV-S Series		
Ambient temperature	Operating: 0 to +40°C, Storage: -25°C to +65°C (with no icing or condensation)		
Ambient humidity	Operating and storage: 35% to 85% (with no condensation)		
Connection type	Double-sided connector		
Material	Case: Polycarbonate (PC)		
Weight	Approx. 220g	Approx. 500g	Approx. 220g
Cord length	3m	8m	3m

* Model Nos. appended with "R" are robot cable types.

Version Up Information

Software version upgrade contents are explained.

■ Ver1.00 → Ver2.00

Changes	Reference
A function for logging measurement images and measurement values together when connecting to the data storage unit type ZS-DSU added	*
A function for clearing measurement values added	p.62
A function for setting teaching screen image capture timing added	p.63
A function for setting the communications environment added	p.64
An I/O monitor function (Function to check I/O signal status) added	p.68
Added ↑ ← to edge detection direction	p.76
A function to change edge detectivity added	p.76
A function to improve character detection stability added	p.78

*: Refer to the data storage unit ZS-DSU User's Manual

INDEX

A

ADJ mode	44
Adjusting light emission	71
ALL CLEAR	62
Amplifier Unit	23
Attaching the ferrite core	23
Installing the Amplifier Unit	23
restrictions when gang-mounting	94
Specifications and External Dimensions	97
Application Expanded Configuration	16
Application extended connection	69
Area value	56
AVERAGE	73
Average density value	55

B

BANK	60
Bank	60
bank extension	15
Clearing banks	60
Copying banks	60
Setting the bank switching method	60
Switching banks	60
Binarization	74
BINARY	74

C

CLEAR	60
COLOR	74, 76, 77, 80
COM	64
COPY	60
Correlation value	55, 58
Coupler	19

D

Data Storage Unit	15
Density deviation value	55
Density distribution value	58
Detection content	51
Brightness/scratches, dirt	51
Characters	51

Number	51
Pattern/shape/presence	51
Position	51
Size/area	51
Width	51
Detection range	38, 96
DEVIATION	73
DIRECTION	75, 76, 77, 80

E

ECO MODE	62
“Eco” mode	62
Edge	75
Color of edges	75, 76, 77
detectivity	76
Edge detection direction	75, 76, 77
Edge level	56, 57
EDGE SENSE	76
Edge width	56
Expert menu	44
Extension cord	102

F

Focus adjustment control	20
FREEZE	63

G

Gang mounting	27
---------------	----

I

I/O cable	31
I/O Circuit Diagrams	32
I/O MON	68
IMAGE RATE	61
Initializing	
measurement data	62
setup data	62
Initializing setup data	62
Input/output	65
ON conditions	65
One-shot output	65
Installation	22
DIN track	23

Gang mounting	27
Panel	25
Installation distance	38

K

Key Operations	45
----------------	----

L

LIGHT	71
Logging	15

M

MDL DIV	78
MEAS CLEAR	62
MEAS TYPE	61
Measurement	59
Adjusting the measurement speed	61
Measurement time	59
Measurement timing	61
Switching the display during measurement	59
MENU mode	44
Description of MENU mode	44
List of Setting Items	46
Menu selector switch	18
METHOD	73
MODE	79
Mode	44
Mode selector switch	18
MODEL	79

N

Narrow View	96
NORMAL	76
Number	57

O

OFF DELAY	67
OFF delay time	67
ON DELAY	66
ON delay time	66
ON STATUS	65
ONE SHOT	66
One-shot output	65

Continuous measurement	65
Output time	66
Synchronous measurement	65
Operating modes	44
OUTPUT	68, 70
OUTPUT TIME	66

P

Part Names and Functions	18
Amplifier Unit	18
Sensor Head	20
Position	57
Power supply	16

R

ROTATION	72
Rotation range	72
ROUGH	76
RUN mode	44

S

Saving the Set Measurement	
Conditions	82
SEARCH AREA	72, 81
Search area	72
SENSITIVE	76
Sensor Head	37
Attaching the ferrite core	37
Connecting the Sensor Head	40
Installation distance	38
Installing the mounting fixture	37
Specifications and External Dimensions	95
Single-function Models	98
STABLE	81
Standard menu	44
Standard Models	98
SWITCH	60
Switching menus	44
Switching the display	59

T

TEACH IMAGE	63
TEACH TYPE	61
Teaching	35
AREA	52

BRIGHT	52
CHARA	54
COUNT	53
PATTERN	51
POSITION	53
Teaching Flow	48
Types of Teaching	51
WIDTH	53
Workpiece move teaching	36
Workpiece stop teaching	35
Teaching Key Operations and Screen Transition	50
Threshold Values	55
AREA	56
BRIGHT	55
CHARA 1	58
CHARA 2	58
COUNT	57
MATCH	55
POSITION	57
SEARCH	55
WIDTH	56
THROUGH	63
Timing charts	34
Continuous measurement	34
Synchronous measurement	34
TRIG	69

V

VERSION	63
Version	63

W

Wide View	96
-----------	----

Revision History

A manual revision code appears as a suffix to the catalog number at the bottom of the front and back covers of this manual.

Cat. No. Z207-E1-03

↑
Revision code

Revision code	Date	Revised contents
01	August 2004	Original production
02	March 2005	Functions added as per software version upgrade (Ver2.00) Information on extension cord ZFV-XC□B(R) added
03	August 2006	<p>Page 5: Change made to the second line of the last bulleted item.</p> <p>Page 40: Third bulleted item added to description of Connecting the Sensor Head.</p> <p>Page 42: "Saving the set measurement conditions" step added to the Setting Flow.</p> <p>Page 57: Edge level setting item added to table.</p> <p>Page 82: "Saving the set measurement conditions" item added.</p> <p>Page 84: Question about display problem when Amplifier Units are connected added to the troubleshooting list.</p> <p>Page 85: BANKDATA ERROR and SYSDATA ERROR added to error messages in table.</p> <p>Page 86: Information on SEARCH/MATCH search area added to Q&A.</p>