



**THERMOSTATICALLY CONTROLLED WALL MOUNTED
UNVENTED GAS HEATER WIR1-WIR2
(Equipped with Pilot Light Safety System)**



WARNING: If the information in this manual is not followed exactly, a fire or explosion may result causing property damage, personal injury, or loss of life.

- Do not store or use gasoline or other flammable vapors and liquids in the vicinity of this or any other appliance.
- **WHAT TO DO IF YOU SMELL GAS**
- Do not try to light any appliance.
- Do not touch any electrical switch; do not use any phone in your building.
- Immediately call your gas supplier from a neighbor's phone. Follow the gas supplier's instructions.
- If you cannot reach your gas supplier, call the fire department.
- Installation and service must be performed by a qualified installer, service agency, or the gas supplier.

WARNING: Improper installation, adjustment, alteration, service, or maintenance can cause injury or property damage. Refer to this manual for correct installation and operational procedures. For assistance or additional information consult a qualified installer, service agency, or the gas supplier.

WARNING: This is an unvented gas-fired heater. It uses air (oxygen) from the room in which it is installed. Provisions for adequate combustion and ventilation air must be provided. Refer to *Air for Combustion and Ventilation* section on page 4 of this manual.

This appliance may be installed in an aftermarket*, permanently located, manufactured (mobile) home, not prohibited by local codes. This appliance is only for use with the type of gas indicated on the rating plate. This appliance is not convertible for use with other gases.

* Aftermarket: completion of sale, not for purpose of resale, from the manufacturer

SAVE THIS MANUAL FOR FUTURE REFERENCE

TABLE OF CONTENTS

Safety information	2	Operating heater	11
Local codes	3	Cleaning and maintenance	14
Product identification	3	Specifications	15
Unpacking	3	Troubleshooting	16
Product features	4	Service hints	15
Air for combustion and ventilation	4	Technical service	15
Installation	7	Warranty information	19

SAFETY INFORMATION

WARNING:

IMPORTANT: Read this owner's manual carefully and completely before trying to assemble, operate, or service this heater. Improper use of this heater can cause serious injury or death from burns, fire, explosion, electrical shock, and carbon monoxide poisoning.

DANGER: Carbon monoxide poisoning may lead to death!

Carbon monoxide Poisoning: Early signs of carbon monoxide poisoning resemble the flu, with headaches, dizziness, or nausea. If you have these signs, the heater may not be working properly. **Get fresh air at once!** Have heater serviced. Some people are more affected by carbon monoxide than others. These include pregnant women, people with heart or lung disease or anemia, those under the influence of alcohol, and those at high altitudes.

Natural and Propane/LP Gas: Natural and propane/LP gases are fuel gases. Fuel gases are odorless. An odor-making agent are added to fuel gases. The odor helps you detect a fuel gas leak. However, the odor added to fuel gas can fade. Fuel gas may be present even though no odor exists.

Make certain you read and understand all warnings. Keep this manual for reference. It is your guide to safe and proper operation of this heater.

WARNING: Any change to this heater or its control can be dangerous.

WARNING: Do not use any accessory not approved for use with this heater.

Due to high temperatures, the appliance should be located out of traffic and away from furniture and draperies.

Do not place clothing or other flammable material on or near the appliance. Never place any objects on the heater.

Surface of heater becomes very hot when running heater. Keep children or adults away from the surface to avoid burns a clothing igniton. Heater will remain hot for a time after shut-down. Allow surface to cool before touching.

Carefully supervise young children when they are in the same room with heater.

Keep the appliance area clear and free from combustible materials, gasoline and other flammable vapors and liquids.

Any safety screen or guard removed for servicing an appliance must be replaced prior to operating the heater.

Installation and repair should be done by a qualified service person. The appliance should be inspected before use and at least annually by a professional service person. More frequent cleaning may be required due to excessive lint from carpeting, bedding material, etc. It is imperative that control compartments, burners and circulating air passageways of the appliance be kept clean.

1. This appliance is only for use with the type of gas indicated on the rating plate. This appliance is not convertible for use with other gases.
2. Do not place propane/LP supply tank(s) inside any structure. Place propane/LP supply tank(s) outdoors.
3. This heater shall not be installed in a bedroom or bathroom.
4. If you smell gas
 - Shut off gas supply
 - Do not try to light any appliance.
 - Do not touch any electrical switch; do not use any phone in your building.
 - Immediately call your gas supplier from a neighbor's phone. Follow the gas supplier's instructions
 - If you cannot reach your gas supplier, call the fire department.
5. Always run heater with plaque control knob 1,2,3 or at the 1,2, or 4 locked positions. Never set control knob between locked positions. Poor combustion and higher levels of carbon of monoxide may result.
6. This heater needs fresh, outside air ventilation to run properly. This heater has an Oxygen Depletion Sensing (ODS) safety shutoff system. The ODS shuts down the heater if not enough fresh air is available. See *Air for combustion and Ventilation*, pages 4 through.
7. If heater shut off, do not light again until you provide fresh, outside air. If heater keeps shutting off, have it service.
8. Do not run heater
 - where flammable liquids or vapors are used or stored
 - under dusty conditions
9. Do not use heater if any part has been under water. Immediately call a qualified service technician to inspect the room heater and to replace any part of the control system and any gas control which has been under water.
10. Turn off and unplug heater and let cool before servicing. Only a qualified service

- person should service and repair heater.
11. Operating heater above elevations of 4,500 feet could cause power outage.
12. To prevent performance problems, do not use propane/LP fuel tank of less than 100 lbs. capacity.
13. Before using furniture polish, wax, carpet cleaner, or similar products, turn heater off. If heated, the vapors from these products may create a white powder residue within burner box or on adjacent walls or furniture.
14. Provide adequate clearances around air openings.

LOCAL CODES

Install and use heater with care. Follow all local codes, use the latest edition of *National Fuel Gas Code, ANSI Z223.1/NFPA 54**

* Available from:

American National Standards Institute, Inc.
1430 Broadway
New York, NY10018

National Fire Protection, Inc
Batterymarch Park
Quincy, MA 02269

PRODUCT IDENTIFICATION

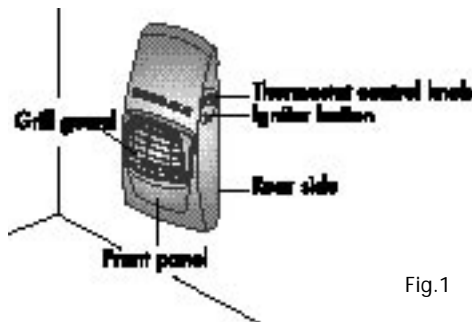

Fig.1

UNPACKING

1. Remove the heater from carton.
2. Remove all protective packaging applied to heater for shipment.
3. Check heater for any shipping damage. If heater is damaged, promptly inform dealer where you bought heater.

PRODUCT FEATURES

Safety device

This heater has a pilot with an Oxygen Depletion Sensing (ODS) safety shutoff system. The ODS/pilot is a required feature for vent-free room heaters. The ODS/pilot shuts off the heater if there is not enough fresh air.

Piezo ignition system

This heater has a piezo ignitor. This system requires no matches, batteries, or other sources to light heater.

AIR FOR COMBUSTION AND VENTILATION

WARNING: This heater shall not be installed in a confined space or unusually tight construction unless provisions are provided for adequate combustion and ventilation. Read the following instructions to ensure proper fresh air for this and other fuel-burning appliances in your home.

Today's home are built more energy efficient than ever. New materials, increased insulation, and new construction methods help reduce heat loss in homes. Home owners weather strip and caulk around windows and doors to keep the cold air out and the warm air in. During heating months, home owners want their homes as airtight as possible.

While it is good to make your home energy efficient, your home needs to breathe. Fresh air must enter your home. All fuel-burning appliances need fresh air for proper combustion and ventilation.

Exhaust fans, fireplaces, clothes dryers, and fuel burning appliances draw air from the house to operate. You must provide adequate fresh air for these appliances. This will ensure proper venting of vented fuel-burning appliances.

PROVIDING ADEQUATE VENTILATION

The following are excerpts from *National Fuel Gas Code, ANSI Z223.1/NFPA 54, Section 5.3 Air for Combustion and Ventilation*.

All spaces in homes fall into one of the three following ventilation classification:

1. Unusually Tight Construction
2. Unconfined Space
3. Confined Space

The information on page 4 through 6 will help you classify your space and provide adequate ventilation.

Unusually Tight Construction

The air that leaks around doors and windows may provide enough fresh air for combustion and ventilation. However, in buildings of unusually tight construction, you must provide additional fresh air.

Unusually tight construction is defined as construction where:

- a. walls and ceilings exposed to the outside atmosphere have a continuous water vapor retarder with a rating of one perm (6×10^{-11} Kg per pa-sec- m^2) or less with openings gasketed or sealed *and*
- b. weather stripping has been added on openable windows and doors *and*
- c. caulking or sealants are applied to areas such as joints around window and door frames, between sole plates and floors, between sole plates and floors, between wall panels, at penetrations for plumbing, electrical, and gas lines, and at other openings.

If your home meets all of three criteria above, you must provide additional fresh air. See Ventilation Air From Outdoors, page 6

If you home does not meet all of the three criteria above, proceed to Determining Fresh-Air Flow For Heater Location, page 5

Confined and Unconfined Space

The *National Fuel gas Code, ANSI Z223.1/NFPA 54* defines a confined space as a space whose volume is less than 50 cubic feet per 1,000 Btu per hour (4,8 m³ per kw) of the aggregate input rating of all appliances installed in that space and an unconfined space as a space whose volume is not less than 50 cubic feet per 1,000 Btu per hour (4,8 m³ per kw) of the aggregate input rating of all appliances installed in that space. Rooms communicating directly with the space in which the appliances are installed*, through openings not furnished with doors, are considered a part of the unconfined space.

*Adjoining rooms are communicating only if there are doorless passageways or ventilation grilles between them.

DETERMINING FRESH-AIR FLOW FOR HEATER LOCATION.

Determining if you have a confined or unconfined space.

Use this work sheet to determine if you have a confined or unconfined space.

Space: includes the room in which you will install heater plus any adjoining rooms with doorless passageways or ventilation grilles between the rooms.

1. Determine the volume of the space (length x width x height).

length x width x height = _____ cu.ft.
(volume of space)

Example: space size 20ft. (length) x 16 ft (width) x 8ft (ceiling height) = 2560 cu. ft. (volume of space)

If additional ventilation to adjoining room is supplied with grilles or openings, add the volume of these rooms to the total volume of the space.

2. Multiply the space volume by 20 to determine the maximum Btu/Hr the space can support.

_____ (volume of space) x 20= 51.200

(maximum Btu/Hr the space can support)

Example: 2560 cu. ft (volume of space) x 20= 51.200 (maximum Btu/Hr the space can support)

3. Add the Btu/Hr of all fuel burning appliances in the space.

Vent-free heater	_____	Btu/Hr
Gas water heater*	_____	Btu/Hr
Gas furnace	_____	Btu/Hr
Vented gas heater	_____	Btu/Hr
Gas fireplace logs	_____	Btu/Hr
Other gas appliances*	+ _____	Btu/Hr
Total	= _____	Btu/Hr

* Do not include direct-vent gas appliances. Direct-vent draws combustion air from the outdoors and vents to the outdoors.

Example

Gas water heater*	<u>40,000</u>	Btu/Hr
Vent-free heater	+ <u>20,000</u>	Btu/Hr
Total	= <u>60,000</u>	Btu/Hr

4. Compare the maximum Btu/Hr the space can support with the actual amount of Btu/Hr used.

_____ Btu/Hr (maximum the space can support)
_____ Btu/Hr (actual amount of Btu/Hr used)

Example: 51,200 Btu/Hr (maximum the space can support)
60,000 Btu/Hr (actual amount of Btu/Hr used)

The space in the above example is a confined space because the actual Btu/Hr used is more than the maximum Btu/Hr the space can support. You must provide additional fresh air.

Your options are as follows:

- A. Rework worksheet, adding the space of an adjoining room. If the extra space provides an unconfined space, remove door to adjoining room or add ventilation grills between rooms. See ventilation air from inside building, page 4
- B. Vent room directly to outdoors. See ventilation air from outdoors, page 4
- C. Install a lower Btu/Hr heater, if lower Btu/Hr size makes room unconfined.

If the actual Btu/Hr used is less than the maximum Btu/Hr the space can support, the space is an unconfined space. You will need no additional fresh air ventilation.

WARNING: if the area in which the heater may be operated is smaller than that defined as an unconfined space or if the building is of unusually tight construction, provide adequate combustion and ventilation air by one of the methods described in the National Fuel Gas Code, ANSI Z223.1/NFPA 54 section 5.3 or applicable local codes.

VENTILATION AIR

Ventilation Air From Inside Building

This fresh air would come from an adjoining unconfined space.

When ventilating to an adjoining unconfined space, you must provide two permanent openings: one within 12" of the ceiling and one within 12" of the floor on the wall connecting the two spaces (see options 1 and 2, figure ??). Follow the *National Fuel Gas Code, ANSI Z223.1/NFA 54, section air for combustion and ventilation* for required size of ventilation grills or ducts.

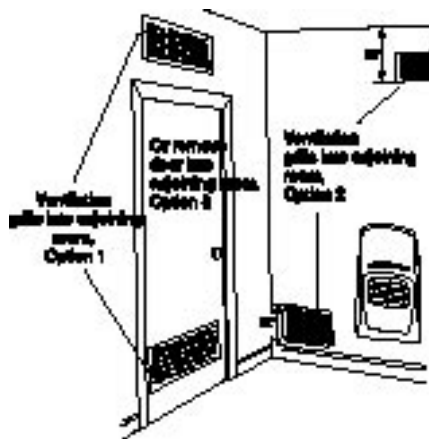

Fig.2 Ventilation Air from Inside Building

Ventilation Air From Outdoors

Provide extra fresh air by using ventilation grilles or ducts. You must provide two permanent openings: one within 12" of the ceiling and one within 12" of the floor. Connect these items directly to the outdoors. These spaces include attics and crawl spaces. Follow the *National Fuel Gas Code, ANSI Z223.1/NFA 54, section air for combustion and ventilation* for required size of ventilation grills or ducts.

IMPORTANT: Do not provide openings for inlet or outlet air into attic has a thermostat-controlled power vent. Heated air entering the attic will activate the power vent.



Fig.3 Ventilation Air From Outdoors

INSTALLATION

NOTICE: This heater is intended for use as a supplemental heat. Use this heater along with your primary heating system. Do not install this heater as your primary heat source. If you have a central heating system, you may run system's circulating blower while using heater. This will help circulate the heat throughout the house. In the event of a power outage, you can use this heater as your primary heat source.

WARNING: A qualified service person must install heater. Follow all local codes.

CHECK GAS TYPE

Use only the correct type of gas (natural or propane/LP). If your gas supply is not the correct gas type, do not install heater. Call dealer where you bought heater for proper type heater.

INSTALLATION ITEMS

Before installing heater, make sure you have the items listed below.

- for propane/LP gas, external regulator (supplied by installer)
- piping (check local codes)
- sealant (resistant to propane/LP gas)
- equipment shutoff valve*
- ground joint union
- test gauge connection*
- sediment trap
- tee joint
- pipe wrench
- for natural gas, test gauge connection*

LOCATING HEATER

This heater is designed to be mounted on a wall.

WARNING: maintain the minimum clearances shown in figure 4 if you can, provide greater clearances from floor, ceiling, and joining wall.

WARNING: Never install the heater

- in the bathroom
- in a recreational vehicle
- where curtains, furniture, clothing, or other flammable object are less than 36 inches

from the front, top, or sides of the heater.

- as a fireplace insert
- in high traffic areas
- in windy or drafty area

CAUTION: if you install the heater in a home garage

- heater pilot and burner must be at least 18 inches above floor
- place heater where moving vehicle will not hit it.

CAUTION: This heater creates warm air currents. These currents move heat to wall surfaces next to heater. Installing heater next to vinyl or cloth wall coverings or operating heater where impurities (such as, but not limited to, tobacco smoke, aromatic candles, cleaning fluids, oil or kerosene lamps, etc.) in the air exist, may discolor walls or cause odors.

IMPORTANT: vent-free heaters add moisture to the air. Although this is beneficial, installing heater in rooms without enough ventilation air may cause mildew to form from too much moisture. See air for Combustion and Ventilation, pages 4 through 6 . If high humidity is experienced, a dehumidifier may be used to help lower the water vapor content in the air.

For convenience and efficiency, install heater

- Where there is easy access for operation, inspection, and service.
- In coldest part of room.

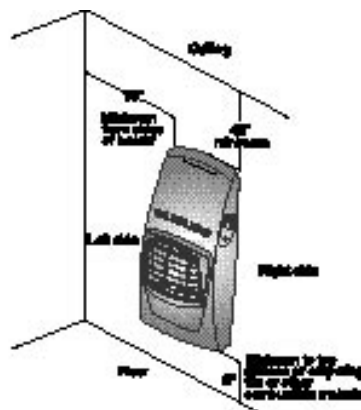
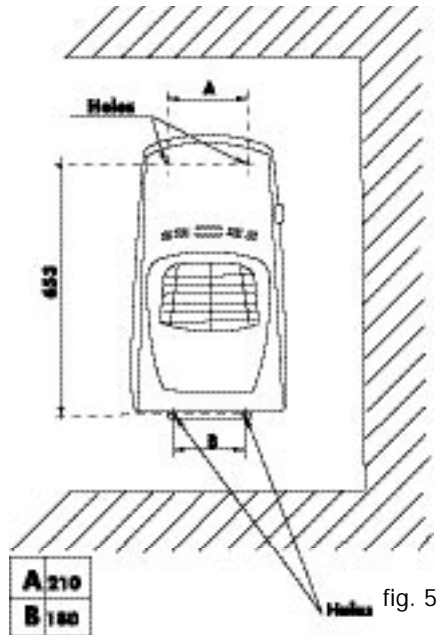

Fig.4 Mounting Clearances As Viewed From Front of Heater

INSTALLATION



- Sign in the wall to make the hole "A".
- Drill the wall by using a 1/4" drill.
- Insert the two plastic expansion anchors supplied in the installation kit, in the holes.
- Insert two of the four screws supplied in the holes letting them stick out from the wall for at least 5 mm (see fig. aside)
- Hook the appliance and label the holes B.
- Remove the appliance and by using the same drill as before, drill the holes. Insert the removing 2 plastic anchors.
- Hook the appliance and fix it in the lower part, by using the remaining 2 screws.



CONNECTING TO GAS SUPPLY

WARNING: This appliance requires a 3/8" NPT (National Pipe Thread) inlet connection to the pressure regulator.

WARNING: A qualified service person must connect heater to gas supply. Follow all local codes.

WARNING: For natural gas, never connect heater to private (non-utility) gas wells. This gas is commonly known as wellhead gas.

IMPORTANT: For natural gas, check gas line pressure before connecting heater to gas line. Gas line pressure must be no greater than 14 inches of water. If gas line pressure is higher, heater regulator damage could occur.

CAUTION: For propane/LP gas, never connect heater directly to the propane/LP supply. This heater requires an external regulator (not supplied). Install the external regulator between the heater and propane/LP supply.

For propane/LP gas, the installer must supply an external regulator. The external regulator will reduce incoming gas pressure to between 11 and 14 inches of water. If you do not reduce incoming gas pressure, heater regulator damage could occur. Install the external regulator with the vent pointing down as shown in figure 6. Pointing the vent down protects it from freezing rain or sleet.

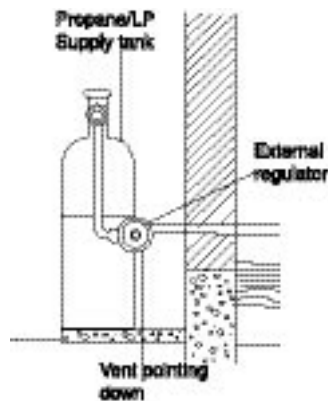

Fig.6 External Regulator With Vent Pointing Down

CAUTION: Use only new, black iron or steel pipe. Internally-tinned copper tubing may be used in certain areas. Check your local codes. Use pipe of large enough diameter to allow proper gas volume to heater. If pipe is too small, undue loss of volume will occur.

Installation must include equipment shutoff valve, union, and plugged 1/8" NPT tap. Locate NPT tap within reach for test gauge hook up. NPT tap must be upstream from heater (see fig 7)

IMPORTANT: install an equipment shutoff valve in accessible location. The equipment shutoff valve is for turning on or shutting off the gas to the appliance.

Apply pipe joint sealant lightly to male NPT threads. This will prevent excess sealant from going into pipe. Excess sealant in pipe could result in clogged heater valves.

WARNING: Use pipe joint sealant that is resistant to liquid petroleum (LP) gas.

Install sediment trap in supply line as shown in fig. 7. Place sediment trap where it is within reach for cleaning. Locate sediment trap where trapped matter is not likely to freeze. A sediment trap traps moisture and contaminants. This keeps them from going into heater controls. If sediment trap is not installed or is installed incorrectly, heater may not run properly.

IMPORTANT: hold the pressure regulator with wrench when connecting it to gas piping and/or fittings. Do not over tighten pipe connection to regulator. The regulator body could be damaged.

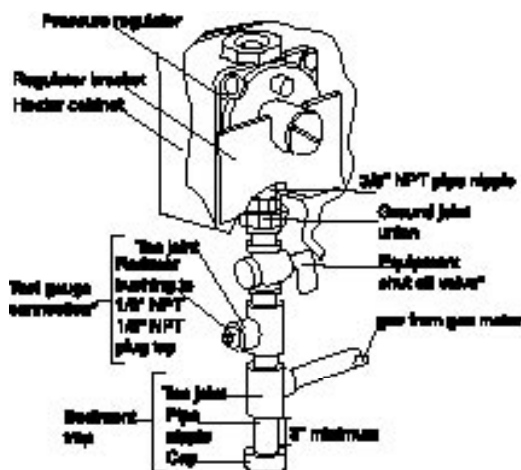

fig. 7

CHECKING GAS CONNECTIONS

WARNING: test all gas piping and connections for leaks after installing or servicing . Correct all leaks at once.

WARNING: never use an open flame to check for a leak. Apply a non-corrosive leak detection fluid to all joints. Bubbles forming show a leak. Correct all leaks at once.

CAUTION: For propane/LP gas, make sure external regulator has been installed between propane/LP supply and heater. See guidelines under connecting to Gas Supply, page 8.

The appliance and its appliance main gas valve must be disconnected from the gas supply piping system during any pressure testing of that system pressures in excess of 1/2 psi (3.5 Kpa).

The appliance must be isolated from the gas supply piping system by closing its equipment shut-off valve during any pressure testing of the gas supply piping system at test pressure equal to or less than 1/2 psi (3,5 kpa).

1. Disconnect appliance with its appliances main gas valve (control valve) and equipment shutoff valve from gas supply piping system. Pressures in excess of 1/2 psig will damage heater regulator.
2. Cap off open end of gas pipe where equipment shutoff valve was connected.
3. Pressurize supply piping system by either opening propane/LP supply tank valve for propane/LP gas or opening main gas valve located on or near gas meter for natural gas, or using compressed air.
4. Check all joints of gas supply piping system. Apply a non-corrosive leak detection fluid to all joints. Bubbles forming show a leak.
5. Correct all leaks at once.
6. Reconnect heater and equipment shutoff valve to gas supply. Check reconnected fittings for leaks.

* A CSA design-certified equipment shutoff valve with 1/8" NPT tap is an acceptable alternative to test gauge connection. Purchase the optional CSA design certified shutoff valve from your dealer.

Test pressures equal or less than 1/2 PSIG (3,5 Kpa)

1. Close equipment shutoff valve (see figure 8).
2. Pressurize supply piping system by either opening propane/LP supply tank valve located on or near gas meter for natural gas, or using compressed air.
3. Check all joints from gas meter for natural gas (see figure B) or propane/LP supply tank for propane /LP gas, to equipment shutoff valve (see figure C). Apply a non-corrosive leak detection fluid to all joints. Bubbles forming show a leak.
4. Correct all leaks at once.

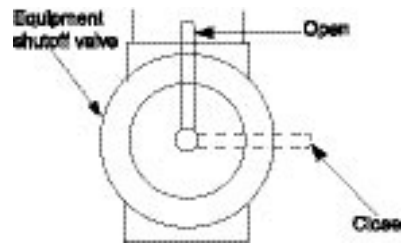

Fig.8 Equipment Shutoff Valve

PRESSURE TESTING HEATER GAS CONNECTIONS

1. Open equipment shutoff valve (see figure A).
2. For natural gas open main gas valve located on or near gas meter. For propane/LP gas open propane /LP supply tank valve.
3. Make sure control knob of heater is in the OFF position.
4. Check all joints from equipment shutoff valve thermostat gas valve (see figure 8/9 or 10). Apply a non-corrosive leak detection fluid to all joints. Bubbles forming show a leak.
5. Correct all leaks at once.
6. Light heater (see operating heater, page 11). Check all other internal joints for leaks.
7. Turn off heater (see to turn off gas to appliance, page 12)

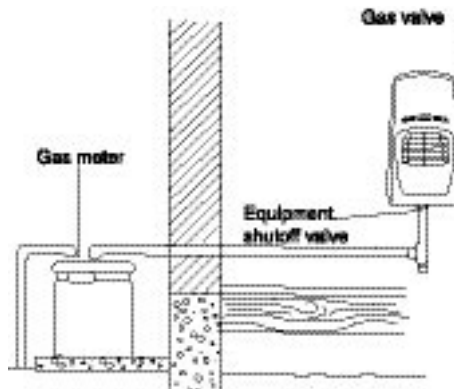

Fig.9 Checking Gas Joints for Natural Gas

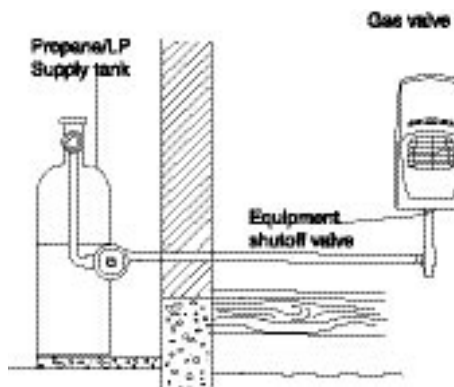

Fig.10 Checking Gas Joints for Propane/LP Gas

OPERATING HEATER

FOR YOUR SAFETY
READ BEFORE LIGHTING

WARNING: if you do not follow these instructions exactly, a fire or explosion may result causing property damage, personal injury or loss of life.

- A. This appliance has a pilot which must be lighted by hand. When lighting the pilot, follow these instructions exactly.
- B. Before lighting smell all around the appliance area for gas. Be sure to smell next to the floor because some gas is heavier than air and will settle on the floor.

WHAT TO DO IF YOU SMELL GAS.

- Do not try to light any appliance.
 - Do not touch any electric switch; do not use any phone in your building.
 - Immediately call your gas supplier from a neighbor's phone. Follow the gas supplier's instruction.
 - If you cannot reach your gas supplier, call the fire department.
- C. Use only your hand to push in or turn the gas control knob. Never use tools. If the knob will not push in or turn by hand, don't try to repair it, call a qualified service technician or gas supplier. Force or attempted repair may result in a fire or explosion.
 - D. Do not use this appliance if any part has been under water. Immediately call a qualified service technician to inspect the appliance and to replace any part of the control system and any gas control which has been under water.

LIGHTING INSTRUCTION

1. STOP! Read the safety information above.
2. Make sure equipment shutoff valve is fully open.
3. Turn thermostat control knob clockwise  to the OFF position (see fig. 11).
4. Wait five minutes to clear out any gas. Then smell for gas, including near the

floor. If you smell gas, STOP! Follow the safety information. If you don't smell gas, go to the next step.

5. Turn thermostat control knob counterclockwise  to the pilot position. Press in thermostat control knob for 5 seconds (see fig. 11).

Note: you may be running this heater for the first time after hooking up to gas supply. If so, you may need to press in control knob for 30 seconds or more. This will allow air to bleed from the gas system.

- If thermostat control knob does not pop up when released, contact a qualified service person or gas supplier for repairs.
6. Keep thermostat control knob pressed in while pushing down and releasing the ignitor button. This will light pilot. If necessary, continue to press ignitor button until pilot lights.

If pilot does not light:

- turn thermostat control knob clockwise  to the OFF position.
 - repeat step 5 and 6.
- If pilot does not stay lit after several tries:
- refer to troubleshooting, pages 16 through 18.
 - contact a qualified service person or a gas supplier for repairs.
7. Keep thermostat control knob pressed in for 30 seconds after lighting pilot. After 30 seconds, release control knob.

Note: If pilot goes out, repeat steps 3 through 7.

8. Turn thermostat control knob counterclockwise  to the desired heating level. The main burner should light. Set control knob to any heat level between HI and LOW (see fig. 12).

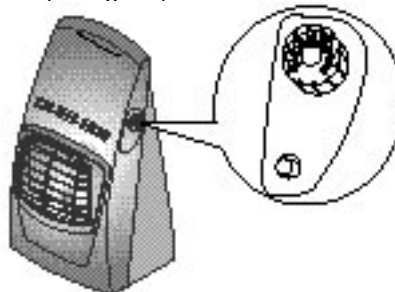

Fig.11 Control Knob

TO SELECT HEATING LEVEL

CAUTION: Do not try to adjust heating levels by using the equipment shutoff valve.

The thermostatic control used on this model turn on and off the burner. The thermostat used on this heater senses the room temperature. At times the room may exceed the set temperature. If so, the burner will shut off. The burner will cycle back on when room temperature drops below the set temperature. The control knob can be set to any 2 comfort level between HI and LOW. All plaques will turn off and on.

Note: The thermostat sensing bulb measures the temperature of air near the heater cabinet. This may not always agree with room temperature (depending on housing construction, installation location, room size, open air temperatures, etc.) Frequent use of your heater will let you determine your own comfort levels.

Control Knob

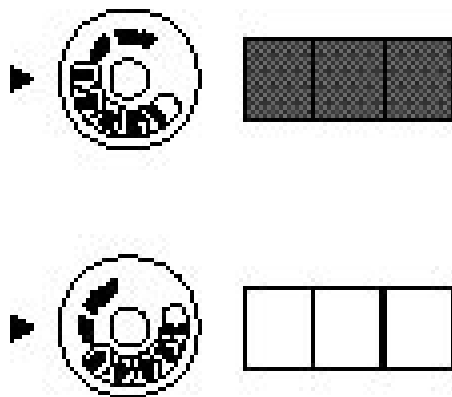



Fig.12 Burner Patterns

TO TURN OFF GAS TO APPLI- ANCE

Shutting off burner only (pilot stays lit)

Turn thermostat control knob clockwise  to the PILOT position.

Shutting off heater

Turn thermostat control knob clockwise  to the OFF position.

INSPECTING HEATER

Check pilot flame pattern and burner flame pattern often.

PILOT FLAME PATTERN

Figure shows a correct pilot flame pattern. Figure 13 shows an incorrect pilot flame pattern. The incorrect pilot flame is not touching the thermocouple. This will cause the thermocouple to cool. When the thermocouple cools, the heater will shut down.

If pilot flame pattern is incorrect, as shown in figure 14.

- turn heater off (see above, to turn off the gas to appliance)
- see troubleshooting, pages 16 through 18

Note: the pilot flame on natural gas units will have a slight curve, but flame should be blue and have no yellow or orange color.

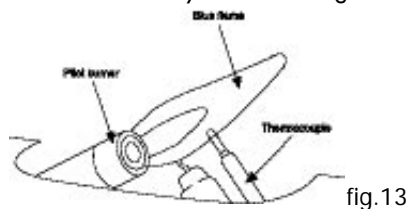

fig.13

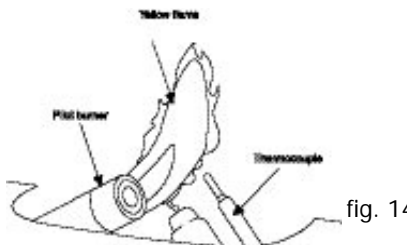
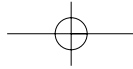

fig. 14



BURNER FLAME PATTERN

Figure 15 shows a correct burner flame pattern. Figure 16 shows a incorrect burner flame pattern.

If burner flame pattern is incorrect, as shown in figure 16

- turn heater off (see to turn off gas to appliance, page 12)
- see troubleshooting, pages 16 through 18

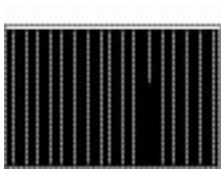

fig. 15

correct burner

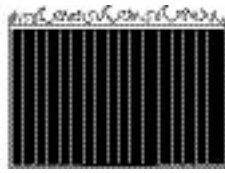
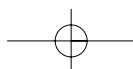
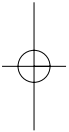

fig. 16

incorrect burner



CLEANING AND MAINTENANCE

WARNING: Turn off heater and let cool before cleaning

CAUTION: you must keep control areas, burner, and circulating air passageways of heater clean. Do not close this zone. Inspect these areas of heater before each use. Have heater inspected yearly by a qualified service person. Heater may need more frequent cleaning due to excessive lint from carpeting, bedding material, pet hair, etc.

ODS/PILOT AND BURNER

- Use a vacuum cleaner, pressurized air, or small, soft bristled brush to clean.

CLEANING BURNER PILOT AIR INLET

The primary air inlet holes allow the proper amount of air to mix with the gas. This provides clean burning flame. Keep these holes clear of dust, dirt, and lint. Clean these air inlet holes prior to each heating season. Blocked air holes will create soot. We recommend that you clean the unit every three months during operation and have heater inspected yearly by a qualified service person.

We also recommend that you keep the burner tube and pilot assembly clean and free of dust and dirt. To clean these parts we recommend using compressed air no greater than 30 PSI. Your local computer store, hardware store, or home center may carry composition. If using compressed air in a can, please follow the directions on the can. If you don't follow directions on the can, you could damage the pilot assembly.

1. Shut off the unit, including the pilot. Allow the unit to cool for at least thirty minutes.
2. Inspect burner, pilot for dust and dirt.
3. Blow air through the ports/slots and holes in the burner.
4. Never insert objects into the pilot tube.

Clean the pilot assembly also. A yellow tip on the pilot flame indicates dust and dirt in the pilot assembly (see figure 14). With the

unit off, lightly blow air through the air inlet. You may blow through a drinking straw if compressed air is not available.

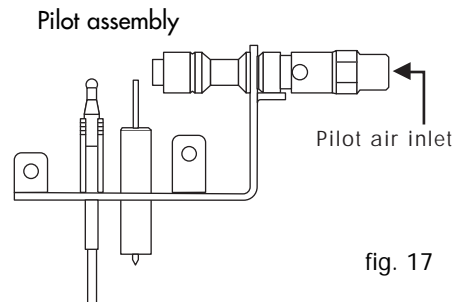

CABINET

Air passageways

- Use a vacuum cleaner or pressurized air to clean.

Exterior

- Use a soft cloth dampened with a mild soap and water mixture. Wipe the cabinet to remove dust.

SPECIFICATION

This heater is equipped with an oxygen depletion safety system and safety shut-off system.

Heater ratings in british thermal units per hour (BTUH)

Model	Model Setting	Input (BTUH)	Type gas	Pressure regulator setting	Orifice Drill size	n° of radiators	Inlet gas pressure (inches of water)	
							MAX	MIN
LP GAS	pilot	400	L.P.*	8"	0,95	3	13"	11"
	ON	13660						
NAT GAS	pilot	1000	NATURAL	6"	1,25	3	10,5"	3,5"
	ON	13660						

for elevations above 2000 feet reduce rating 4% for each 1000 feet above sea level.

* L.P.- Liquefied Petroleum

APPLIANCE DIMENSIONS

Width: 15.75 inches
Height: 29.14 inches
Depth: 9.65 inches

PACKAGING DIMENSIONS

Width: 18.7 inches
Height: 31.3 inches
Depth: 11.8 inches

REPLACEMENT PARTS

Note: use only original replacement parts. This will protect your warranty coverage for parts replaced under warranty.

PARTS UNDER WARRANTY

Contact an authorized dealer from whom you purchased this product. If they are unable to supply original replacement part(s), call De'Longhi Usa . When contacting your dealer, have ready:

- your name
- your adress
- model and serial numbers of your heater
- how heater was malfunctioning
- Type of gas used (natural gas)
- purchase date

Usually, we will ask you to return the defective part to the factory

PARTS NOT UNDER WARRANTY

Contact authorized dealers of this product.

TECHNICAL SERVICE

You may have further questions about installation, operation, or troubleshooting. If so, contact De'Longhi Usa toll-free number 1-800-322-3848

TROUBLESHOOTING

WARNING: if you smell gas

- Shut off gas supply
- Do not try to light any appliance
- Do not touch any electrical switch; do not use any phone in your building
- Immediately call your gas supplier from a neighbor's phone. Follow the gas supplier's instructions
- If you cannot reach your gas supplier, call the fire department.

IMPORTANT: Operating heater where impurities in air exist may create odors. Cleaning supplies, paint, paint remover, cigarette smoke, cements and glues, new carpet or textiles, etc., create fumes. These fumes may mix with combustion air and create odors.

Note: All troubleshooting items are listed in order of operation

WARNING: only a qualified service person should service and repair heater

CAUTION: never use wire, needle, or similar object to clean ODS/pilot. This can damage ODS/pilot unit

OBSERVED PROBLEM	POSSIBLE CAUSE	REMEDY
Heater produces unwanted odors	<ol style="list-style-type: none"> 1. Heater burning vapors from paint, hair spray, glues, etc. See important statement above 2. Gas leak. See warning statement at top of page 	<ol style="list-style-type: none"> 1. Ventilate room. Stop using odor causing products while heater is running 2. Locate and correct all leaks (see checking gas connections, page)
Heater shuts off in use	<ol style="list-style-type: none"> 1. Not enough fresh air is available 2. Burner orifice is clogged 	<ol style="list-style-type: none"> 1. Contact local natural gas company 2. Clean burner orifice (see cleaning and maintenance, pag 14) or replace the burner.
Burner backfiring during combustion	<ol style="list-style-type: none"> 1. Burner orifice is clogged or damaged 2. Low line pressure 3. Ods/pilot is partially clogged 	<ol style="list-style-type: none"> 1. Open window and/or door for ventilation 2. Contact local natural gas company 3. Clean ODS/pilot (see cleaning and maintenace page)
Gas odor even when control knob is in OFF position	<ol style="list-style-type: none"> 1. Gas leak. See warning statement at top of page 2. Thermostat control valve defective 	<ol style="list-style-type: none"> 1. Locate and correct all leaks (see checking gas connections, page 9) 2. Replace thermostat control valve
Gas odor during combustion	<ol style="list-style-type: none"> 1. Foreign matter between control valve and burner 2. Gas leak. See warning statement at top of page 	<ol style="list-style-type: none"> 1. Take apart gas tubing and remove foreign matter 2. Locate and correct all leaks (see checking gas connections, page 9)
Heater produces a clicking/ticking noise just after burner is lit or shut off	<ol style="list-style-type: none"> 1. Metal expanding while heating or contracting while cooling 	<ol style="list-style-type: none"> 1. This is common with most heaters. If noise is excessive, contact qualified service person
Moisture/condensation noticed on windows	<ol style="list-style-type: none"> 1. Not enough combustion/ventilation air 	<ol style="list-style-type: none"> 1. Refer to fresh air for combustion and ventilation, page 4

TROUBLESHOOTING

Note: All troubleshooting items are listed in order of operation

WARNING: only a qualified service person should service and repair heater

CAUTION: never use wire, needle, or similar object to clean ODS/pilot. This can damage ODS/pilot unit

OBSERVED PROBLEM	POSSIBLE CAUSE	REMEDY
When ignitor button is pressed in, there is no spark at ODS/pilot	<ol style="list-style-type: none"> 1. Ignitor electrode positioned wrong 2. Ignitor electrode broken 3. Ignitor electrode not connected to ignitor cable 4. Ignitor cable pinched or wet 5. Broken ignitor cable 6. Bad piezo ignitor 	<ol style="list-style-type: none"> 1. Replace ignitor 2. Replace ignitor 3. Reconnect ignitor cable 4. Free ignitor cable if pinched by any metal or tubing. Keep ignitor cable dry 5. Replace piezo ignitor 6. Replace piezo ignitor
ODS/pilot lights but flame goes out when control knob is released.	<ol style="list-style-type: none"> 1. Gas supply turned off or equipment shutoff valve closed 2. Control knob not fully pressed in while pressing ignitor button 3. Air in gas lines when installed 4. ODS/pilot is clogged 5. Gas regulator setting is not correct 6. Control knob not in pilot position 	<ol style="list-style-type: none"> 1. Turn on gas supply or open equipment shutoff valve 2. Fully press in control knob while pressing ignitor button 3. Continue holding down control knob. Repeat igniting operation until air is removed 4. Clean ODS/pilot (see cleaning and maintenance, page 14 or replace ODS/pilot assembly) 5. Replace gas regulator 6. Turn control knob to pilot position
When ignitor button is pressed in, there is a spark at ODS/pilot but no igniton	<ol style="list-style-type: none"> 1. Control knob not fully pressed in 2. Control knob not pressed in long enough 3. Equipment shutoff valve not fully open 4. Thermocouple connection loose at control valve 5. Pilot flame not touching thermocouple, which, allows thermocouple to cool, causing pilot flame to go out. This problem could be caused by one or both of the following: A) Low gas pressure B) Dirty or partially clogged ODS/pilot 6. Thermocouple damaged 7. Control valve damaged 	<ol style="list-style-type: none"> 1. Press in control knob fully 2. After ODS/Pilot light, keep control knob pressed in 30 seconds 3. Fully open equipment shutoff valve 4. Hand-tighten until snug, then tight 1/4 turn more 5. A) Contact local natural gas company B) Clean ODS/Pilot (see cleaning and maintenance, page 14) or replace ODS/Pilot assembly) 6. Replace ODS/Pilot 7. Replace thermostat control valve

Note: All troubleshooting items are listed in order of operation

WARNING: only a qualified service person should service and repair heater

CAUTION: never use wire, needle, or similar object to clean ODS/pilot. This can damage ODS/pilot unit

OBSERVED PROBLEM	POSSIBLE CAUSE	REMEDY
Burner does not light after ODS/pilot is lit	<ol style="list-style-type: none"> 1. Burner orifice is clogged 2. Inlet gas pressure is too low 	<ol style="list-style-type: none"> 1. Clean burner orifice (see cleaning and maintenance, pag 14) or replace the burner 2. Contact local natural gas company
Delayed ignition of burner	<ol style="list-style-type: none"> 1. Manifold pressure is too low 2. Burner orifice is clogged 	<ol style="list-style-type: none"> 1. Contact local natural gas company 2. Clean burner orifice (see cleaning and maintenance, pag 14) or replace the burner
Burner backfiring during combustion	<ol style="list-style-type: none"> 1. Burner orifice is clogged or damaged 2. Burner damaged 3. Gas regulator defective 	<ol style="list-style-type: none"> 1. Clean burner orifice (see cleaning and maintenance, pag 14) or replace the burner 2. Replace burner 3. Replace gas regulator
Burner plaque(s) does not glow	<ol style="list-style-type: none"> 1. Plaque damaged 2. Control knob set between locked positions 3. Inlet gas pressure is too low 	<ol style="list-style-type: none"> 1. Replace burner 2. Turn control knob until it locks at desired setting 3. Contact local natural gas company
Slight smoke or odor during initial operation	<ol style="list-style-type: none"> 1. Residues from manufacturing processes 	<ol style="list-style-type: none"> 1. Problem will stop after a few hours of operation
Heater produces whistling noise when burner is lit	<ol style="list-style-type: none"> 1. turning control knob to HIGH position when burner is cold 2. Air in gas line 3. Air passageways on heater blocked 4. Dirty or partially clogged burner orifice 	<ol style="list-style-type: none"> 1. Turn control knob to LOW position and let warm up for a minute 2. Operate burner until air is removed from line. Have gas line checked by local natural gas company 3. Observe minimum installation clearances (see figure 4, page 7) 4. Clean burner (see cleaning and maintenance, page 14) or replace the burner
White powder residue forming with burner box or on adjacent walls or furniture	<ol style="list-style-type: none"> 1. When heated, vapors from furniture polish, wax, carpet cleaners, etc., turn into white powder residue 	<ol style="list-style-type: none"> 1. Turn heater off when using furniture polish, wax, carpet cleaner or similar products



Limited Warranty

What Does This Warranty Cover? We warrant each appliance to be free from defects in material and workmanship. Our obligation under this warranty is limited to replacement or repair, free of charge at our factory or authorized service centers, of any defective part or parts there of other than parts damaged in transit, which shall be returned to us, transportation prepaid. PLEASE BE ADVISED THAT ANY SHIPPING COST FOR REPLACEMENT ITEMS WILL BE CHARGED TO THE CONSUMER. This warranty shall apply only if the appliance is used in accordance with the factory directions which accompany it, and on an Alternating Current (AC) circuit.

How Long Does The Coverage Last? This warranty runs for one year from the date of delivery and applies only to the original purchaser for use.

What Does This Warranty Not Cover? This warranty does not cover defects or damage of the appliance which result from repairs or alterations to the machine outside our factory or authorized service centers, nor shall it apply to any appliance which has been subject to abuse, misuse, negligence or accidents. Also, consequential and incidental damages resulting from the use of this product or arising out of any breach of contract or breach of this warranty are not recoverable under this warranty. Some states do not allow the exclusion or limitation of incidental or consequential damages, so the above limitation may not apply to you.

How Do You Get Service? If repairs become necessary or spare parts are needed, please write to:

De'Longhi America Inc.
Park 80 West Plaza One 4th floor
Saddle Brook, NJ 07663
or call Service Tel. No. 1-800-322-3848

De' Longhi CANADA
6150Mc Laughlin Road
Mississauga, ON
L5R 4E1

The above warranty is in lieu of all other express warranties and representations; All implied warranties are limited to the applicable warranty period set forth above. This limitation does apply if you enter into an extended warranty with De'Longhi. Some states do not allow limitations on how long an implied warranty lasts, so the above exclusions may not apply to you. De' Longhi does not authorize any other person or company to assume for it any liability in connection with the sale or use of its appliance.

How Does State Law Apply? This warranty gives you specific legal rights, and you may also have other rights which vary from state to state.