

STEPS - MANUAL

Transfer function, distortion measurement
Maximum linear displacement
Distortion-limited maximum SPL

Based on the original STEPS Manuals

Original tutorial in German by Dr Heinrich Weber

Original manuals in English prepared by Dr Ivo Mateljan

© Weber/Mateljan

Translation into English of Version 2.40D (ARTA 1.80)

Christopher J. Dunn, Hamilton, New Zealand, September 2014

Contents

1. Introduction to STEPS	3
1.1. Installation requirements.....	3
1.2. Equipment	3
1.3. Pin assignment for cables and connectors.....	4
2. Calibrating STEPS	6
3. Measuring with STEPS	6
3.1. Setting up in STEPS.....	7
3.2. Frequency response and distortion measurements with STEPS	9
3.2.1. Factors influencing distortion measurements.....	10
3.3. Voltage- or power-related measurements with STEPS	15
3.4. Measuring maximum linear cone displacement with STEPS	18
3.5. Measuring THD-limited maximum SPL with STEPS	20
4. References.....	28

Foreword

Because of the increasing scope and complexity of the ARTA Handbook, this guide is now presented separately to those for the other programs in the ARTA family.

STEPS is a program for measuring transfer functions and distortion in loudspeakers and audio equipment. STEPS also provides tools for specialised measurements, including maximum linear displacement in accordance with IEC 62458, and distortion-limited maximum SPL.

This handbook aims to familiarise users with the STEPS part of the ARTA family of programs. It is not, however, intended to be a substitute for the original user manual, with which the reader should familiarise him or herself.

Further information can be found on the ARTA website, which contains the most up-to-date releases and application notes. Although we aim to continue to supplement and update this handbook in line with the continuing development of the ARTA software, we would ask for your patience with any discrepancies that may arise from time to time. Suggestions for improvements and corrections are always welcome.

1. Introduction to STEPS

1.1. Installation requirements

To use the ARTA suite of programs you will need:

- Operating system: Windows 98/ME/2000/XP/VISTA/Windows 7/Windows 8;
- Processor: Pentium 400MHz or higher, memory 128k;
- Soundcard: full duplex.

Installation is very simple. Copy the files to a directory and unzip them. That's it! All registry entries are automatically saved at first start-up.

1.2. Equipment

The following is a brief summary of the equipment required accompanied by some basic directions and cross-referenced to more detailed information elsewhere.

Soundcards

There are three types of soundcard:

- Standard onboard soundcard, found typically on a computer motherboard;
- Plug-in cards for PCI or ISA bus;
- Soundcards connected via USB or firewire.

Essentially, all three types are suitable for use with STEPS if they have an output channel (Line Out) and two input channels (Line In). Note however that onboard sound cards fitted to laptop computers often have a single (mono) channel only, identified as the microphone input (Mic In).

Amplifier

A power amplifier with linear frequency response and power 5–10 watts is adequate. The output impedance should be <0.05 Ohms. An inexpensive solution that meets these requirements and is small and easily portable is the Thomann t.amp PM40C (see also ARTA-Handbook Section 5.4).

For the measurement of linear displacement (Section 3.4), or distortion-limited maximum SPL measurement (Section 3.5) you will need something more powerful. Depending on whether hi-fi or PA speakers are being tested, an output of 200 watts or more may be required.

ARTA Measuring Box

The ARTA Measuring Box is not absolutely necessary, but it does make life a lot easier. When switching between acoustic and electric measurements, the annoyance of having to swap multiple cables is replaced by the simple flick of a switch (see ARTA Application Note 1 (1)).

Multimeter

A multimeter for use with STEPS is not strictly necessary, but it is nevertheless indispensable for the calibration of the measurement equipment to be used. Besides, a good meter is a useful tool for all manner of other measurements. If you do not have a multimeter, you should ideally opt for a 'true RMS' type. There are plenty of options on the market for well below €100.

Cables

Several cables are required, all of which should be of good quality. Poor connections, inadequate shielding, etc. can interfere with measurements (see also ARTA Handbook Section 6.1.1). Keep all cables as short as possible.

1.3. Pin assignment for cables and connectors

Unbalanced	Balanced
	
	
	
	
	
<p>STEREO JACK Sleeve: earth (GROUND/SHIELD) Tip: + Ring: -</p>	<p>XLR Pin 1: earth (GROUND/ SHIELD) Pin 2: + Pin 3: -</p>

Figure 1.3.1 Pin assignment for connecting cables.

2. Calibrating STEPS

The calibration of STEPS is no different to the calibration of ARTA (see the ARTA Handbook). Features specific to STEPS (e.g. maximum displacement and distortion-limited maximum SPL) are covered in the relevant sections of this document.

3. Measuring with STEPS

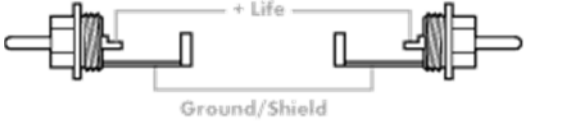
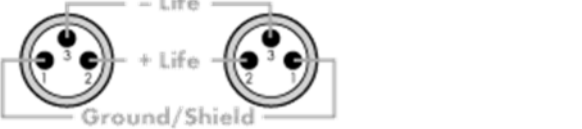
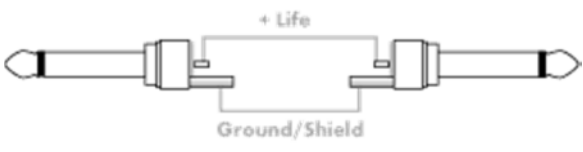
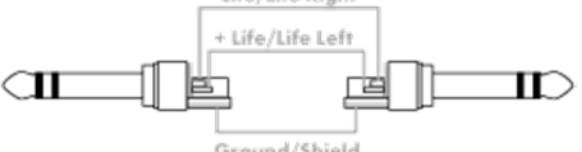
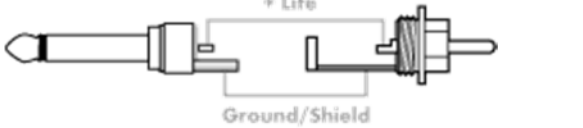
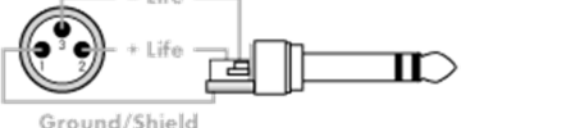
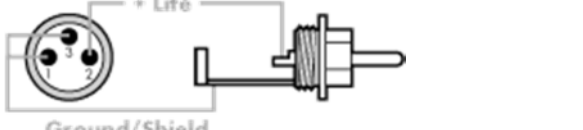
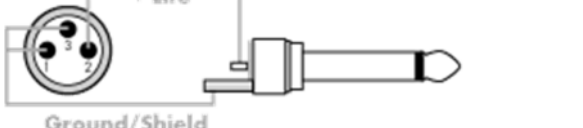
STEPS measures the frequency response and harmonic distortion of a loudspeaker by using a stepped sine wave. The major commands and operations in STEPS can be found in the top menu bar.

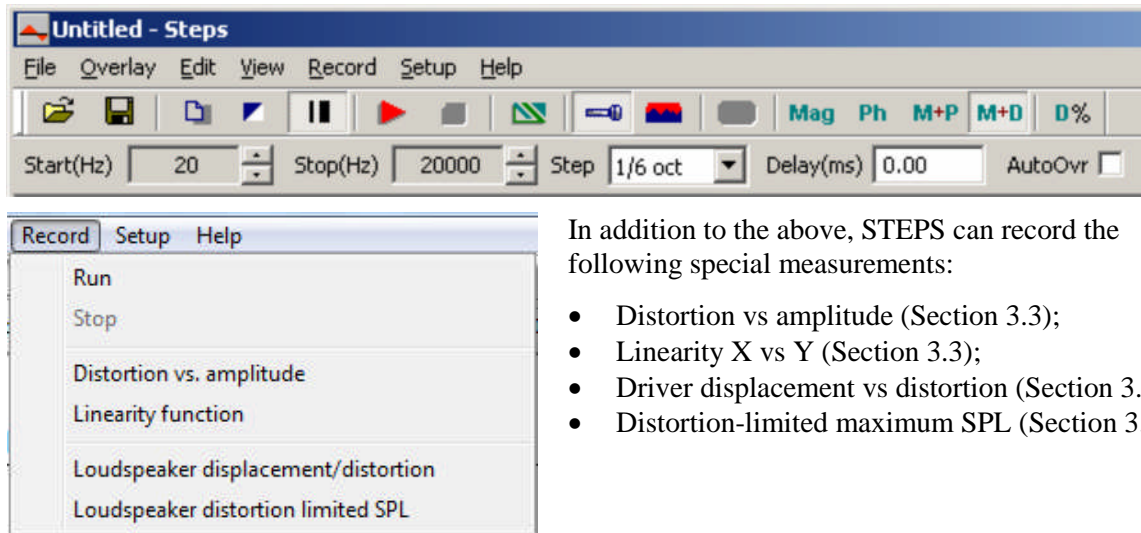

In addition to the above, STEPS can record the following special measurements:

- Distortion vs amplitude (Section 3.3);
- Linearity X vs Y (Section 3.3);
- Driver displacement vs distortion (Section 3.4);
- Distortion-limited maximum SPL (Section 3.5).

When working with STEPS, care should be taken to ensure that the stepped sine excitation signal energy level is sufficient to account for noise. At the same time, output levels should be carefully controlled to protect the DUT and soundcard.

As many of the commands and function in STEPS are the same as those in ARTA, only features specific to STEPS will be discussed in this section.

3.1. Setting up in STEPS

All measurement parameters can be adjusted in 'Measurement setup' (Figure 3.1.1). The menu window is divided into Measurement System and Stepped Sine Generator sections. A meter for setting signal levels is provided at the bottom of the window.

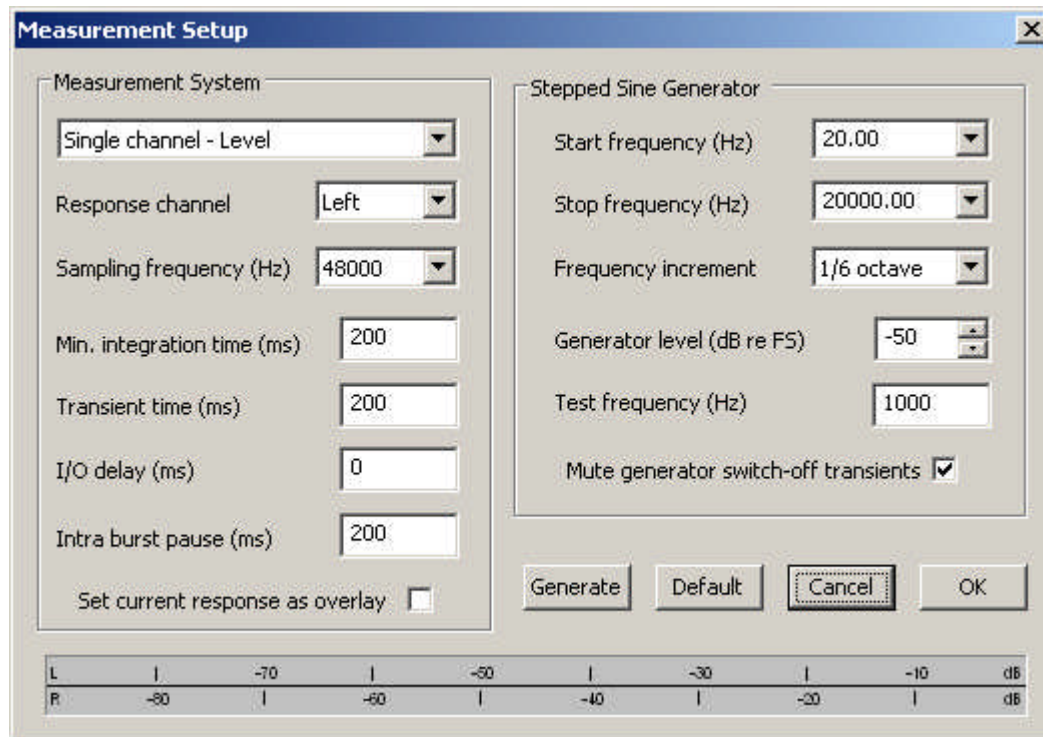

Figure 3.1.1 Measurement setup in STEPS.

The available fields are as follows:

Measurement System

- | | |
|----------------------------|--|
| Measurement Mode | choose single or dual channel measurement from the drop-down menu (see also Section 3.2). |
| Response channel | determines the input channel (default channel = left). |
| Sampling frequency | ranges from 11025Hz to 192kHz. |
| Min. integration time [ms] | STEPS determines the frequency response of the signal from 'I/O Delay' to the beginning of the 'Transient Time' by integrating the sine signal in the time domain. This is termed the 'integration time', and its value depends on the lowest (i.e. start) frequency to be measured. When the lowest frequency to be measured is 'F' Hz, the minimum integration time must be $1/F$ sec. so, for 20Hz, the integration time is $1/20 = 0.05$ sec = 50 ms.

In addition, ARTA and STEPS filter the signal by applying Kaiser windowing, which requires a minimum of five complete cycles (i.e. 250 ms at 20Hz). Faster measurements can be obtained only by increasing the start frequency. |

Note that the integration time relating to the lowest frequency should be doubled when taking distortion measurements (i.e. 500 msec at 20Hz).

Transient time [ms]	the sine signal should be at steady state before measurements start. The time to steady state depends on the resonance behaviour of the system or on acoustic reverberation. For room measurements, the transient time should be at least 1/5 of the reverberation time. For typical rooms, this will be between 100 ms and 200 ms; for outdoor measurements the transient time may be set to 50 ms to 100 ms
I/O delay [ms]	this is the signal delay from the speaker to the microphone ($t = s \cdot c$); it must be accounted for if useful phase responses are to be obtained.
Intra burst pause [ms]	after a measurement has taken place, the system must be allowed to settle before the next measurement begins - this is the intra-burst pause. As a rule of thumb, it may be assumed to be 1/5 of the reverberation time.

Stepped Sine Generator

Start frequency	value of the start frequency in Hz
Stop frequency	value of the stop frequency in Hz.
Generator level	enter the generator output voltage in dB re FS.
Frequency increment	size of frequency step
Mute generator switch-off transients	eliminates clicks at the end of the signal when checked. This prolongs measurement time a little

3.2. Frequency response and distortion measurements with STEPS

STEPS generates frequency response measurements similarly to ARTA. The main difference lies in the excitation signal (see STEPS User Manual) and the duration of the measurement. Depending on the choice of parameters, measurements can take several minutes because of the need to sum the integration time, transient timeline and intra-burst break multiplied by the frequency Increment and the number of octaves swept. Initial trials should therefore be carried out with conservative signal levels and frequency resolution (1/6 octave).

Options available in STEPS include amplitude, phase, amplitude + phase, amplitude + distortion and % distortion.



To see the correct phase relationship the path between the speaker and the microphone should be compensated by a delay. It is difficult to determine the exact value for this parameter because of the difficulty in determining the exact acoustic centre of the speaker (see Section 6.3).

For a reasonable approximation, we can calculate the delay as follows:

$$I/O \text{ delay [msec]} = 1000 \times \text{measuring distance [m]} / \text{speed of sound [m/sec]} \quad c = 344 \text{ m/sec}$$

Thus, for a measured distance of 0.5m from microphone to baffle, the delay would be 1.4534 msec.

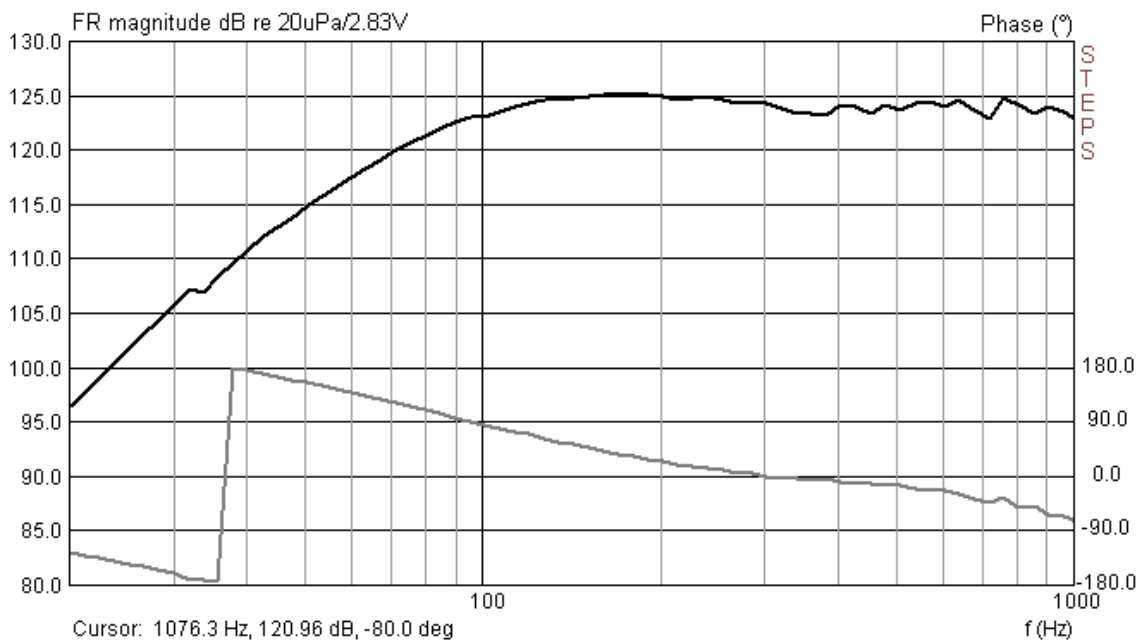

Figure 3.2.1. Frequency response of a 6" TMT measured with STEPS with 1/12 octave resolution

As described earlier, STEPS can perform measurements in single or dual channel mode. Unlike ARTA, however, STEPS shows the absolute current level in single channel mode with no reference.

Thus, if the output voltage of the amplifier is increased or decreased in single channel mode with STEPS, the different frequency response levels can be seen. This is sometimes useful if you want to determine the sound level measured by the microphone that corresponds to a particular amplifier output voltage (Figure 3.2.2).

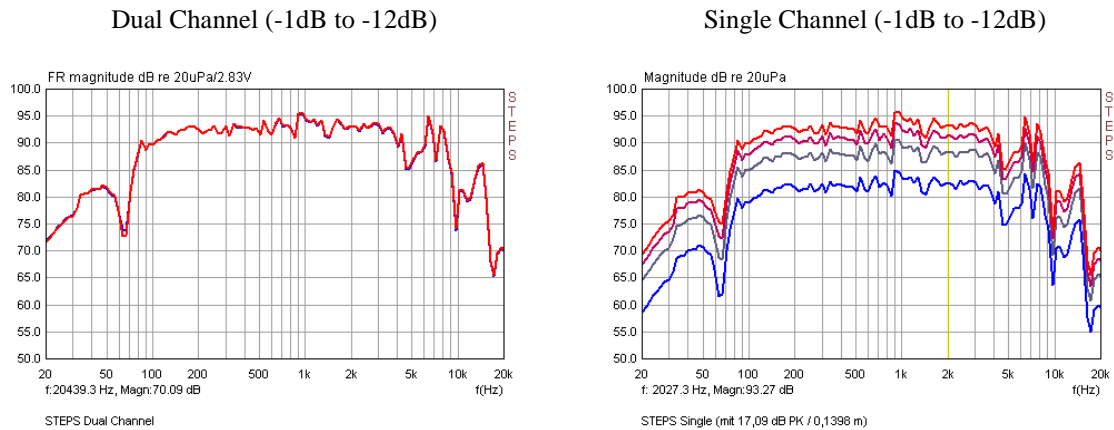

Figure 3.2.2 Frequency amplitude response in dual (left) and single (right) channel modes

Dual channel mode (Figure 3.2.2, left) shows the reference level (dB re 20uPa/2.83V). Any change in the output voltage is back-calculated by STEPS to 2.83 or 1 volt, depending on the choice of units under 'View' and 'Sound Pressure Units'. In single channel mode, absolute changes corresponding to the varying output voltage of the amplifier are displayed (Figure 3.2.2, right).

In addition to frequency response, STEPS is particularly suited to measuring harmonic distortion. Measurements are less prone to noise interference than those taken using the Farina method (Chapter 7.1) but take considerably longer (depending on the settings used).

Different results (dB or %) can be displayed in STEPS by using the buttons on the menu bar.

M+D = Magnitude + Distortion

D% = Distortion %

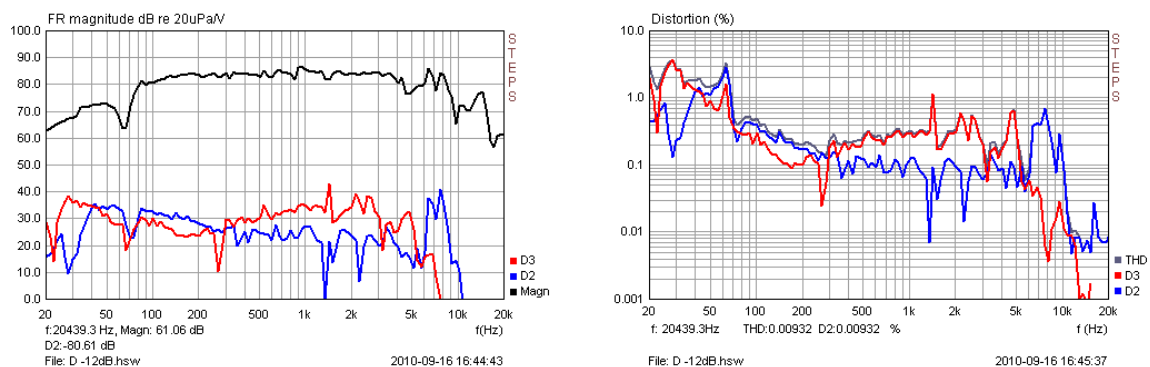

Figure 3.2.3 Distortion measurement display options

3.2.1. Factors influencing distortion measurements

Distortion measurements may be influenced by both the measuring equipment and the environment, with environmental effects increasing with the measurement distance. This will limit the extent to which measurements can be compared and leads to the need for some experimentation with measurement distances in order to gauge levels of interference.

To exclude environmental effects, measurements should be taken under nearfield conditions.

Critical distance $r_H \approx 0,057 \cdot \sqrt{\frac{V}{T_{60}}}$ V = room volume (m³); T₆₀ = reverberation time (sec)

If nearfield measurements are used, care should be taken to ensure that the microphone does not distort. The AES2 specification (2) states that measurements should be carried out at around 10% of the rated power of the speaker; this is typically $\geq 90\text{dB}$ at a distance of 1m. At this level, in a nearfield environment the microphone would register a level of around 120dB, which is enough to drive most inexpensive models beyond recommended limits.

The following example illustrates this point. Three microphones were compared: an inexpensive model (MM-1 T-Bone, costing around € 35), a mid-range model (Audix TM1, around € 300), and a class 1 reference microphone (NTI M2210, cost around € 1100). Figure 3.2.4 compares THD, D2, D3 and D4 traces for the T-Bone and M2210.

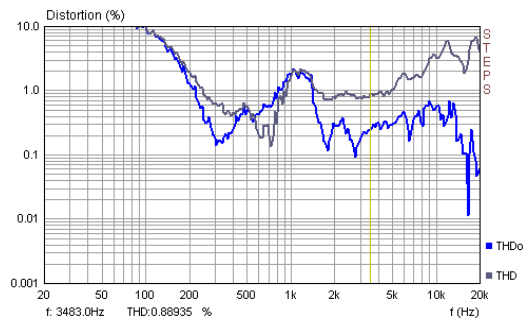

THD: t-Bone (grey)

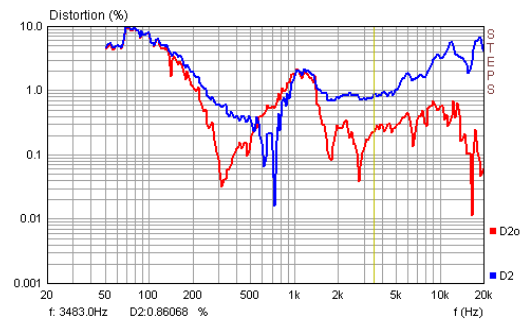

D2: t-Bone (blue)

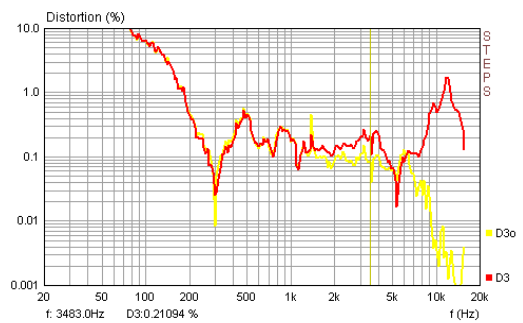

D3: t-Bone (red)

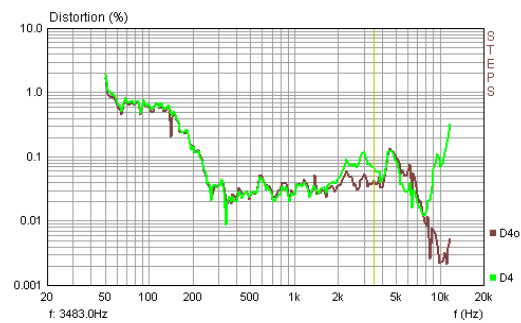

D4: t-Bone (green)

Figure 3.2.4 Comparison of T-Bone MM1 and NTI M2210.

The traces indicate that the T-Bone is not sufficiently accurate for distortion measurements. The Audix TM1, however, is a much better candidate, with responses very similar to those obtained with the reference microphone (Figure 3.2.5).

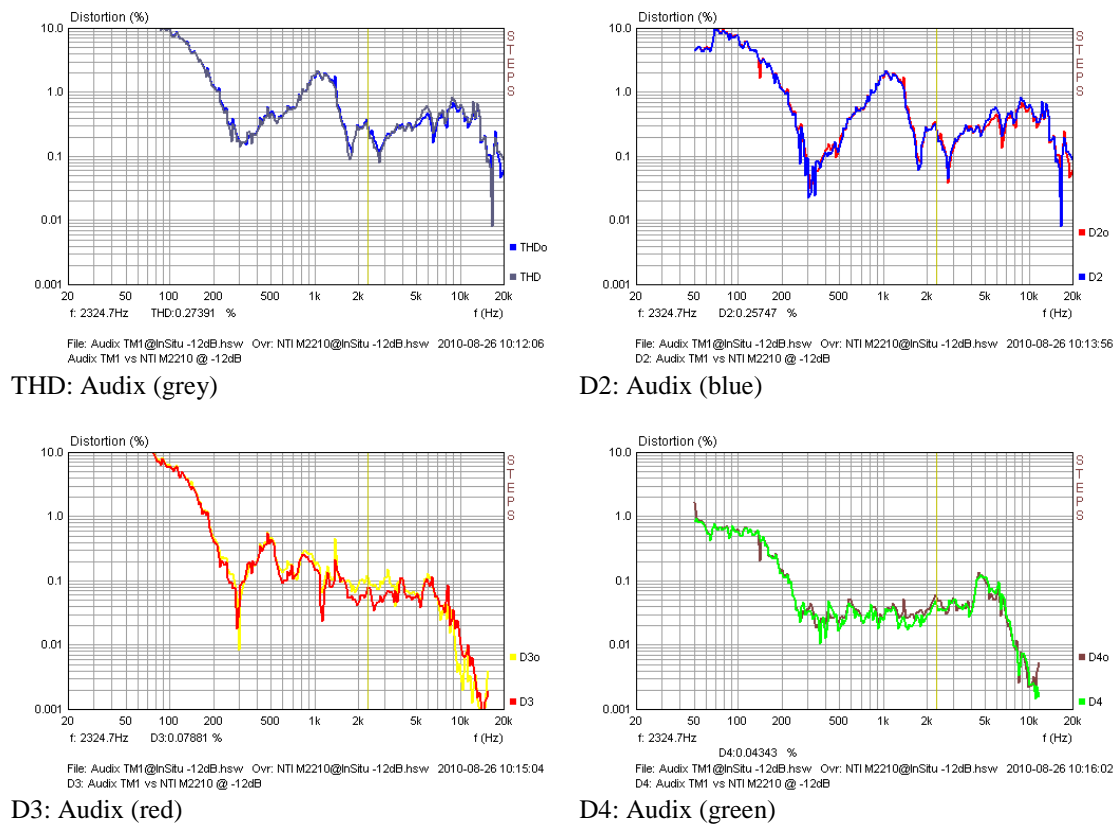

Figure 3.2.5 Comparison of Audix TM1 and NTI M2210.

The comparison demonstrates among other things that the use of cheap equipment is not worthwhile, given the precision required for distortion measurements.

Other factors can also affect results, notably room boundary conditions. Figure 3.2.6 shows distortion measurements in dB and % on a 5" TMT speaker taken under nearfield conditions at 10, 25 and 40cm.

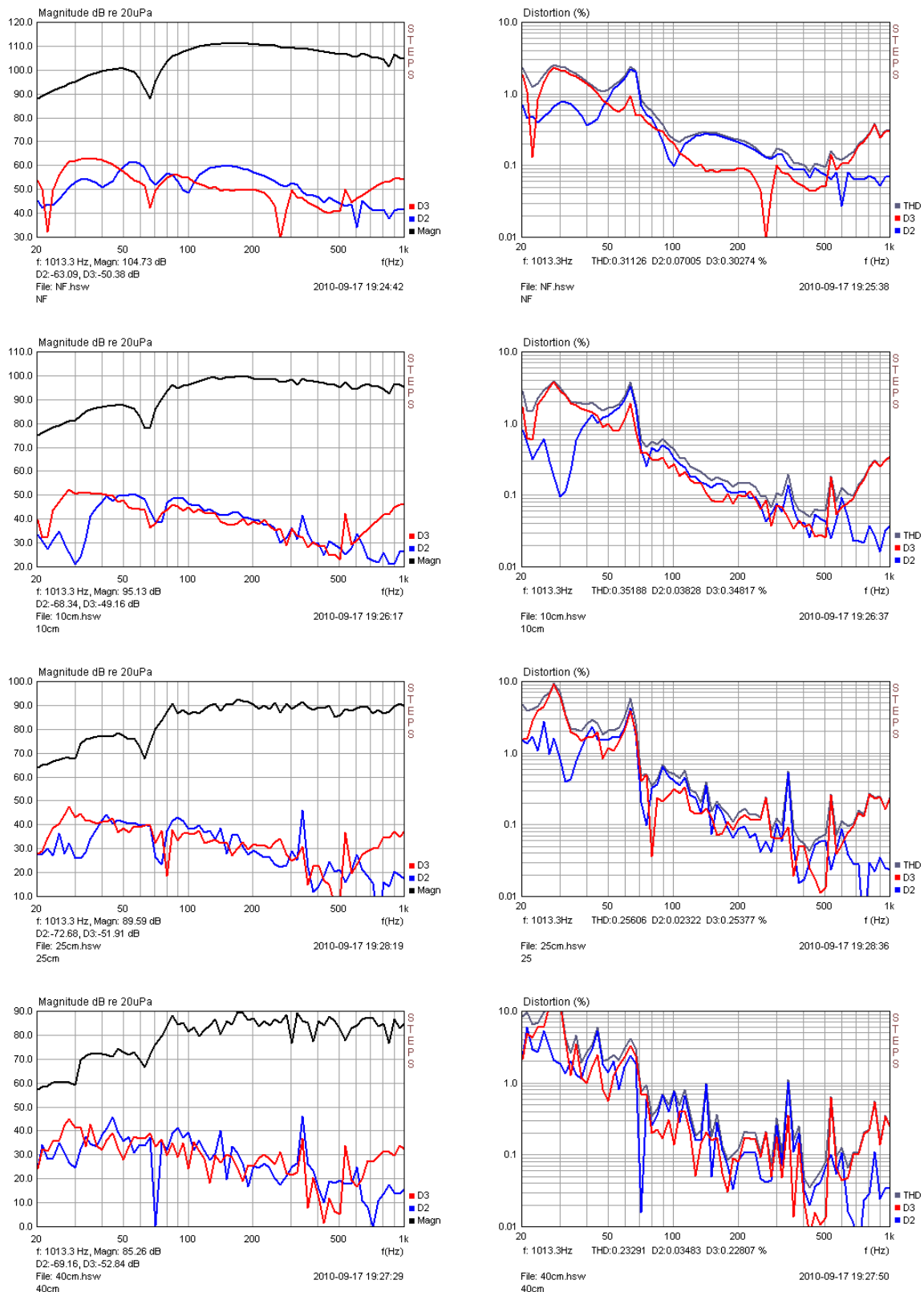
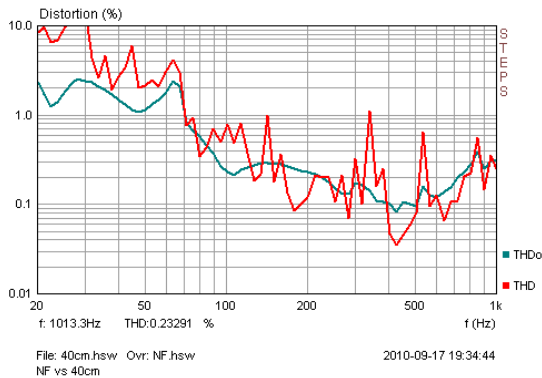
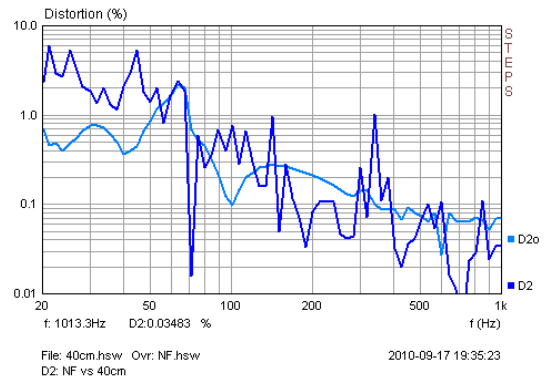

Figure 3.2.6 Distortion (amplitude and %): nearfield and at 10, 25 and 40cm (from top).

With increasing distance, the room influence becomes more noticeable in both frequency and distortion traces. Figure 3.2.7 shows direct comparisons of % distortion traces for nearfield and 40cm measurements. Increasing distance not only makes the traces noisier, but it also contributes to overall apparent distortion.



THD: FF (red), NF (blue)



D2: FF (dark blue), NF (light blue)

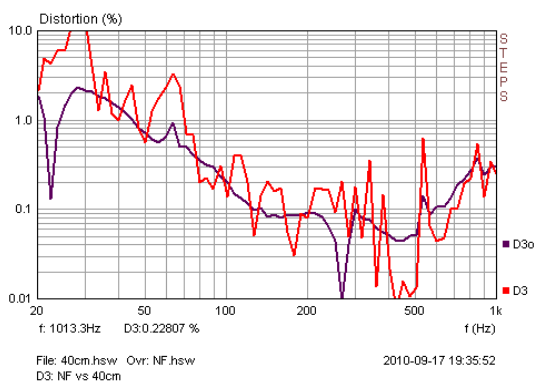

D3: FF (red), NF (dark blue)

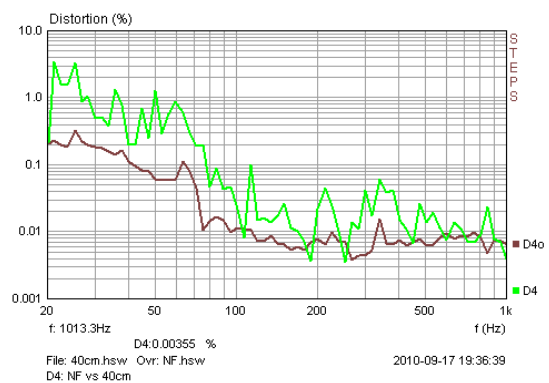

D4: FF (green), NF (brown)

Figure 3.2.7 Distortion traces (%). Comparisons of nearfield and 40cm farfield measurements.

The examples demonstrate the factors to be considered when making reproducible distortion measurements. They include signal and sound pressure levels, the quality of the microphone and its distance from the speaker, and the contribution of room reflections. The measurement setup should account for these factors as much as possible in order to optimise results.

3.3. Voltage- or power-related measurements with STEPS

In addition to the functions described above in Section 3.2, STEPS has four further special functions under the 'Record' menu. These stepped amplitude tests measure system response and distortion as a function of the amplitude of the excitation signal, a sine or two-sine signal with a user-defined frequency. The amplitude of the signal changes from the lowest to the highest value in a predefined number of measurement steps. These tests are primarily intended for power amplifier, audio compressor and automatic gain control systems, and include the following:

- Distortion vs amplitude
- Linearity function
- Loudspeaker displacement/distortion
- Loudspeaker distortion-limited SPL.

The distortion vs amplitude function is used to measure voltage- or power-related distortion in electrical (e.g. amplifier) and electroacoustic (e.g. speaker) systems. Power values must be worked out manually according to $P = V^2/R$, where R is the reference resistance, and may be added to the X axis by hand.

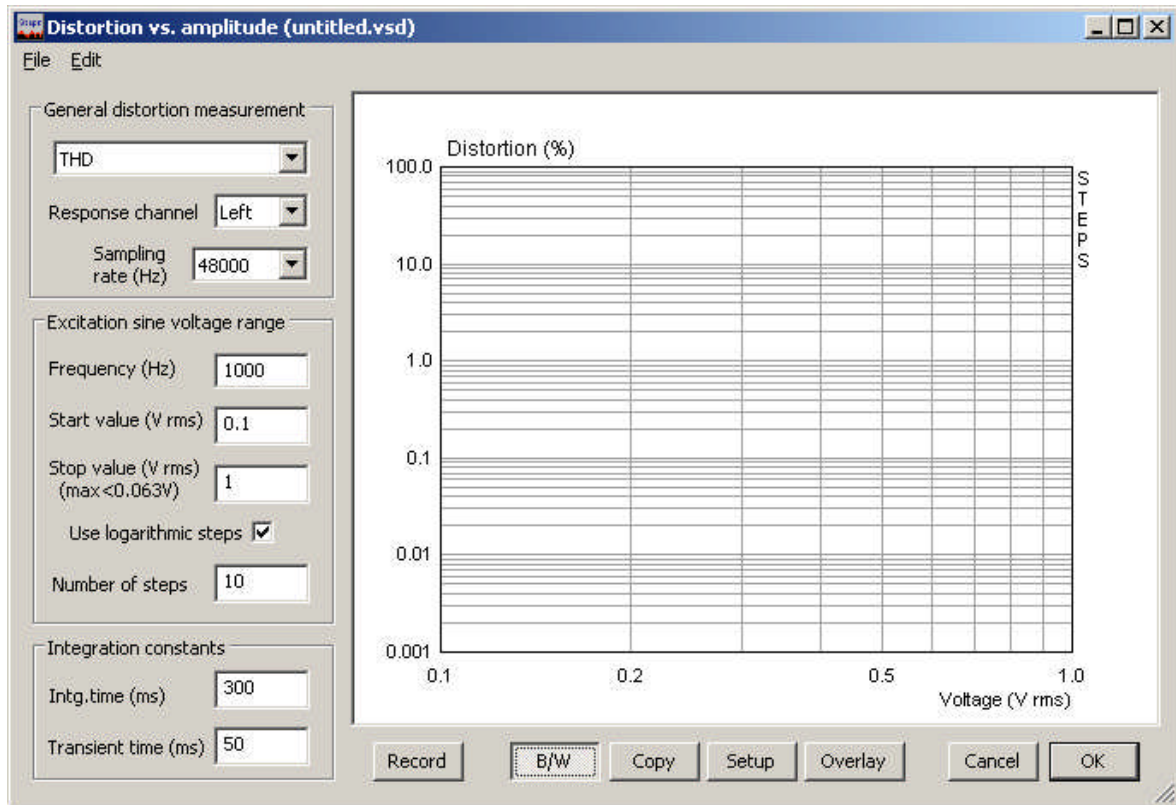
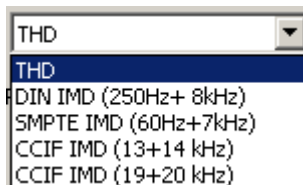

Figure 3.3.1 Distortion vs Amplitude window

The input fields for the measurement parameters are to the left of the window in Figure 3.3.1, while the settings for graphics and overlays are at the bottom. Under 'General Distortion Measurement', different evaluation modes can be selected (THD, IMD DIN, CCIF IMD), together with the input channel and sampling rate. For more information see the STEPS User Manual.



Measurement parameters are set under 'Excitation sine voltage range' (frequency, start and stop values, linear or logarithmic voltage increase, number of steps). The maximum output voltage is recorded in the 'Stop value' field. This is calculated from the gain of the power amplifier with a safety margin to a maximum of 3dB (see also section 3.2). Before measuring, check whether the DUT is likely to be damaged by the voltages that will be applied!

Figure 3.3.2 shows distortion in a small power amplifier at 1kHz as a function of voltage. Notes on measurement and setup can be found in Section 5.4 of the ARTA Handbook.

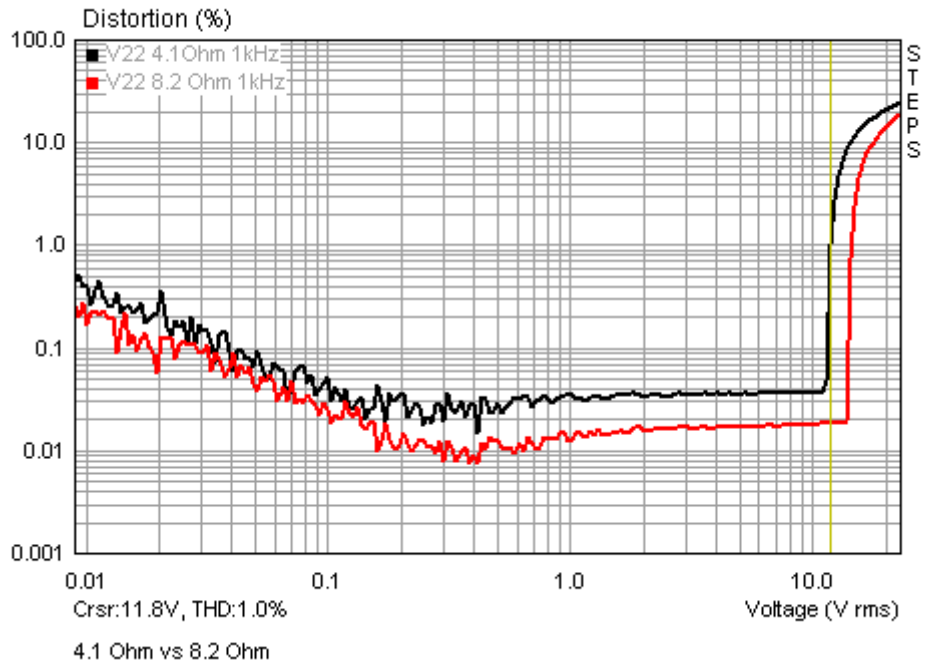

Figure 3.3.2 THD vs voltage @ 1kHz for a small power amplifier.

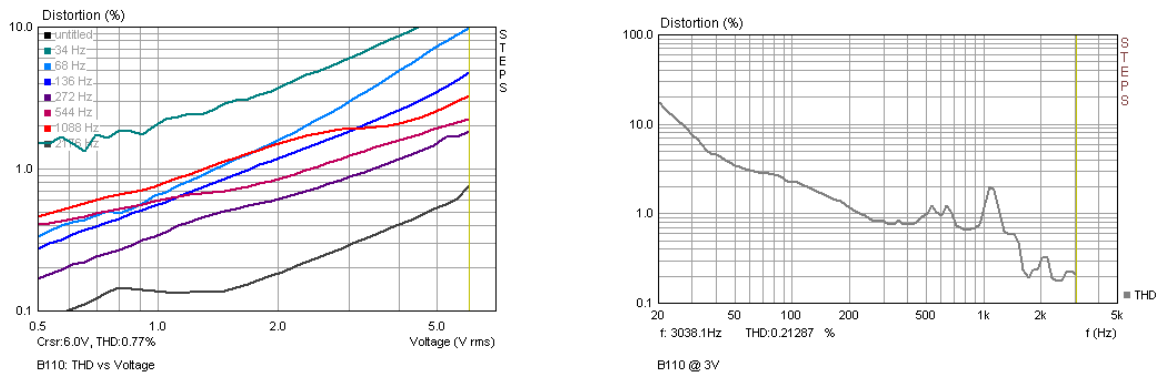

Figure 3.3.3 Left: THD vs voltage at different frequencies; right: THD at 3 volts.

Figure 3.3.3 (left) shows THD at different frequencies in relation to voltage for a 5" woofer. The right panel shows distortion as a function of frequency at about 3 volts. The distortion readings at 3 volts in the right-hand panel for all frequencies correspond to those in the left-hand panel where each individual frequency trace crosses 3 volts on the X axis.

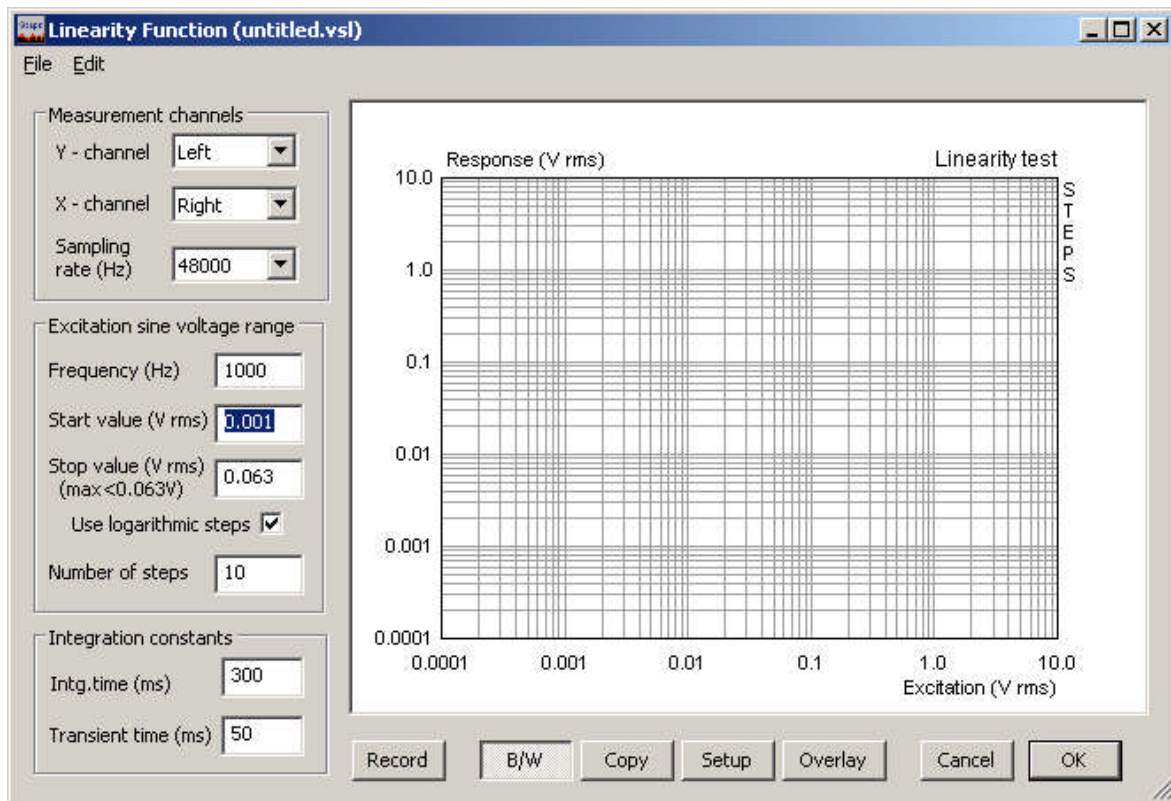

Figure 3.3.4 Linearity Function window (X vs Y).

Under '**Linearity Function**', the relationship between two quantities can be measured. Available options are shown under 'Measurement Channels' (Figure 3.3.4). Both left and right channels can be selected for either excitation or recording.

Figure 3.3.5 shows a simple linearity test for a cheap onboard soundcard.

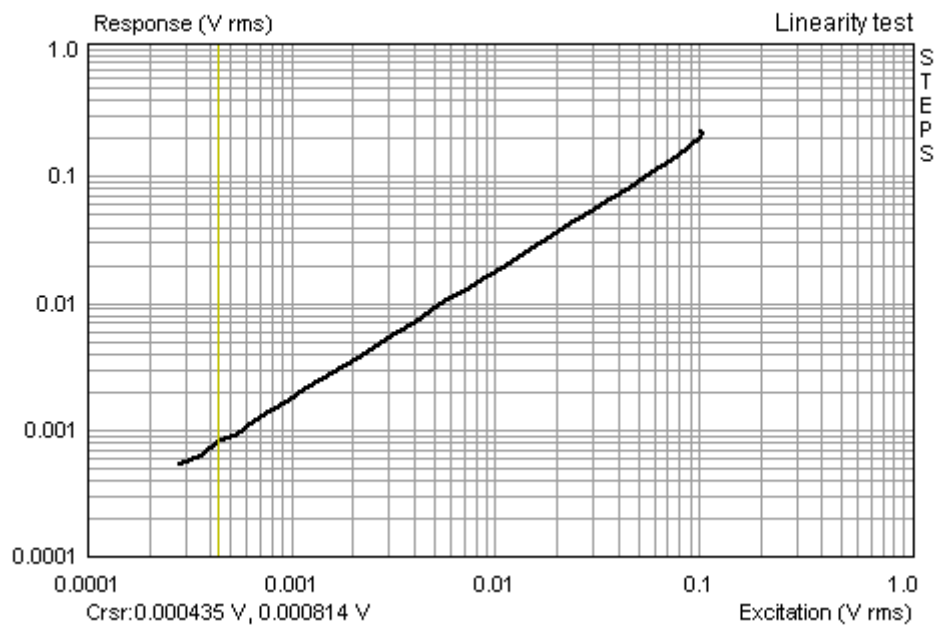

Figure 3.3.5 Onboard soundcard linearity test.

3.4. Measuring maximum linear cone displacement with STEPS

The maximum linear displacement of a driver determines its maximum undistorted SPL across a given frequency range. AES2 (2) defines this as:

The voice-coil peak displacement at which the 'linearity' of the motor deviates by 10%. Linearity may be measured by percent distortion of the input current or by percent deviation of displacement versus input current. The manufacturer shall state the method to be used.

This recommendation has been extended by Klippel (3) and is now included in the standard IEC 62458: *Sound system equipment - electroacoustical transducers - Measurement of large signal parameters*. The same standard has been implemented in STEPS since release 1.4.

The measurement setup for the determination of peak linear displacement is shown Figure 3.4.1.

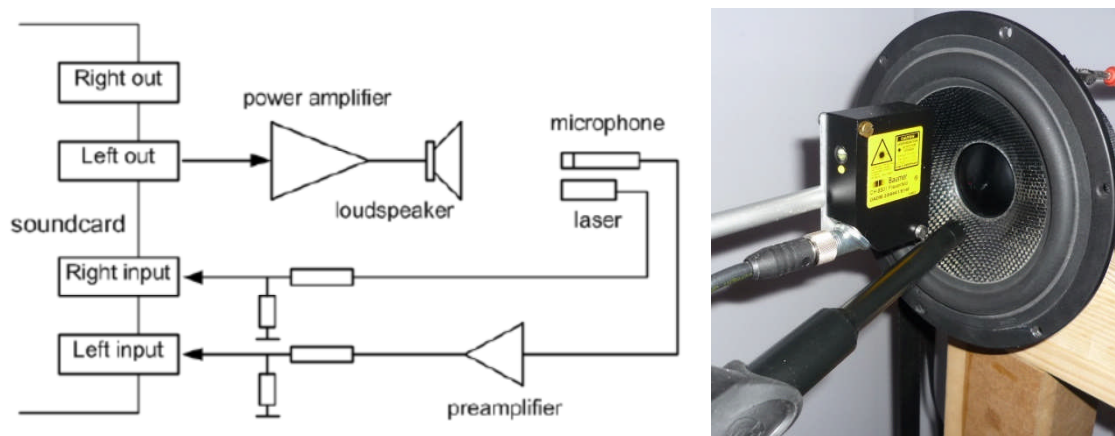

Figure 3.4.1 'Klippel Light' measurement setup.

Figure 3.4.2 shows the 'Loudspeaker Displacement/Distortion' window. Although full functionality is described in ARTA Application Note AP7 (1), a safety feature not included in 'Distortion vs Amplitude' is discussed here. This is the 'THD break value', whereby a voltage cut-off can be set to protect the system under test.

Figure 3.4.3 shows distortion vs voltage for a tweeter with two different crossovers (18dB, 6dB slope) at 2.6 kHz. Here the tweeter has handled the applied voltages better than expected, and the break value of 1% has not been reached.

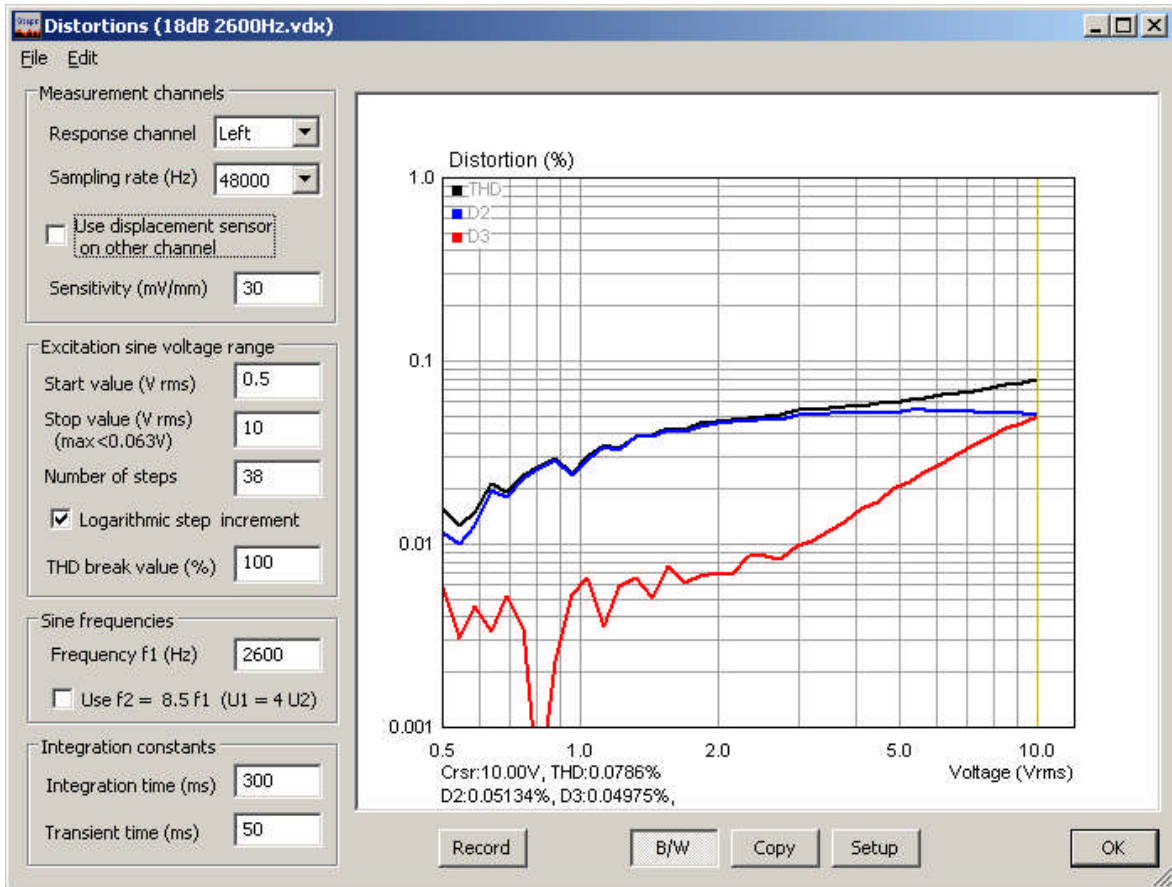

Figure 3.4.2 Loudspeaker Displacement/Distortion window.

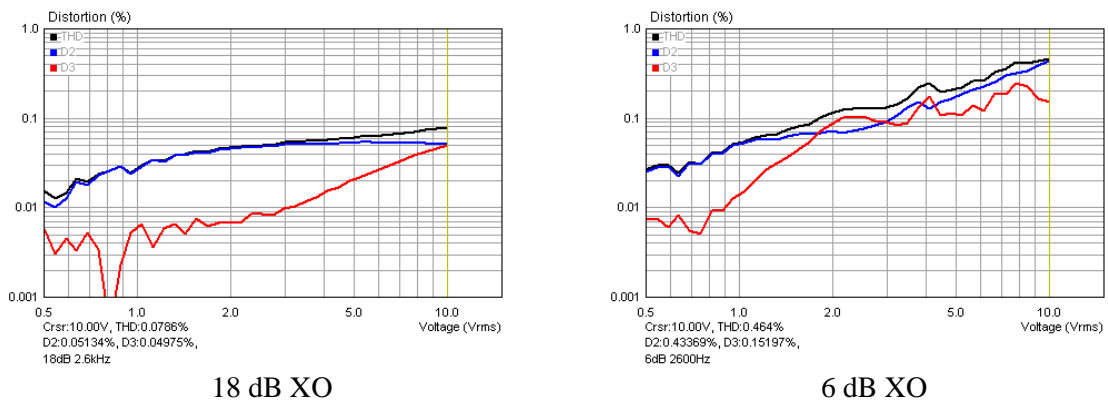

Figure 3.4.3 Distortion vs voltage for a tweeter with two different crossovers ($f = 2f_s$).

3.5. Measuring THD-limited maximum SPL with STEPS

To assess loudspeaker performance, we need in, addition to frequency-and impedance response, information on directivity and the achievable limits to which the speaker can be driven. This last factor is particularly relevant to PA loudspeakers. Manufacturers tend to quote excessively optimistic sensitivity and power characteristics for their drivers (see also Figure 3.5.4). Effects such as compression, partial vibration and the limits of displacement of the driver membrane tend to be glossed over, and the theoretical capabilities of drivers are often greatly overstated (4), especially at high and low frequencies.

The determination of THD-limited maximum SPL with STEPS solves this problem. A pure sine wave at predetermined frequency intervals is used to determine SPL at given distortion levels.

Caution: the procedure is carried out at VERY high sound levels!



Before carrying out measurements of this type, the following should be observed.

- Use ear protection. The sound levels developed are capable of causing irreparable hearing damage.
- Protect your speakers! Read this whole section completely before starting to test.
- The measurement of THD-limited maximum SPL of drivers and speaker cabinets requires suitable equipment and the right measurement environment. Ideally, these will include a professional measurement microphone with a high maximum SPL capability, an anechoic chamber (RAR) and a high-power amplifier. Problems with the measurement microphone or environment can significantly affect results (see also section 3.2.1).

Notwithstanding the above, however, comparative measurements are of course also possible with semi-professional equipment and in normal rooms.

Figure 3.5.1 shows the Distortion Limited Levels window with its functions. The main header menus are as follows:

File

- **Open** - Opens binary files with measurement data (.msp)
- **Save As** - Saves data as binary .msp file
- **Export** - Exports data in ASCII or Excel CSV format.

Edit

- **B/W** - Switches display between black and white and color
- **Copy** - Copies the current graph to the clipboard
- **Scale maximum level** - Allows you to scale the trace, e.g. to correspond to measurement at 1 meter (adds/subtracts the value entered from the trace)

The footer control buttons are as follows:

- **Record** - Start the measurement. Clicking again stops the measurement
- **Copy** - Copies the current graph to the clipboard in .bmp format
- **B/W** - Switch between black and white and color
- **Setup** - Opens the Graph setup menu
- **Overlay** - Opens the overlay menu
- **Cancel** - Closes the window without saving the setup
- **OK** - Closes the window and saves the current setup.

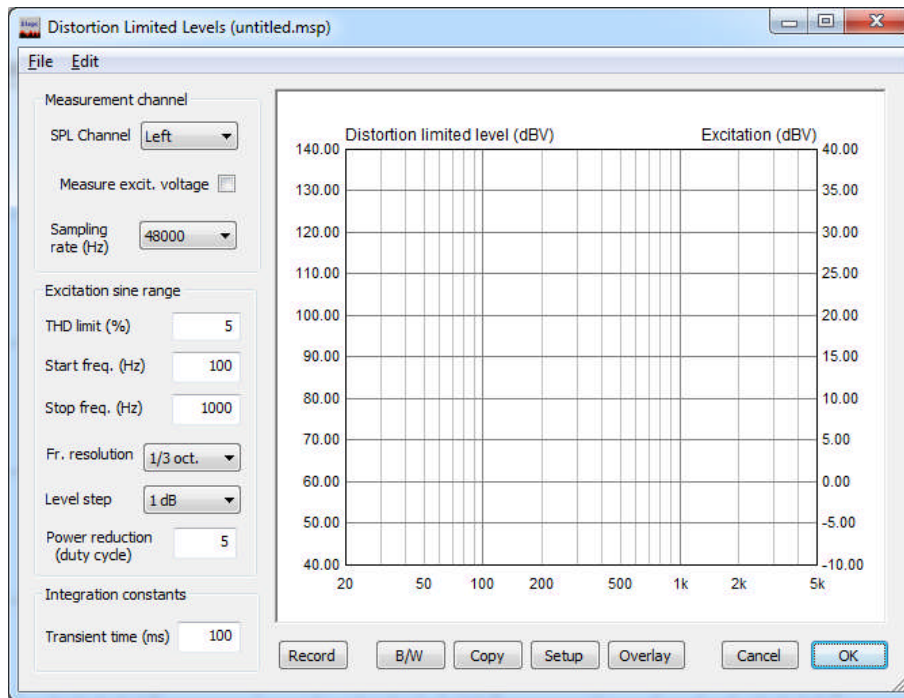

Figure 3.5.1 Distortion Limited Levels window.

The controls on the left side of the window have the following functions:

Measurement channels

- **SPL channel** - Selecting the input channel for the microphone (default = line in left)
- **Measure excit. voltage** - Measures the output voltage of the power amplifier when the box is ticked
- **Sampling rate (Hz)** - Selects sampling frequency

Excitation sine range

- **THD limit (%)** - Enter the THD limit (termination criterion)
- **Start freq. (Hz)** - Enter the start frequency
- **Stop freq. (Hz)** - Enter the stop frequency (see note)
- **Freq. resolution** - Frequency resolution (1/1, 1/6, 1/9, 1/12 octave)
- **Level step (dB)** - Choice of resolution level (0.5, 1.0, 1.5, 2.0dB)
- **Power reduction factor** - Input a value between 2 and 1000 describes the ratio of signal duration + pause duration to signal duration. This ratio is proportional to the ratio of peak power to the total power output during signal generation

Integration constants

- **Transient time (ms)** - Enter the time to steady state (see also Section 3.1).

Note: STEPS needs at minimum the second and third harmonics in order to be able to calculate THD in this part of the program. The upper frequency limit is determined accordingly by the sampling rate of the sound card (96kHz sampling rate = upper frequency limit of 12kHz).

The menu item 'Setup' at the bottom of the window opens the Graph Margins menu (Figure 3.5.2). The chart axes are defined here.

Frequency range

- **High (Hz)** - Defines the upper frequency limit
- **Low (Hz)** - Defines the lower frequency limit

SPL range (dB re 20uPa) section

- **Top (dB)** - Defines the upper level limit in dB
- **Range (dB)** - Defines the level range in dB

Excitation Voltage (dBV) section

- **Top (dBV)** - Defines the upper voltage limit in dB
- **Range (dBV)** - Defines the voltage range in dB

Show excitation voltage - The measured excitation voltage is plotted when this is activated.

Note: If the 'Microphone used on' checkbox in the Audio Devices Setup menu (Figure 3.5.6) is not activated, 'Distortion Limited Level' is shown in dBV, otherwise 'Distortion Limited SPL' is shown in dB.

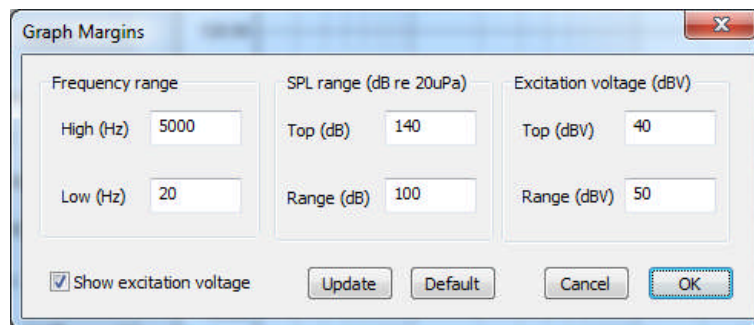

Figure 3.5.2 Graph Margins menu.

The measurement setup for THD-limited maximum SPL is shown in Figure 3.5.3. For the maximum SPL measurement, determination of the voltage being delivered by the power amplifier is not absolutely necessary (right input), but it does provide additional control over the excitation level used during measurement. For this reason, the complete measurement set-up is described here.

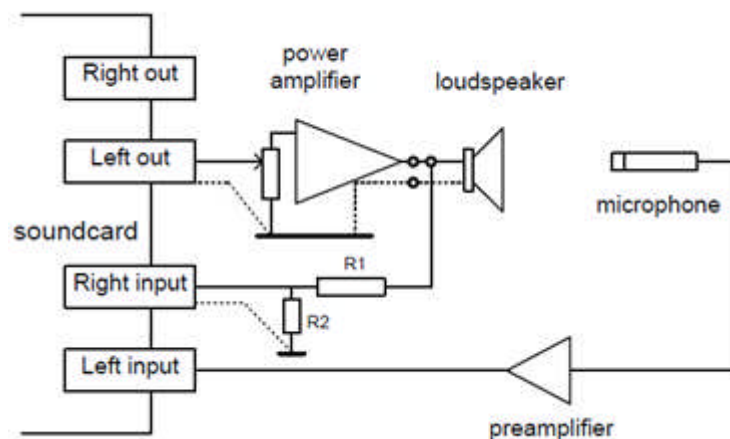

Figure 3.5.3 Setup for THD-limited maximum SPL measurement.

It takes a lot of power to get 10% THD from a speaker. As an example, Figure 3.5.4 shows a BoxSim simulation for maximum load and input voltage for a small PA monitor. The maximum load capacity is defined by either maximum displacement or electrical load.

As stated earlier, this simulation is somewhat optimistic, but it shows that in the region above 200Hz the THD-limited maximum SPL measurement of this speaker would need to be carried out at 100–200 watts – assuming that the 5% to 10% THD limit is reached before the speaker fails altogether. For testing at a low frequency, however, as little as 10–50 watts would suffice.

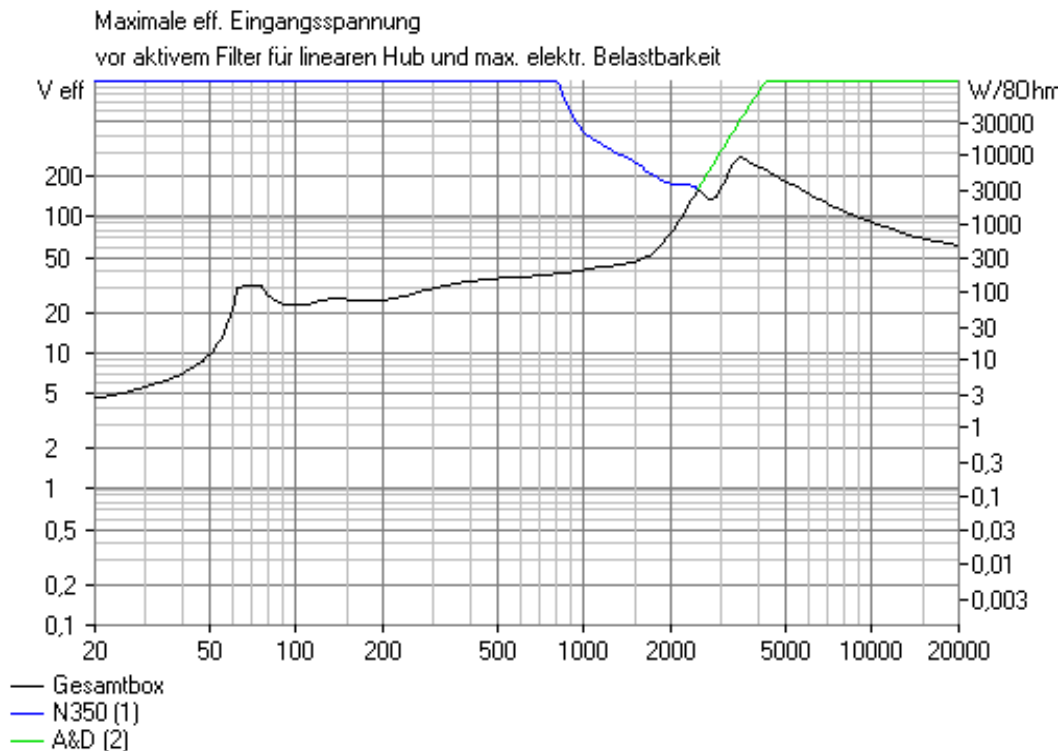

Figure 3.5.4 Theoretical maximum load of a small PA monitor (BoxSim).

The use of power amplifiers at these levels is guaranteed to overload the right input channel of the soundcard and cause irreparable damage, so a voltage divider is mandatory. The component values will depend on the amplifier's output.

Although we know that high-power amplifiers are needed to THD-limited measurements, for practical reasons the following example uses the Thomann t-amp discussed in the ARTA Handbook and the soundcard specifications shown in Figure 3.5.5.

Hi-Z Instrumenteneingang

- Type: unsymmetrisch 6.3mm Klinke
- Max. Eingangspegel: +4.5dBV max
- THD+N: 0.003% A-gewichtet
- Impedanz: 500 kOhm

Figure 3.5.5 Soundcard line in specifications, ESI UGM96 (*Instrumenteneingang = input specs; unsymmetrische 6.3mm Klinke = unbalanced 6.3mm jack; Max. Eingangspegel = max. input level; A-gewichtet = A-weighted; Impedanz = impedance*).

- Maximum soundcard input voltage $U_{IN\ MAX} = +4.5\text{dBV} = 1.0 * 10^{(4.5/20)} = 1.679\text{V RMS}$
- Soundcard input impedance $Z_{IN} = 500\text{kOhm}$
- Amplifier power $P = 25\ \text{watts}$ (see note and Figure 3.3.2).

Note: It is not always a good idea to rely on manufacturer's specifications. The t-amp is rated at 36 watts into 8 ohms, but Figure 3.3.2 suggests that in reality this should be 24 watts. Thus, rather than turning the volume control to its maximum, the input sensitivity of the power amplifier and the maximum output voltage of the sound card should be adjusted. Back off the volume until, with 0 dBFS feeding in from the sound card, the amplifier output just stops clipping. This should be the maximum excitation voltage for measurement, and should form the basis for calculation of the voltage divider components.

Using Ohm's law, the maximum output voltage is calculated for a load impedance $Z = 8$ ohms as follows:

$$U = \text{SQRT}(P * Z)$$

$$U = \text{SQRT}(25 * 8) = 14.14\text{V}$$

$$G_{\text{IN}} = U_{\text{IN MAX}}/U_{\text{OUT AMP MAX}} = 1.679/14.14 = 0.1187 = -18.51\text{dB}$$

Thus, a voltage divider giving about 19dB of attenuation is required.

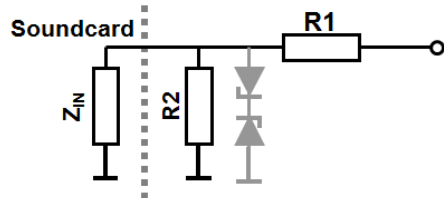

$$G = R2 / (R1 + R2) \quad [1]$$

$$R1 = (R2 / G) - R2 \quad [2]$$

For a value of $R2 = 100$ ohms, $R1$ is calculated as follows [2]:

$$R1 = (R2/G) - R2 = (100/0.1187) - 100 = 742.45 \text{ ohms } (\rightarrow 820 \text{ ohms})$$

$$G_{\text{IN}} = 100/(820+100) = 0.1087 = -19.28\text{dB}$$

Note: The Zener diodes shown in grey are not strictly necessary, but offer additional protection for your sound card input. If you do not like using Zener diodes they can be omitted (see also ARTA Application Note 1 – The ARTA Measuring Box (1)).

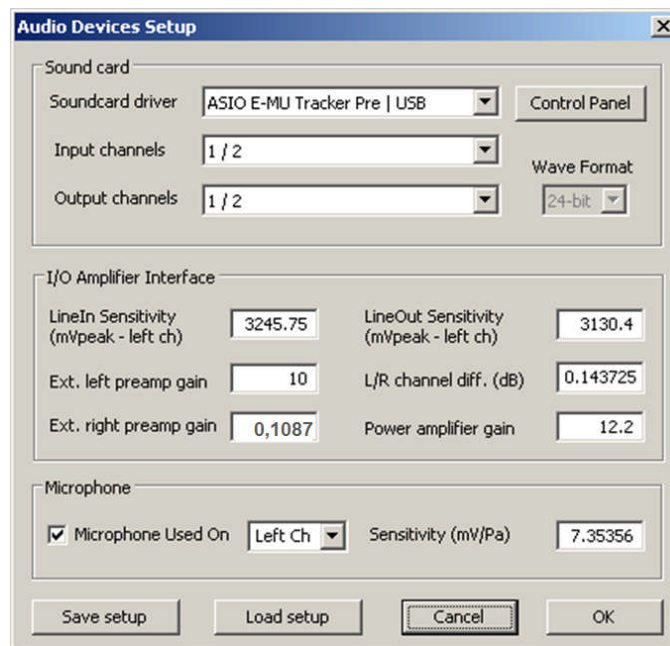

Figure 3.5.6 Audio Devices Setup.

The value calculated for the attenuating effect of the voltage divider is entered in the 'Ext. right preamp gain' field in Audio Devices Setup.

After this is done, calibration can begin using the setup shown in Figure 3.5.3. To do this, use the sine wave generator in Measurement Setup (Figure 3.5.7) with the generator set to e.g. -30dB re FS and a test frequency that can be measured reasonably accurately with your multimeter.

This will be the signal that is sent to the power amplifier and used to adjust the output voltage.

$$U_{\text{Calib}} = U_{\text{AMP}}/G, \text{ where } G = 10^{(\text{Generator Level}/20)} = 10^{(3/20)} = 1.413$$

and, for our example, $U_{\text{Calib}} = 14.14/1.413 = 10.00\text{V}$

This completes the calibration.

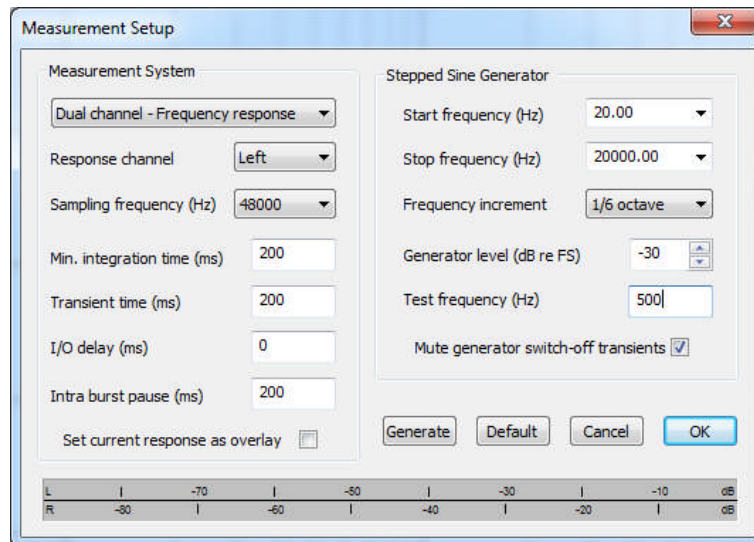

Figure 3.5.7 Measurement Setup.

Before beginning the first measurement, please bear in mind the following (4):

- For robust results, distances between the measurement setup and reflecting surfaces should be much greater than the distance between the speaker and microphone (see also ARTA Handbook Section 6.3).
- Familiarize yourself with the likely limits of the speaker before carrying out maximum level measurements. Is mechanical or thermal overload likely to cause failure? A preliminary simulation in e.g. AJ-Horn or BoxSim could help here. In principle, woofers are more mechanically vulnerable, while crossover-protected midranges and tweeters tend to experience thermal failure (see Figure 3.5.11).
- In speakers without protection circuitry, crossover components may also be at risk of thermal overload.
- Carry out a preliminary test at 'normal' levels in STEPS or in ARTA with the Farina method: use approximately 10% of the rated power of the speaker. This is likely to indicate any potential weak points in the speaker under test.
- Adjust the lower frequency limit carefully. Do NOT start the maximum level measurement at a frequency significantly below the resonant frequency of the speaker. This is especially true for midranges and tweeters. Bass reflex speakers should not be tested any more than half an octave below the tuning frequency.
- THD limits have been shown to be between 1% and 3% for hi-fi speakers, and 5% to 10% for PA systems (4).
- Start your measurements as a precaution with a high Power Reduction Factor (e.g. 50-100). This gives the voice coil time to cool down.
- Take care not to choose full frequency resolution, the smallest step and high THD limit for the first measurement, as such a measurement will take a long time and will place a heavy load on the speaker.
- If the peak power handling of the speaker is known, and the power amplifier can deliver a peak power P_{MAX} , Power Reduction Factor should = P_{max}/P .
- Assume as a precaution that tweeters will only tolerate 1–2 watts of continuously supplied sine wave power. For our above-mentioned 25 watt t-amp power amplifier, the Power Reduction Factor would be $25/2 = 13$.

Figure 3.5.8 shows a 3% THD-limited maximum level measurement for a 3.5-inch full-range driver in a bass reflex enclosure. The measurement was performed at 20cm, and is level-corrected ('Edit' → 'Scale'). The red curve shows the measured maximum level in dB and the grey curve the excitation voltage in dBV.

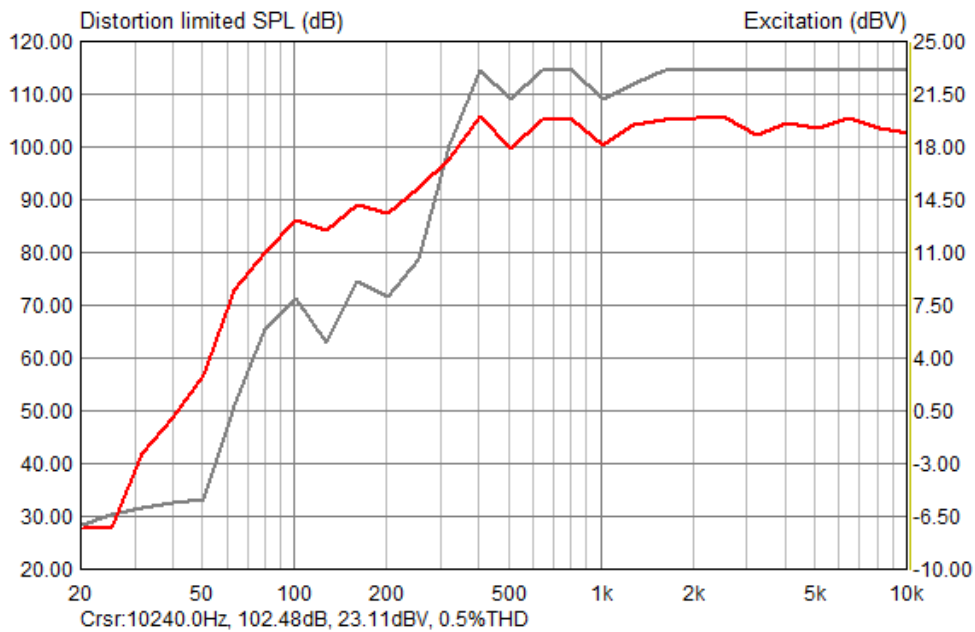

Figure 3.5.8 Measurement of a 3.5" full-range driver up to THD = 3%.

We know that the amplifier can only provide power up to about 23 dBV or 14.10 volts. For this speaker, this is obviously insufficient to achieve the chosen THD limit of 3% from about 1.5kHz.

Figure 3.5.9 shows the same speaker measured at 0.5%, 1.0% and 3.0% THD. The individual curves were generated using the overlay function. Here, even without the addition of the Excitation (dBV) axis, we can see that around 2kHz the amplifier is unable to supply enough power because the red and blue traces are superimposed.

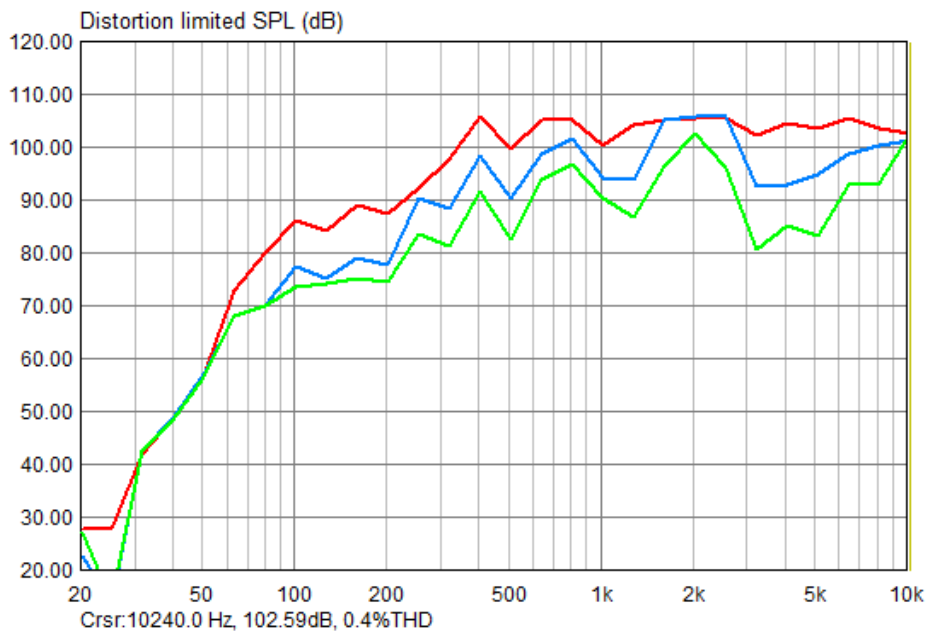

Figure 3.5.9 Measurement of a 3.5" full-range driver (THD = 0.5%, 1.0% and 3.0%).

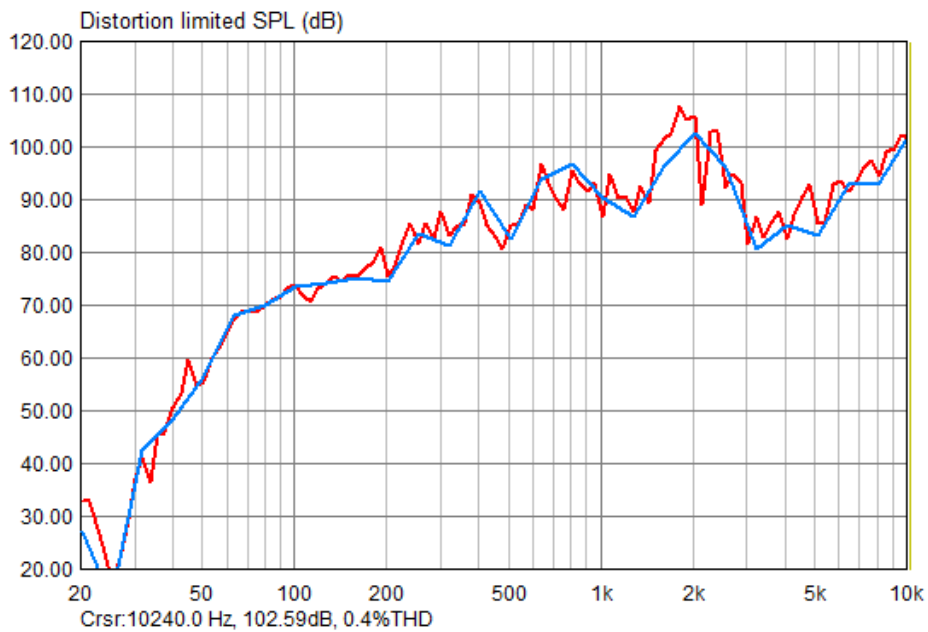

Figure 3.5.10 Varying frequency resolution and step increments.

Figure 3.5.10 shows a measurement taken with a 0.5% THD limit at differing frequency resolution and step increments. The blue trace was generated with 1/3 octave resolution and 1dB step levels, while the red trace shows 1/12 octave resolution and a 0.5dB step level. The improved resolution and closer approximation to the defined THD limit is obtained at the price of a much longer measurement time and a greater load on the device under test.

Have fun taking THD-limited maximum SPL measurements, but do make sure that your tests do not end up causing the kind of damage shown in Figure 3.5.11!



Figure 3.5.11 Test victims.

4. References

1. ARTA Support [Internet]. [cited 2014 Sep 21]. Available from: <http://www.artalabs.hr/support.htm>
2. AES. AES2-2012: AES standard for acoustics - Methods of measuring and specifying the performance of loudspeakers for professional applications – Drive units. 2012.
3. Klippel GmbH. Measurement of Peak Displacement Xmax (performance-based method) [Internet]. 2012 [cited 2014 Jul 26]. Available from: http://www.klippel.de/nc/know-how/application-notes.html?sword_list%5B0%5D=an4
4. Four Audio | Monkey Forest. MF Audio Measuring System [Internet]. 1999 Dec [cited 2014 Jul 27]. Available from: <http://www.four-audio.com/en/products/monkey-forest.html>