

**MSO/DPO2000, MSO/DPO3000, and MSO/DPO4000 Series Oscilloscope  
Demo 2 Board  
Instruction Manual**



  
071-2347-01

**Tektronix**



**MSO/DPO2000, MSO/DPO3000, and MSO/DPO4000 Series Oscilloscope  
Demo 2 Board  
Instruction Manual**

[www.tektronix.com](http://www.tektronix.com)  
071-2347-01

**Tektronix**

Copyright © Tektronix. All rights reserved. Licensed software products are owned by Tektronix or its subsidiaries or suppliers, and are protected by national copyright laws and international treaty provisions.

Tektronix products are covered by U.S. and foreign patents, issued and pending. Information in this publication supersedes that in all previously published material. Specifications and price change privileges reserved.

TEKTRONIX and TEK are registered trademarks of Tektronix, Inc.

FilterVu and Wave Inspector are trademarks of Tektronix, Inc.

For safety information on your oscilloscope, refer to its user manual.

## Contacting Tektronix

Tektronix, Inc.  
14200 SW Karl Braun Drive  
P.O. Box 500  
Beaverton, OR 97077  
USA

For product information, sales, service, and technical support:

- In North America, call 1-800-833-9200.
- Worldwide, visit [www.tektronix.com](http://www.tektronix.com) to find contacts in your area.

# Table of Contents

Getting Started with the MSO/DPO2000, MSO/DPO3000, and MSO/DPO4000 Series Oscilloscopes .....	1
Demo I: Acquiring a Signal.....	2
Demo II: Using Vertical Controls.....	6
Demo III: Using Horizontal Controls .....	8
Demo IV: Using Run/Stop Controls.....	9
Demo V: Using Trigger Controls .....	9
Demo VI: Using Cursors .....	12
Demo VII: Taking Measurements .....	14
Demo VIII: Saving a Screen Image.....	17
Giving Demos of Advanced Oscilloscope Features .....	21
Overall Package.....	21
MSO/DPO4000 Series Performance .....	22
MSO/DPO3000 Series Performance .....	23
MSO/DPO2000 Series Performance .....	24
Wave Inspector Demos .....	25
Demo IX: Setting Up I <sup>2</sup> C Signals .....	26
Demo X: Using the Wave Inspector's Zoom and Pan Functionality .....	31
Demo XI: Using the Wave Inspector's Search Functionality.....	37
Demo XII: Using Serial Triggering and Analysis .....	42
Demo XIII: Searching Serial Signals.....	55
Demo XIV: Monitoring and Decoding RS-232 Signals .....	59

Demo XV: Triggering on a Serial Data Pattern (e.g. RS-232) .....	67
Demo XVI: FilterVu (MSO/DPO2000) .....	70
Giving Demos of MSO Features .....	79
Ease of Use .....	79
Performance .....	79
Tour the MSO Front Panel .....	81
Demo XVII: Setting up Digital Channels (MSO2000, MSO3000, and MSO4000 Models) .....	82
Demo XVIII: Discovering Per-Channel Thresholds (MSO4000 Only) .....	89
Demo XIX: Labeling Channels (MSO2000, MSO3000, and MSO4000 Models) .....	91
Demo XX: Exploring Parallel Buses (MSO2000, MSO3000, and MSO4000 Models) .....	93
Demo XXI: Triggering on Parallel Bus Data Values (MSO2000, MSO3000, and MSO4000 Models) .....	99
Demo XXII: Searching for Parallel Bus Data Values (MSO2000, MSO3000, and MSO4000 Models) .....	102
Demo XXIII: Zooming in on White Edges (MSO4000 Only) .....	104
Troubleshooting .....	111
Locating Signals .....	112

# Getting Started with the MSO/DPO2000, MSO/DPO3000, and MSO/DPO4000 Series Oscilloscopes

These instructions quickly guide you through basic controls and capabilities of the MSO/DPO2000, MSO/DPO3000, and MSO/DPO4000 series oscilloscopes. To learn about more advanced capabilities, read the corresponding oscilloscope user manual.

---

**NOTE.** *The MSO4000 and DPO4000 series oscilloscopes described in this manual require firmware version 2.XX or higher. To check the firmware version number, push the Utility front panel button and view the Version. If your oscilloscope uses firmware version 1.XX, download new firmware and update your oscilloscope using procedures described in your oscilloscope user manual.*

---

---

**NOTE.** *This manual is part of the Tektronix 020-2924-XX Demo 2 board kit. The kit includes a Demo 2 board, this manual, and a USB cable.*

---

## Demo I: Acquiring a Signal

1. Connect the host side of the USB cable to the USB port on the lower-left corner of the oscilloscope front panel — or to either of the two USB host ports on the rear panel of some models.
2. Connect the other end of the cable to the device port on the Demo 2 board.
3. The **POWER** LED will light on the Demo 2 board.

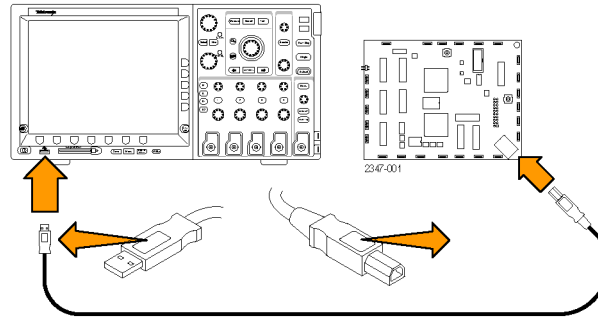



4. Connect a probe to channel 1, such as the P2221 with the MSO/DPO2000 or the P6139A with the MSO/DPO3000 or MSO/DPO4000. Then connect the ground lead of the probe to a point labeled **GND** on the Demo 2 board. Attach the probe tip to the square pin on the Demo 2 board labeled **CNT CLK**.

---

**NOTE.** *CNT CLK* is a clock used for a synchronous counter.

---

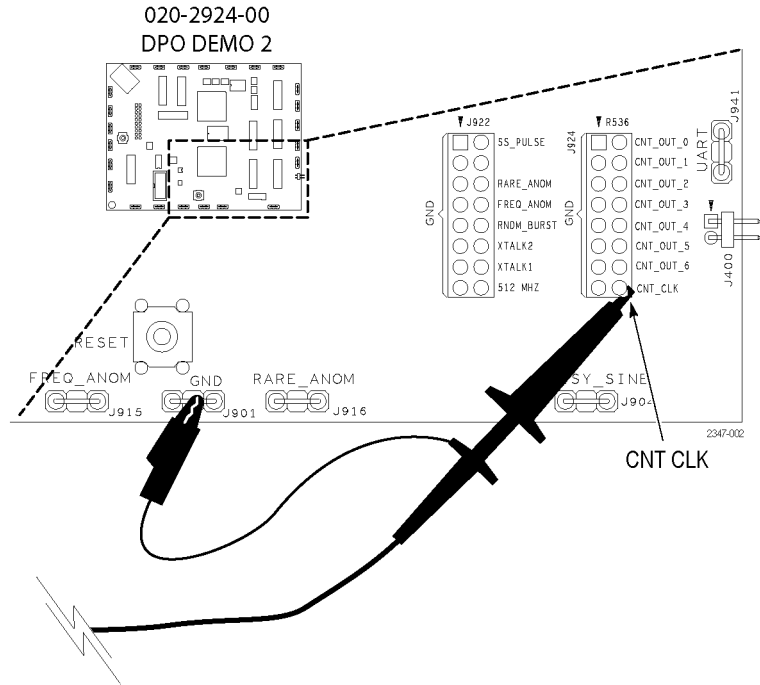

5. Push **Default Setup** to put the oscilloscope back to a known starting point. In general, this is a good thing to do any time you are starting a new task.

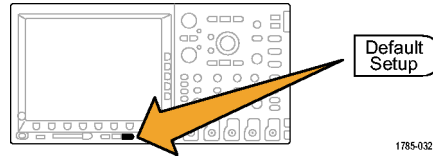

6. Push **Autoset**.  
Autoset automatically adjusts the horizontal, vertical, and trigger parameters to give a usable display of the signal of interest. You should now see several cycles of the clock signal.

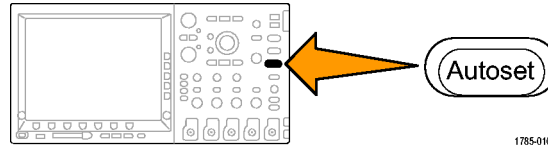

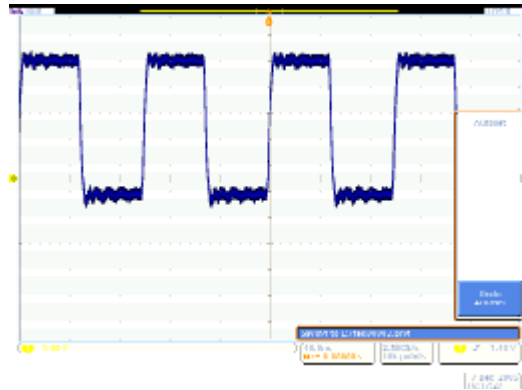

## Demo II: Using Vertical Controls

1. Turn the front-panel channel 1 Vertical **Scale** knob in both directions and observe how the display changes. Also, notice the channel 1 readout on the lower left of the display shows the current volts/div setting. Set the Vertical Scale to 1 V/div.
2. Turn the front-panel channel 1 Vertical **Position** knob in both directions and observe how the display changes. Position the waveform in the center of the display.

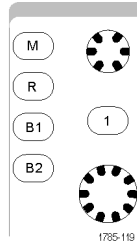

3. Push the front-panel channel 2 button to turn on channel 2. Push it again to turn off channel 2.

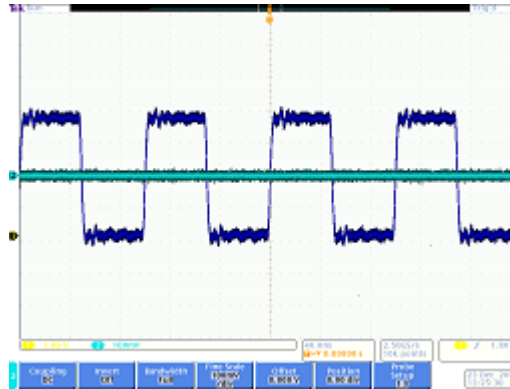

## Demo III: Using Horizontal Controls

1. Turn the front-panel Horizontal **Scale** knob in both directions and observe the display. Also, notice the horizontal readout indicating the current time/div setting. Set the Horizontal Scale to 200 ns/div.
2. Turn the front-panel Horizontal **Position** knob both directions and observe the display. Notice that this affects the trigger position icon (the big T on an orange background). Return the trigger position icon to center screen.
3. Take a look at the graphic shown above the graticule. The long yellow bar represents the overall acquisition while the gray brackets indicate the portion of the acquisition you are looking at on the screen.

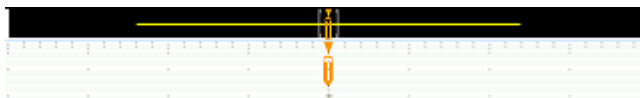
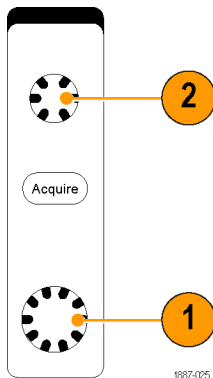

## Demo IV: Using Run/Stop Controls

1. Push the **Run/Stop** button. This stops acquisitions with the last acquired waveform on the display.
2. Push **Single** to have the oscilloscope acquire a single waveform and then stop.
3. Push the **Run/Stop** button again to restart acquisitions.

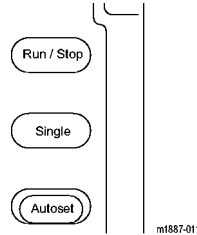

## Demo V: Using Trigger Controls

1. Turn the Trigger **Level** knob in both directions and observe the display. Turn it far enough to move the trigger level off the waveform.

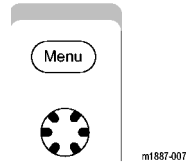

Notice that the oscilloscope loses its stable trigger and the waveform now appears to randomly scroll by.

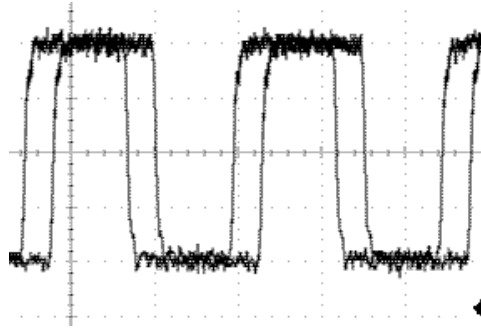

2. Push the **Force Trig** button once and notice that the oscilloscope shows a single acquisition for a moment. This gives you an idea of what the waveform looks like so you can set an appropriate and stable trigger.





3. On the MSO/DPO4000, push the **Set to 50%** button. This automatically sets the trigger level to the midpoint of the signal for a stable trigger.  
On the MSO/DPO2000 and MSO/DPO3000, push the **Level** knob. This will set the trigger level to the midpoint.

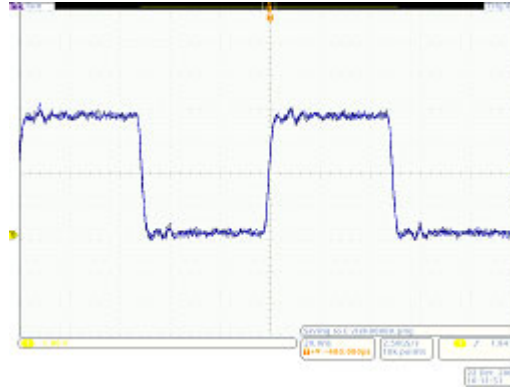

## Demo VI: Using Cursors

1. Push the front-panel **Cursors** button.

Two vertical bar cursors now appear in the graphic above the graticule. The corresponding cursor readout displays the time of each cursor relative to the trigger and amplitude along with the deltas between the cursors.

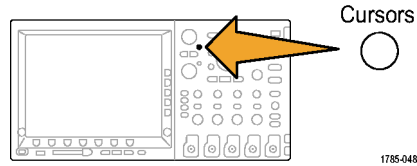

2. Using the multipurpose **a** and **b** knobs, bring the cursors on screen.

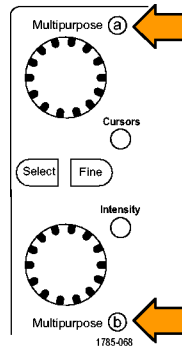

Hint: To move the cursors faster, turn off fine mode by pushing the **Fine** button, if lit, on the front panel between the two multipurpose knobs.

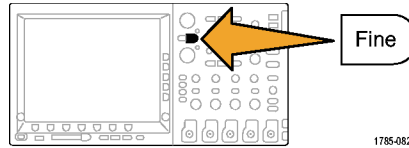

1785-082

- Place one cursor at the midpoint of the first falling edge. Place the other cursor at the midpoint of the second falling edge to measure the signal's period. The cursor readout should show a difference between the cursors of approximately 800 ns.

Hint: To move the cursors more slowly, turn the fine mode back on by pushing the **Fine** button, if unlit, on the front panel between the two multipurpose knobs.

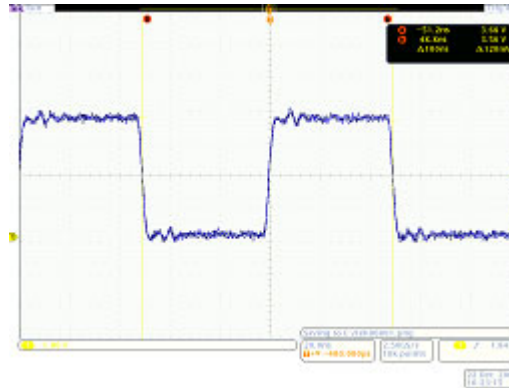

4. Push **Cursors** two more times to turn them off.

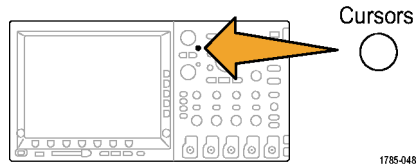

## Demo VII: Taking Measurements

1. Push the front-panel **Measure** button.

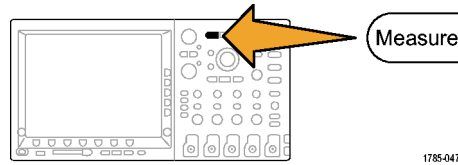

2. Push the lower-bezel **Add Measurement** button.

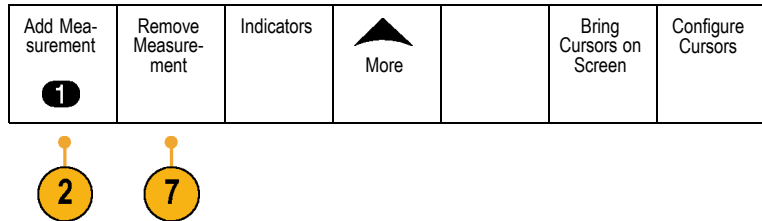

- Turn multipurpose knob a to select **Frequency**. Push the side-bezel **OK Add Measurement** button.

Frequency
Period

- Turn multipurpose knob a to select **Period**. Push the side-bezel **OK Add Measurement** button.

- Push **Menu Off** to the lower-right of the display to remove the side menu.

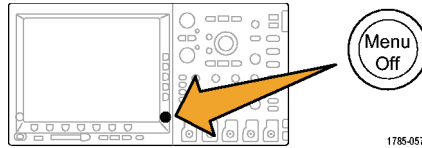

- Observe the measurement readout.

1 1	Frequency	<b>Value</b> 1.250MHz	<b>Mean</b> 1.250M	<b>Min</b> 1.250M	<b>Max</b> 1.250M	<b>Std Dev</b> 45.44
	Period	800.0ns	800.0n	799.9n	800.1n	31.98

The readout indicates the frequency and period. On the MSO/DPO3000 and MSO/DPO4000, it also shows the mean, minimum, maximum, and standard deviation of the measurements.

7. Push the lower-bezel **Remove Measurement** button.

8. Push the side-bezel **Remove All Measurements** or **Remove All** button.

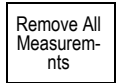

9. Push **Menu Off** to the lower-right of the display to remove the side menu. Push it again to remove the lower-bezel menu.

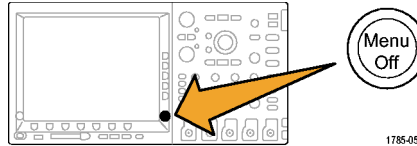

## Demo VIII: Saving a Screen Image

1. Insert a USB flash drive.

There is one USB 2.0 Host port on the front. Some oscilloscopes also have one or more ports on the rear of the oscilloscope.

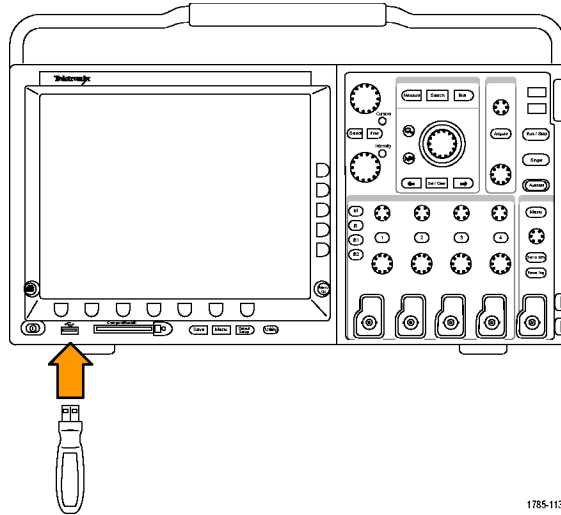

2. Push the front-panel Save/Recall **Menu** button.

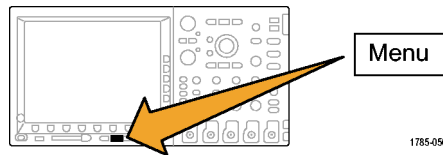

3. Push the lower-bezel **Save Screen Image** button.

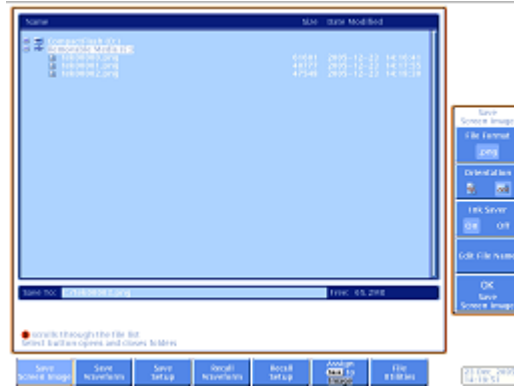

4. If needed, use multipurpose knob **a** to select the drive that you are using.

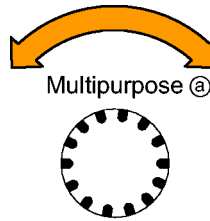

1785-039



5. Push the front-panel **Select** button.

This lets you expand or contract your view into the contents of the drive that you are using.

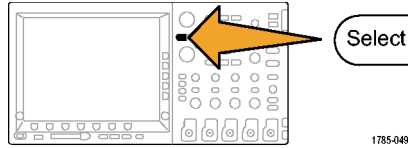

1785-048

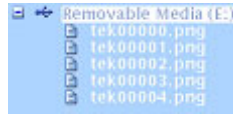

Expanded list



Contracted list

6. Select the desired file format with the side-bezel button.



7. Push **OK Save Screen Image**.

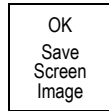

8. To easily save multiple images, push the front-panel **Save** button.

By default, the lower-bezel **Assign Save to** button is set to **Image**.

Now, whenever you push the front-panel **Save** button, a screen image with an automatically incremented filename is saved to the storage location you specified.

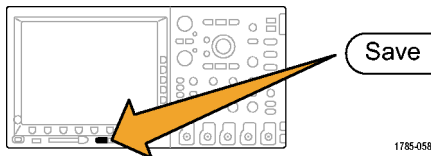

To change what is saved each time you push the front-panel **Save** button, push the lower-bezel **Assign Save to** button and then push one of the side-bezel buttons: **Screen Image**, **Waveform**, **Setup** or **Image**, **Waveform**, and **Setup**.

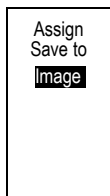

## Giving Demos of Advanced Oscilloscope Features

This section demonstrates a few features that set the Tektronix MSO/DPO2000, MSO/DPO3000, and MSO/DPO4000 series oscilloscopes apart from other oscilloscopes on the market.

### Overall Package

- **Large Display:** Oscilloscopes are visual tools and, as such, work well with large, bright displays. The MSO/DPO4000 has a 10.4-inch XGA display, the MSO/DPO3000 has a 9-inch XGA, and the MSO/DPO2000 has a 7-inch WQVGA.
- **Knob-per-Channel Vertical Controls:** Many oscilloscopes multiplex the vertical controls so you have to select a channel before changing its vertical scale or position. A separate adjustment knob for each channel makes the oscilloscope more efficient and intuitive.
- **USB Host Ports:** The front-panel USB ports make it easy to transfer screen images, oscilloscope setups, and waveform data from the oscilloscope to your workstation. MSO/DPO4000 models also have CompactFlash ports. Some oscilloscopes also have one or more USB ports on the rear of the oscilloscope.
- **Short Depth:** MSO/DPO2000, MSO/DPO3000, and MSO/DPO4000 series use a small amount of bench space, especially given its performance level, allowing customers to set their device under test in front of the oscilloscope, which is only 140 mm (5.4 inches) deep.
- **Portable:** Light weight and a sturdy handle make these oscilloscopes easily portable. The MSO/DPO4000 weighs only 5 kg (11 pounds). The MSO/DPO3000 weighs 4.17 kg (9.2 pounds). The MSO/DPO2000 weighs 4.08 kg (9 pounds).
- **Localization:** The user interface of all of these oscilloscopes is available in these 11 languages: English, French, German, Italian, Spanish, Portuguese (Brazilian), Russian, Japanese, Korean, Simplified Chinese, and Traditional Chinese.

- **5X Oversampling on All Channels:** All MSO/DPO2000, MSO/DPO3000, and MSO/DPO4000 series oscilloscopes offer  $\geq 5x$  over-sampling on all channels with  $\sin(x)/x$  interpolation standard. This ensures full-single shot bandwidth on all channels. Oscilloscopes with lower sample rates and/or linear interpolation often only offer full single-shot bandwidth on fewer channels.
- **Waveform Labels:** These oscilloscopes support adding labels to signals on the display. This is increasingly useful as the number of signals on the display increases.

## MSO/DPO4000 Series Performance

Characteristic	DPO4104 & MSO4104	DPO4054 & MSO4054	DPO4034 & MSO4034	DPO4032 & MSO4032
Bandwidth	1 GHz	500 MHz	350 MHz	350 MHz
DPO4000 Channels	4	4	4	2
MSO4000 Channels	4 + 16	4 + 16	4 + 16	2 + 16
Max Analog Sample Rate (all channels)	5 GS/s	2.5 GS/s	2.5 GS/s	2.5 GS/s
Main Record Length (all channels)	10 M	10 M	10 M	10 M
MSO4000 MagniVu Record Length (all digital channels)	10 K	10 K	10 K	10 K

**10 M Record Lengths on All Channels.** All MSO/DPO4000 series oscilloscopes offer standard 10 M record lengths on all channels. Not only is this more than any other midrange oscilloscope's standard offerings, it is also more than many offer even with very expensive options.

## MSO/DPO3000 Series Performance

Characteristic	DPO3054, DPO3052, & MSO3054	DPO3034, DPO3032, MSO3034, & MSO3032	DPO3014, DPO3012, MSO3014, & MSO3012
Bandwidth	500 MHz	300 MHz	100 MHz
DPO3000 Channels	4 or 2	4 or 2	4 or 2
MSO3000 Channels	4 or 2 + 16	4 or 2 + 16	4 or 2 + 16
Max Analog Sample Rate (all channels)	2.5 GS/s	2.5 GS/s	2.5 GS/s
Main Record Length (all channels)	5 M	5 M	5 M
MSO3000 MagniVu Record Length (all digital channels)	10 k	10 k	10 k

**5 M Record Lengths on All Channels.** All MSO/DPO3000 series oscilloscopes offer standard 5 M record lengths on all channels.

## MSO/DPO2000 Series Performance

Characteristic	DPO2024 & MSO2024	DPO2014 & MSO2014	DPO2012 & MSO2012
Bandwidth	200 MHz	100 MHz	100 MHz
DPO2000 Channels	4	4	2
MSO2000 Channels	4 + 16	4 + 16	2 + 16
Max Analog Sample Rate (all channels)	1 GS/s	1 GS/s	1 GS/s
Main Record Length (all channels)	1 M	1 M	1 M

**1 M Record Lengths on All Channels.** All MSO/DPO2000 series oscilloscopes offer standard 1 M record lengths on all channels.

## Wave Inspector Demos

### Background.

- Digital oscilloscope record lengths have gone from 500 points in the early 1980's to millions of points today.
- The MSO/DPO2000, MSO/DPO3000, and MSO/DPO4000 series place emphasis not only on the quantity of record length provided but also on the usability of the data. Imagine trying to find what you are looking for on the Web these days without search engines like Google.
- As record lengths have gotten longer, virtually every digital oscilloscope has implemented a zoom model. However, most zoom models are operated with controls buried in menus or front-panel controls that are multiplexed with other functions. The zoom controls are easily accessible on the front panel.

The following are general demonstration procedures that cover the key points of Wave Inspector and Serial Triggering and Analysis.

## Demo IX: Setting Up I<sup>2</sup>C Signals

1. Connect the ground lead of a probe to a point labeled **GND** on the Demo 2 board.  
Connect the probe from channel 1 on the oscilloscope to the **I2C CLK** test point on the Demo 2 board.
2. Connect the ground lead of a second probe to a point labeled **GND** on the Demo 2 board.  
Connect the second probe from channel 2 on the oscilloscope to the **I2C DATA** test point on the Demo 2 board.

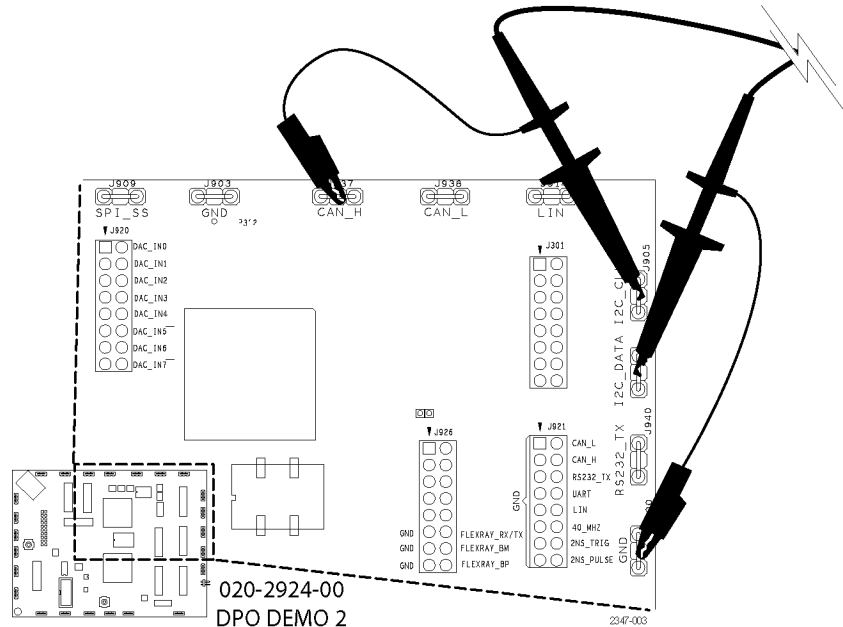



3. Push the front-panel **Default Setup** button.

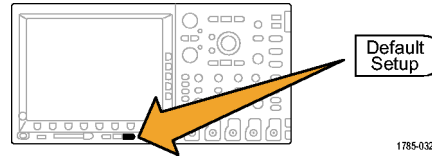

4. Turn the front-panel Trigger **Level** knob to set the trigger level to approximately 2 V.



5. Push the front-panel channel 2 button to turn on channel 2.

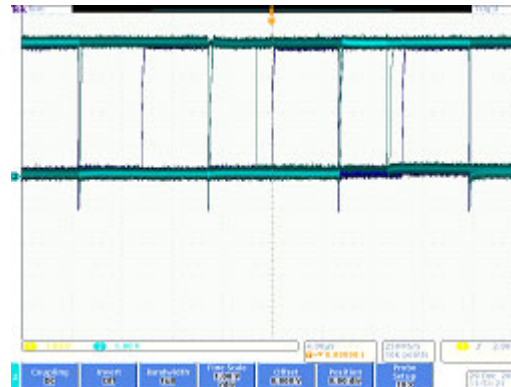

6. Turn the front-panel channel 1 and channel 2 Vertical **Scale** knobs so that both channel 1 and channel 2 are set to 2.0 V/div.



7. Turn the channel 1 and channel 2 Vertical **Position** knobs to position channel 1 near the top of the graticule and channel 2 near the middle or bottom.

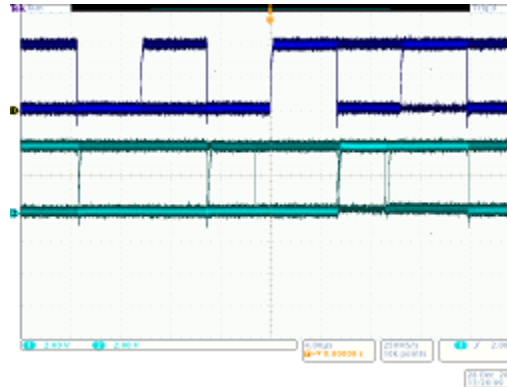

8. Push the front-panel **Acquire** button to display the acquire menu.

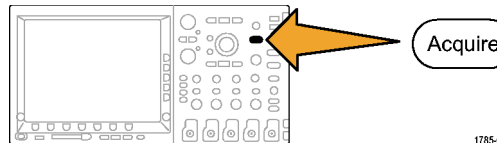

1785-046

9. Push the lower-bezel **Record Length** button (if not already active), and the side-bezel **1M points** button.
10. Turn the front-panel Horizontal **Scale** knob to set the horizontal scale to 20.0 ms/div on the MSO/DPO4000. Set it to 2.0 ms/div on the MSO/DPO2000 and MSO/DPO3000.

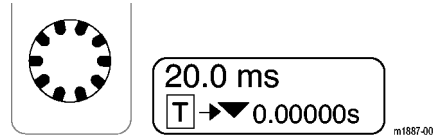

Hint: If you want to save this setup so that you can recall it at the beginning of each Demo 2, push the front-panel Save/Recall **Menu** button, the lower-bezel **Save Setup** button, and select where you want to store the setup.

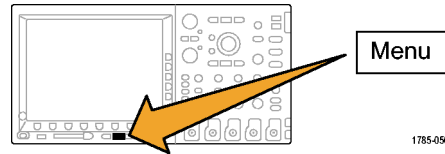

11. Push the front-panel **Single** button to acquire a single acquisition.

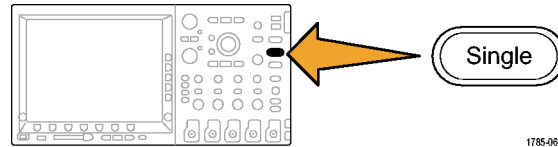

You are now looking at the clock (yellow ch1) and data (blue ch2) lines of an I<sup>2</sup>C bus.

Hint: If the waveforms do not look anything like the display to the right, go back to step 1 and confirm that you connected both probes to the correct pins on the Demo 2 board.

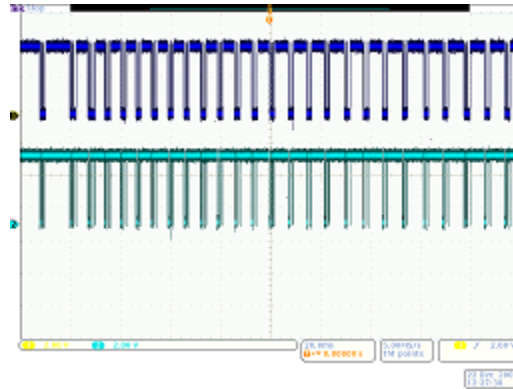

## Demo X: Using the Wave Inspector's Zoom and Pan Functionality

This section shows how to use the Wave Inspector's Zoom-Pan knob to demonstrate zoom and pan functionality.

1. Notice the Wave Inspector portion of the front panel. This set of dedicated controls makes navigating and analyzing waveforms easier.

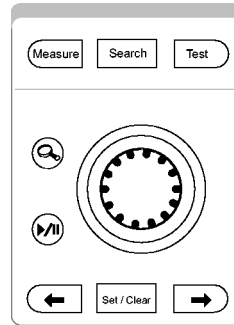

m1887-010

The pan-zoom control consists of the following:

2. An outer pan knob.
3. An inner zoom knob.

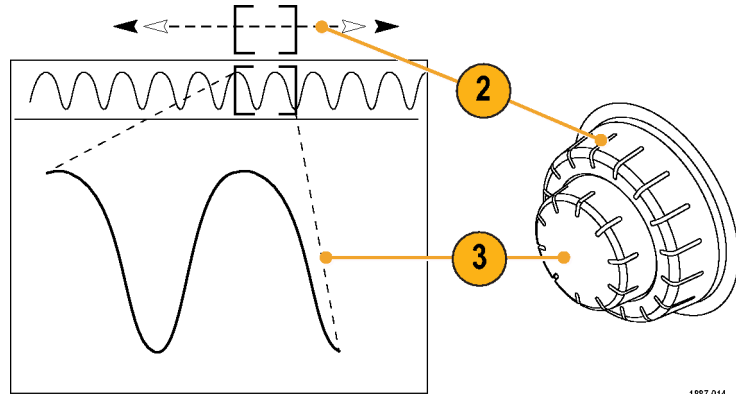

1887-014

4. Turn the zoom (inner) knob a few clicks clockwise. The zoom feature should turn on. You are seeing:

- The entire acquisition in the top window.
- What you are zooming in on within the gray top window brackets.
- The zoomed view in the bottom window.

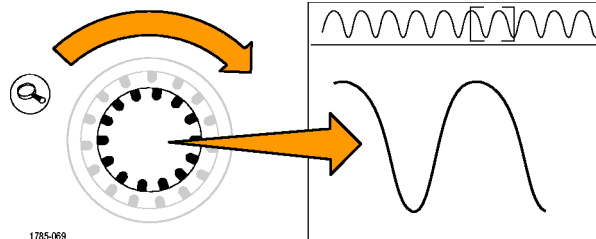

1785-069

5. Zoom in and out to illustrate how the center knob works. End in a spot where you are zoomed in on a single burst of clocks. Notice that you do not have to turn a horizontal position control many times to move the zoom window to the beginning of the acquisition, nor do you have to zoom way back out so you could move the window quickly, and then zoom back in when you arrived at the new location. This is where the pan function helps.
  
6. Turn the pan (outer) knob counterclockwise a bit. Notice the extremely intuitive nature of the zoom/pan controls.
  - Counterclockwise turning moves the zoom box left.
  - Clockwise turning moves the zoom box right.
  - The further you turn the pan knob, the faster the zoom box moves.
  - You can move from one end of the acquisition to the other end in a couple of seconds even with the MSO/DPO4000's 10 M record length!

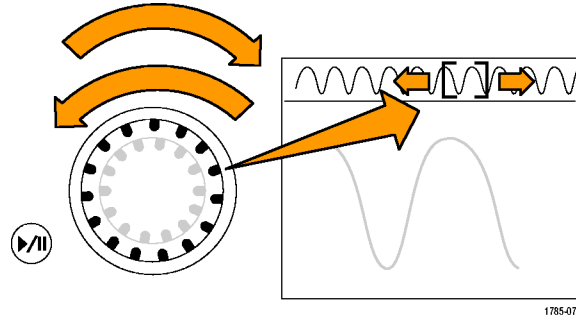

7. If you do not want to hold the pan knob while looking through the waveform, use the play/pause feature. Pressing the play/pause button will cause the oscilloscope to scroll the waveform automatically for you.

To show this, push the play/pause button. The waveform should start scrolling.

- Play speed is adjusted by turning the pan knob.
- To pan in the other direction, just turn the pan knob the other way to slow the zoom box down and have it change direction.
- To quickly jump to another portion of the record and resume playing when done, turn the pan knob all the way in that direction. This is pan on top of play/pause.
- Push the play/pause button again to stop when there is something (anything) of interest on the screen.

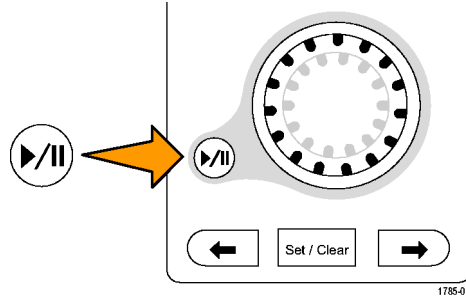



8. When you have found something in the waveform that you are interested in, mark it for further reference.
- To do this, push the **Set/Clear** button on the front panel to place a mark.

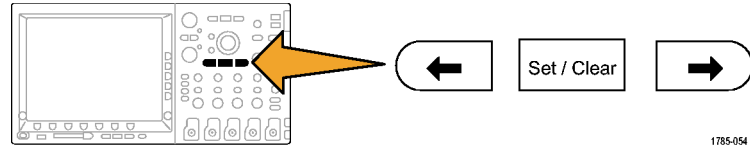

1785-054

- Notice the solid white triangle that appears on the display. Later, you will see why the triangles are solid.
- This triangle is like a bookmark on the waveform.

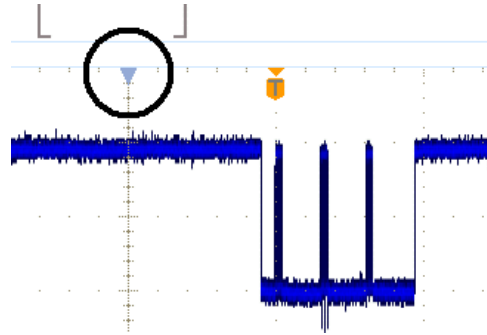

- Use the pan (outer) knob to quickly move to a few other interesting points in the waveform and place marks on them.

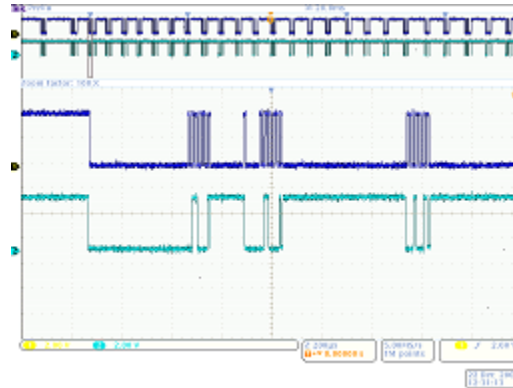

- Use the front-panel ← (previous) and → (next) arrow buttons (arrows around **Set/Clear**) to navigate back and forth between marks instantly.

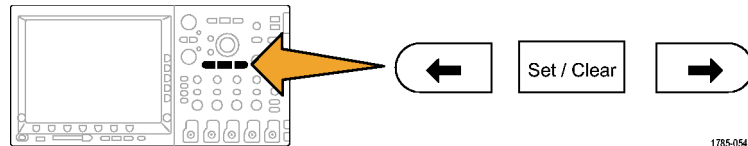

1785-054

11. Push the **Set/Clear** button to remove a mark from the waveform.

The zoom, pan, play/pause, setting/clearing/navigating of marks are all very useful features for *manually* navigating and inspecting the waveform.

**NOTE.** To remove a mark with **Set/Clear**, first center the zoom box on the mark, either with the → and ← arrow buttons, or panning on the mark.

## Demo XI: Using the Wave Inspector's Search Functionality

This section shows how to use the powerful search engine to find events for you.

1. Push the front-panel **Search** button.

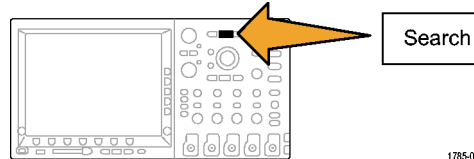

1785-055

2. Push the lower-bezel **Search** button.

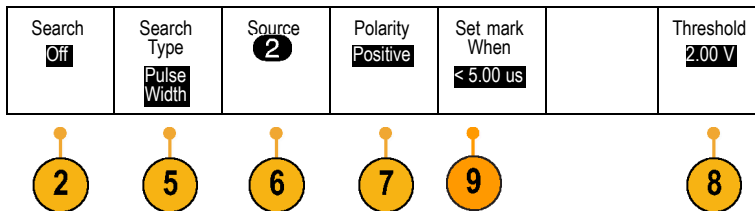

3. Push the side-bezel **Search** button to select **On**.

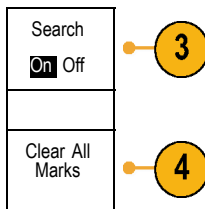

4. Push the side-bezel **Clear All Marks** button.

You are removing the marks that you manually placed on the waveform.

5. Push the lower-bezel **Search Type** button and turn multipurpose knob **a** to select **Pulse Width** from a list of choices.

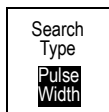

Review all the search choices available and the flexible capability of the your oscilloscope.

6. Push the lower-bezel **Source** button and turn multipurpose knob **a** to select **2** from the list of channels on the screen.
7. Confirm the polarity is positive.

The lower-bezel **Polarity** button should include the word **Positive** below it. If not, push **Polarity** and then the side-bezel **Positive** button.

8. Push the bottom-bezel **Threshold** button.  
Then turn multipurpose knob **a** to set the threshold to approximately the midpoint of the channel 2 waveform (e.g. 2.00 V).

9. Push the lower-bezel **Set Mark When** button. If it is not already selected, push the side-bezel **Pulse Width < 8.00 ns** button.

On the MSO/DPO2000, use multipurpose knob **b** instead.

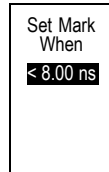

- Using the multipurpose knob **a** on the MSO/DPO4000 or MSO/DPO3000 or **b** on the MSO/DPO2000, change the pulse width to around 2  $\mu\text{s}$ . This is where you should begin seeing marks.

Hint: To get to 2  $\mu\text{s}$  faster, first push the front-panel **Fine** button, if lit, to turn off the Fine function.

Notice both the hollow white triangles placed in the graticule and the number of search events found, shown in the lower left corner of the display. Hollow triangles show search results and solid triangles show user placed marks.

Change the pulse width to 5  $\mu\text{s}$  to show that as you adjust the search criteria, the search results update. Then, change it back down to 2  $\mu\text{s}$ .

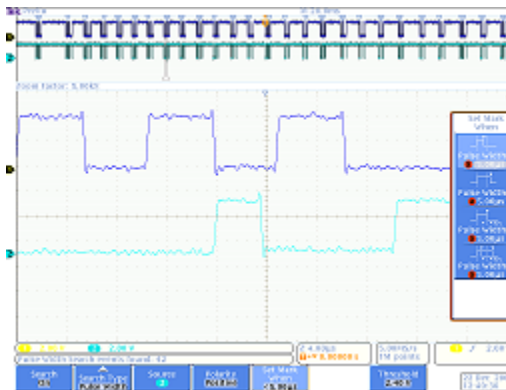

- On the MSO/DPO2000, push **Menu Off** to the right of the display to remove the side menu.

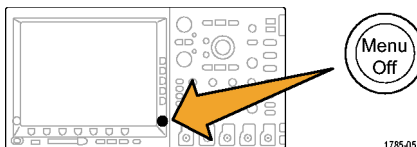

1785-057

12. Jump from mark to mark using the front-panel ← (previous) and → (next) arrow buttons.

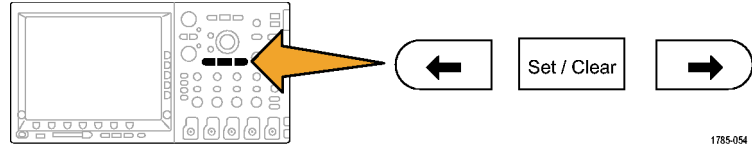

1785-054

13. Turn the zoom (inner) knob, if needed, to zoom in to give you a good view of each pulse that met the criteria. For example, try a zoom factor of 5kX on the MSO/DPO4000 or 1kX on the MSO/DPO2000 and MSO/DPO3000.

**NOTE.** The oscilloscope displays the zoom value near the top of the display.

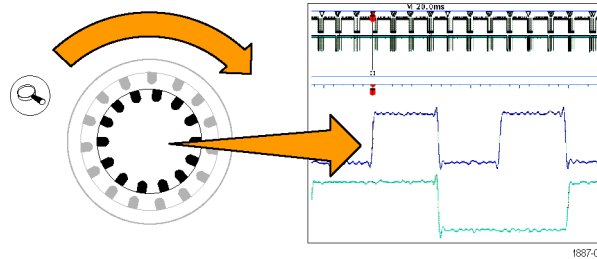

14. When you finish this demo, turn off Search by pushing the lower-bezel **Search** button.

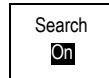

If needed, then push the side-bezel **Search** button so it highlights **Off**.



15. Push **Menu Off** to the right of the display to remove the side menu. Push it again to remove the lower-bezel menu.

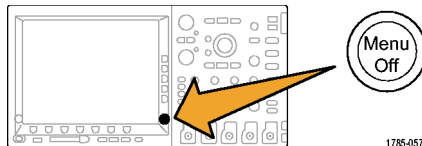

## Demo XII: Using Serial Triggering and Analysis

This demo shows a much easier and more efficient way to analyze your serial buses.

---

**NOTE.** Start from where you finished the last demo.

---

1. Turn the zoom (inner) knob to adjust your zoom factor to 250 X on the MSO/DPO4000 or 200 X on the MSO/DPO2000 and MSO/DPO3000.  
Hint: The oscilloscope will display the zoom value near the top of the display.

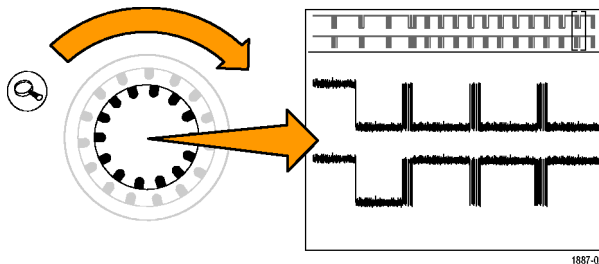



2. Pan the zoom window, as needed.

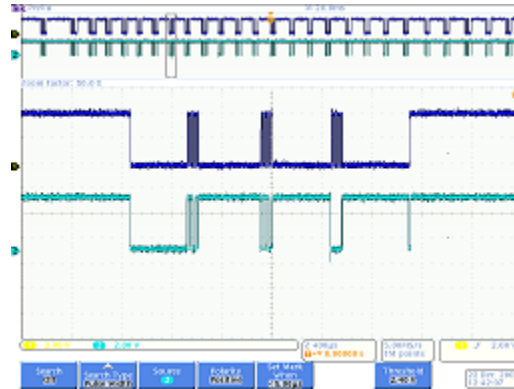

Notice how easy it is to set up a bus on your oscilloscope while you do steps 3 through 9.

3. Push the **B1** button.

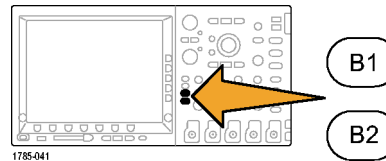

4. Push the lower-bezel **Bus** button and turn knob **a** to scroll through a list of buses that the oscilloscope supports, such as Parallel, I2C, SPI, CAN, and RS-232. Select **I2C**.

Bus B1 <b>I2C</b>	Define Inputs	Thresholds	Include R/W in address <b>No</b>	B1 Label I2C	Bus Display	Event Table
----------------------	---------------	------------	-------------------------------------	-----------------	-------------	-------------

**NOTE.** The specific list of supported buses that you see depends on the model of oscilloscope used and the application modules installed. The MSO/DPO2000's DPO2EMBD, MSO/DPO3000's DPO3EMBD, and MSO/DPO4000's DPO4EMBD modules support I2C.



5. Push the lower-bezel **Define Inputs** button.

6. On the side-menu, confirm that the SCLK Input is set to channel 1 and that the SDA Input is set to channel 2.

Define Inputs
SCLK Input <b>a 1</b>
SDA Input <b>b 2</b>

7. Push the lower-bezel **Thresholds** button.

8. Turn multipurpose knobs **a** and **b** to set the thresholds at about the midpoint of each waveform.

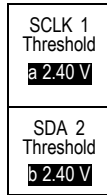

9. Push the front-panel **Menu Off** button once to remove the side menu.

This extremely simple setup procedure (steps 3 through 8) has just enabled you to define and decode a serial bus.

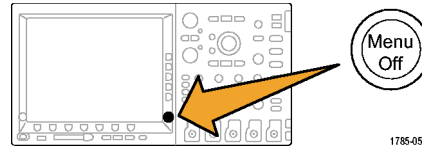

10. Using the pan/zoom controls, zoom in on the different parts of the bus display. Notice what the oscilloscope is showing:

- Start of packet, as indicated by a green vertical bar.
- Address. The yellow box shows the address. **R** is read. **W** is write.
- Data. The blue box shows the Data content.
- Missing Ack, as indicated by a red box with an exclamation point in it.
- Stop (end of packet), as indicated by a red vertical bar.

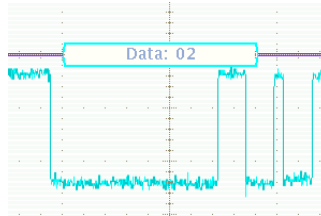
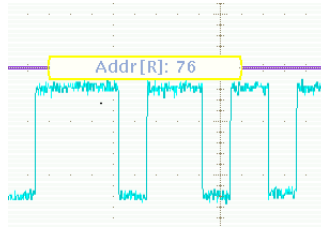

11. Push the lower-bezel **Bus Display** button.

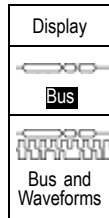

12. Select **Binary** from the side-bezel menu to show that you can decode into either Hex or Binary. Switch back to **Hex**, as it is easier to view.

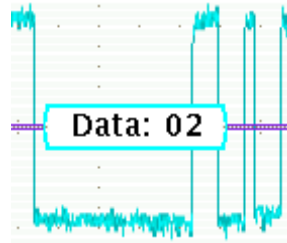
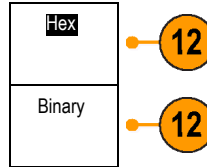

Hex

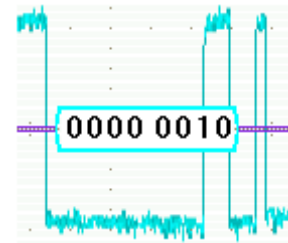

Binary

13. Push the lower-bezel **Event Table** button.

14. Push the side-bezel menu **Event Table** button to select **On**. The event table:

- Is similar to a state listing window in a logic analyzer display,
- Allows you to easily view the contents of every packet captured in the acquisition to trace system activity,
- Includes timestamps for each packet. This makes taking relative timing measurements easy.
- Provides an easy way to view a lot of data on one screen.
- Allows you to save the list in a CSV format

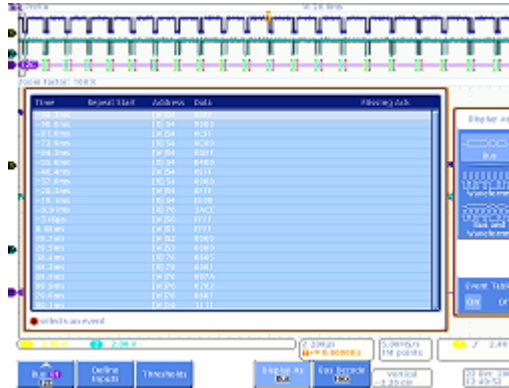

15. Push the side-bezel menu **Event Table** button to select **Off**.



16. There is more to the Tektronix serial solution than just decoding and viewing bus waveforms. There is also triggering and searching.  
Push the front-panel Trigger **Menu** button.

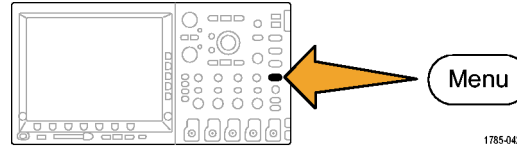

17. Push the lower-bezel **Type** button and turn multipurpose knob **a** to select **Bus**.

Type <b>Bus</b>	Source Bus <b>B1 (I2C)</b>	Trigger On <b>Address</b>	Address <b>50</b>		Direction <b>Write</b>	Mode <b>Normal</b> & Holdoff
--------------------	-------------------------------	------------------------------	----------------------	--	---------------------------	------------------------------------



18. Push the lower-bezel **Source Bus** button and the appropriate side menu button to select the specific bus.

You only have to define a bus once. The rest of the oscilloscope, like the trigger menu, now knows what it is so you do not have to assign channels or thresholds again in this menu.

19. Push the lower-bezel **Trigger On** button.

Notice the list of trigger choices. The key thing is that you can trigger on all the important components of an I<sup>2</sup>C packet. Prior to this, you had to hope that the acquisition you were making contained the data of interest. Now you can guarantee it by specifying the trigger condition.



20. Turn multipurpose knob **a** to select **Address**.
21. Push the lower-bezel **Address** button.
22. The side-bezel **Address** button should already be selected.



23. Turn multipurpose knobs **a** and **b** to enter a hex address of 50.  
While doing this, notice the pre-programmed addresses.

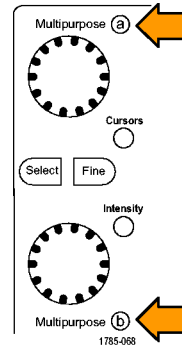

24. Push the lower-bezel **Direction** button.

25. Select the side-bezel **Write** button.

I2C Direction
Read
<b>Write</b>
Read or Write

26. Push **Single** to make an acquisition.

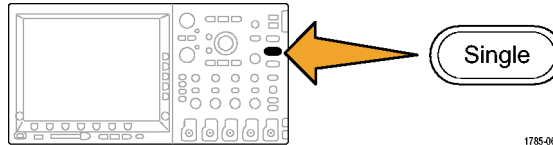

1785-061

27. Turn the zoom (inner) knob to a zoom factor of 100 – 1,000, if needed, so that you can read the bus address values found.
28. Turn the pan (outer) knob to move the zoom box (the gray bars at the top of the screen) to the trigger position icon (the T on an orange background) to reveal what you have triggered on.

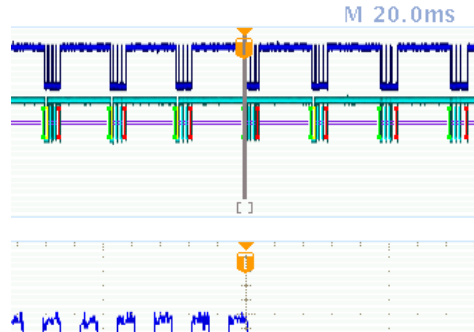

The waveform found illustrates that you have triggered on what you specified.

**NOTE.** *The trigger occurs after all the bits that constitute the search value have gone by.*

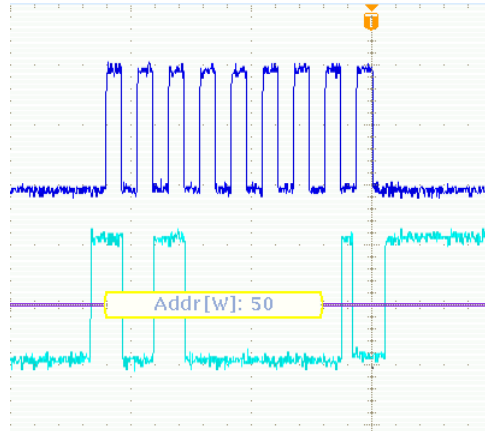

## Demo XIII: Searching Serial Signals

This demo shows how to search on serial bus signals.

1. Push the front-panel Trigger **Menu** button, if not already active. Push the lower-bezel **Type** button and turn multipurpose knob **a** to select **Edge**.

Setting the trigger back to Edge helps return random data for the search exercises described below.

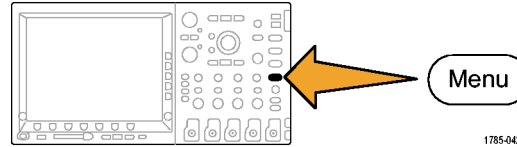

2. Push **Single** to make an acquisition.

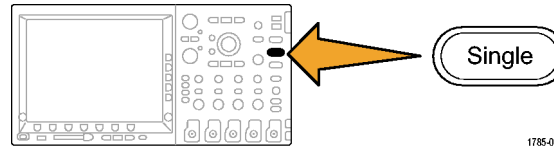

3. Push the front-panel **Search** button.

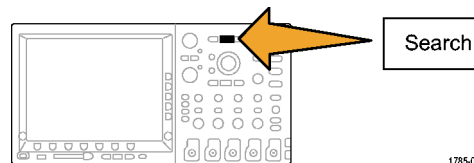

4. Push the lower-bezel **Search** button if the side-menu is not already displayed.
5. Push the side-bezel **Search** button to select **On**.

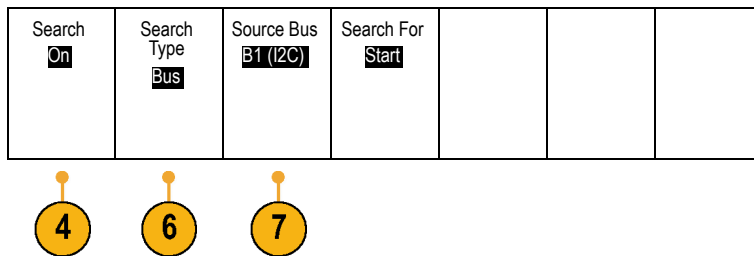

6. Push the lower-bezel **Search Type** button and turn multipurpose knob **a** to select **Bus** from a list of choices.
7. The source bus should already be set to B1. If it is not, push the lower-bezel **Source Bus** button and turn multipurpose knob **a** to select **B1**.  
On the MSO/DPO3000, use the side menu.
8. Push the lower-bezel **Search For** button and turn multipurpose knob **a** to select from all of the criteria that you can search on. Select **Start**.

9. Use the front-panel ← (previous) and → (next) arrow buttons to jump from one mark to the next. This shows how easy it is to move from packet to packet.

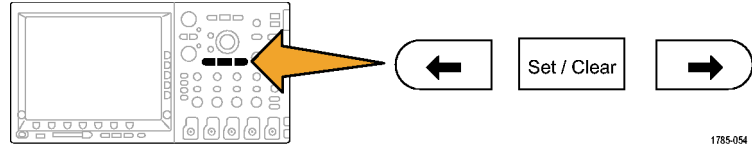

10. Push the lower-bezel **Search For** button (if it is not already active) and select **Address** with multipurpose knob **a**.

11. Push the lower-bezel **Address** button.



- Turn multipurpose knobs **a** and **b** to enter a hex address of **00**.

Notice that there are fewer results now.

Again jump around using the front-panel ← (previous) and → (next) arrow buttons.



- Push the lower-bezel **Search** button and the side-bezel **Save All Marks** button.

Save All Marks

The hollow search marks became filled in. They are now saved. You could run a new search while keeping the old search results marked. Very powerful!



**14.** Notice that Search and Trigger capabilities are very similar.

Triggering is used while running to obtain a stable display and to ensure that the event you are looking for is in the acquisition when you push the front-panel **Run/Stop** button. Triggering does nothing for you after you have stopped acquiring though. That is where search comes in.

Search allows you to find what you are looking for in a mass of data. To make it easier for you to harness the power of both Triggering and Searching, the MSO/DPO2000, MSO/DPO3000, and MSO/DPO4000 series link the two so you can quickly copy your search settings into the trigger engine (usually to acquire new data centered around the event of interest) or copy your trigger settings into the search engine (typically to see if any other trigger events occurred in the acquisition).

## Demo XIV: Monitoring and Decoding RS-232 Signals

All MSO/DPO2000, MSO/DPO3000, and MSO/DPO4000 series oscilloscopes can help you debug RS-232 circuits. They can decode these serial bus transactions into hexadecimal, binary, and ASCII values.

---

**NOTE.** *Install the appropriate DPO2COMP, DPO3COMP, or DPO4COMP application module before running this demo.*

---

1. Attach a probe to channel 1. Then attach it to the Demo 2 board's **GND** point and **RS-232\_TX** signal.

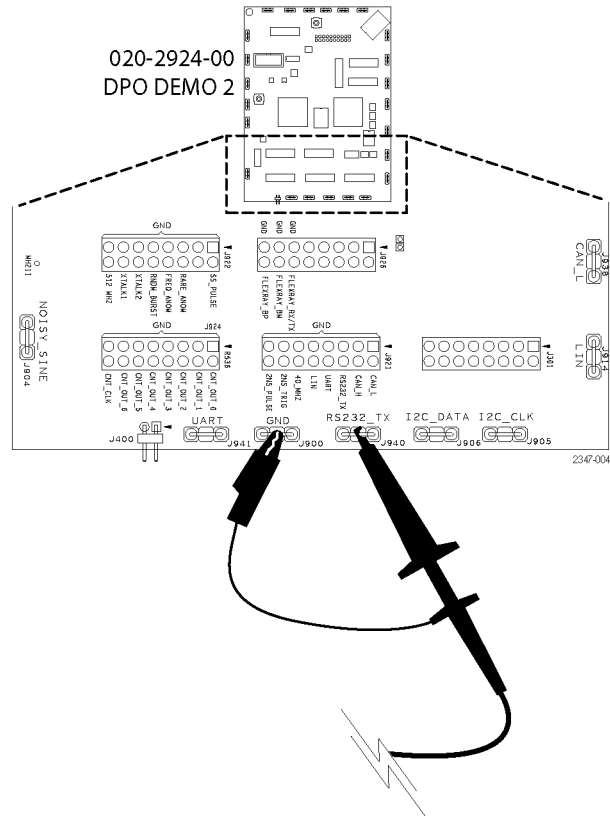

2. Push **Default Setup**.

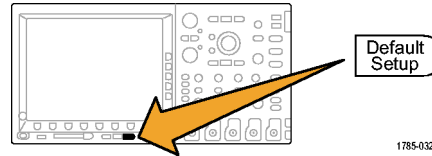

3. Push **Autoset**.

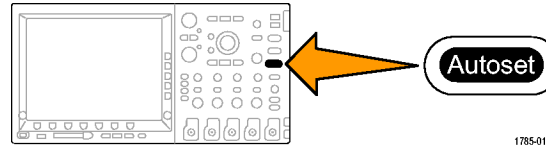

4. Push **Acquire**.

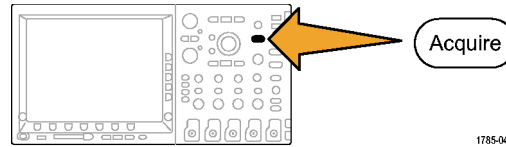

5. Push the lower-bezel menu **Record Length** button (if not already active) and the side-bezel menu **1M points** button.

Mode Sample	Record Length 1M	Reset Horizontal Position	Waveform Display			
----------------	---------------------	---------------------------	------------------	--	--	--



6. Turn the Horizontal **Scale** knob to select a time per division setting of 20 ms.

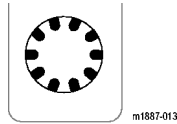

7. Push **B1**.

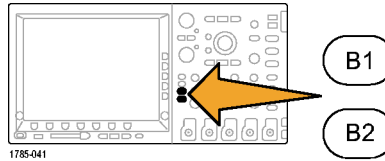

8. Push the lower-bezel **Bus** button.

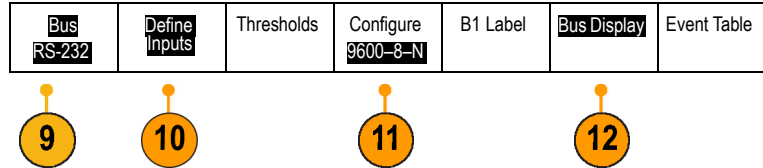

9. Turn multipurpose knob **a** to select **RS-232**.

**NOTE.** *If you do not see the RS-232 choice, check that you have a properly installed the appropriate DPO2COMP, DPO3COMP, or DPO4COMP application module in your oscilloscope.*



10. Push the lower-bezel **Define Inputs** button. Look at the side menu and confirm that channel 1 is set to **Tx Input**. If not, set it there with multipurpose knob **a**.

**NOTE.** *With MSO oscilloscopes, you can select both analog and digital channels to measure TX and RX signals.*

11. Confirm on the lower-bezel **Configure** button that the bit rate is set to 9600. This is the default value.
12. Push the lower-bezel **Bus Display** button and the side-bezel **ASCII** button.

13. Push **Single**.

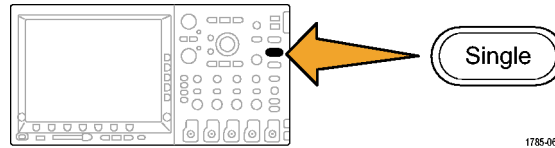

1785-061

14. Turn the zoom (inner) knob of the Wave Inspector to zoom in on the decoded bus display until you can read the ASCII characters (e.g. 10 X).

Notice that each box contains a character.

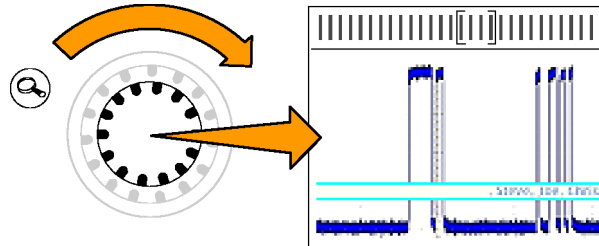

1887-024



2121-232

15. Push the Wave Inspector play button to have the oscilloscope scroll through the message so you can see what it says. Push the play button again to stop the scrolling.

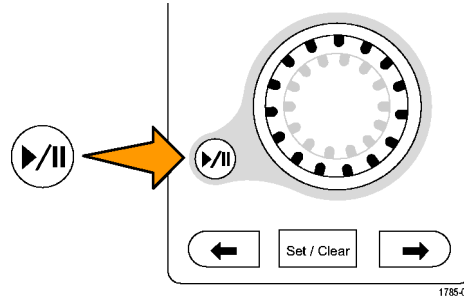

16. Turn off zoom by pressing the front-panel zoom button.

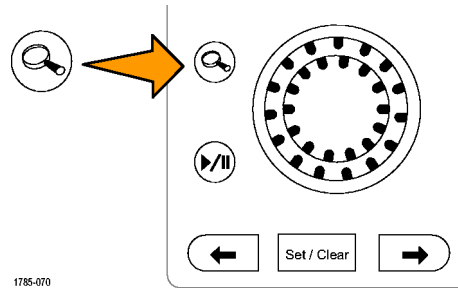

17. Push the lower-bezel **Event Table**.

18. Push the side-bezel **Event Table** button to select **On**.

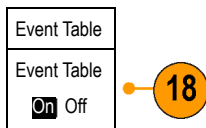

The event table presents information in an alternative way to the graphical bus waveform display. It resembles a state listing window in a logic analyzer.

Notice that you can now view each character in the listing display.

-88.51ms	T
-85.18ms	e
-81.95ms	k
-78.63ms	t
-75.40ms	r
-72.07ms	o
-68.85ms	n
-65.52ms	i
-62.30ms	x

19. Turn off the event table.



20. Push the lower-bezel **Configure** button. Push the side-bezel **Packets** button to **On**. Then push **Menu Off** once to remove the side menu.

Notice that the messages are all contained in packets for easier reading of the ASCII data.

•Enabling•Innovation•

## Demo XV: Triggering on a Serial Data Pattern (e.g. RS-232)

MSO/DPO2000, MSO/DPO3000, and MSO/DPO4000 series oscilloscopes can trigger on a user-specified serial data pattern, such as you would find in RS-232 data.

**NOTE.** Install the appropriate *DPO2COMP*, *DPO3COMP*, or *DPO4COMP* application module before running this demo.

1. Push Trigger **Menu**.

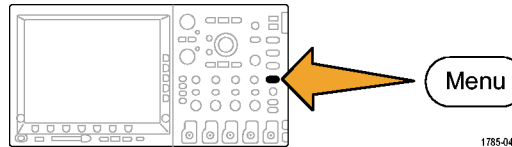

2. Push the lower-bezel **Type** button and select **Bus** with multipurpose knob **a**.

Type Bus	Source Bus B1 RS-232	Trigger On Tx Data	Data 51			Mode Normal & Holdoff
-------------	-------------------------	-----------------------	------------	--	--	-----------------------------

3. Push the lower-bezel **Trigger On** button and use multipurpose knob **a** to select **Tx Data**.



4. Push the lower-bezel **Data** button. Then push the side-bezel **Data** button. Enter the Hex value 54 (ASCII character T) with multipurpose knobs **a** and **b**.

Notice that the side-bezel menu displays the character T for you.

5. Push **Menu Off**.

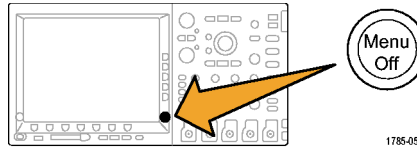

6. Push **Single**.

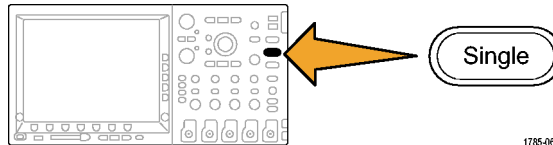

The oscilloscope should now trigger on the letter T (Hex 54). You should see the word "Tektronix" on the display.

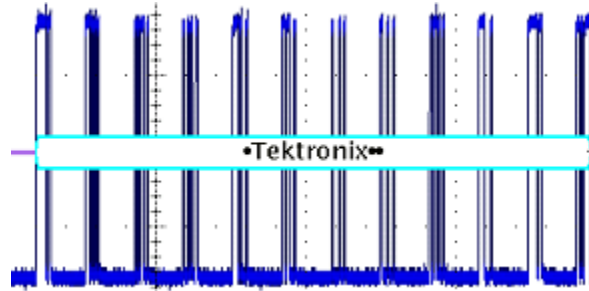

## Demo XVI: FilterVu (MSO/DPO2000)

This demo covers the FilterVu feature of the MSO2000 and DPO2000. FilterVu provides a variable low-pass filter, allowing you to take unwanted noise out of your signal while still capturing high-frequency events such as narrow glitches. It does this by showing two waveforms, a foreground waveform that you can filter and a background, glitch-capture, min-max sampled waveform.

FilterVu's foreground filtered waveform:

- Reveals characteristics of your signal previously overshadowed by noise
- More precisely locates signal edges and amplitude levels, increasing your confidence in cursor measurements
- Blocks out high frequency components of your signal that could cause your oscilloscope to alias

FilterVu's background glitch-capture waveform shows signal attributes up to the full bandwidth of the oscilloscope, enabling you to capture glitches as narrow as 5 ns.

1. Attach a P2221 probe to channel 1 on the MSO/DPO2000 oscilloscope. Then attach the probe to one of the **GND** points and to the **Noisy Sine** signal on the Demo 2 board.

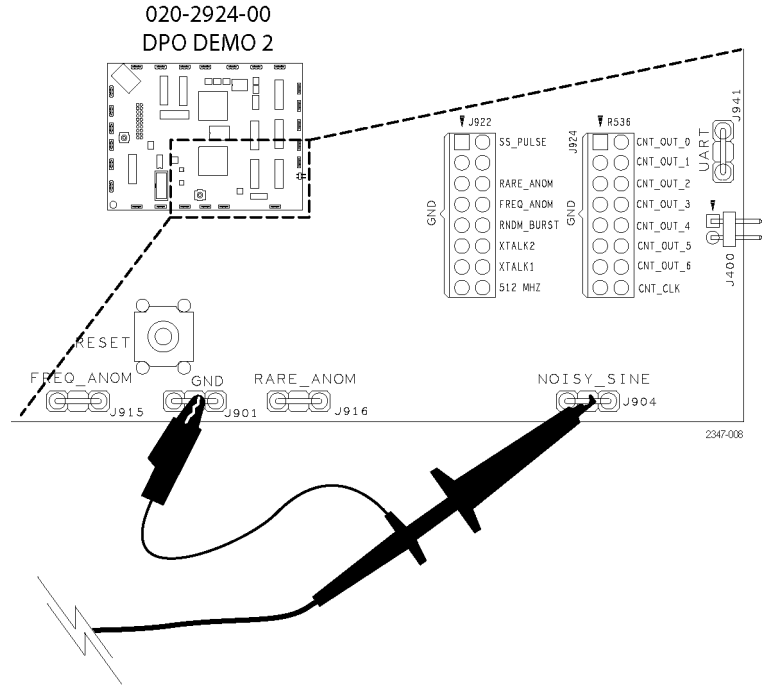

2. Push **Default Setup**.



3. Turn the Horizontal **Scale** to 10 mS/div.

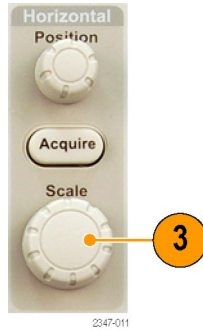

4. Turn the vertical **Scale** knob to 500 mV/div.
5. Adjust the vertical **Position** knob to center the waveform on the screen.

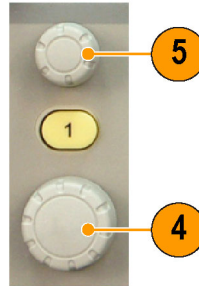

2347-012

6. Turn the Trigger **Level** knob to 1.3 V.



2347-013

You may occasionally notice the waveform bouncing around on the display, seeming to not trigger. Because the waveform that you are looking at has high frequency noise on it, use high frequency reject triggering to have the trigger ignore the noise and obtain a stable waveform. It will provide a stable display without changing how the oscilloscope displays the waveform on the screen.

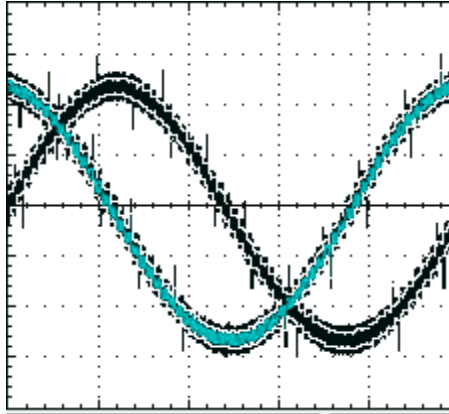

7. Push the front-panel Trigger **Menu** button.

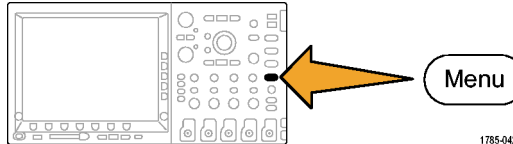

1785-042



8. Press the **Coupling** bottom-bezel button.

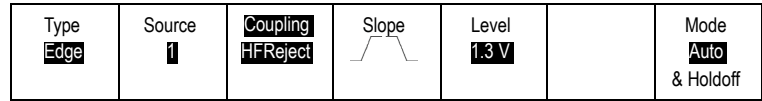

9. Press the **HF Reject** side-bezel button.



The waveform is now stable in the display. This signal represents the output of a DAC. Different voltage levels connected together form the displayed sine waveform. This waveform has noise on it, included glitches that you may see come and go randomly. In order to get a better view of the actual signal and filter out the noise, turn on FilterVu and set the filter value to one that allows the desired waveform shape to come through.

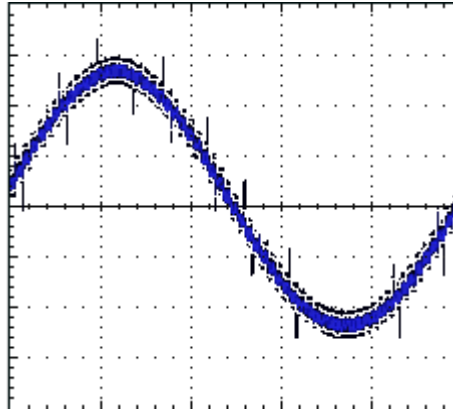

10. Press the front-panel **FilterVu** button.



FilterVu

The low-pass noise filter frequency is initially set to 200 MHz, as shown on the side-bezel menu.

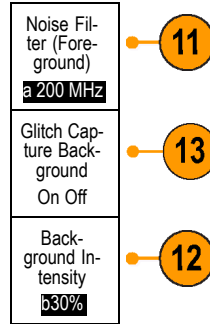

- Change the filter frequency by slowly turning **Multipurpose a** knob counter-clockwise. As you turn it towards the 2.2kHz limit at this horizontal scale setting, you can see the change in the waveform. The yellow foreground waveform now shows the true signal and has the noise filtered out. With this setting, the oscilloscope only passes through frequency content below 2.2 kHz. It filters out the high frequency noise.

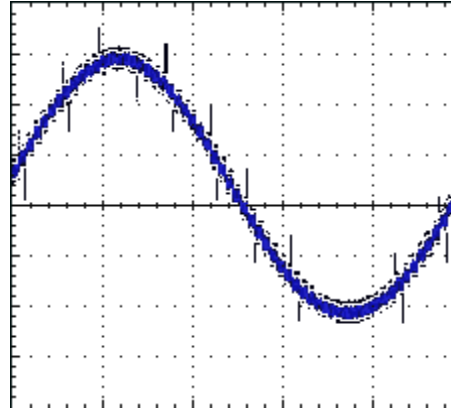

When you change the filter setting, the oscilloscope brightens the amber background trace and shows the random glitches that also occur on the trace along with the noise signature on the waveform. The background trace contains the peak detect information, including transients.

12. Turn **Multipurpose b** clockwise. Change the intensity of the background waveform from 5% to 100% using this control.
13. Turn the background trace off completely by pressing the **Glitch Capture background** side-bezel button.

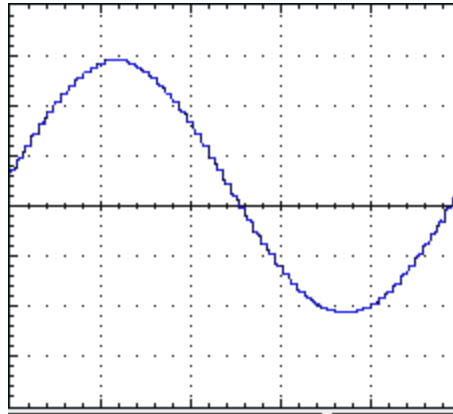

# Giving Demos of MSO Features

The MSO2000, MSO3000, and MSO4000 Series Mixed Signal Oscilloscopes capture and display multiple digital and analog signals.

## Ease of Use

- **Wave Inspector extended to support digital channels:** The MSO models enhance the Wave Inspector to work with its digital channels. The digital channels work with the zoom/pan, play/pause, search and user mark features.
- **Familiar design:** The MSO models work like tools that engineers already know how to use. They possess the look and feel of an oscilloscope and are simple to operate.
- **P6516 Digital Probe:** The MSO4000 works with the P6516 digital probe. This probe has two eight-channel pods. The coax on the first channel of each pod is blue making it easy to identify. The common ground uses an automotive style connector so that customers can easily create their own ground wires for connecting to their device under test. When connecting to square pins, the P6516 has an adapter that can be attached to the probe head, extending the probe ground flush with the probe tip, so that you can attach it to a header.
- **P6316 Digital Probe:** The MSO2000/MSO3000 works with the P6316 digital probe. This probe has two eight-channel pods.
- **Next generation digital waveform display:** The MSO models are designed with color-coded highs, lows, white edge multiple transition indication, gray fuzzy-edge uncertainty indicators, and waveform grouping.

## Performance

- **16 digital channels:** The MSO models add 16 digital channels to the 2 or 4 analog channels found in DPO models.

- **MagniVu (MSO4000/MSO3000):** MagniVu provides timing resolution down to 60.6 ps (MSO4000)/121.2 ps (MSO3000) for 10,000 samples. The maximum MagniVu sample rate is 16.5 GS/s and the record length is 10,000 points centered on the trigger. The main acquisition has a sample rate of 500 MS/s and a record length of up to 10M points. MagniVu is acquired every acquisition. You can switch between the MagniVu record and the main record at any time, running or stopped.
- **Per channel threshold settings (MSO4000):** The MSO4000 allows the user to set a unique logic threshold for each channel. This supports customer designs with multiple logic families, all on the same board.
- **Multiple buses:** The MSO4000 monitors up to four serial or parallel buses simultaneously. The MSO2000/MSO3000 monitors two buses simultaneously.
- **Setup/Hold bus triggering:** The MSO models provide setup/hold time violation triggering across an entire parallel bus, including any or all of the 16 digital channels and the 4 analog ones. You can trigger on all 20 analog and digital channels if you use Aux In as the clock.
- **Parallel bus triggering:** The MSO models add user-defined, logic triggering on a parallel bus. You can assign all of the 4 analog and 16 digital channels to define a logic pattern.
- **Deep memory:** The MSO4000 provides 10 M record length on each of the analog and digital channels, standard on all models. The MSO3000 provides 5 M record length on each channel. The MSO2000 provides 1 M record length on each channel.
- **Waveforms/second:** The MSO4000/MSO3000 provides a 50,000 waveform/second waveform capture rate on the analog channels. The MSO2000 provides a 5,000 waveform capture rate. A higher rate means less dead time and more probability of detecting waveform anomalies.

The MSO models provide parallel bus support. The DPO models do not provide parallel bus support.

All DPO4XXX application modules work with both MSO4000 and DPO4000 models. All DPO3XXX application modules work with both MSO3000 and DPO3000 models. All DPO2XXX application modules work with both MSO2000 and DPO2000 models.

## Tour the MSO Front Panel

- D15-D0 button: Display or remove digital channels from the display, and access the digital channel setup menu
- Bus buttons: Define and display up to four different serial and parallel buses at a time with the MSO4000, and two buses with the MSO2000/MSO3000
- Logic probe connector: Plug the P6316 or P6516 digital probe, with 16 digital connections, into this front-panel receptacle
- Wave Inspector: Extended to support zooming, panning, and searching digital channels

The demo procedures in the sections that follow cover key points of the MSO Mixed Signal Oscilloscopes.

## Demo XVII: Setting up Digital Channels (MSO2000, MSO3000, and MSO4000 Models)

1. Connect the appropriate Digital Probe from the oscilloscope front panel to the counter pins on the Demo 2 board.

For the MSO4000, connect each of the probe's digital group 1 channels D0 to D6 to each of the Demo 2 board's count signals *CNT OUT 0* to *CNT OUT 6*. Connect the probe's D7 channel to the board's *CNT CLK*.

D7 — CNT CLK  
 D6 — CNT OUT 6  
 D5 — CNT OUT 5  
 D4 — CNT OUT 4  
 D3 — CNT OUT 3  
 D2 — CNT OUT 2  
 D1 — CNT OUT 1  
 D0 — CNT OUT 0

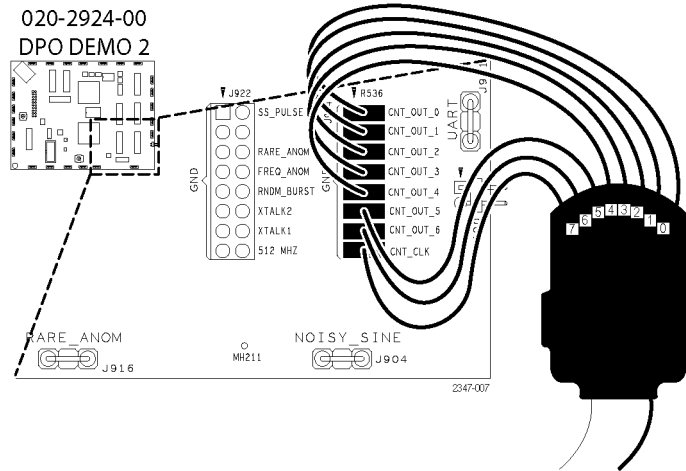



For the MSO4000 and the P6516 digital probe, remember to properly ground each probe pin using the flush mount adapter.

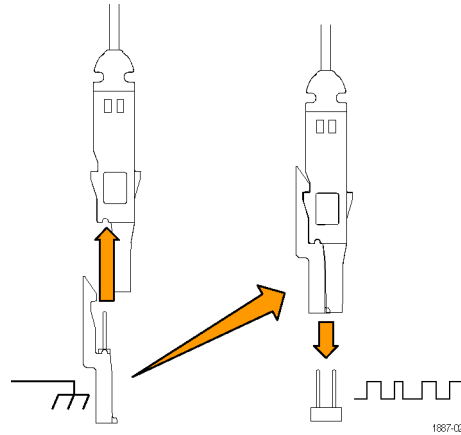

For the MSO2000/MSO3000 and the P6316, simply plug the 16-connector pod into the corresponding 16-pin array on the Demo 2 board. Be sure to line up the eight ground pins on the pod with the corresponding row of eight ground pins on the board.

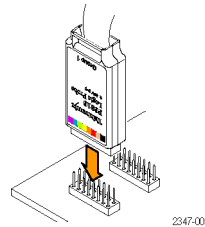

2. Push **Default Setup**.

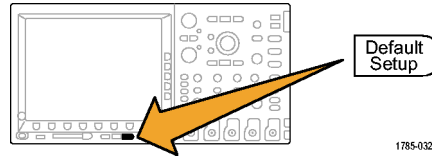

3. Push the front-panel channel 1 button as many times as needed (e.g. two times) to remove the channel 1 waveform from the display.

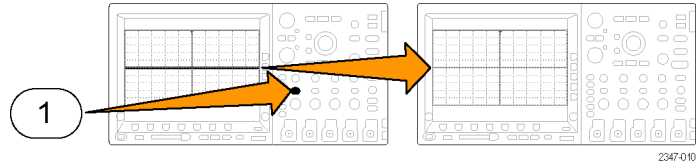

4. Turn the front-panel Horizontal **Scale** knob to set the time/division to 200 ns/div.

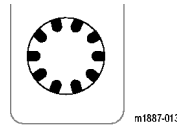

5. Push the front-panel **D15-D0** button.

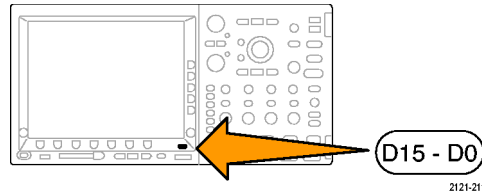

Green

Blue

Notice the green and blue colors of the horizontal portions of the digital channel waveform. The green indicates the signal is at a logic high level and the blue indicates it is at a logic low level.

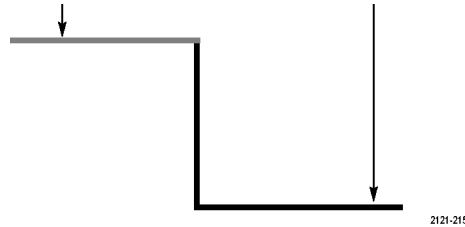

**NOTE.** If you do not see a digital signal on the display, check that you properly connected the digital probe to both the oscilloscope and to the Demo 2 board in step 1.

6. Confirm that the digital waveform height is already set to **M** (medium) on the lower-bezel menu.
7. Push the lower-bezel **D15-D0** menu button (not the front-panel button with the same name). On the resulting side menu, D0 should already be checked as displayed.

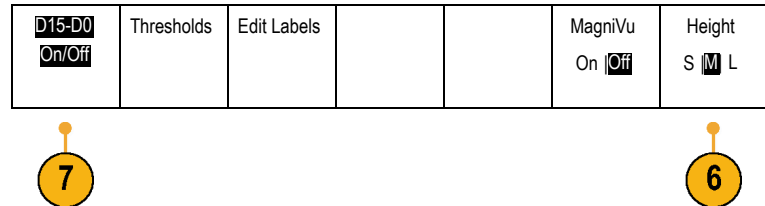

8. Push the side-bezel **Turn On D7-D0** button to turn on the display of channels D0 through D7. Alternatively, you could turn on those channels individually, as shown in steps 9 through 11.

✓	D0	1.40 V
✓	D1	1.40 V
✓	D2	1.40 V
✓	D3	1.40 V
✓	D4	1.40 V
✓	D5	1.40 V
✓	D6	1.40 V
✓	D7	1.40 V

9. Turn multipurpose knob **a** to highlight D1.
10. Push the side-bezel **Display** button to turn on the display of that channel.
11. Push the **Display** button six more times to display channels D2 through D7.

12. Push the front-panel Trigger **Menu** button.

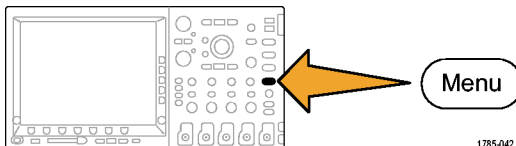

1785-042

13. Push the lower-bezel **Source** button.
14. Turn multipurpose knob **a** to select D7 as the trigger source.

15. Push **Menu Off** to remove the side menu.

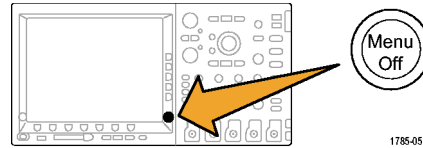

You should now see all seven counter data signals and the counter clock. Notice the upside down triangle on the left side of the display, above the channel 7 marker. This is the channel's group marker.

When multiple channels are placed adjacent to each other on the screen, they form a group.

Groups provide you with an easy way to set up multiple digital channels at once. You can use the group to easily position multiple digital waveforms on the screen. You can also use them to easily alter the voltage thresholds for all the channels in the group.

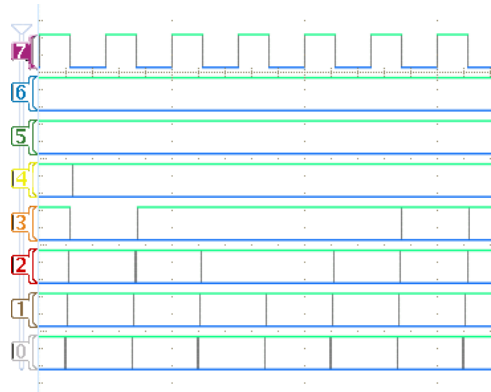

16. Positioning a group of signals on the screen is easy. To demonstrate this, push the front-panel **D15-D0** button, turn multipurpose knob **a** and notice that the oscilloscope highlights each left-side channel marker in turn.

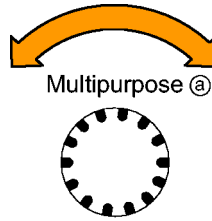

1785-039

As you continue to turn knob **a** after the display highlights the D7 base line indicator and then the right-side D7-D0 channel row, the display highlights the upside-down triangle located above the D7 indicator and it simultaneously highlights all the channel indicators immediately below the triangle.

With the triangle and adjacent channel markers highlighted, turn multipurpose knob **b**. A white outline moves on the left side of the display when you turn the knob. The waveforms themselves move when you stop turning knob **b**.

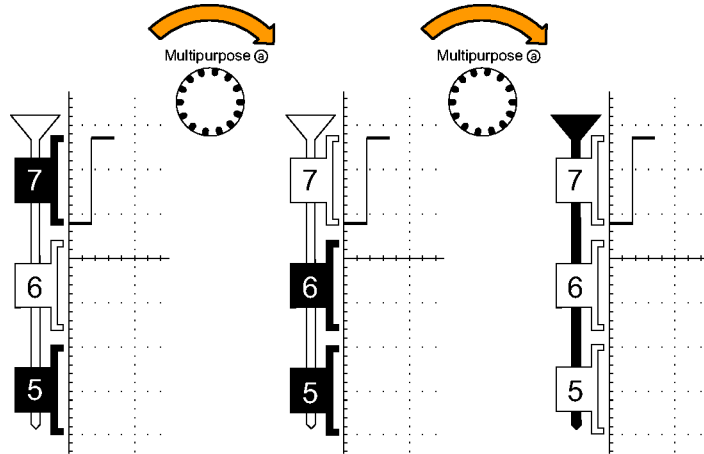

1887-022

To move individual channels, just turn multipurpose knob **a** to highlight the single desired channel and move that channel by turning knob **b**.

If the individual channel is no longer adjacent to the other channels, it is no longer a member of their group. To reconnect it to the group, just move it adjacent to the other waveforms in the group.

### **Demo XVIII: Discovering Per-Channel Thresholds (MSO4000 Only)**

With the MSO4000, you can set a unique logic threshold for each digital channel. This allows for defining different logic high and low voltage levels on different channels. Other oscilloscopes, including the MSO2000/MSO3000, only allow one threshold for eight or more signals.

---

**NOTE.** *Start from where you finished the last demo.*

---

1. Push the front-panel **D15-D0** button, if the lower-bezel D15-D0 menu is not already displayed.

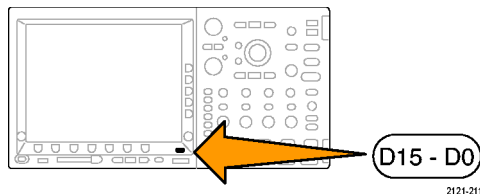

2. Push the lower-bezel **Thresholds** menu button.



Notice that you can set each channel's threshold voltage, individually (MSO4000 only) or as a group, with multipurpose knobs **a** and **b**. For this exercise, leave the thresholds the way they are.

On the MSO2000/MSO3000, you can set the threshold voltage for Group 1 or Group 2.



## Demo XIX: Labeling Channels (MSO2000, MSO3000, and MSO4000 Models)

You can add custom labels to each digital waveform. As the number of signals on the oscilloscope display increases, it becomes more and more helpful to attach labels to each signal.

---

**NOTE.** Start from where you finished the last demo. In other words, you should have pushed the front-panel **D15-D0** button to bring up the D15-D0 lower-bezel menu.

---

1. Connect a USB keyboard to one of the USB ports. Use either the front-panel or, if available, a rear-panel USB port.

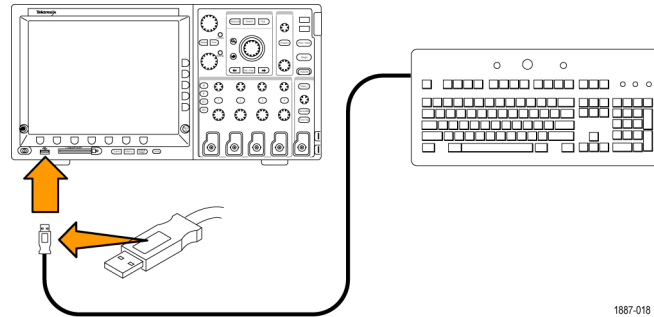

1887-018

2. Push the lower-bezel **Edit Labels** menu button.

D15-D0 On/Off	Thresholds	Edit Labels			MagniVu On <input type="checkbox"/> Off	Height S <input type="checkbox"/> M <input type="checkbox"/> L
------------------	------------	-------------	--	--	--	---



3. Use the keyboard to add labels for channels D0 through D6. Call them Count 0, Count 1, Count 2, Count 3, Count 4, Count 5, and Count 6. Use the keyboard's Enter key or the side menu's down arrow key to select the next channel to label.

Alternatively, you can add a label by pressing **Select Preset Label**, then turning multipurpose knob **b** to select a preset label from a list, and pressing the side menu **Insert Preset Label** button. Try this out by adding the preset label **CLOCK** to D7.

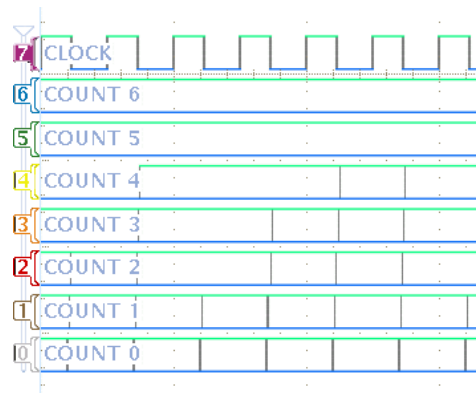

4. When done, push **Menu Off** and admire your list of labels on the screen.

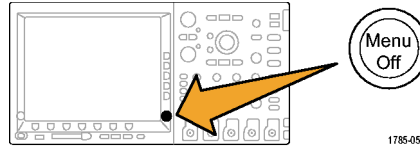

## Demo XX: Exploring Parallel Buses (MSO2000, MSO3000, and MSO4000 Models)

All MSO4000, MSO3000, and MSO2000 series oscilloscopes are designed to efficiently analyze parallel buses, such as those used in embedded circuits. The MSO's bus, triggering, and searching capabilities all support parallel bus analysis.

1. Push the **B1** button.

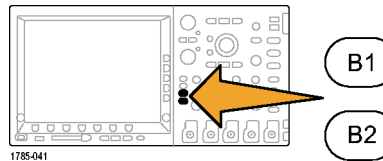

2. Confirm that the selected bus is defined as **Parallel**.

If not, push the lower-bezel **Bus** button and turn multipurpose knob **a** to select **Parallel**.

3. Select **Define Inputs** from the lower-bezel menu.

Bus B1 Parallel	Define Inputs	Thresholds		B1 Label Parallel	Bus Display	Event Table
--------------------	------------------	------------	--	----------------------	-------------	-------------



4. Push the side-bezel **Number of Data Bits** button and enter the number of bits as **7** by turning multipurpose knob **a**.
5. Push the side-bezel **Define Bits** to see a display of which bits are associated with which channels. You can define the inputs with multipurpose knobs **a** and **b**. The channels do not have to be in the same order as the bus. You can select any of the 20 channels to represent the bus. For this exercise, leave D0 as the least significant bit (LSB) and D6 as the most significant bit (MSB).

6. Push **Menu Off** to the lower-right of the display to remove the side menu.

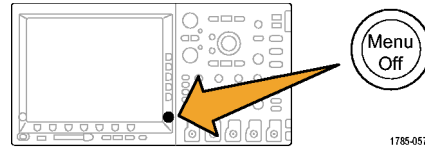

7. Turn knob **a** to move the parallel bus display above the display of digital channels, so you can more easily read the decoded bus.

Observe the decoded bus values on the display. The bus transitions everywhere that the data transitions.

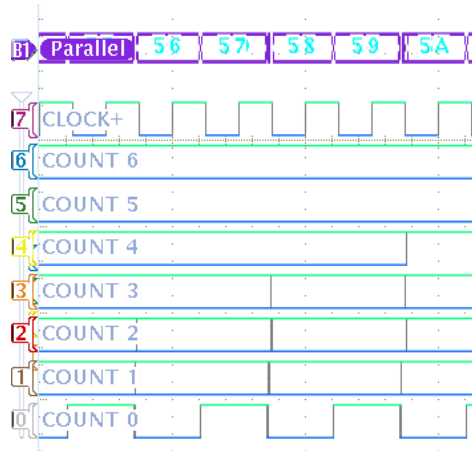

Now let's create a clocked bus.

8. Push **Define Inputs** from the lower-bezel menu.

Bus B1 Parallel	<b>Define Inputs</b>	Thresholds		B1 Label	Bus Display	Event Table
--------------------	--------------------------	------------	--	----------	-------------	-------------



9. Push the side-bezel **Clocked Data** button to select **Yes**.
10. Confirm that the side-bezel **Clock Edge** button is set to the rising edge icon.
11. Confirm that the side-menu **Number of Data Bits** button is still set to 7.
12. Push the side-menu **Define Bits** button (if not already active). Confirm that the source type is set to **Clock**. If not, turn **a** to select it. Turn multipurpose knob **b** to select **D7** as the clock source.

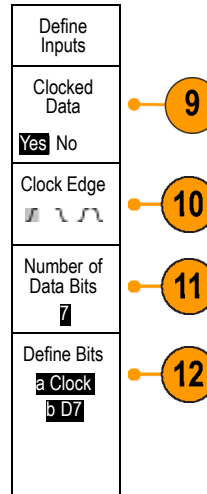

13. Push **Menu Off** to the lower-right of the display to remove the side menu.

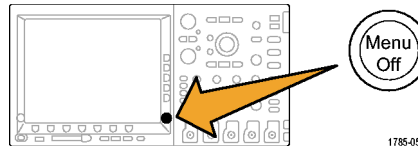

- Take another acquisition by pressing the **Single** button.

Notice that the oscilloscope decodes the bus every time it sees a rising clock edge.

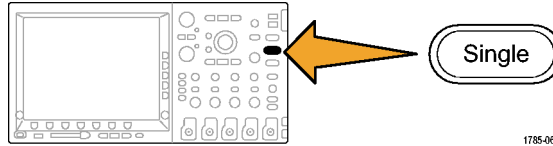

1785-061

- Push the lower-bezel **Event Table** button. Push the side-bezel **Event Table** button select **On**.

Notice that each data value in the table is displayed with its associated time stamp. MSO oscilloscopes can export these values to a CSV file.

Time	Data
-1.900µs	2D
-1.800µs	2E
-1.700µs	2F
-1.600µs	30
-1.500µs	31
-1.400µs	32
-1.300µs	33
-1.200µs	34
-1.100µs	35
-1.000µs	36
-900µs	

- Push **Event Table** to **Off**.
- Push **Menu Off**.

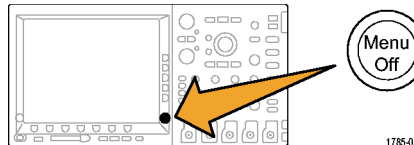

1785-057



## Demo XXI: Triggering on Parallel Bus Data Values (MSO2000, MSO3000, and MSO4000 Models)

The MSO4000, MSO3000, and MSO2000 can trigger on specific parallel bus data values.

1. Push the front-panel Trigger **Menu** button.

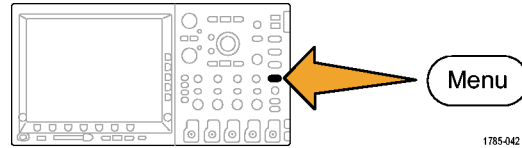

2. Push the lower-bezel **Type** button.

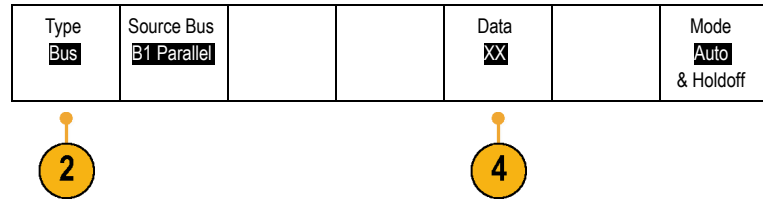

3. Turn multipurpose knob **a** to select **Bus**.

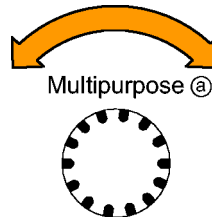

1785-039

4. Push the lower-bezel **Data** menu button.
5. Turn multipurpose knobs **a** and **b** to enter a value of 7F in Hex (all 1's in Binary). You are measuring a counter. The oscilloscope will trigger when the counter reaches a state where all channels reach the 1 state (green).

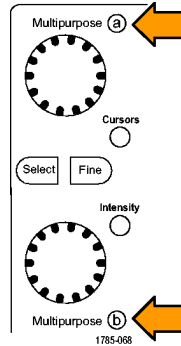

6. Push **Menu Off**.

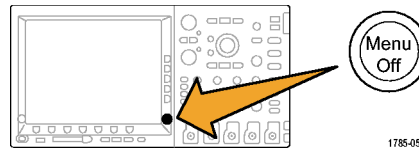

7. Push the front-panel **Run/Stop** button.

Notice that the oscilloscope triggers when the 7F (the all 1's, green) data value you selected above occurs. Triggering on a data pattern is a common request from engineers working on embedded designs.

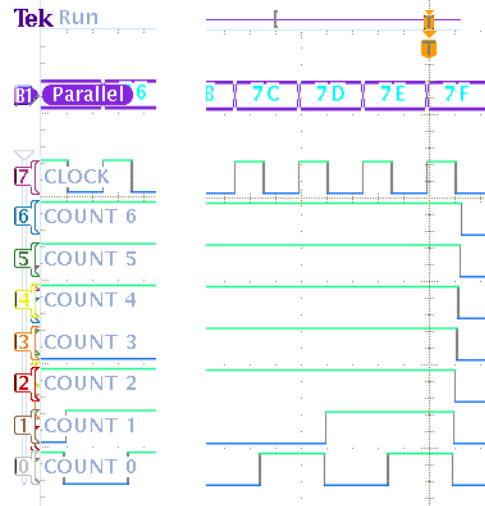

## Demo XXII: Searching for Parallel Bus Data Values (MSO2000, MSO3000, and MSO4000 Models)

The MSO4000, MSO3000, and MSO2000 can search a parallel bus for values that you specify.

1. Push the front-panel **Search** button.

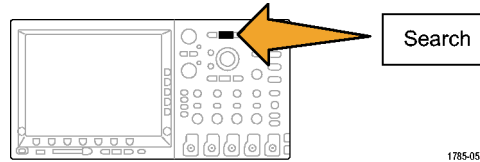

2. Push the lower-bezel **Search** button and the side-bezel **Search** button to turn search to **On**.

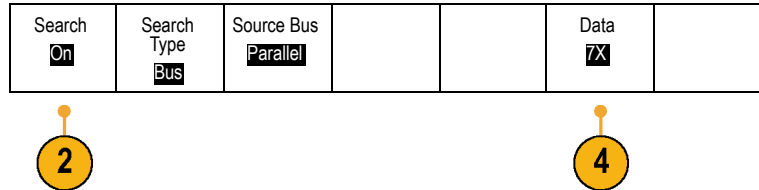

3. Select the side-bezel **Copy Trigger Settings to Search**.

The trigger settings used in the previous demo are now your search criteria. Note that any white diamonds on the top of the display depict each incidence of the search value found in the record.

4. Push the lower-bezel **Data** button. Use the multipurpose **a** and **b** knobs to change the data value to **7X**. The X value stands for any value and will ensure the search returns as many or more results than did the previous step.

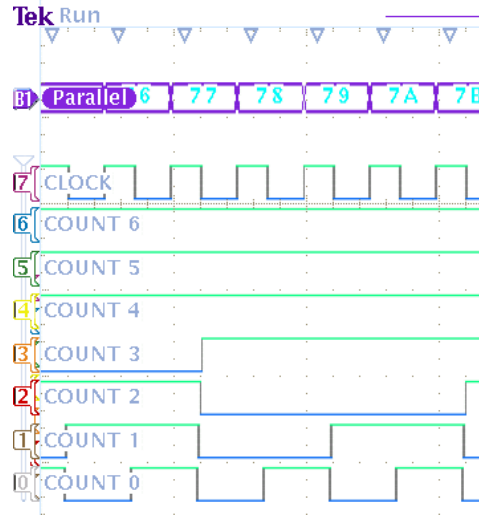

5. Push **Menu Off**.

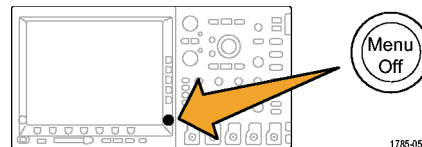

1785-057

### **Demo XXIII: Zooming in on White Edges (MSO4000 Only)**

White vertical edges on displayed digital waveforms inform the user that more information is available at that point in the display. You can zoom in on these white edges to see more details.

---

**NOTE.** *Run this demo with an MSO4104, MSO4054, or MSO4034.*

---

1. Attach a P6139A probe to channel 1 on the MSO4000 oscilloscope. Then attach the probe to one of the **GND** points and to the **XTALK 1** signal on the Demo 2 board.
2. Also attach a P6516 digital probe (D0) to the **XTALK 1** signal.  
You have now attached both the analog and the digital probes to the same test point.

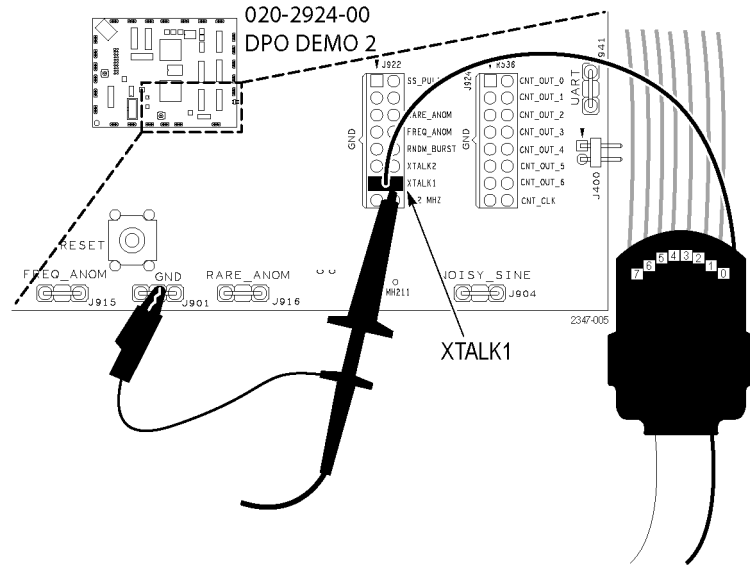

3. Push **Default Setup**.

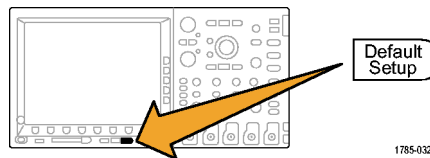

4. Push **Acquire**.

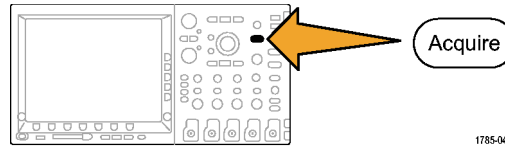

5. Push the lower-bezel menu **Record Length** button (if not already active) and the side-bezel menu **1M points** button.

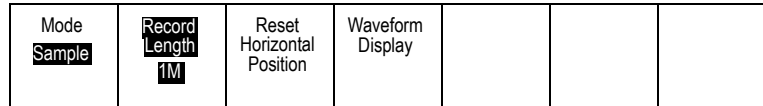

6. Push **D15-D0**.

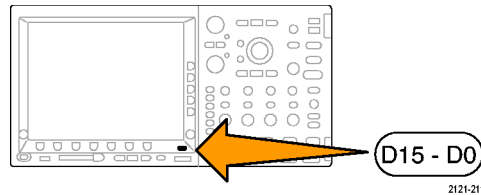



7. Push **Height** to select **L** (large).

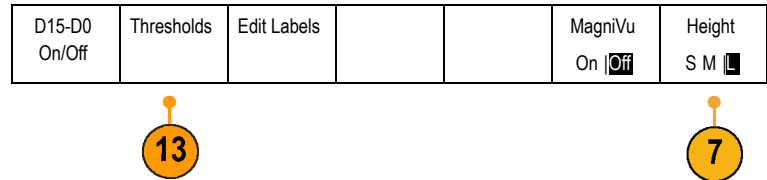

8. Push **Autoset**.

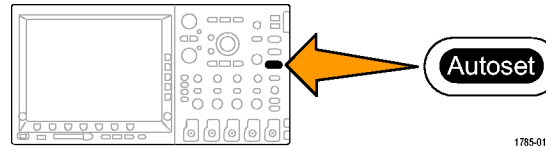

1785-010

9. Turn the Horizontal **Scale** knob to select  $1\ \mu\text{s}$  as the time per division.



m1887-013

10. Turn the channel 1 Vertical **Position** knob to position the analog channel 1 waveform near the middle of the top half of the graticule, if it is not already there.

11. Push **D15-D0**.

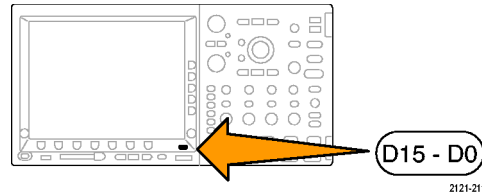

12. Turn multipurpose knob **b** to position the digital channel waveform near the middle of the bottom half of the graticule.
13. Push **Thresholds**. Confirm that **D0** is selected. If not, turn multipurpose knob **a** to select it. Turn multipurpose knob **b** to set the threshold to 1.00 V.

14. Push **Menu Off**.

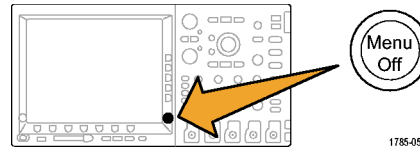

15. Push **Run/Stop**.

Notice any vertical white edges on the digital waveform. If none are visible, push **Run/Stop** again.

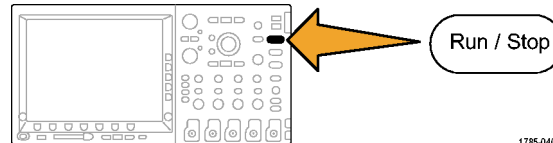

16. As needed, turn the pan (outer) knob and navigate using the zoom window to bring one of the white edges to center screen. Alternatively, push the play button to do this.
17. Turn the zoom (inner) knob of the Wave Inspector to zoom in on one of the white edges. Note you can now see a narrow pulse that you couldn't see before you zoomed in.

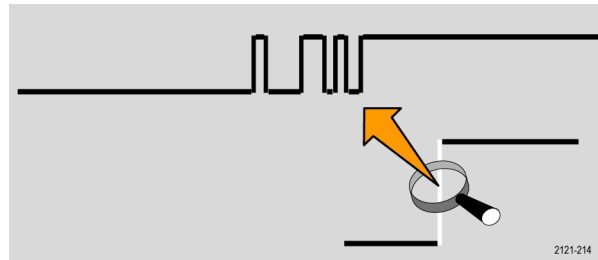
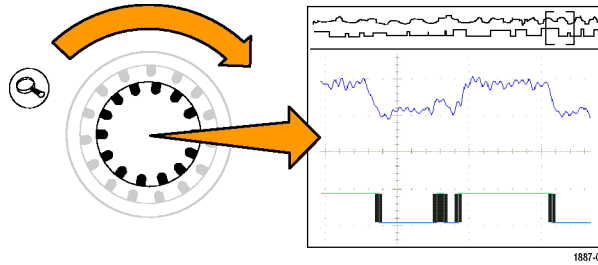

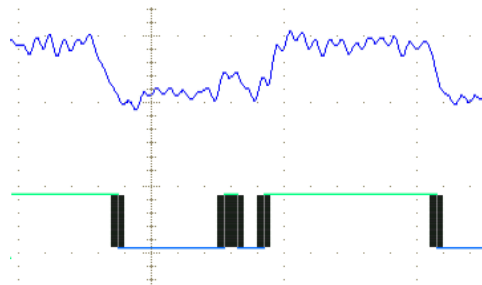

This completes the Tektronix MSO/DPO2000, MSO/DPO3000, and MSO/DPO4000 series demos.

# Troubleshooting

If your Demo 2 board does not appear to work:

## Check the power.

If the Demo 2 board is receiving power, the power indicator will be lighted. If it is not, try gently pushing in the power cable on the USB Device port.

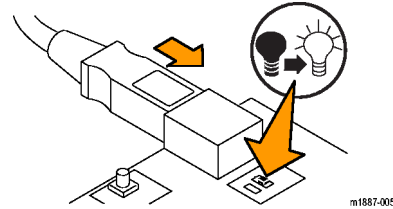

## Locating Signals

The diagram includes a grid to help you locate signal pins on connectors and on headers. To find the desired signal on the diagram, look up the grid location in the signal description, and then use the grid to find that location on the diagram and on the board. (See Figure 1.)

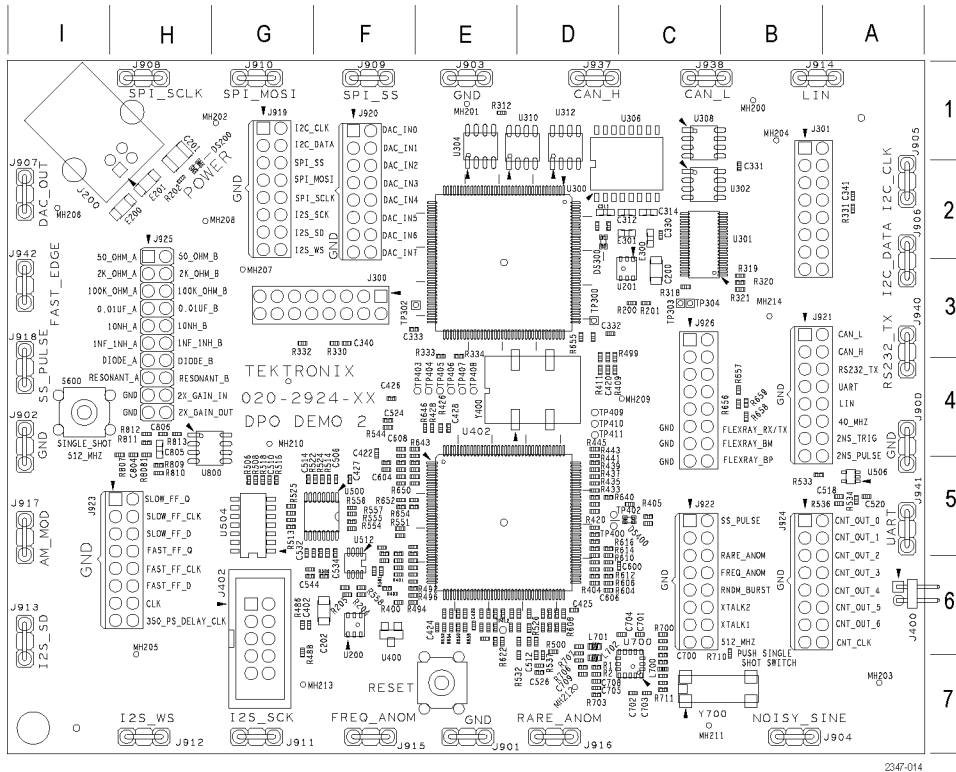

Figure 1: Tektronix Demo 2 board and locator grid

## Noisy Sine

**Board label.** NOISY\_SINE

**Connector grid location.** B7

**Description.** The Noisy Sine signal is an audio frequency (1.25 kHz) sine wave with power supply switching noise style spikes (156 kHz), and very high frequency noise (20 MHz pseudorandom) caused by a micro-controller/DSP system.

## I<sup>2</sup>C Bus

**Board label.** I2C\_CLK, I2C\_DATA

**Connector grid location.** A2, G1

**Description.** These are the I<sup>2</sup>C (Inter-IC Communication) bus signals between the  $\mu$ C and a serial EEPROM.

There are several different types of data packets.

The clock rate is a 100 kHz, 0 to 5 volt signal.

## SPI Bus

**Board label.** SPI\_SCLK, SPI\_SS, SPI\_MOSI

**Connector grid location.** F1, G1, G2, H1

**Description.** These are the SPI (Serial Peripheral Interface) serial bus signals. (See Figure 2.)



The SPI bus signals are set as follows:

- SCLK is the rising edge latch
- SS is active low
- MOSI is active high

This is the beginning of the mixed signal chain. See the descriptions of these signals: DAC Input, Parallel, and DAC Output.

Packets occur approximately every 5 ms. The SPI packet contents are transferred to the Parallel DAC Input bus at the end of the packet. The Parallel DAC Input bus then changes the voltage output of the DAC.

The resulting DAC output is a sine wave with an amplitude of 0 to 3 volts, and a period of 310 ms.

The clock rate is a 100 kHz, 0 to 5 volt signal.

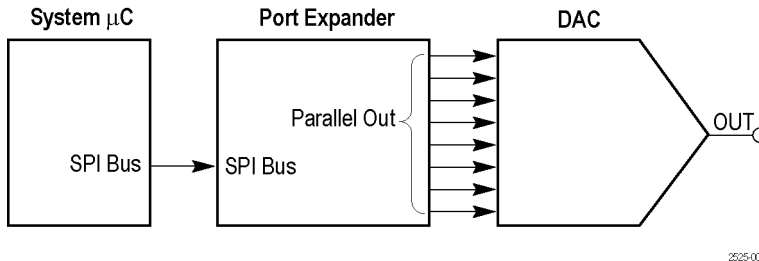

**Figure 2: Mixed signal chain block diagram**

## DAC Input, Parallel

**Board label.** DAC\_IN0: DAC\_IN7

**Connector grid location.** F1, F2

**Description.** These are the 8-bit parallel output signals of the port expander in the middle of the mixed signal chain. The sine wave data from the SPI bus is converted to 8 parallel bits to drive the DAC. DAC IN0 is the LSB. (See Figure 2.)

See the previous SPI Bus description for packet details.

## DAC Output

**Board label.** DAC\_OUT

**Connector grid location.** I2

**Description.** This is the output of the DAC at the end of the mixed signal chain. The DAC is driven from the port expander. The DAC output is a sine wave. Since the output is not filtered, the digitizing levels are obvious in the output waveform. (See Figure 2.)

The resulting DAC voltage is a sine wave with an amplitude 0 to 3 volts, and a period of 310 ms.

## I2S (Inter-IC Sound) Bus

**Board label.** I2S\_SCK, I2S\_WS, I2S\_SD

**Connector grid location.** G2, G7, H7, I6

**Description.** This is an I2S (Inter-IC sound) serial bus.

The clock rate is 2.5 MHz.

## CAN Bus

**Board label.** CAN\_H, CAN\_L

**Connector grid location.** B3, C1, D1

**Description.** These are the CAN (Controller Area Network) bus signals between two CAN transceivers.

The bit rate of the data packet is 500 kbps.

## LIN Bus

**Board label.** LIN

**Connector grid location.** B1, B4

**Description.** This is the LIN (Local Interconnect Network) bus signal between two LIN transceivers.

The bus speed is 19.2 kbaud. The signal contains a mix of version 1.x and 2.x frames.

## RS232 UART, Transmit

**Board label.** RS232\_UART, RS232\_TX

**Connector grid location.** A3, A5, B4

**Description.** The UART signal is the logic level input to the RS-232 UART from the  $\mu$ C. The transmit signal (TX) is the RS-232 voltage level serial bus signal.

The decoded data packets display the ASCII string: Tektronix, Enabling Innovation.

There are no matching receive or data flow control signals.

The baud rate is 9600. The data format is 1 start bit, and 8 data bits with no parity.

## 2 ns Pulse

**Board label.** 2NS\_PULSE

**Connector grid location.** B4

**Description.** This signal is a 2 ns to 3 ns, 2.5 V pulse at a 3.3 ms repetition rate. Use this signal to demonstrate the minimum pulse width capture specification of an instrument's digital acquisition system.

## 2 ns Pulse Trigger

**Board label.** 2NS\_TRIG

**Connector grid location.** B4

**Description.** This is the trigger edge signal for the 2 ns pulse. A falling edge on this signal occurs approximately 1 ns before the 2 ns pulse.

## Crosstalk 1, Crosstalk 2

**Board label.** XTALK1, XTALK2

**Connector grid location.** C6

**Description.** These two signals have significant crosstalk between them. Use them to demonstrate MagniVu.

## Fast Edge

**Board label.** FAST\_EDGE

**Connector grid location.** I3

**Description.** This is a 156 kHz capacitively coupled square wave signal with a 3 ns rise and fall time.

## Fast FF Clock

**Board label.** FAST\_FF\_CLK

**Connector grid location.** H5

**Description.** This is the 1.25 MHz clock input signal to a fast flip-flop.

### **Fast FF Data**

**Board label.** FAST\_FF\_D

**Connector grid location.** H6

**Description.** This is the 1.25 MHz data input signal to a fast flip-flop that is asynchronous to the clock input.

### **Fast FF Q Output**

**Board label.** FAST\_FF\_Q

**Connector grid location.** H6

**Description.** This is the Q output signal of the fast flip-flop. This signal shows metastable behavior infrequently.

### **Slow FF Clock**

**Board label.** SLOW\_FF\_CLK

**Connector grid location.** H5

**Description.** This is the 1.25 MHz clock input signal to a slow flip-flop.

### Slow FF Data

**Board label.** SLOW\_FF\_D

**Connector grid location.** H5

**Description.** This is the 1.25 MHz data input signal to a slow flip-flop that is asynchronous to the clock input.

### Slow FF Q Output

**Board label.** SLOW\_FF\_Q

**Connector grid location.** H5

**Description.** This is the Q output signal of the slow flip-flop. This signal shows metastable behavior frequently.

### Counter Clock

**Board label.** CNT\_CLK

**Connector grid location.** B6

**Description.** This is the 1.25 MHz clock signal for the 7-bit Counter Output described next.

## Counter Output Bits

**Board label.** CNT\_OUT0: CNT\_OUT6

**Connector grid location.** B5, B6

**Description.** These are the 7-bits of the binary counter. The LSB is CNT\_OUT0 at 625 KHz, that is, half of the counter input clock. There are random setup and hold time changes of 500 ps on bits 2 (CNT\_OUT1) and 4 (CNT\_OUT3) of this bus. Use these signals to demonstrate setup time and hold time bus triggering using MagniVu.

The Counter Output Bits and the Counter Clock signals are on eight adjacent sets of header pins for easy connection to a digital probe.

## 350 ps Delayed Clock

**Board label.** 350\_PS\_DELAY\_CLK

**Connector grid location.** H6

**Description.** This is a 156 kHz square wave signal and a delayed copy. Use the nominal 350 ps delay to demonstrate the 60.6 ps timing resolution of the MSO4000.

## Random Burst

**Board label.** RNDM\_BURST

**Connector grid location.** C6



**Description.** This is the signal that produces Bursts of 100 ns wide logic pulses every 6.6 ms. The pattern is a pseudorandom bit sequence that repeats every 128 bursts and has a 6.32  $\mu$ s duration.

## Frequent Anomaly

**Board label.** FREQ\_ANOM

**Connector grid location.** C6, F7

**Description.** There are two frequently occurring anomalies in this pulse train.

A half height runt signal occurs approximately every 104.8 ms. Use a Runt trigger to isolate the signal.

A 50 ns (narrow) pulse appears approximately every 104.8 ms. Use a Pulse Width trigger to isolate the signal.

The pulse train is a repeating group of three pulses. The three pulses are 100 ns, 200 ns, and 100 ns wide, with a 100 ns low between. The group repeats at a 1.6  $\mu$ s rate.

The anomaly is a group of four pulses. The four pulses are 100 ns, 50 ns (narrow), 100 ns (runt), and 100 ns wide, with a 100 ns low between, except for a 50 ns low before the runt.

## Rare Anomaly

**Board label.** RARE\_ANOM

**Connector grid location.** C5, D7

**Description.** There are two less-frequent anomalies in this pulse train that can show up with DPO on DPO3000, MSO3000, DPO4000, and MSO4000 instruments.

A half-height runt signal occurs approximately every 838.8 ms. Use a Runt trigger to isolate the signal.

A 50 ns (narrow) pulse appears in approximately 838.8 ms. Use a Pulse Width trigger to isolate the signal.

The pulse train is a repeating group of three pulses. The three pulses are 100 ns, 200 ns, and 100 ns wide, with a 100 ns low between each pulse. The group repeats at a 1.6  $\mu$ s rate.

The anomaly is a group of four pulses. The four pulses are 100 ns, 50 ns (narrow), 100 ns (runt), and 100 ns wide, with a 100 ns low between each pulse, except for a 50 ns low before the runt.

### 40 MHz

**Board label.** 40\_MHZ

**Connector grid location.** A4

**Description.** This is a 40 MHz square wave signal.

### AM Modulation

**Board label.** AM\_MOD

**Connector grid location.** I5

**Description.** This is a 1.25 MHz carrier amplitude signal modulated by a 1.25 kHz sine wave signal.

The AM Mod signal is centered around ground.

Set the oscilloscope trigger level to either the top or bottom of the waveform to stabilize it on the display.

## Single Shot Pulse

**Board label.** SS\_PULSE

**Connector grid location.** C5, I4

**Description.** This is a 200 ns wide positive pulse that is initiated by the SINGLE SHOT push button (grid location I4). The Demo 2 board provides one pulse per button push.

## 512 MHz

**Board label.** 512\_MHZ

**Connector grid location.** C6

**Description.** This is a 512 MHz, 600 mV peak-to-peak sine wave signal that is enabled by the SINGLE SHOT push button (grid location I4).

## FlexRay

**Board label.** FLEXRAY\_BP, FLEXRAY\_BM, FLEXRAY\_TX/RX

### Connector grid location. C4, C5

**Description.** These FlexRay signals consist of the following test points:

- FlexRay\_BP, the positive half of a differential FlexRay bus
- FlexRay\_BM, the negative half of a differential FlexRay bus
- FlexRay\_Tx/Rx, the single-ended logic signal between the controller and the transceiver

The data rate is at 10 Mb/s. The swing is 0 to 3.3 V. Tri-state is at 1.65 V (BP and BM only). There are 15 individual 198-bit long frames.

### Reset Button

**Board label.** RESET

**Grid location.** E7

**Description.** Press the **RESET** button to start RS-232 signals from a common start point.

### Single Shot Button

**Board label.** SINGLE\_SHOT

**Grid location.** I4

**Description.** Push the **SINGLE SHOT** button to initiate a 200 ns pulse and to enable the 512 MHz signal. The Demo 2 board provides one pulse per button push.