



F R I E D R I C H

OPERATING MANUAL
MODE D'EMPLOI
MANUAL DE FUNCIONAMIENTO

INVERTER
COOLING MODEL

ROOM AIR CONDITIONER
WALL MOUNTED TYPE

Indoor Unit
MW24C3G

Outdoor Unit
MR24C3G

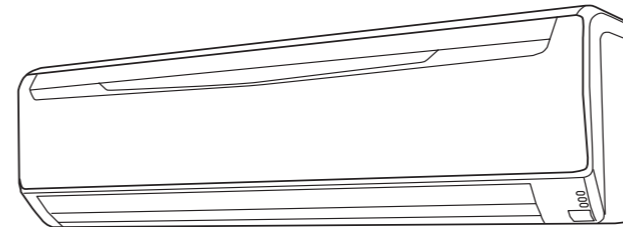

English

Français

Español



F R I E D R I C H

Friedrich Air Conditioning Co.
4200 N. Pan Am
San Antonio, Texas 78218 USA
Tel. (210) 357-4400 Fax (210) 357-4490
Visit us at www.friedrich.com

KEEP THIS OPERATION MANUAL
FOR FUTURE REFERENCE

Friedrich Air Conditioning Co.

P/N9315345370-01

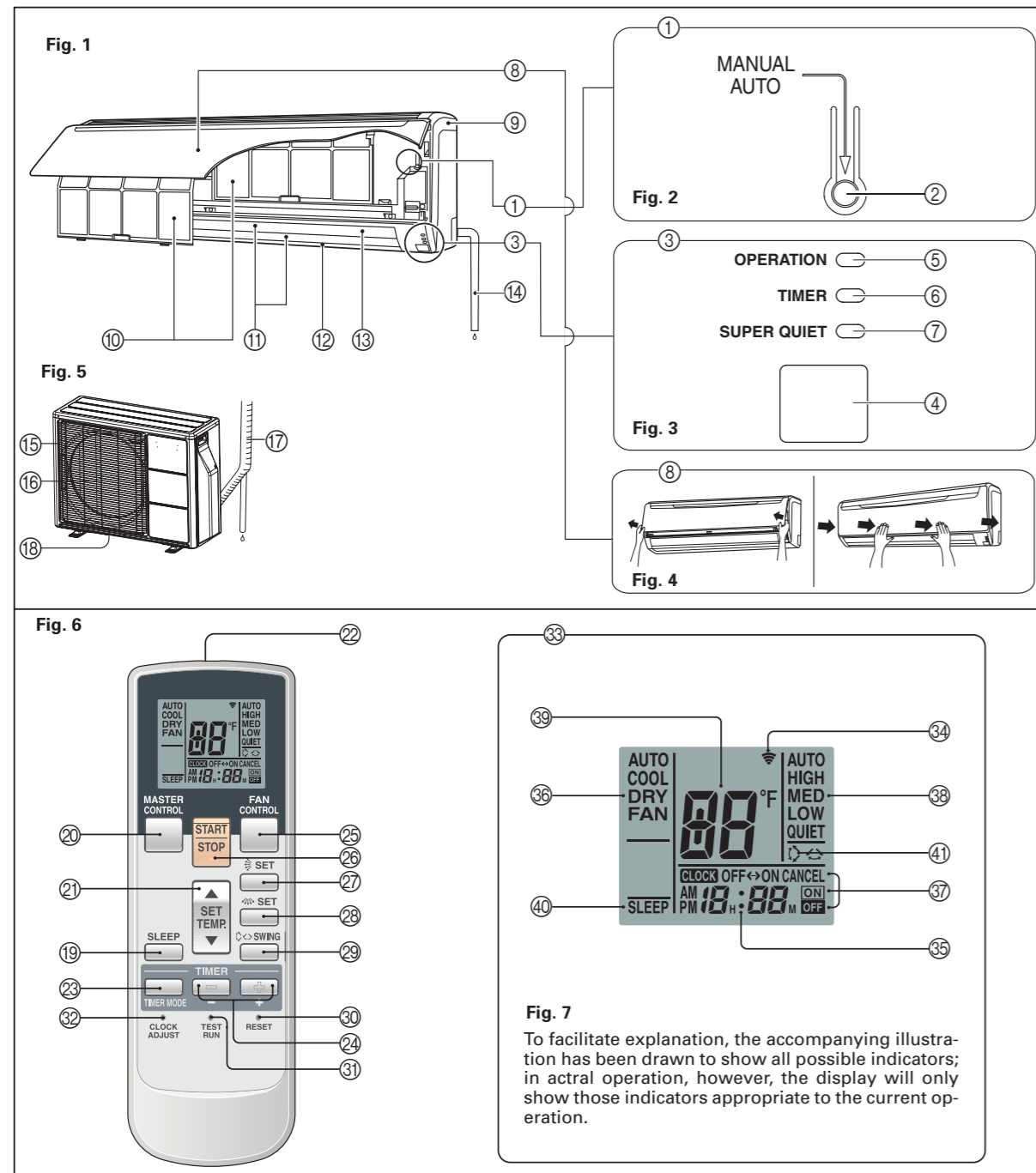

CONTENTS

| | | | |
|------------------------------|------|--|-------|
| SAFETY PRECAUTIONS | En-1 | ADJUSTING THE DIRECTION OF AIR CIRCULATION | En-9 |
| FEATURES AND FUNCTIONS | En-2 | SWING OPERATION | En-10 |
| NAME OF PARTS | En-3 | CLEANING AND CARE | En-11 |
| PREPARATION | En-4 | TROUBLESHOOTING | En-12 |
| OPERATION | En-5 | OPERATING TIPS | En-13 |
| TIMER OPERATION | En-7 | | |
| SLEEP TIMER OPERATION | En-8 | | |
| MANUAL AUTO OPERATION | En-8 | | |

SAFETY PRECAUTIONS



DANGER!

- Do not attempt to install this air conditioner by yourself.
- This unit contains no user-serviceable parts. Always consult authorized service personnel for repairs.
- When moving, consult authorized service personnel for disconnection and installation of the unit.
- Do not become excessively chilled by staying for lengthy periods in the direct cooling airflow.
- Do not insert fingers or objects into the outlet port or intake grilles.
- Do not start and stop air conditioner operation by disconnecting the power supply cord and so on.
- Take care not to damage the power supply cord.
- In the event of a malfunction (burning smell, etc.), immediately stop operation, disconnect the power supply plug, and consult authorized service personnel.



CAUTION!

- Provide occasional ventilation during use.
- Do not direct air flow at fireplaces or heating apparatus.
- Do not climb on, or place objects on, the air conditioner.
- Do not hang objects from the indoor unit.
- Do not set flower vases or water containers on top of air conditioners.
- Do not expose the air conditioner directly to water.
- Do not operate the air conditioner with wet hands.
- Do not pull power supply cord.
- Turn off power source when not using the unit for extended periods.
- Check the condition of the installation stand for damage.
- Do not place animals or plants in the direct path of the air flow.
- Do not drink the water drained from the air conditioner.
- Do not use in applications involving the storage of foods, plants or animals, precision equipment, or art works.
- Do not apply any heavy pressure to radiator fins.
- Operate only with air filters installed.
- Do not block or cover the intake grille and outlet port.
- Ensure that any electronic equipment is at least one metre away from either the indoor or outdoor units.
- Avoid installing the air conditioner near a fireplace or other heating apparatus.
- When installing the indoor and outdoor unit, take precautions to prevent access to infants.
- Do not use inflammable gases near the air conditioner.

| | | |
|--------------------------------------|---|---------|
| TYPE TYPE TIPO | COOLING MODEL MODELE REFRIGERISSANT MODELO DE REFRIGERACION | |
| MODEL MODELE MODELO | INDOOR UNIT UNIDAD INTERIOR UNITE INTERIEURE | MW24C3G |
| | OUTDOOR UNIT UNIDAD EXTERIOR UNITE EXTERIEURE | MR24C3G |
| SPECIFICATIONS | | |
| POWER SUPPLY 208/230 V-60 Hz | | |
| COOLING CAPACITY 24,000 BTU/h | | |
| INPUT POWER 2.4 kW | | |
| CURRENT 10.5 A | | |
| FICHE TECHNIQUE | | |
| ALIMENTATION 208/230 V-60 Hz | | |
| REFROIDISSEMENT 24,000 BTU/h | | |
| PUISSANCE FRIGORIFIQUE 2.4 kW | | |
| PUISSANCE ABSORBEE 10.5 A | | |
| ESPECIFICACIONES | | |
| ALIMENTACION 208/230 V-60 Hz | | |
| REFRIGERACION 24,000 BTU/h | | |
| CAPACIDAD 2.4 kW | | |
| ENTRADA DE ALIMENTACION 10.5 A | | |
| CORRIENTE | | |

FEATURES AND FUNCTIONS

INVERTER

At the start of operation, a large power is used to bring the room quickly to the desired temperature. Afterwards, the unit automatically switches to a low power setting for economic and comfortable operation.

AUTO CHANGEOVER

The operation mode (cooling, dry) is switched automatically to maintain the set temperature, and the temperature is kept constant at all times.

PROGRAM TIMER

The program timer allows you to integrate OFF timer and ON timer operations in a single sequence. The sequence can involve one transition from OFF timer to ON timer, or from ON timer to OFF timer, within a twenty-four hour period.

SLEEP TIMER

When the SLEEP button is pressed during cooling mode, the thermostat setting is gradually raised during the period of operation. When the set time is reached, the unit automatically turns off.

WIRELESS REMOTE CONTROL UNIT

The Wireless Remote Control Unit allows convenient control of air conditioner operation.

HORIZONTAL AIRFLOW

For cooling, use horizontal airflow so the cool air does not blow directly on the occupants in the room.

OMNI-DIRECTIONAL AIR FLOW (SWING OPERATION)

Three-dimensional control over air direction swing is possible through dual use of both an UP/DOWN air direction swing and RIGHT/LEFT air direction swing. Since UP/DOWN air direction flaps operate automatically according to the operating mode of the unit, it is possible to set air direction based on the operating mode.

REMOVABLE OPEN PANEL

The indoor unit's Open Panel can be removed for easy cleaning and maintenance.

MILDEW-RESISTANT FILTER

The AIR FILTER has been treated to resist mildew growth, thus allowing cleaner use and easier care.

SUPER QUIET OPERATION

When the FAN CONTROL button is used to select QUIET, the unit begins super-quiet operation; the indoor unit's airflow is reduced to produce quieter operation.

NAME OF PARTS

Fig. 1 Indoor Unit

- ① **Operating Control Panel (Fig. 2)**
- ② **MANUAL AUTO button**
 - When kept on pressing the MANUAL AUTO button for more than 10 seconds, the forced cooling operation will start.
 - The forced cooling operation is used at the time of installation.
Only for authorized service personnel's use.
 - When the forced cooling operation starts by any chance, press the START/STOP button to stop the operation.

- ③ **Indicator (Fig. 3)**
- ④ **Remote Control Signal Receiver**
- ⑤ **OPERATION Indicator Lamp (red)**
- ⑥ **TIMER Indicator Lamp (green)**
 - If the TIMER indicator lamp flashes when the timer is operating, it indicates that a fault has occurred with the timer setting (See Page 13 Auto Restart).
- ⑦ **SUPER QUIET Indicator Lamp (orange)**

- ⑧ **Intake Grille (Fig. 4)**
- ⑨ **Front Panel**
- ⑩ **Air Filter**
- ⑪ **Air Flow Direction Louver**
- ⑫ **Power Diffuser**
- ⑬ **Right-Left Louver**
(behind Air Flow Direction Louver)
- ⑭ **Drain Hose**

Fig. 5 Outdoor Unit

- ⑮ **Intake Port**
- ⑯ **Outlet Port**
- ⑰ **Pipe Unit**
- ⑱ **Drain port (bottom)**

- Refer to the folded out page on the cover.

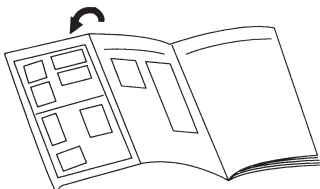

Fig. 6 Remote Control Unit

- ⑲ **SLEEP button**
- ⑳ **MASTER CONTROL button**
- ㉑ **SET TEMP. button (▲ / ▼)**
- ㉒ **Signal Transmitter**
- ㉓ **TIMER MODE button**
- ㉔ **TIMER SET (⊕ / ⊖) button**
- ㉕ **FAN CONTROL button**
- ㉖ **START/STOP button**
- ㉗ **SET button (Vertical)**
- ㉘ **SET button (Horizontal)**
- ㉙ **SWING button**
- ㉚ **RESET button**
- ㉛ **TEST RUN button**
 - This button is used when installing the conditioner, and should not be used under normal conditions, as it will cause the air conditioner's thermostat function to operate incorrectly.
 - If this button is pressed during normal operation, the unit will switch to test operation mode, and the Indoor Unit's OPERATION Indicator Lamp and TIMER Indicator Lamp will begin to flash simultaneously.
 - To stop the test operation mode, press the START/STOP button to stop the air conditioner.
- ㉜ **CLOCK ADJUST button**
- ㉝ **Remote Control Unit Display (Fig. 7)**
- ㉞ **Transmit Indicator**
- ㉟ **Clock Display**
- ㊱ **Operating Mode Display**
- ㊲ **Timer Mode Display**
- ㊳ **Fan Speed Display**
- ㊴ **Temperature SET Display**
- ㊵ **SLEEP Display**
- ㊶ **SWING Display**

PREPARATION

Load Batteries (AAA/R03/LR03 x 2)

- 1 Press and slide the battery compartment lid on the reverse side to open it.**

Slide in the direction of the arrow while pressing the ▼ mark.



- 2 Insert batteries.**

Be sure to align the battery polarities (+/-) correctly.

- 3 Close the battery compartment lid.**

Set the Current time

- 1 Press the CLOCK ADJUST button (Fig. 6 ㉓).**
Use the tip of a ball-point pen or other small object to press the button.

- 2 Use the TIMER SET (+ / -) buttons (Fig. 6 ㉔) to adjust the clock to the current time.**

+ button: Press to advance the time.

- button: Press to reverse the time.

(Each time the buttons are pressed, the time will be advanced/reversed in one-minute increments; hold the buttons depressed to change the time quickly in ten-minute increments.)

- 3 Press the CLOCK ADJUST button (Fig. 6 ㉓) again.**
This completes the time setting and starts the clock.

⚠ CAUTION!

- Take care to prevent infants from accidentally swallowing batteries.
- When not using the Remote Control Unit for an extended period, remove the batteries to avoid possible leakage and damage to the unit.
- If leaking battery fluid comes in contact with your skin, eyes, or mouth, immediately wash with copious amounts of water, and consult your physician.
- Dead batteries should be removed immediately and disposed of properly, either in a battery collection receptacle or to the appropriate authority.
- Do not attempt to recharge dry batteries.

Never mix new and used batteries, or batteries of different types. Batteries should last about one year under normal use. If the Remote Control Unit's operating range becomes appreciably reduced, replace the batteries and press the RESET button with the tip of a ballpoint pen or other small object.

To Use the Remote Control Unit

- The Remote Control Unit must be pointed at signal receiver (Fig. 1 ㉔) to operate correctly.
- Operating Range: About 7 meters.
- When a signal is properly received by the air conditioner, a beeping sound will be heard.
- If no beep is heard, press the Remote Control Unit button again.

Remote Control Unit Holder

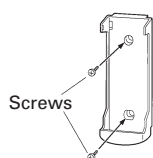

- 1 Mount the Holder.**

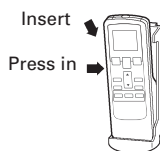

- 2 Set the Remote Control Unit.**



- 3 To remove the Remote Control Unit (when use at hand).**

OPERATION

To Select Mode Operation

- 1 Press the START/STOP button (Fig.6 26).**
The indoor unit's OPERATION Indicator Lamp (red) (Fig. 3 5) will light. The air conditioner will start operating.
- 2 Press the MASTER CONTROL button (Fig.6 20) to select the desired mode.**

Each time the button is pressed, the mode will change in the following order.

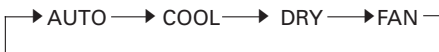

About three seconds later, the entire display will reappear.

To Set the Thermostat

Press the SET TEMP. button (Fig. 6 21).

- ▲ button:** Press to raise the thermostat setting.
- ▼ button:** Press to lower the thermostat setting.

●Thermostat setting range:

| | |
|-------------------|----------|
| AUTO | 64-88 °F |
| Cooling/Dry | 64-88 °F |

The thermostat cannot be used to set room temperature during the FAN mode (the temperature will not appear on the Remote Control Unit's Display).

About three seconds later, the entire display will reappear.

The thermostat setting should be considered a standard value, and may differ somewhat from the actual room temperature.

To Set the Fan Speed

Press the FAN CONTROL button (Fig. 6 25).

Each time the button is pressed, the fan speed changes in the following order:



About three seconds later, the entire display will reappear.

When set to AUTO:

- Cooling :** As the room temperature approaches that of the thermostat setting, the fan speed becomes slower.
- Fan :** The fan runs at the low fan speed.

SUPER QUIET Operation

When set to Quiet:

SUPER QUIET Indicator Lamp (orange) (Fig. 3 7) will light. SUPER QUIET operation begins. The indoor unit's airflow will be reduced for quieter operation.

- SUPER QUIET operation cannot be used during Dry mode. (The same is true when dry mode is selected during AUTO mode operation.)
- During Super Quiet operation, Cooling performance will be reduced somewhat. If the room does not cool down when using SUPER QUIET Operation, please adjust the air conditioner's Fan Speed.

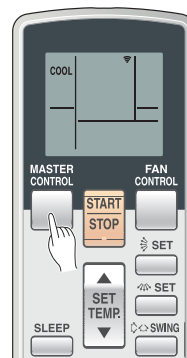

Example: When set to COOL.



Example: When set to 80 °F.

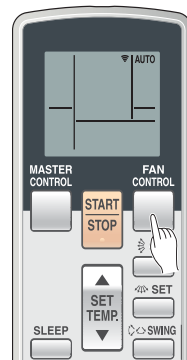

Example: When set to AUTO.



To Stop Operation

Press the **START/STOP** button (Fig. 6 ②⑥).

The OPERATION Indicator Lamp (red) (Fig. 3 ③) will go out.

About AUTO CHANGEOVER Operation

AUTO: ● When AUTO CHANGEOVER operation first selected, the fan will operate at very low speed for about one minute, during which time the unit detects the room conditions and selects the proper operating mode.

If the difference between thermostat setting and actual room temperature is more than +4 °F → Cooling or dry operation

If the difference between thermostat setting and actual room temperature is less than +4 °F → Monitor operation

- When the air conditioner has adjusted your room's temperature to near the thermostat setting, it will begin monitor operation. In the monitor operation mode, the fan will operate at low speed. If the room temperature subsequently changes, the air conditioner will once again select the appropriate operation (Cooling) to adjust the temperature to the value set in the thermostat.

(The monitor operation range is +4 °F relative to the thermostat setting.)

- If the mode automatically selected by the unit is not what you wish, select one of the mode operation (COOL, DRY, FAN).

About Mode Operation

Cooling: ● Use to cool your room.

Dry: ● Use for gently cooling while dehumidifying your room.

- You cannot heat the room during Dry mode.
- During Dry mode, the unit will operate at low speed; in order to adjust room humidity, the indoor unit's fan may stop from time to time. Also, the fan may operate at very low speed when adjusting room humidity.
- The fan speed cannot be changed manually when Dry mode has been selected.

Fan: ● Use to circulate the air throughout your room.

During Cooling/Dry mode:

Set the thermostat to a temperature setting that is lower than the current room temperature. The Cooling and Dry modes will not operate if the thermostat is set higher than the actual room temperature (in Cooling mode, the fan alone will operate).

During Fan mode:

You can not use the unit to heat and cool your room.



TIMER OPERATION

Before using the timer function, be sure that the Remote Control Unit is set to the correct current time (see P. 4).

To Use the ON timer or OFF timer

- 1 Press the **START/STOP** button (Fig. 6 ②) (if the unit is already operating, proceed to step 2). The indoor unit's OPERATION Indicator Lamp (red) (Fig. 3 ⑤) will light.

- 2 Press the **TIMER MODE** button (Fig. 6 ③) to select the **OFF timer or ON timer operation**.

Each time the button is pressed the timer function changes in the following order:

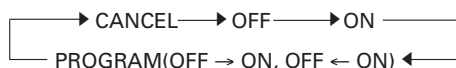

The indoor unit's green **TIMER** Indicator Lamp (Fig. 3 ⑥) will light.

- 3 Use the **TIMER SET** buttons (Fig. 6 ④) to adjust the desired **OFF time or ON time**.

Set the time while the time display is flashing (the flashing will continue for about five seconds).

+ button: Press to advance the time.

- button: Press to reverse the time.

About five seconds later, the entire display will reappear.

To Cancel the Timer

Use the **TIMER** button to select "CANCEL". The air conditioner will return to normal operation.

To Change the Timer Settings

Perform steps 2 and 3.

To Stop Air Conditioner Operation while the Timer is Operating

Press the **START/STOP** button.

To Change Operating Conditions

If you wish to change operating conditions (Mode, Fan Speed, Thermostat Setting, SUPER QUIET mode), after making the timer setting wait until the entire display reappears, then press the appropriate buttons to change the operating condition desired.

To Use the Program timer

- 1 Press the **START/STOP** button (Fig. 6 ②) (if the unit is already operating, proceed to step 2). The indoor unit's OPERATION Indicator Lamp (red) (Fig. 3 ⑤) will light.

- 2 Set the desired times for **OFF timer and ON timer**. See the section "To Use the ON timer or OFF timer" to set the desired mode and times. About three seconds later, the entire display will reappear. The indoor unit's **TIMER** Indicator Lamp (green) (Fig. 3 ⑥) will light.

- 3 Press the **TIMER MODE** button (Fig. 6 ③) to select the **PROGRAM timer operation (OFF → ON or OFF ← ON will display)**.

The display will alternately show "OFF timer" and "ON timer", then change to show the time setting for the operation to occur first.

- The program timer will begin operation. (If the ON timer has been selected to operate first, the unit will stop operating at this point.)

About five seconds later, the entire display will reappear.

About the Program timer

- The program timer allows you to integrate OFF timer and ON timer operations in a single sequence. The sequence can involve one transition from OFF timer to ON timer, or from ON timer to OFF timer, within a twenty-four hour period.
- The first timer function to operate will be the one set nearest to the current time. The order of operation is indicated by the arrow in the Remote Control Unit's Display (OFF → ON, or OFF ← ON).
- One example of Program timer use might be to have the air conditioner automatically stop (OFF timer) after you go to sleep, then start (ON timer) automatically in the morning before you arise.

To Cancel the Timer

Use the **TIMER MODE** button to select "CANCEL". The air conditioner will return to normal operation.

To Change the Timer Settings

1. Follow the instructions given in the section "To Use the ON Timer or OFF Timer" to select the timer setting you wish to change.
2. Press the **TIMER MODE** button to select either OFF → ON or OFF ← ON.

To Stop Air Conditioner Operation while the Timer is Operating

Press the **START/STOP** button.

To Change Operating Conditions

If you wish to change operating conditions (Mode, Fan Speed, Thermostat Setting, SUPER QUIET mode), after making the timer setting wait until the entire display reappears, then press the appropriate buttons to change the operating condition desired.

SLEEP TIMER OPERATION

Unlike other timer functions, the SLEEP timer is used to set the length of time until air conditioner operate is stopped.

To Use the SLEEP Timer

While the air conditioner is operating or stopped, press the SLEEP button (Fig. 6 ⑱).

The indoor unit's OPERATION Indicator Lamp (red) (Fig. 3 ⑤) lights and the TIMER Indicator Lamp (green) (Fig. 3 ⑥) light.

To Cancel the Timer:

Use the TIMER MODE button to select "CANCEL".
The air conditioner will return to normal operation.

To Change the Timer Settings

Press the SLEEP button (Fig. 6 ⑱) once again and set the time using the TIMER SET (+ / -) buttons (Fig. 6 ⑳).

Set the time while the Timer Mode Display is flashing (the flashing will continue about five seconds).

- + button:** Press to advance the time.
- button:** Press to reverse the time.

To Stop the Air Conditioner During Timer Operation:

Press the START/STOP button.

About five seconds later, the entire display will reappear.

About the SLEEP Timer

To prevent excessive cooling during sleep, the SLEEP timer function automatically modifies the thermostat setting in accordance with the set time setting. When the set time has elapsed, the air conditioner completely stops.

During Cooling/Dry operation:

When the SLEEP timer is set, the thermostat setting is automatically raised 2 °F every sixty minutes. When the thermostat has been raised a total of 4 °F, the thermostat setting at that time is maintained until the set time has elapsed, at which time the air conditioner automatically turns off.

SLEEP timer setting

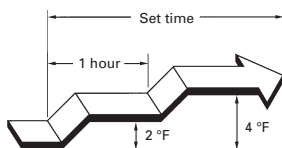

MANUAL AUTO OPERATION

Use the MANUAL AUTO operation in the event the Remote Control Unit is lost or otherwise unavailable.

How To Use the Main Unit Controls

Press the MANUAL AUTO button (Fig. 2 ②) on the main unit control panel.

To stop operation, press the MANUAL AUTO button (Fig. 2 ②) once again.
(Controls are located inside the Open Panel)

- When the air conditioner is operated with the controls on the Main Unit, it will operate under the same mode as the AUTO mode selected on the Remote Control Unit (see page 6).
- The fan speed selected will be "AUTO" and the thermostat setting will be standard.(76°F)



ADJUSTING THE DIRECTION OF AIR CIRCULATION

- Adjust the up, down, left, and right AIR directions with the AIR DIRECTION buttons on the Remote Control Unit.
- Use the AIR DIRECTION buttons after the Indoor Unit has started operating and the airflow-direction louvers have stopped moving.

Vertical Air Direction Adjustment

Press the SET button (Vertical) (Fig. 6 27).

Each time the button is pressed, the air direction range will change as follows:

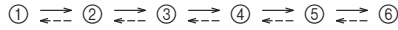

Types of Air flow Direction Setting:

- ①,②,③ : During Cooling/Dry modes
- ①,②,③,④,⑤,⑥ : During Fan mode

The Remote Control Unit's display does not change.

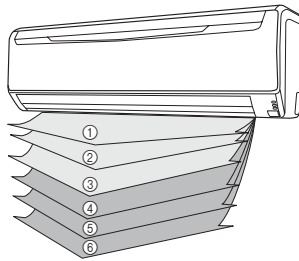

- Use the air direction adjustments within the ranges shown above.
- The vertical airflow direction is set automatically as shown, in accordance with the type of operation selected.
 - During Cooling/Dry mode : Horizontal flow ①
 - During Fan mode : Downward flow ⑤
- During AUTO mode operation, for the first minute after beginning operation, airflow will be horizontal ①; the air direction cannot be adjusted during this period.
- Direction ① ↔ ②
 - Only the direction of the Air Flow Direction Louver changes; the direction of the Power Diffuser does not change.

⚠ DANGER!

- Never place fingers or foreign objects inside the outlet ports, since the internal fan operates at high speed and could cause personal injury.

- Always use the Remote Control Unit's SET button to adjust the vertical airflow louvers. Attempting to move them manually could result in improper operation; in this case, stop operation and restart. The louvers should begin to operate properly again.
- During Cooling and Dry modes, do not move the vertical air direction louvers outside their proper operating range for the mode (① - ③) and into the fan region (④ - ⑥); using the louvers in the fan region will cause moisture to condense near the air outlet, and water may drop onto the floor. During the Cooling/Dry modes, if the louvers are operated outside the range ① - ③ for more than 30 minutes, they will be automatically returned to the ③ range.
- When used in a room with infants, children, elderly or sick persons, the air direction and room temperature should be considered carefully when making settings.

Horizontal Air Direction Adjustment

Press the SET button (Horizontal)(Fig. 6 28).

- Each time the button is pressed, the air direction range will change as follows:



The remote control unit's display does not change.

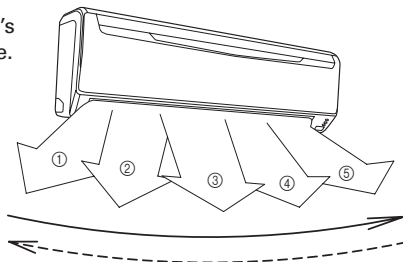

SWING OPERATION

Begin air conditioner operation before performing this procedure.

To select SWING Operation

Press the **SWING** button (Fig. 6 ⑳).

The SWING Display (Fig. 7 ㉑) will light.

Each time the SWING button is pressed, the swing operation will change in the following order.

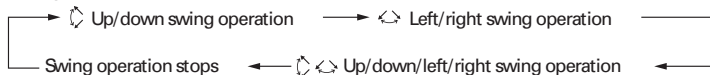

To stop SWING Operation

Press the **SWING** button and select **STOP**.

Airflow direction will return to the setting before swing was begun.

About Swing Operation

- **Up/down swing:** Swing operation begins using the following range according to the current airflow direction.
Airflow direction is 1-4 (for cooling, dry).
With the upper airflow-direction louver in the horizontal position, the lower airflow-direction louver moves (swings) to direct airflow to a wide area.
- **Left/right swing:** The airflow-direction louvers move (swing) in the left/right airflow direction.
- **Up/down/left/right swing:** The airflow-direction louvers move (swing) in both the up/down and left/right airflow directions.
- The SWING operation may stop temporarily when the air conditioner's fan is not operating, or when operating at very low speeds.
- If the SET button (Vertical) is pressed during the up/down swing operation, the up/down swing operation will stop and if the SET button (Horizontal) is pressed during the left/right swing operation, the left/right swing operation will stop.

CLEANING AND CARE

CAUTION!

- Before cleaning the air conditioner, be sure to turn it off and disconnect the Power Supply Cord.
- Be sure the Intake Grille (Fig. 1 ⑥) is installed securely.
- When removing and replacing the air filters, be sure not to touch the heat exchanger, as personal injury may result.

Cleaning the Intake Grille

1. Remove the Intake Grille.

- ① Place your fingers at both lower ends of the grille panel, and lift forward; if the grille seems to catch partway through its movement, continue lifting upward to remove.
- ② Pull past the intermediate catch and open the Intake Grille wide so that it become horizontal.

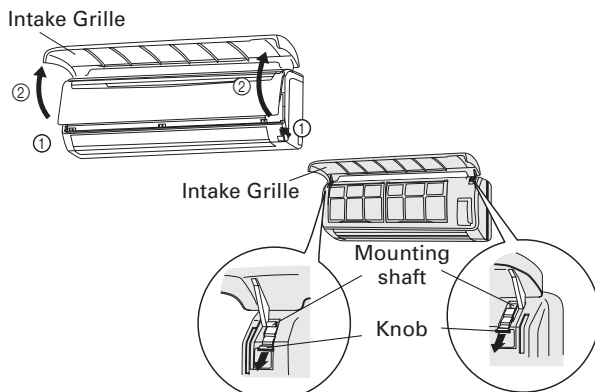

2. Clean with water.

Remove dust with a vacuum cleaner; wipe the unit with warm water, then dry with a clean, soft cloth.

3. Replace the Intake Grille.

- ① Pull the knobs all the way.
- ② Hold the grille horizontal and set the left and right mounting shafts into the bearings at the top of the panel.
- ③ Press the place where the arrow on the diagram indicates and close the Intake Grille.

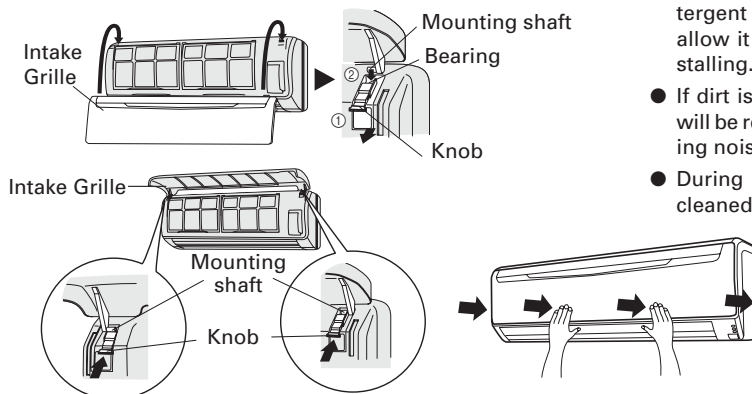

- When used for extended periods, the unit may accumulate dirt inside, reducing its performance. We recommend that the unit be inspected regularly, in addition to your own cleaning and care. For more information, consult authorized service personnel.
- When cleaning the unit's body, do not use water hotter than 104 °F, harsh abrasive cleansers, or volatile agents like benzene or thinner.
- Do not expose the unit body to liquid insecticides or hairsprays.
- When shutting down the unit for one month or more, first allow the fan mode to operate continuously for about one-half day to allow internal parts to dry thoroughly.

Cleaning the Air Filter

1. Open the Intake Grille, and remove the air filter.

Lift up the air filter's handle, disconnect the two lower tabs, and pull out.

Air filter handle



Hooks (two places)

2. Remove dust with a vacuum cleaner or by washing.

After washing, allow to dry thoroughly in a shaded place.

3. Replace the Air Filter and close the Intake Grille.

- ① Align the sides of the air filter with the panel, and push in fully, making sure the two lower tabs are returned properly to their holes in the panel.



Hooks (two places)

- ② Close the Intake Grille.

(For purposes of example, the illustration shows the unit without Intake Grille installed.)

- Dust can be cleaned from the air filter either with a vacuum cleaner, or by washing the filter in a solution of mild detergent and warm water. If you wash the filter, be sure to allow it to dry thoroughly in a shady place before re-installing.
- If dirt is allowed to accumulate on the air filter, air flow will be reduced, lowering operating efficiency and increasing noise.
- During periods of normal use, the Air Filters should be cleaned every two weeks.

TROUBLESHOOTING

WARNING!

In the event of a malfunction (burning smell, etc.), immediately stop operation, turn off the electrical breaker or disconnect the power supply plug, and consult authorized service personnel. Merely turning off the unit's power switch will not completely disconnect the unit from the power source. Always be sure to turn off the electrical breaker or disconnect the power supply plug to ensure that power is completely off.

Before requesting service, perform the following checks:

| | Symptom | Problem | See Page |
|--|------------------------------|---|----------|
| NORMAL FUNCTION | Doesn't operate immediately: | <ul style="list-style-type: none"> ● If the unit is stopped and then immediately started again, the compressor will not operate for about 3 minutes, in order to prevent fuse blowouts. ● Whenever the Power Supply Plug is disconnected and then re-connected to a power outlet, the protection circuit will operate for about 3 minutes, preventing unit operation during that period. | — |
| | Noise is heard: | <ul style="list-style-type: none"> ● During operation and immediately after stopping the unit, the sound of water flowing in the air conditioner's piping may be heard. Also, noise may be particularly noticeable for about 2 to 3 minutes after starting operation (sound of coolant flowing). ● During operation, a slight squeaking sound may be heard. This is the result of minute expansion and contraction of the front cover due to temperature changes. | — |
| | Smells: | <ul style="list-style-type: none"> ● Some smell may be emitted from the indoor unit. This smell is the result of room smells (furniture, tobacco, etc.) which have been taken into the air conditioner. | — |
| | Mist or steam are emitted: | <ul style="list-style-type: none"> ● During Cooling or Dry operation, a thin mist may be seen emitted from the indoor unit. This results from the sudden Cooling of room air by the air emitted from the air conditioner, resulting in condensation and misting. | — |
| | Airflow is weak or stops: | <ul style="list-style-type: none"> ● The fan may operate at very low speed during Dry operation or when the unit is monitoring the room's temperature. | 5 |
| | | <ul style="list-style-type: none"> ● During SUPER QUIET operation, the fan will operate at very low speed. | 5 |
| <ul style="list-style-type: none"> ● In the monitor AUTO operation, the fan will operate at very low speed. | | 5 | |

TROUBLESHOOTING

| | Symptom | Items to check | See Page |
|---|---|--|----------|
| CHECK ONCE MORE | Doesn't operate at all: | <ul style="list-style-type: none"> ● Is the Power Supply Plug disconnected its outlet? ● Has there been a power failure? ● Has a fuse blown out, or a circuit breaker been tripped? | — |
| | | <ul style="list-style-type: none"> ● Is the timer operating? | 7 - 8 |
| | Poor Cooling performance: | <ul style="list-style-type: none"> ● Is the Air Filter dirty? ● Air the air conditioner's intake grille or outlet port blocked? ● Did you adjust the room temperature settings (thermostat) correctly? ● Is there a window or door open? ● In the case of Cooling operation, is a window allowing bright sunlight to enter? (Close the curtains.) ● In the case of Cooling operation, are there heating apparatus and computers inside the room, or are there too many people in the room? | — |
| | | <ul style="list-style-type: none"> ● Is the unit set for SUPER QUIET operation? | 5 |
| The unit operates differently from the Remote Control Unit's setting: | <ul style="list-style-type: none"> ● Are the Remote Control Unit's batteries dead? ● Are the Remote Control Unit's batteries loaded properly? | 4 | |

If the problem persists after performing these checks, or if you notice burning smells, or both the OPERATION Indicator Lamp (Fig. 3 ⑤) and the TIMER Indicator Lamp (Fig. 3 ⑥) flashes, or only the TIMER Indicator Lamp (Fig. 3 ⑥) flashes, immediately stop operation, disconnect the Power Supply, and consult authorized service personnel.

OPERATING TIPS

AUTO Restart

In Event of Power Interruption

- The air conditioner power has been interrupted by a power failure. The air conditioner will then restart automatically in its previous mode when the power is restored.
- Operated by setting before the power failure.
- If a power failure occurs during TIMER operation, the timer will be reset and the unit will begin (or stop) operation at the new time setting. In the event that this kind of timer fault occurs the TIMER Indicator Lamp will flash (see Page. 3).
- Use of other electrical appliances (electric shaver, etc.) or nearby use of a wireless radio transmitter may cause the air conditioner to malfunction. In this event, temporarily disconnect the Power Supply Plug, reconnect it, and then use the Remote Control Unit to resume operation.

OPERATING TIPS

Temperature and Humidity Range

| | Cooling Mode | Dry Mode |
|---------------------|--------------------|--------------------|
| Outdoor temperature | About 14 to 115 °F | About 14 to 115 °F |
| Indoor temperature | About 64 to 90 °F | About 64 to 90 °F |

- If the air conditioner is used under higher temperature conditioner than those listed, the built-in protection circuit may operate to prevent internal circuit damage. Also, during Cooling and Dry modes, if the unit is used under conditions of lower temperature than those listed above, the heat-exchanger may freeze, leading to water leakage and other damage.
- Do not use this unit for any purposes other than the Cooling, Dehumidifying, and air-circulation of rooms in ordinary dwellings.
- If the unit is used for long periods under high-humidity conditions, condensation may form on the surface of the indoor unit, and drip onto the floor or other objects underneath. (About 80% or more).
- If the outdoor temperature is lower than the temperature scope in the list above, in order to keep safety operation of device, the outdoor unit may stop operation for certain period of time.





