

RIKO400

Powerful 400Ws Ring Flash



Instruction Manual

FOREWORD

Before using this product

Please read this user manual carefully in order to ensure your safety and the proper operation of this product. Keep for future reference.

Thank you for purchasing this product.

Powerful Riko400 Ring Flash is the perfect choice for portrait photography, product shooting, photojournalistic and video recording, etc. It can function as ring flash, outdoor flash, as well as LED video light to offer stable light source with high power and great portability. This ring flash offers:

- 400Ws high power, GN36 (m ISO 100)
- Pro 4500mAh Li-ion battery—0.05-2.8s recycle time—approx. 450 full power pops
- 22 steps of precise power control (1/1~1/128)
- Stable color temperature at 5600±200K
- Supports for Multi flash modes, High-Speed Sync, etc.
- Use designed remote control to adjust flash parameters and trigger the flash
- Set as LED video light to offer continuous lighting source

FOR YOUR SAFETY

- ▲ Always keep this product from rain or dampness to avoid fire or electric shock.
- ▲ This product contains high-voltage electronic parts. Touching the high-voltage circuit inside it may result in electric shock. Do not disassemble. Should repairs become necessary, this product must be sent to an authorized maintenance center. Stop using this product if it breaks open due to extrusion, falling or strong hit. Otherwise, electric shock may occur if you touch the electronic parts inside it.
- ▲ Do not fire the flash directly into the eyes (especially those of babies) within short distances. Otherwise visual impairment may occur. When taking pictures for babies, keep the flash unit at least 1 meter (3.3 feet) away from them. Using bounce flash to reduce light intensity is also recommended.
- ▲ Do not use the flash unit in the presence of flammable gases, chemicals and other similar materials. In certain circumstances, these materials may be sensitive to the strong light emitting from this flash unit and fire or electromagnetic interference may result.
- ▲ Do not leave or store the flash unit if the ambient temperature reads over 50°C (e.g. in automobile). Otherwise the electronic parts may be damaged.

- 1 -

Name of Parts

• Body

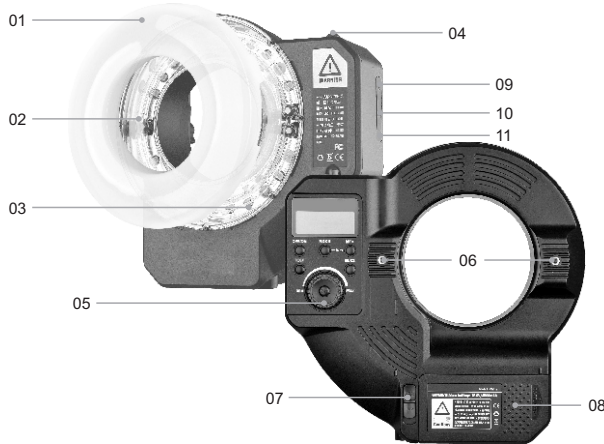

- (1) Diffusion Cover (2) Flash Tube (3) LED Beads (4) Light Sensor (5) Control Panel
 (6) Bracket Mounting Hole (7) Battery Locking Key (8) Battery Pack
 (9) Wireless Control Port (10) Sync Cord Jack (11) PC Sync Socket

• Control Panel

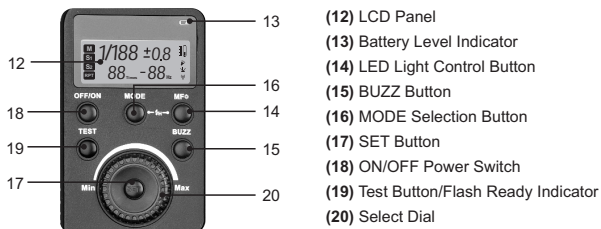

- 2 -

• Brackets

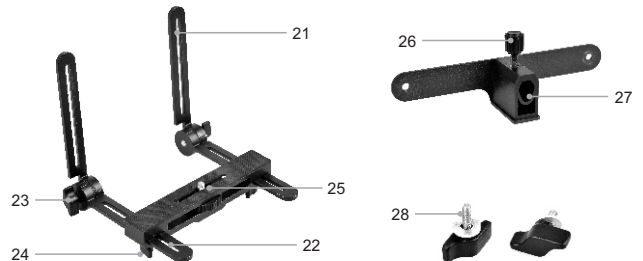

Folding Light Bracket

- (21) Height Guide Rail (22) Depth Guide Rail (23) Angle Adjusting Knob
 (24) Depth Adjusting Knob (25) Camera Adjusting Knob

Umbrella Bracket

- (26) Bolt (27) Umbrella Input (28) Bracket Mounting Bolts

• Included Accessories

- 1*Ring flash 1*Folding light bracket 1*Umbrella bracket 1*Diffusion cover
 1*Battery charger 1*Li-ion Battery pack 1*Instruction Manual

• Separately Sold Accessories

The product can be used in combination with the following accessories sold separately, so as to achieve best photography effects:
 Pro AC Flash Trigger, Photographic Umbrella, Light Stand, etc.

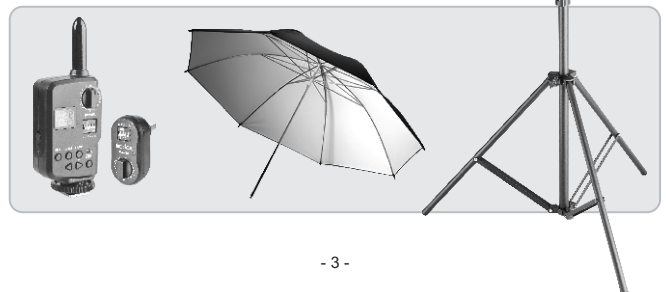

- 3 -

Installation

Installing the Diffusion Cover.

1. Put the diffusion cover on the flash body and make the claws of the cover correctly fall into the hollow periphery of the body.
2. The diffusion cover can be detached by lifting it lightly.



Installing the Camera

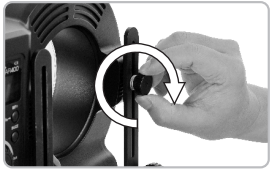

1. Aim the Height Guide Rail (21) at the Bracket Mounting Hole (6) of the flash body. Then, screw the two Bracket Mounting Bolts (28) into the Bracket Mounting Hole (6) and tighten them.

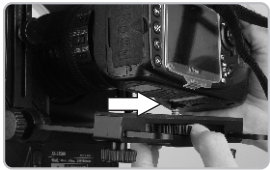

2. Screw the Camera Adjusting Knob (25) into the camera's tripod socket and tighten it.

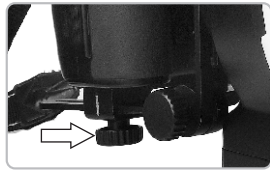

3. Adjust the Angle Adjusting knob (23) to let the camera lens pass through the ring flash.

Installing the Umbrella Bracket

1. Aim the umbrella bracket at the Bracket Mounting Hole (6) of the flash body. Then, screw the two Bracket Mounting Bolts (28) into the Bracket Mounting Hole (6) and tighten them.
2. Insert the photo umbrella.
3. Tighten the bolt to fix the photo umbrella.

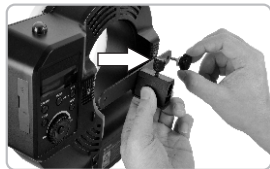

- 4 -

Battery Pack

Features

1. This flash unit uses Li-ion polymer battery which has long runtime. The available charge-and-discharge times are 500.
2. It is reliably safe. The inner circuit is against overcharge, overdischarge, overcurrent, and short circuit.
3. Take only 2.5 hours to fully charge the battery by using the standard battery charger.

Cautions

1. Do not short circuit.
2. Do not expose to rain or immerse into water. This battery is not water proof.
3. Keep out of reach of children.
4. No over 24 hours' continuous charging.
5. Store in dry, cool, ventilated places.
6. Do not put aside or into fire.
7. Dead batteries should be disposed according to local regulations.
8. If the battery had ceased using for over 3 months, please make a full recharge.

Loading and Unloading the Battery Pack

Loading: (1)Put the battery pack into the battery compartment. (2)Push the battery pack to the left until it is locked with a click sound.

Unloading: (1) Push the Battery Locking Key (7) downward. (2) Push the battery pack to the right to unload it.



Battery Level Indication

Battery Level	Battery Level Indication	Flash Times (1/1 step)
Battery Level ≥ 25%	Not Displayed	Approx. 100~400
7% < Battery Level < 25%	Displayed	Approx. 30~100
Battery Level ≤ 7%	Blinking	Approx. < 30

Note: When the LED light is on, the battery voltage is lower and the battery level indicator cannot display the correct amount.

- 5 -

Using the Flash

1. Power Management

Press ON/OFF Power Switch for 2 seconds to power the ring flash on or off. Turn off if it will not be used for an extended period of time.

2. Power Control

The flash output is adjustable from 1/1 full power to 1/128th power in 1/3rd step increments. To obtain a correct flash exposure, use a hand-held flash meter to determine the required flash output.

Turn the select dial to adjust the flash output and the rules are shown in the following table:

Figures displayed when reducing flash output level →

1/1	1/1-0.3	1/1-0.7	1/2	1/2-0.3	1/2-0.7	1/4	...	OF
	1/2+0.7	1/2+0.3		1/4+0.7	1/4+0.3		...	

← Figures displayed when increasing flash output level



When the LCD panel shows "OF", it means that there is no flash output and the flash cannot be fired.

3. M Mode

Press MODE Selection Button (16) to enter M mode. In this mode, you can set the flash unit onto your camera hot shoe or your trigger hot shoe for firing. During shooting, adjust the power output and press the camera shutter, then the camera flash will fire a flash under the camera synchronous signal. In this mode, the light sensor is off.

4. S1 Mode: S1 Slave Triggering Mode

Press Mode Selection Button (16) to enter S1 mode. In this mode, the flash unit can function as a slave flash for creating multiple lighting effects. It is respectively applicable to manual flash environment.

In S1 mode, the flash unit will fire synchronously when the master flash fires, the same effect as that by the use of radio triggers.

5. S2 Mode: S2 Slave Triggering Mode

Press Mode Selection Button (16) to enter S2 mode. In this mode, the flash unit can function as a slave flash for creating multiple lighting effects. It is respectively applicable to TTL system.

In S2 mode, the flash unit will ignore a single "preflash" from the master flash and will only fire in response to the second, actual flash from the master.

6. RPT Mode: Stroboscopic Flash

Press Mode Selection Button (16) to enter RPT mode. With stroboscopic flash, a rapid series of flashes is fired. It can be used to capture multiple images of a moving subject in a single photograph.

You can set the firing frequency (number of flashes per sec. expressed as Hz), the number

- 6 -

of flashes, and the flash output.

For setting procedures, see the following:

- Press the Mode Selection Button (16) so that "RPT" is displayed.
- Press Set Button (17) to select the item to be set. The item blinks.
- Rotate Select Dial (20) to set a desired number.

Calculating the Shutter Speed

During stroboscopic flash, the shutter remains open until the firing stops. Use the following formula to calculate the shutter speed and set it with the camera.

Number of flashes / Firing frequency = Shutter speed

For example, if the number of flashes is 10 and the firing frequency is 5 Hz, the shutter speed should be at least 2 sec.

Note:

- Stroboscopic flash is most effective with a highly reflective subject against a dark background.
- Using a tripod, a remote switch, and an external power source is recommended.
- A flash output of 1/1 or 1/2 cannot be set for stroboscopic flash.
- Stroboscopic flash can be used with "buLb".



To avoid overheating and deteriorating the flash head, do not use stroboscopic flash more than 10 times in succession.

Maximum Stroboscopic Flashes:

Flash Output	Hz						
	1	2	3	4	5	6	7
1/4	30	2	2	2	2	2	1
1/8	50	4	2	2	2	2	2
1/16	70	70	7	4	3	3	3
1/32	80	80	80	16	8	6	5
1/64	99	99	99	99	99	99	25
1/128	99	99	99	99	99	99	99

Flash Output	Hz						
	8	9	10-11	12-13	13-15	15-19	20-99
1/4	1	1	1	1	1	1	1
1/8	2	2	2	2	2	2	2
1/16	2	2	2	2	2	2	2
1/32	5	4	4	3	3	3	3
1/64	15	10	6	6	5	5	5
1/128	99	99	99	99	99	36	20

- 7 -

7. Hi-Speed Sync Triggering

To enter Hi mode, press both Mode Selection Button (16) and LED Light Control Button(14). Press Mode Selection Button (16) again to exit Hi mode.

In Hi hi-speed sync triggering mode, you can use a hi-speed sync trigger to have your flash unit synchronize with all shutter speeds of cameras (max. 1/8000 second, up to your camera). This is convenient when you want to use aperture- priority for fill-flash portraits.

Note:

- Hi-speed sync triggering mode is effective only when the flash unit is used together with hi-speed sync trigger, e.g., PIXAPRO Pro ST-II transceiver.
- Hi-speed sync triggering mode is not available when the flash unit is mounted onto the camera hotshoe.



To avoid overheating or deteriorating the flash head, the over-temperature protection function will be activated automatically after 10 continuous high-speed flashes and the recycle time becomes 10s longer.

Number of flashes that will activate over-temperature protection in high-speed sync triggering mode:

Power Output Level	Number of Flashes (Approx.)
1/1	10
1/2	15
1/4	20
1/8	30
1/16	40
1/32	50

8. LED Light Control

Press the LED Light Control Button (14) to control LED light: Off→30%→70%→100%→Off.....

When the LED light is turned on, the  icon is shown on the LCD display.

Step	Time of Auto off
100%	5 min.
70%	10 min.
30%	15 min.

9. Buzz Function

The buzz function can be controlled by pressing BUZZ Button (15).

When the buzzer is turned on,  is shown on the LCD display.

10. Wireless Control Function

- The flash unit is built in with a Wireless Control Port (9) so that you can wirelessly control the on-and-off of your flash, modeling lamp and buzzer, as well as adjust the flash output

level, etc.

- To control the flash wirelessly, you need a PIXAPRO Pro AC series remote control set (on-camera and on-flash transceiver). Insert its receive end into the Wireless Control Port(9) the flash and insert the transmit end into the camera hot shoe. Settings made on the hotshoe-mounted transceiver and receive ends will be wirelessly communicated to the flash. Then you can press the camera shutter-release button to trigger the flash.

- For full instructions on the use of Pro AC series remote control, see its user manual.

When the flash unit receives wireless signals,  shown on the LCD display.

11. Sync Triggering

The Sync Cord Jack (10) is a $\Phi 3.5$ mm plug. Insert a trigger plug here and the flash will be fired synchronously with the camera shutter.

12. PC Sync Triggering

Insert one end of a PC sync cable into the PC Sync Socket (11) of the flash unit and the other end into the PC Sync Socket on the camera. The flash unit will fire when the camera's shutter-release button is pressed.

Protection Function

Over-Heat Protection

- To avoid overheating and deteriorating the flash head, do not fire more than 40 continuous flashes in fast succession at 1/1 full power. After 40 continuous flashes, allow a rest time of at least 10 minutes.

- If you fire more than 40 continuous flashes and then fire more flashes in short intervals, the inner over-temperature protection function may be activated and make the recycling time about 10 to 15 seconds. If this occurs, allow a rest time of about 10 minutes, and the flash unit will then return to normal.

- When the over-temperature protection is started,  is shown on the LCD display.

Number of flashes that will activate over-temperature protection:

Power Output Level	Number of Flashes (Approx.)
1/1	40
1/2+0.7	60
1/2+0.3	80
1/2	100
1/4(+0.3/+0.7)	200
1/8(+0.3/+0.7)	300
1/16(+0.3/+0.7)	400
1/32(+0.3/+0.7)	400
1/64(+0.3/+0.7)	500
1/128(+0.3/+0.7)	500

Technical Data

Model	RIKO400
Battery	AR-B4500 (Li-ion battery 11.1V/4500mA)
Max Power(Ws)	400Ws
Guide Number(m ISO 100)	36
Full Power Flashes (1/1)	Approx.450 times
M/S1/S2 Mode	1/128~1/1
RPT Mode	1/128~1/4
High-Speed Sync	1/32~1/1
Recycle Time	0.05~2.8s
Color Temperature	5600K±200K
Flash Duration	1/300s-1/10000s
Triggering Method	3.5mm/PC Sync cord, Slave triggering, Test button, Wireless control port
100% LED Brightness(LUX)	440 (0.5 m)
Dimension	22.5*23*7cm
Net Weight (with battery)	Approx.1.4kg

Maintenance

- Shut down the device immediately should abnormal operation be detected.
- Avoid sudden impacts and the lamp should be dedusted regularly.
- It is normal for the flash tube to be warm when in use. Avoid continuous flashes if unnecessary.
- Maintenance of the flash must be performed by our authorized maintenance department which can provide original accessories. The flash-tube is user-replaceable. Replacement tubes can be obtained from the manufacturer.
- This product, except consumables e.g. flash tube, is supported with a one-year warranty.
- Unauthorized service will void the warranty.
- If the product had failures or was wetted, do not use it until it is repaired by professionals.
- Disconnect the power when cleaning the unit or when changing the flashtube.
- Changes made to the specifications or designs may not be reflected in this manual.