

Privia

PX-330

USER'S GUIDE

GUÍA DEL USUARIO

Please keep all information for future reference.
Guarde toda documentación para futuras consultas.

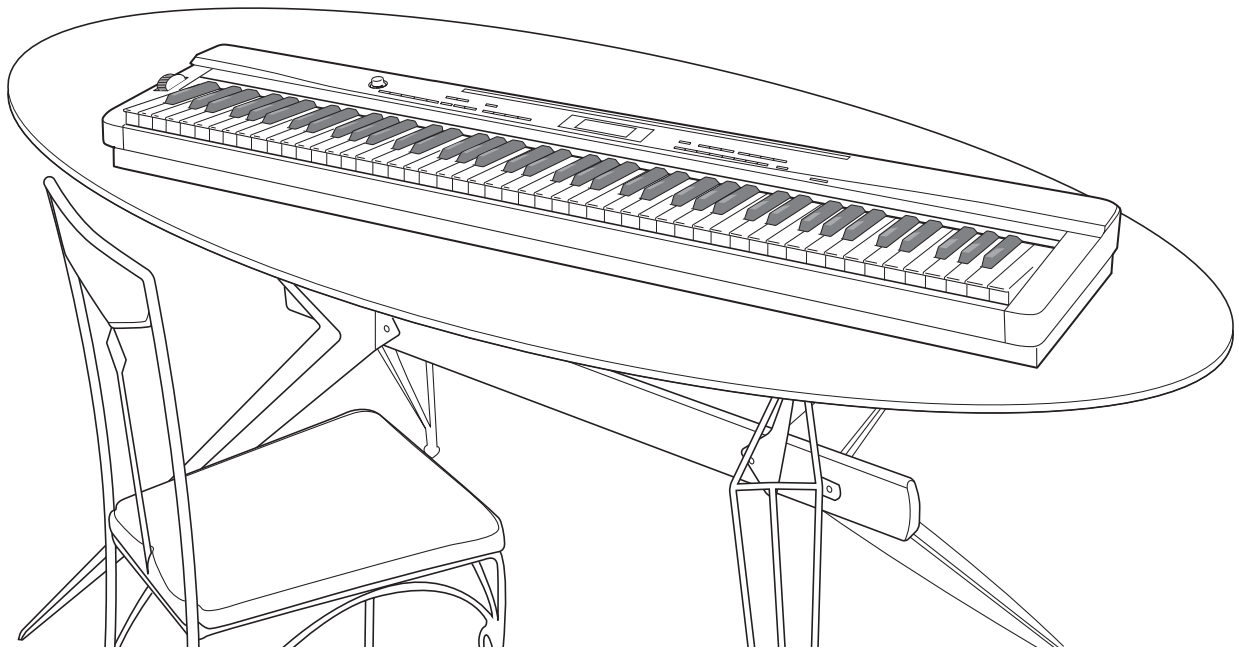
**Safety Precautions**

Before trying to use the piano, be sure to read the separate "Safety Precautions".

Precauciones de seguridad

Antes de intentar usar el piano, asegúrese de leer las "Precauciones de seguridad" separadas.

TO REDUCE THE RISK OF FIRE OR ELECTRIC SHOCK, REFER SERVICING TO QUALIFIED SERVICE PERSONNEL.

IMPORTANT SAFETY INSTRUCTIONS

1. Read these instructions.
 2. Keep these instructions.
 3. Heed all warnings.
 4. Follow all instructions.
 5. Do not use this apparatus near water.
 6. Clean only with dry cloth.
 7. Do not block any ventilation openings. Install in accordance with the manufacturer's instructions.
 8. Do not install near any heat sources such as radiators, heat registers, stoves, or other apparatus (including amplifiers) that produce heat.
 9. Do not defeat the safety purpose of the polarized or grounding-type plug. A polarized plug has two blades with one wider than the other. A grounding type plug has two blades and a third grounding prong. The wide blade or the third prong are provided for your safety. If the provided plug does not fit into your outlet, consult an electrician for replacement of the obsolete outlet.
 10. Protect the power cord from being walked on or pinched particularly at plugs, convenience receptacles, and the point where they exit from the apparatus.
 11. Only use attachments/accessories specified by the manufacturer.
 12. Use only with the cart, stand, tripod, bracket, or table specified by the manufacturer, or sold with the apparatus. When a cart is used, use caution when moving the cart/apparatus combination to avoid injury from tip-over.
- 
13. Unplug this apparatus during lightning storms or when unused for long periods of time.
 14. Refer all servicing to qualified service personnel. Servicing is required when the apparatus has been damaged in any way, such as power-supply cord or plug is damaged, liquid has been spilled or objects have fallen into the apparatus, the apparatus has been exposed to rain or moisture, does not operate normally, or has been dropped.

The apparatus shall not be exposed to dripping or splashing and that no objects filled with liquids, such as vases, shall be placed on the apparatus.

The power indicator being unlit does not mean the apparatus is completely disconnected from the MAINS. When you need to have the apparatus completely disconnected from the MAINS, you must unplug the power cord. For that purpose, locate the apparatus in a way that secures easy access to the power cord.

Declaration of Conformity

Model Number: PX-330
Trade Name: CASIO COMPUTER CO., LTD.
Responsible party: CASIO AMERICA, INC.
Address: 570 MT. PLEASANT AVENUE, DOVER, NEW JERSEY 07801
Telephone number: 973-361-5400

This device complies with Part 15 of the FCC Rules, Operation is subject to the following two conditions:

(1) This device may not cause harmful interference, and (2) this device must accept any interference received, including interference that may cause undesired operation.

NOTICE

This equipment has been tested and found to comply with the limits for a Class B digital device, pursuant to Part 15 of the FCC Rules. These limits are designed to provide reasonable protection against harmful interference in a residential installation. This equipment generates, uses and can radiate radio frequency energy and, if not installed and used in accordance with the instructions, may cause harmful interference to radio communications. However, there is no guarantee that interference will not occur in a particular installation. If this equipment does cause harmful interference to radio or television reception, which can be determined by turning the equipment off and on, the user is encouraged to try to correct the interference by one or more of the following measures:

- Reorient or relocate the receiving antenna.
- Increase the separation between the equipment and receiver.
- Connect the equipment into an outlet on a circuit different from that to which the receiver is connected.
- Consult the dealer or an experienced radio/TV technician for help.

FCC WARNING

Changes or modifications not expressly approved by the party responsible for compliance could void the user's authority to operate the equipment.

Important!

Please note the following important information before using this product.

- Before using the AD-A12150LW Adaptor to power the product, be sure to check the AC Adaptor for any damage first. Carefully check the power cord for breakage, cuts, exposed wire and other serious damage. Never let children use an AC adaptor that is seriously damaged.
- The product is not intended for children under 3 years.
- Use only the CASIO AD-A12150LW adaptor.
- The AC adaptor is not a toy.
- Be sure to disconnect the AC adaptor before cleaning the product.



This mark applies in EU countries only.



Manufacturer:
CASIO COMPUTER CO., LTD.
6-2, Hon-machi 1-chome, Shibuya-ku, Tokyo 151-8543, Japan
Responsible within the European Union:
CASIO EUROPE GmbH
Casio-Platz 1, 22848 Norderstedt, Germany

Contents

General Guide..... E-2

- Installing the Music Stand..... E-3
- Saving Settings and Using Panel Lock..... E-4
- Returning the Digital Piano to Its
Factory Default Settings E-4

Power Outlet..... E-5

- Using an AC Adaptor..... E-5

Connections..... E-6

- Connecting Headphones E-6
- Connecting a Pedal E-6
- Connecting Audio Equipment or an Amplifier E-7
- Bundled and Optional Accessories..... E-8

Using Built-in Tones E-9

- Turning on the Digital Piano and
Playing Something..... E-9
- Selecting a Tone..... E-9
- Layering Two Tones E-10
- Splitting the Keyboard between Two Tones E-11
- Using Octave Shift E-12
- Adjusting the Brilliance of a Tone E-12
- Adding Reverb to the Tone..... E-13
- Adding the Chorus Effect to the Tone..... E-13
- Using the Metronome E-14
- Using the Pitch Bend Wheel E-15
- Playing a Duet E-15

Using Auto

Accompaniment E-17

- Playing an Auto Accompaniment..... E-17
- Using One-Touch Presets E-20
- Using Auto Harmonize..... E-20
- Creating Your Own Original Rhythms..... E-21

Playing Demo Songs..... E-24

- Playing Tone Demo Songs..... E-24
- Listening to Songs Loaded from an
External Source E-25

Music Presets E-27

- Selecting a Music Preset E-27
- Creating an Original User Preset..... E-28

Registering Tone and Rhythm Setups..... E-32

- Saving Registration Data E-33
- Recalling a Registration..... E-33

Recording Your Keyboard Play E-34

- Recording or Playing Back a Single Song E-34
- Recording or Playing Back Multiple Songs E-35
- Recording to a Specific Track (Part) E-35
- Deleting Recorder Data..... E-37
- Re-recording Part of a Recorder Song
(Punch-in Recording) E-37

Other Settings..... E-40

- Configuring Settings..... E-40

Using a Memory Card E-44

- Loading and Removing a Memory Card E-45
- Formatting a Memory Card E-45
- Saving Digital Piano Data to a Memory Card..... E-46
- Loading Data from a Memory Card..... E-47
- Deleting Memory Card Data..... E-47
- Renaming a Memory Card File E-48
- Playing Back a Song from a Memory Card E-48
- Saving Data to Digital Piano Memory
(Internal Area) Instead of a Memory Card..... E-49
- Error Messages..... E-50

Connecting to a Computer E-51

- Minimum Computer System Requirements E-51
- Connecting the Digital Piano to Your Computer E-51
- Using MIDI E-52
- Transferring Data between the Digital Piano
and a Computer E-52

Reference E-56

- Troubleshooting E-56
- Product Specifications..... E-57
- Operating Precautions E-58

Appendix A-1

- Tone List A-1
- Drum Assignment List..... A-3
- Rhythm List A-4
- Music Preset List..... A-6
- Fingering Guide..... A-8
- Chord Example List..... A-9

MIDI Implementation Chart

Company and product names used in this manual may be registered trademarks of others.

General Guide

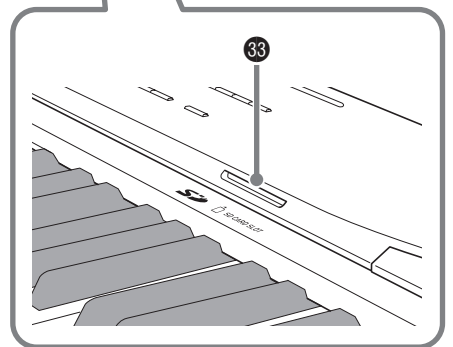
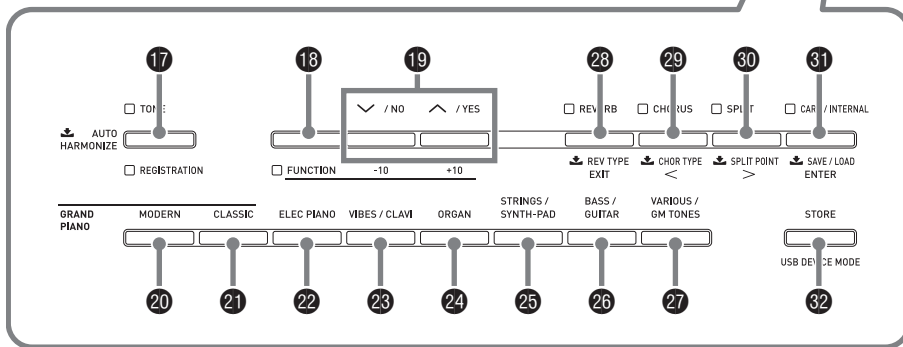
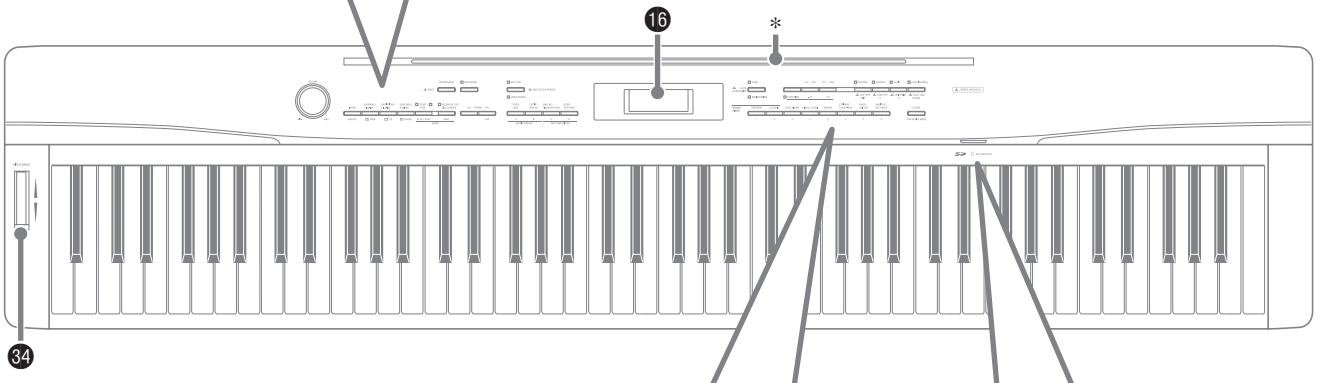
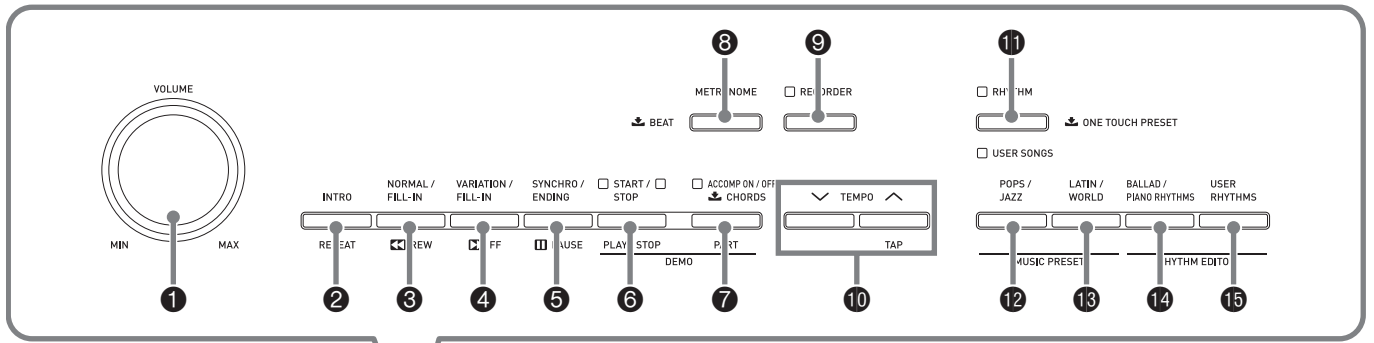

Back

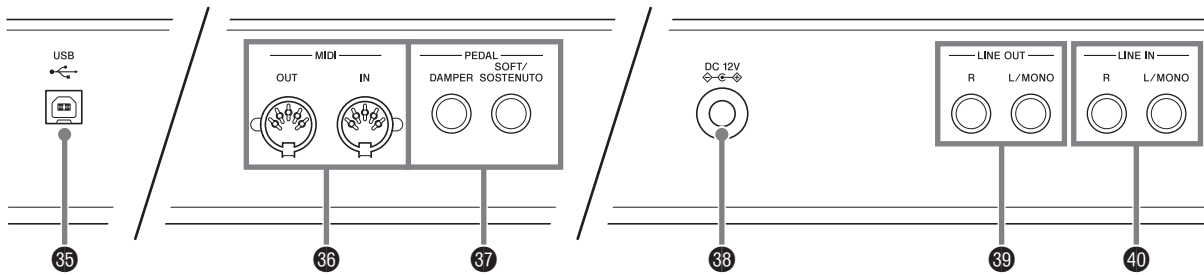

Left Side

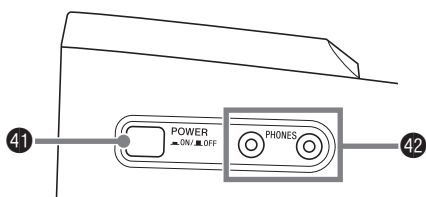

Bottom

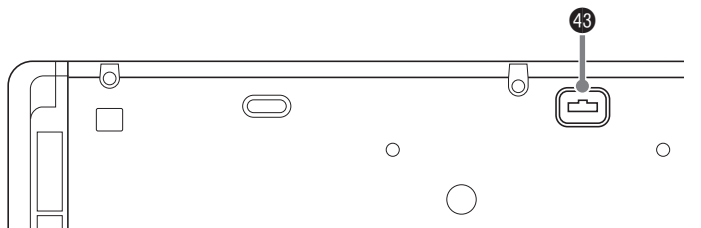

- This manual uses the numbers and names below to refer to buttons and controllers.

- ❶ **VOLUME** controller
- ❷ **INTRO/REPEAT** button
- ❸ **NORMAL/FILL-IN, ◀◀REW** button
- ❹ **VARIATION/FILL-IN, ▶▶FF** button
- ❺ **SYNCHRO/ENDING, PAUSE** button
- ❻ **START/STOP, PLAY/STOP** button
- ❼ **ACCOMP ON/OFF, PART** button
- ❽ **METRONOME** button
- ❾ **RECORDER** button
- ❿ **TEMPO** buttons
- ⓫ **RHYTHM, USER SONGS** button
- ⓬ **POPS/JAZZ, MUSIC PRESET** button
- ⓭ **LATIN/WORLD, MUSIC PRESET** button
- ⓮ **BALLAD/PIANO RHYTHMS, RHYTHM EDITOR** button
- ⓯ **USER RHYTHMS, RHYTHM EDITOR** button
- ⓰ Display
- ⓱ **TONE, REGISTRATION** button
- ⓲ **FUNCTION** button
- ⓳ **∨/NO, ∧/YES** buttons
- ⓴ **GRAND PIANO (MODERN)** button
- ⓵ **GRAND PIANO (CLASSIC)** button
- ⓶ **ELEC PIANO** button
- ⓷ **VIBES/CLAVI** button
- ⓸ **ORGAN** button
- ⓹ **STRINGS/SYNTH-PAD** button
- ⓺ **BASS/GUITAR** button
- ⓻ **VARIOUS/GM TONES** button
- ⓼ **REVERB, REV TYPE, EXIT** button
- ⓽ **CHORUS, CHOR TYPE, <** button
- ⓾ **SPLIT, SPLIT POINT, >** button
- ⓿ **CARD/INTERNAL, SAVE/LOAD, ENTER** button
- ⓿ **STORE, USB DEVICE MODE** button
- ⓿ **SD CARD SLOT**
- ⓿ **PITCH BEND** wheel
- ⓿ **USB** port
- ⓿ **MIDI OUT/IN** terminals
- ⓿ **DAMPER, SOFT/SOSTENUTO PEDAL** jacks
- ⓿ **DC 12V** terminal
- ⓿ **LINE OUT R, L/MONO** jacks
- ⓿ **LINE IN R, L/MONO** jacks
- ⓿ **POWER** button
- ⓿ **PHONES** jacks
- ⓿ Pedal connector

* Installing the Music Stand

Insert the bottom of the music stand into the groove on the top of the Digital Piano's console.

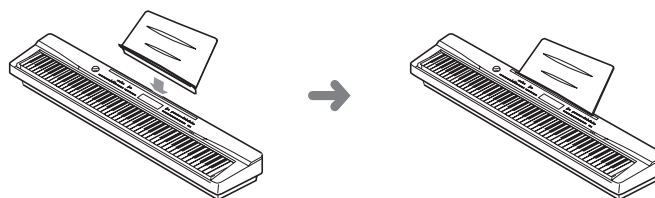

Saving Settings and Using Panel Lock

Your Digital Piano lets you save its current settings, and lock its buttons to protect against operation errors. For details, see “Setting Backup” (page E-43) and “Panel Lock” (page E-43).

Returning the Digital Piano to Its Factory Default Settings

Perform the following procedure when you want to return the Digital Piano’s stored data and settings to their initial factory defaults.

1. Turn off the Digital Piano.
2. While holding down both the **17** (TONE) and **18** (FUNCTION) buttons, press the **41** (POWER) button.

The Digital Piano will turn on and initialize its internal system. You will be able to use the Digital Piano in a short while.

NOTE

- See “Turning on the Digital Piano and Playing Something” (page E-9) for information about turning digital power on and off.

Power Outlet

Your Digital Piano runs on standard household power. Be sure to turn off power whenever you are not using the Digital Piano.

Using an AC Adaptor

Use only the AC adaptor (JEITA Standard, with unified polarity plug) that comes with this Digital Piano. Use of a different type of AC adaptor can cause malfunction of the Digital Piano.

Specified AC Adaptor: AD-A12150LW

- Use the supplied power cord to connect the AC adaptor as shown in the illustration below.

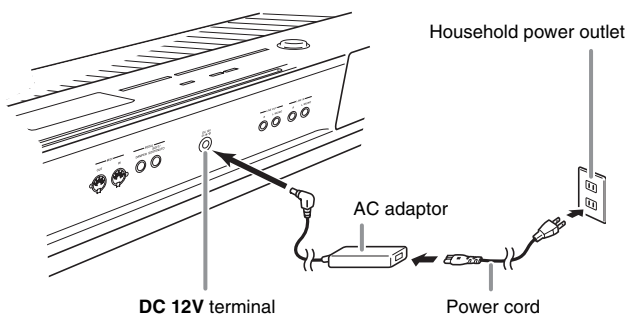

Note the following important precautions to avoid damage to the power cord.

During Use

- Never pull on the cord with excessive force.
- Never repeatedly pull on the cord.
- Never twist the cord at the base of the plug or connector.

During Movement

- Before moving the Digital Piano, be sure to unplug the AC adaptor from the power outlet.

During Storage

- Loop and bundle the power cord, but never wind it around the AC adaptor.



IMPORTANT!

- Never connect the AC adaptor (JEITA Standard, with unified polarity plug) that comes with this Digital Piano to any other device besides this piano. Doing so creates the risk of malfunction.
- Make sure the Digital Piano is turned off before plugging in or unplugging the AC adaptor.
- The AC adaptor will become warm to the touch after very long use. This is normal and does not indicate malfunction.

Connections

Connecting Headphones

IMPORTANT!

- Before connecting headphones, be sure to use the Digital Piano's **VOLUME** controller to turn the volume down to a low level. After connecting, you can adjust the volume to the level you want.
- The Digital Piano automatically adjusts sound output to optimize for headphones (when headphones are connected) or the built-in speakers (when headphones are not connected).

Left Side

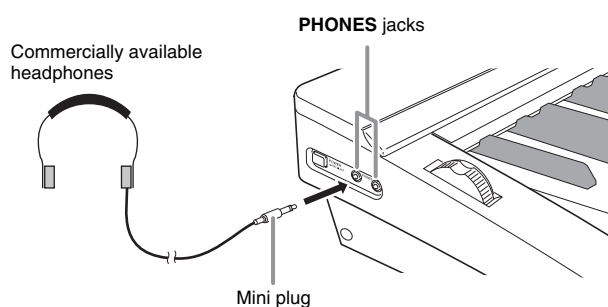

Connect commercially available headphones to the **PHONES** jacks. Connecting headphones to either of the **PHONES** jacks cuts off output to the speakers, which means you can practice even late at night without bothering others. To protect your hearing, make sure that you do not set the volume level too high when using headphones.

Connecting a Pedal

The back of the Digital Piano has two pedal jacks, one for a damper pedal and one for a soft/sostenuto pedal.

To connect to the pedal jack

Depending on the type of operation you want the pedal (SP-3) to perform, connect the pedal's cable either to the Digital Piano's **DAMPER PEDAL** jack or **SOFT/SOSTENUTO PEDAL** jack. If you want to use both operations (jacks) at the same time, you need to purchase another optionally available pedal.

Back

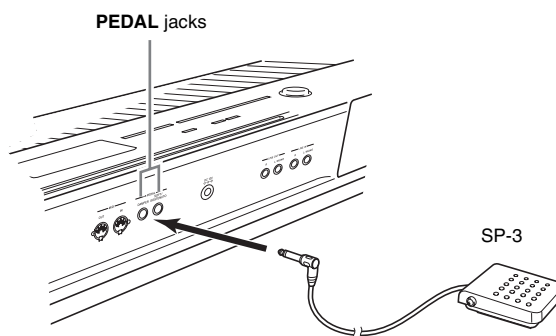

NOTE

- You can connect a pedal to the **SOFT/SOSTENUTO PEDAL** jack and apply either a soft or sostenuto effect to the notes you play. For details, see "Soft/Sostenuto Pedal Jack Setting" (page E-43).

Pedal Functions

● Damper Pedal

Pressing the damper pedal while playing will cause the notes you play to reverberate for a very long time.

- Whenever a piano tone is selected, pressing this pedal will activate the Digital Piano's Acoustic Resonance effect, which causes notes to resonate in the same way they do when the damper pedal on an acoustic piano is pressed. For details, see "Acoustic Resonance" (page E-41).

● Soft Pedal

Pressing this pedal suppresses notes played on the keyboard after the pedal was pressed, and makes them sound softer.

● Sostenuto Pedal

Only the notes that are played while this pedal are depressed are sustained until the pedal is released.

Pedal Connector

You can connect the optionally available 3-Pedal Unit (SP-32) to the pedal connector on the bottom of the Digital Piano. You can then use the pedals for expression that is similar to that available on an acoustic piano.

Bottom

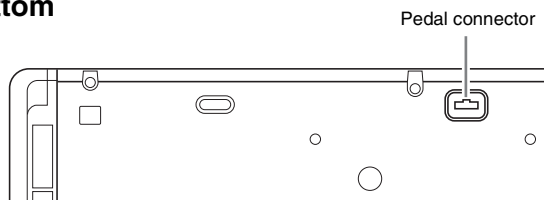

NOTE

- The SP-32 Pedal Unit supports half-pedal operation (pressing the pedal part way). You can adjust the amount of the effect is applied when the damper pedal is pressed part way. For details, see “Half Pedal Effect” (page E-43).
- The optionally available CS-67P special stand is required in order to use the SP-32 Pedal Unit.

Connecting Audio Equipment or an Amplifier

You can connect audio equipment or a music amplifier to the Digital Piano and then play through external speakers for more powerful volume and better sound quality.

IMPORTANT!

- The Digital Piano automatically adjusts sound output to optimize for headphone output (when headphones are connected) or built-in speaker output (when headphones are not connected). This also will cause a change in the output quality from the Digital Piano's **LINE OUT R** and **L/MONO** jacks.
- Whenever connecting a device to the Digital Piano, first use the **VOLUME** controller to set the volume to a low level. After connecting, you can adjust the volume to the level you want.
- Whenever you connect any device to the Digital Piano, be sure to read the user documentation that comes with the device.

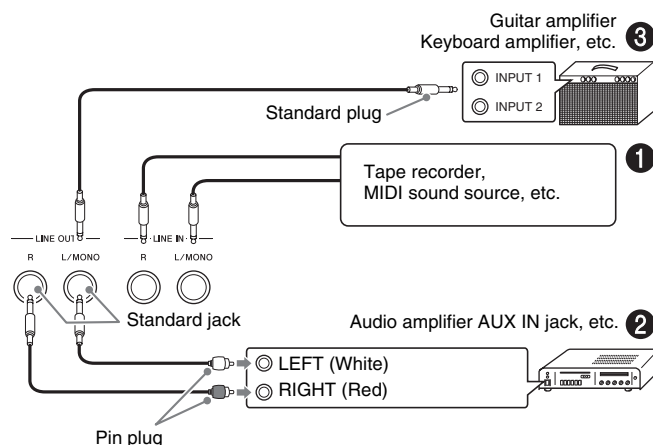

Playing Output from External Equipment through the Piano's Speakers ❶

Use commercially available cables to connect the external audio equipment to the piano's **LINE IN** jacks as shown in Figure ❶.

LINE IN R jack input sounds through the piano's right speaker, while **LINE IN L/MONO** jack input sounds through the left speaker. Connecting to the **LINE IN L/MONO** jack only causes the same output to be produced from both speakers. It is up to you to purchase connecting cables that are compatible with the equipment you are connecting.

Connecting to Audio Equipment ❷

Use commercially available cables to connect the external audio equipment to the piano's **LINE OUT** jacks as shown in Figure ❷. **LINE OUT R** jack output is right channel sound, while **LINE OUT L/MONO** jack output is left channel sound. It is up to you to purchase connecting cables like the ones shown in the illustration for connection of audio equipment.

Normally in this configuration you must set the audio equipment's input selector to the setting that specifies the terminal (such as **AUX IN**) to which the piano is connected. Use the piano's **VOLUME** controller to adjust the volume level.

Connecting to a Musical Instrument Amplifier ❸

Use commercially available cables to connect the amplifier to the piano's **LINE OUT** jacks as shown in Figure ❸. **LINE OUT R** jack output is right channel sound, while **LINE OUT L/MONO** jack output is left channel sound. Connecting to the **LINE OUT L/MONO** jack only outputs a mixture of both channels. It is up to you to purchase connecting cable like the one shown in the illustration for connection of the amplifier. Use the piano's **VOLUME** controller to adjust the volume level.

Bundled and Optional Accessories

Use only accessories that are specified for use with this Digital Piano.

Use of unauthorized accessories creates the risk of fire, electric shock, and personal injury.

NOTE

- You can get information about accessories that are sold separately for this product from the CASIO catalog available from your retailer, and from the CASIO website at the following URL.
<http://world.casio.com/>

Using Built-in Tones

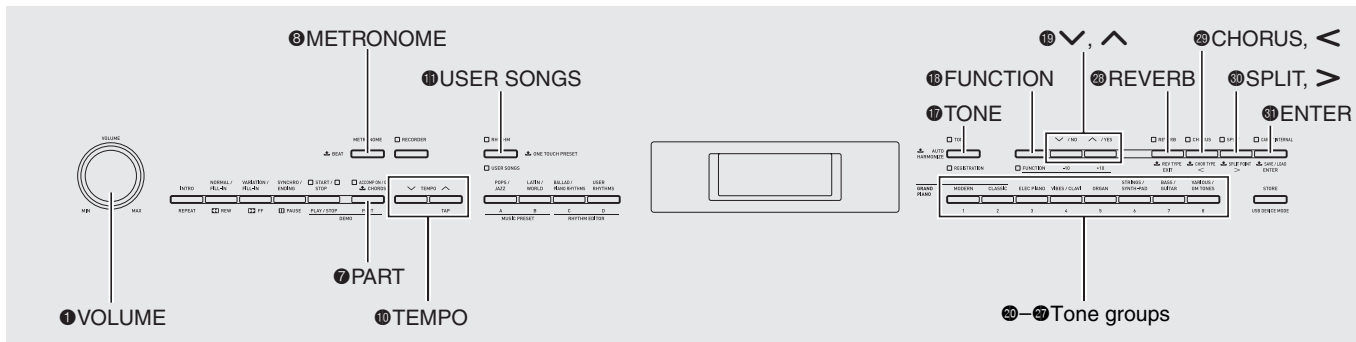

Turning on the Digital Piano and Playing Something

1. Press the **1** (POWER) button.

This turns on power.

- To turn off the Digital Piano, press the **1** button again.

Left Side

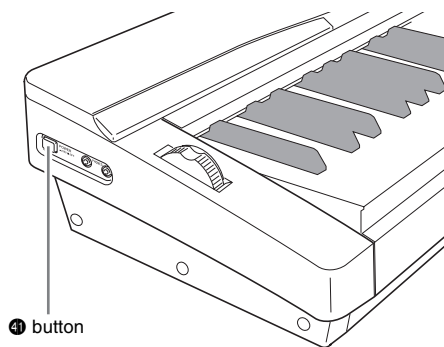

2. After a short while, the display screen should appear as shown below, which indicates that the Digital Piano is ready to be played.



3. Use the **1** (VOLUME) controller to adjust the volume level.
4. Play something on the keyboard.

Selecting a Tone

Your Digital Piano has 250 tones, divided into eight groups.

- For more information, see the “Tone List” (page A-1).
- The Digital Piano has built-in demonstration tunes that highlight the different characteristics of tones. For more information, see “Playing Tone Demo Songs” (page E-24).

1. Press the **17** (TONE) button so its upper lamp is lit.

- Each press of the button toggles between the upper and lower lamps.

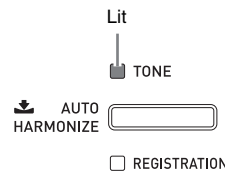

IMPORTANT!

- Continuing on to the next step while the REGISTRATION lamp is lit will perform a registration recall operation (page E-32), which will change the setup of the Digital Piano. Make sure that the TONE lamp is lit before you advance to the next step.
2. Use the “Tone List” (page A-1) to look up the group and the number of the tone you want to select.

3. Use the **20** to **27** (tone groups) buttons to select the group you want.

Example: To select the ORGAN group

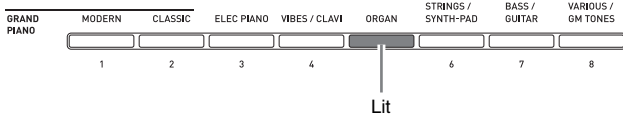

4. Use the **19** (**∨**, **∧**) buttons to select the tone you want.

Example: To select "002 Jazz Organ"

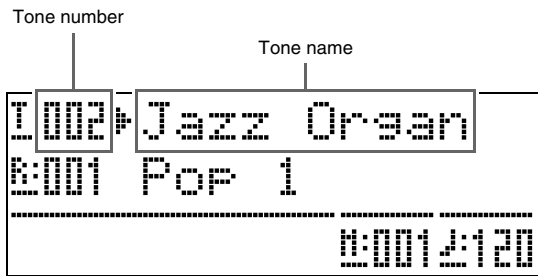

NOTE

- Pressing **∧** and **∨** at the same time will jump to tone 001 of the currently selected group. Holding down either button changes the tone number at high speed.
- See page E-40 for more information about scrolling.

Layering Two Tones

You can layer two different tones so they play at the same time when you press a keyboard key.

- The first tone you select is called the "main tone," while the second tone is called the "layered tone."

1. Select the main tone.

Example: To select MELLOW PIANO in the CLASSIC group, press the **21** (CLASSIC) button and then use the **19** (**∨**, **∧**) buttons to select "002 Mellow Piano".

2. Hold down the button of the group that contains the tone you want to select as the layered tone until "LAYER: ON" appears on the display as shown below for a few moments.

This will layer the tones currently selected in the two groups.

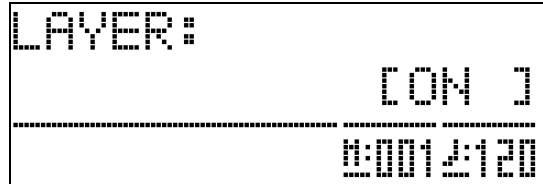

The button you held down in step 2 will light to indicate that it is selected.

Example: When BASS/GUITAR group is selected

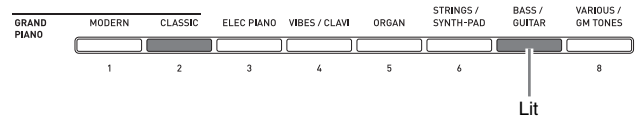

3. Use the **19** (**∨**, **∧**) buttons to select the tone you want in the group you selected in step 2.

Example: When "006 Picked Bass" is selected

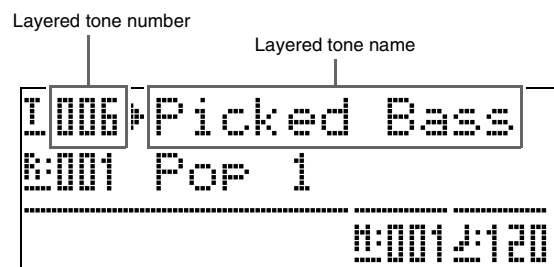

4. To unlayer the tones and return the keyboard to a single tone, press any one of the tone group buttons.

NOTE

- You can adjust the balance between the main tone and layered tone. For details, see "Layered Tone Volume (Layer Balance)" (page E-41).

Splitting the Keyboard between Two Tones

You can split the keyboard so the left side (lower range) plays one tone and the right side (upper range) plays a different tone.

Example: To split the keyboard between the GM SLAP BASS 1 tone on the left (lower range) and the GRAND PIANO tone on the right (upper range).

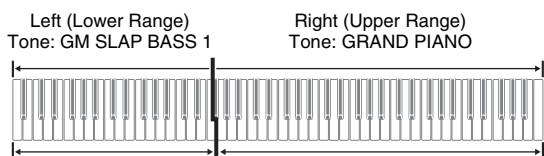

1. Press the **30** (SPLIT) button.

This causes the SPLIT lamp to light, indicating that the keyboard is split between two tones.

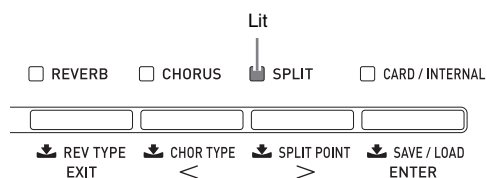

2. Select the tone you want to assign to the left side (lower range) of the keyboard.

Example: To select GM SLAP BASS 1 in the VARIOUS / GM TONES group, press the **27** (VARIOUS / GM TONES) button and then use the **19** (**∇**, **∧**) buttons to select "073 GM SlapBass1".

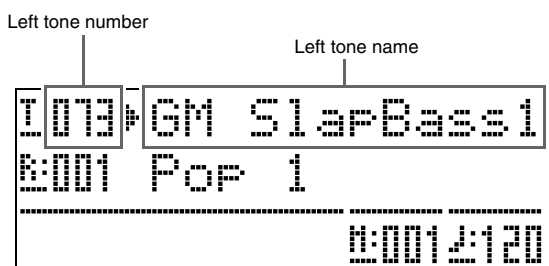
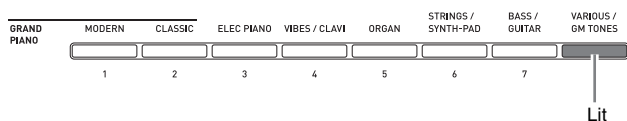

3. To unsplit the keyboard and return it to a single tone, press the **30** (SPLIT) button.

The SPLIT lamp will go out, indicating that the keyboard is no longer split.

NOTE

- If the keyboard is set up with layered tones (page E-10) when you perform the above split operation, the layered tones will play on the right (upper range) side of the keyboard.

Moving the Keyboard Split Point

You can use the procedure below to specify the location on the keyboard where it splits between the left side and the right side. That location is called the "split point".

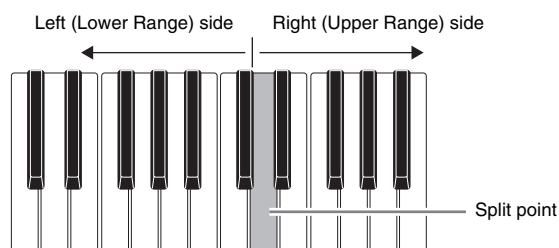

- Hold down the **30** (SPLIT) button until the split point setting screen appears on the display as shown below.

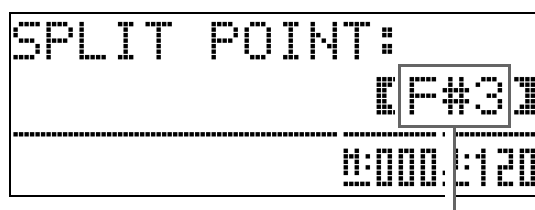

- Press the keyboard key where you want to specify as the leftmost key of the right (upper range) tone.

This specifies the split point.

- Press the **30** (SPLIT) button.

This exits the split point screen.

Using Octave Shift

After you split the keyboard (page E-11), you may find out that the lower range notes on the left are too low or that the upper range notes on the right are too high. You can use octave shift to shift the octaves of the upper range and lower range upwards or downwards in octave units.

1. While holding down the **18** (FUNCTION) button, press the **17** (TONE) button.

This displays the octave shift screen.

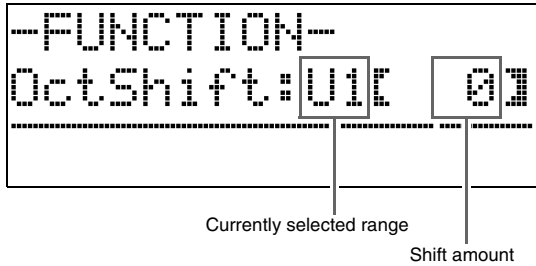

2. Use the **7** (PART) button to select the range whose octave you want to change.

- Each press of **7** (PART) cycles through the ranges below.

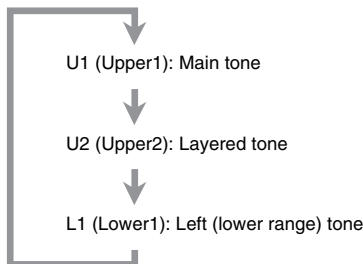

3. Use the **19** (∨, ∧) buttons to shift the octave of the currently selected range.
 - You can shift the octave within the range of -2 to 0 to 2.

4. Press the **18** (FUNCTION) button.

This exits the octave shift screen.

NOTE

- Octave shift also can be performed as described for "Octave Shift" (page E-41).

Adjusting the Brilliance of a Tone

1. Press the **18** (FUNCTION) button.

The FUNCTION lamp will light and the function screen will appear on the display.

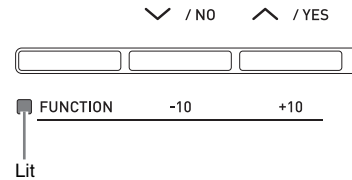

2. Use the **30** (>) and **29** (<) buttons to select the Tmpr/Effect screen.

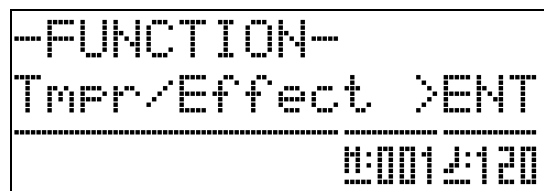

3. Press the **31** (ENTER) button.

This will display a screen for selecting settings in the Tmpr/Effect group.

4. Use the **30** (>) or **29** (<) button to select the brilliance screen shown below.



5. Use the **19** (∨, ∧) buttons to adjust the brilliance of the currently selected tone. You can adjust brilliance in the range of -3 to 0 to 3.

∨: Mellow and softer

∧: Brighter and harder

6. Press the **18** (FUNCTION) button.

This will exit the brilliance screen and cause the FUNCTION lamp to go out.

NOTE

- See "Other Settings" (page E-40) for details about using the **18** (FUNCTION) button.

Adding Reverb to the Tone

1. Press the **28** (**REVERB**) button to toggle reverb on and off.

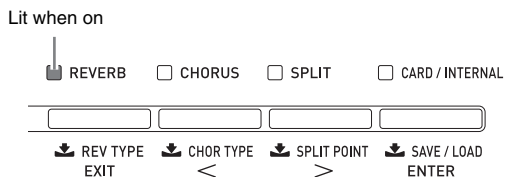

Selecting the Reverb Type

You can select from among the following four types of reverb.

- 1: Room
- 2: Hall
- 3: Large Hall
- 4: Stadium

1. Hold down the **28** (**REVERB**) button until the reverb type selection screen shown below appears on the display.

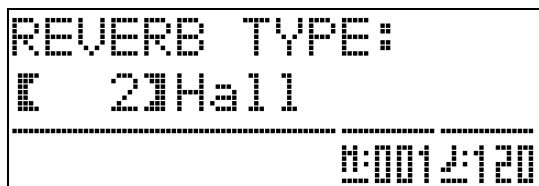

2. Use the **19** (**∨**, **∧**) buttons to select the reverb type you want.
3. Press the **28** (**REVERB**) button to exit the reverb type screen.

Adding the Chorus Effect to the Tone

1. Press the **29** (**CHORUS**) button to toggle chorus (which adds depth to a tone) on and off.

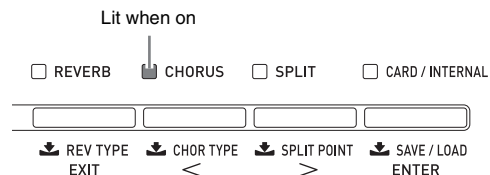

Selecting the Chorus Type

You can select from among the following four chorus types.

- 1: LightChorus
- 2: Chorus
- 3: Deep Chorus
- 4: Flanger

1. Hold down the **29** (**CHORUS**) button until the chorus type selection screen shown below appears on the display.

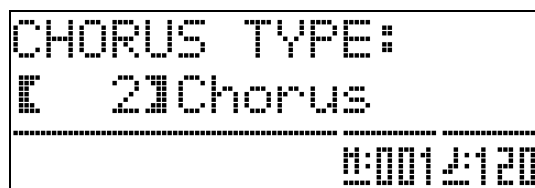

2. Use the **19** (**∨**, **∧**) buttons to select the chorus type you want.
3. Press the **29** (**CHORUS**) button to exit the chorus type screen.

Using the Metronome

1. Press the **3** (METRONOME) button.
This will start the metronome.

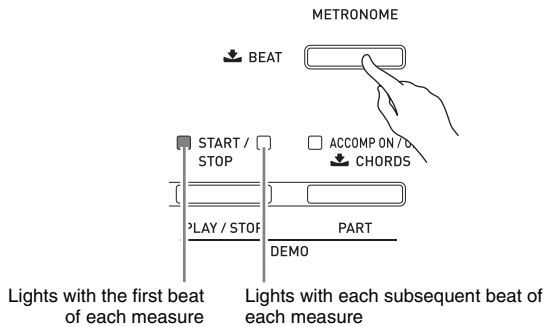

2. Press the **3** (METRONOME) button again to stop the metronome.

Changing the Beats Per Measure

You can specify from two to six beats per measure for the metronome. After you do, a chime will sound at the beginning of each measure. Specifying 0 for this setting will sound a straight beat, without a chime. This setting lets you practice with a steady beat.

1. Hold down the **3** (METRONOME) button until the number of beats per measure screen shown below appears on the display.

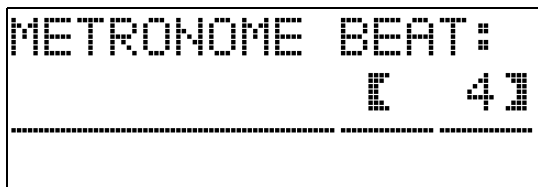

2. Use the **10** (∇ , \blacktriangle) buttons to select the beats per measure value you want.
3. Press the **3** (METRONOME) button to exit the number of beats per measure screen.

Changing the Tempo Setting

There are two different methods you can use to change the tempo setting: by pressing \blacktriangle (faster) and ∇ (slower) buttons or by tapping a beat with a button.

To adjust the tempo using \blacktriangle and ∇ buttons

1. Use the **10** (TEMPO ∇ , \blacktriangle) buttons to adjust the tempo setting.

Each press of a button increases or decreases the beats per minute value by one.

- Holding down either button changes the value at high speed.
- You can specify a tempo value in the range of 20 to 255.



To adjust the tempo by tapping a beat

1. While holding down the **18** (FUNCTION) button, tap the \blacktriangle **10** (TEMPO) button four times in time with the beat you want to specify.

- The tempo setting will change in accordance with the timing of your tapping.
- After you use this method to specify the approximate tempo, you can then use the procedure under "To adjust the tempo using \blacktriangle and ∇ buttons" to adjust the setting to a more exact value.

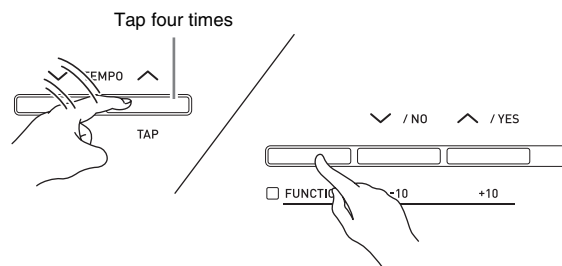

Adjusting the Metronome Volume

You can use the following procedure to adjust the volume level of the metronome, without affecting the volume of Digital Piano output.

1. While holding down the **18** (FUNCTION) button, press the **3** (METRONOME) button. This displays the metronome volume screen.

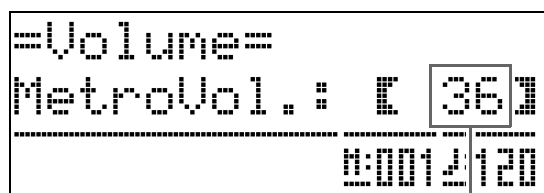

Metronome volume

2. Use the **19** (∇, ▲) buttons to adjust the metronome volume.
3. Press the **18** (FUNCTION) button. This will exit the metronome volume screen and cause the FUNCTION lamp to go out.

NOTE

- You also can use the procedure under “Metronome Volume” (page E-41) to adjust the metronome volume.

Using the Pitch Bend Wheel

You can use the pitch bend wheel to slide the pitch of notes smoothly upwards and downwards. This capability makes it possible to reproduce saxophone and electric guitar choking effects.

Adding a Pitch Bend Effect

1. While playing a note on the keyboard, rotate the pitch bend wheel on the left of the keyboard upwards or downwards.

The amount the note bends depends on how much you rotate the pitch bend wheel.

- Do not have the pitch bend wheel rotated as you turn on the Digital Piano.



NOTE

- You also can configure pitch bend wheel operation by specifying the amount of pitch change at maximum rotation in either direction. See “Pitch Bend Range” (page E-43) for more information.

Playing a Duet

You can use the Duet Mode to split the Digital Piano’s keyboard in the center so two people can play a duet. This makes it possible to configure the keyboard so, for example, the teacher can play on the left and the student can follow along on the right. Or one person can play the left hand part on the left, while another plays the right hand part on the right.

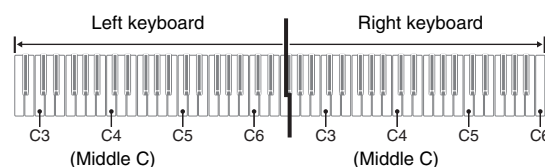

Pedal Operation when Playing a Duet

• Optional SP-32 Pedal Unit

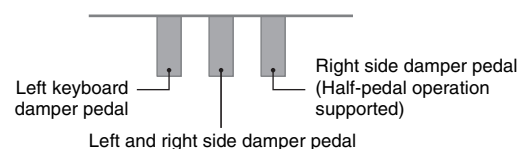

• Optional SP-3 Pedal Unit

To use the SP-3 Pedal Unit as the right keyboard damper pedal, connect it to the **37** (DAMPER PEDAL) terminal.

- Half-pedal operation is not supported in this case.

To use the SP-3 Pedal Unit as the left keyboard (initial default setting) or right keyboard damper pedal (selectable), connect it to the **37** (SOFT/SOSTENUTO PEDAL) terminal.

- For information about how to select left or right keyboard control with the SP-3 Pedal Unit, see “Soft/Sostenuto Pedal Jack Setting” (page E-43).

Configuring the Digital Piano for Duet Play

1. Press the **11** (**USER SONGS**) button so its lower lamp is lit.

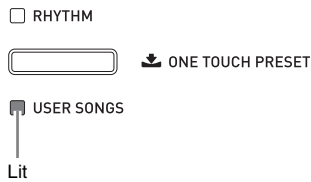

- To practice with songs stored on a memory card, press the **31** (**CARD/INTERNAL**) button so its lamp is lit in place of the **11** (**USER SONGS**) button.

2. While holding down the **18** (**FUNCTION**) button, press the **30** (**SPLIT**) button.

This causes the Duet Mode on/off screen to appear.

- The keyboard keys are disabled while this screen is displayed.



3. Press the **19** (**^**) button to turn on the Duet Mode.

This will cause the **30** (**SPLIT**) button lamp to flash.

4. Press the **18** (**FUNCTION**) button.

This exits the Duet mode on/off screen and configures the Digital Piano's keyboard for duet play.

5. To turn off the Duet Mode, press the **30** (**SPLIT**) button so the SPLIT lamp goes out.

NOTE

- You also can use the procedure under "Duet Mode" (page E-41) to turn the Duet Mode on or off.

Changing the Octave of a Duet Mode Keyboard

You can use the following procedure to change the octave of the left and right Duet Mode keyboards.

1. While holding down the **18** (**FUNCTION**) button, press the **30** (**SPLIT**) button.

This displays the Duet Mode on/off screen shown in step 2 under "Configuring the Digital Piano for Duet Play" (page E-16). If the Duet Mode is currently turned off, press the **19** (**^**) button to turn it on.

2. Of the four C keys in the left keyboard, press the one that you want to have located at middle C.

- This will sound the note assigned to C4 and change the octave of the left keyboard.

Example: To change the configuration so the leftmost C key is middle C as shown below.

Leftmost C key (Pressed key)

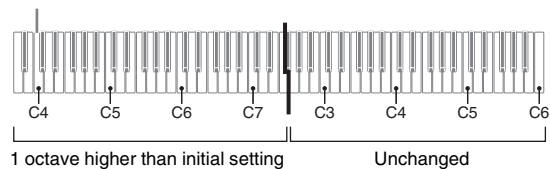

3. You can use the same procedure as step 2 to select one of the C keys in the right keyboard to shift its octave as well.

4. Press the **18** (**FUNCTION**) button.

This exits the Duet Mode on/off screen and causes the **18** (**FUNCTION**) button lamp to go out.

The left and right keyboards will be configured according to your settings.

NOTE

- Turning off the Duet Mode will clear your octave shift settings and return the keyboard to its initial default settings.

Using Auto Accompaniment

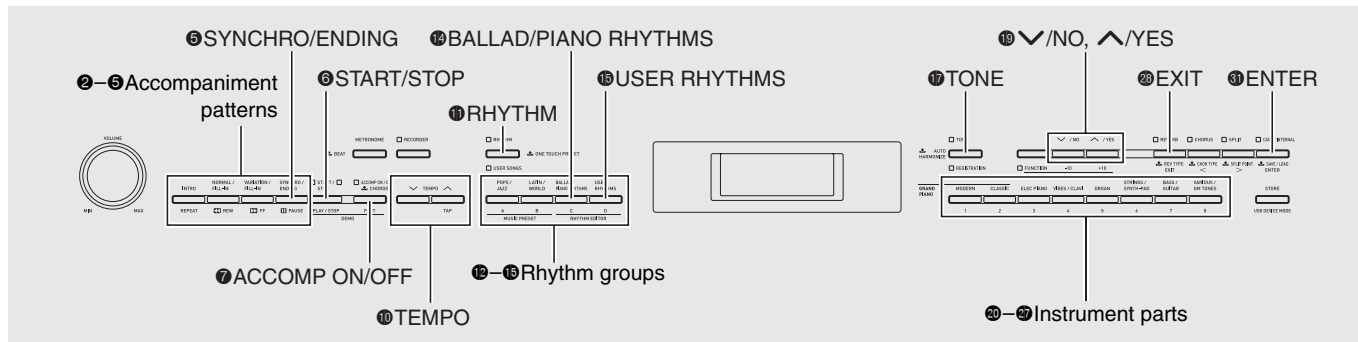

With Auto Accompaniment, simply select the accompaniment rhythm you want and the matching accompaniment (drums, guitar, etc.) will play automatically when you play a chord with your left hand. It's like having your own personal backup group along with you wherever you go.

This Digital Piano has 180 built-in Auto Accompaniment patterns, which are divided into three groups. You can edit built-in rhythms to create your own original rhythms (called "user rhythms"), which you can save in a fourth group. For more information, see the "Rhythm List" (page A-4).

Playing an Auto Accompaniment

1. Press the **11 (RHYTHM)** button so its upper lamp is lit.

This enables Auto Accompaniment.

- Each press of the button toggles between the RHYTHM and USER SONGS lamps.

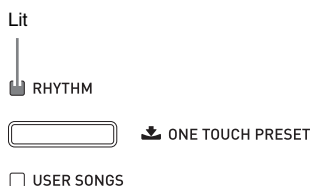

2. Use the "Rhythm List" (page A-4) to look up the group and the number of the rhythm you want to select.

3. Use the **12 to 15 (rhythm groups)** buttons to select the group you want.

Example: When the LATIN / WORLD group is selected

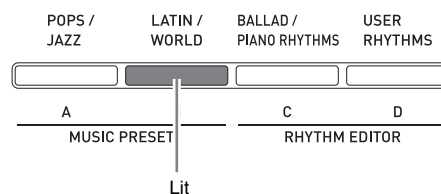

4. Use the **19 (∨, ∧)** buttons to select the rhythm you want.

Example: When "005 Samba 2" is selected

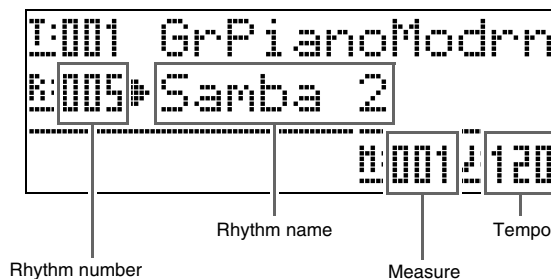

5. Use the **10 (TEMPO ∨, ∧)** buttons to adjust the tempo setting.

- This is the same as metronome tempo adjustment (page E-14).
- To return the rhythm to its standard tempo setting, press the **10 (TEMPO ∨, ∧)** buttons at the same time.

6. Press the **7** (ACCOMP ON/OFF) button so its lamp is lit.

This turns ACCOMP on, so all accompaniment parts sound.

- Turning ACCOMP off so the ACCOMP lamp is unlit causes only the percussion instrument parts to sound.
- Each press of the **7** (ACCOMP ON/OFF) button toggles ACCOMP on and off.

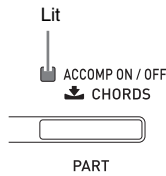

7. Press the **5** (SYNCHRO/ENDING) button.

This puts Auto Accompaniment into “synchro standby”. Playing a chord during synchro standby will cause Auto Accompaniment to start to play automatically.

- Pressing the **2** (INTRO) button while Auto Accompaniment is in synchro standby will enter intro standby. Pressing the **4** (VARIATION) button will enter variation standby. For details about intro and variation patterns, see “Modifying Auto Accompaniment Patterns” (page E-20).

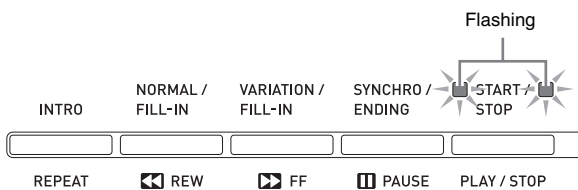

8. Play the chord you want on the chord keyboard (left keyboard keys).

Auto Accompaniment will start playing when you play the chord.

- To start percussion part play without playing a chord, press the **6** (START/STOP) button.

Example: To play a C chord

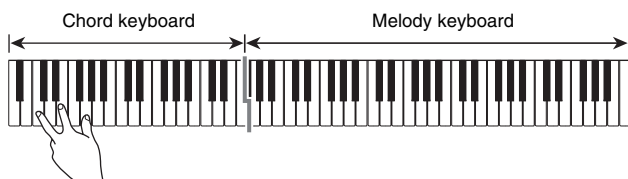

9. Play other chords with left hand as you play the melody with your right hand.

- You can use “CASIO Chord” or other simplified chord fingering modes to play chords. For details, see “Selecting a Chord Fingering Mode” in the following section.
- You can use the **3** (NORMAL) and **4** (VARIATION) buttons to modify accompaniment patterns. For details, see “Modifying Auto Accompaniment Patterns” (page E-20).

10. When you are finished, press the **6** (START/STOP) button again to stop Auto Accompaniment.

- Pressing the **5** (SYNCHRO/ENDING) button instead of the **6** (START/STOP) button will play an ending pattern before stopping Auto Accompaniment play. For details about ending patterns, see “Modifying Auto Accompaniment Patterns” (page E-20).

NOTE

- You can use the following procedure to adjust the volume level of the Auto Accompaniment, without affecting the volume of Digital Piano output. For details, see “Auto Accompaniment Volume” (page E-41).
- You can change the size of the chord keyboard by using the split feature to move the split point (page E-11). The keyboard keys to the left of the split point make up the chord keyboard.

Selecting a Chord Fingering Mode

You can select from among the following five chord fingering modes.

- 1: Fingered 1
- 2: Fingered 2
- 3: Fingered 3
- 4: CASIO Chord
- 5: Full Range

1. Hold down the **7** (**ACCOMP ON/OFF**) button until the chord type selection screen appears on the display.

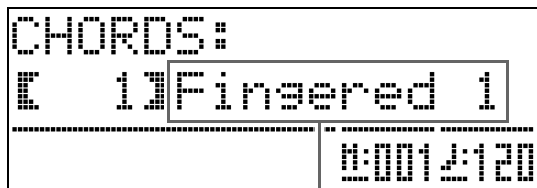

Chord fingering mode

2. Use the **19** (**∨, ∧**) buttons to select the chord fingering mode you want.
3. Press the **7** (**ACCOMP ON/OFF**) button. This exits the chord fingering screen.

■ Fingered 1, 2, 3

With these three chord fingering modes, you play chords on the chord keyboard using their normal chord fingerings. Some chord forms are abbreviated, and can be fingered with one or two keys. For information about the types of chords you can finger and their fingerings, see the “Fingering Guide” (page A-8).



- Fingered 1: Play the component notes of the chord on the keyboard.
- Fingered 2: Unlike Fingered 1, 6th input is not possible with this mode.
- Fingered 3: Unlike Fingered 1, this mode allows input of fraction chords with the lowest keyboard note as the bass note.

■ CASIO CHORD

With “CASIO Chord”, you can use simplified fingerings to play the four types of chords described below.



Chord Type	Example
Major Chords Press one key, whose note corresponds to the chord name. <ul style="list-style-type: none"> To play C Major, press any C key in the chord keyboard. The octave of the note does not matter. 	C (C Major) Note name
Minor Chords Press the chord keyboard key that corresponds to the major chord, while also pressing one other chord keyboard key to the right.	Cm (C minor)
Seventh Chords Press the chord keyboard key that corresponds to the major chord, while also pressing two other chord keyboard keys to the right.	C7 (C seventh)
Minor Seventh Chords Press the chord keyboard key that corresponds to the major chord, while also pressing three other chord keyboard keys to the right.	Cm7 (C minor seventh)

When pressing more than one chord keyboard key, makes no difference whether the additional keys are white or black.

■ FULL RANGE CHORD

With this chord fingering mode, you can use the full range of the keyboard to play chords and the melody. For information about the types of chords you can finger and their fingerings, see the “Fingering Guide” (page A-8).



Modifying Auto Accompaniment Patterns

There are six different Auto Accompaniment patterns, shown below. You can switch between patterns during accompaniment play and even modify patterns. Use buttons ② through ⑤ to select the pattern you want.

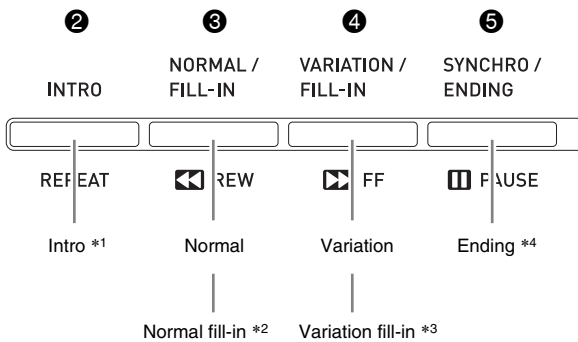

- *1 Press at the beginning of a song. Accompaniment play proceeds with the normal pattern after the intro pattern is complete. Pressing the ④ (VARIATION/FILL-IN) button before pressing this button will proceed with the variation pattern after the intro pattern is complete.
- *2 Press while a normal pattern is playing to insert a fill-in pattern.
- *3 Press while a variation pattern is playing to insert a fill-in variation pattern.
- *4 Press at the end of a song. This will play an ending pattern and then stop Auto Accompaniment.

Using One-Touch Presets

One-Touch Preset gives you one-touch access to tone and tempo settings that go well with the currently selected Auto Accompaniment rhythm pattern.

1. Hold down the ⑪ (RHYTHM) button for at least two seconds.

This will configure tone, tempo, and other settings to match the currently selected rhythm pattern. At this time, Auto Accompaniment play also will go into synchro standby, which means that Auto Accompaniment will start to play automatically when you finger a chord.

2. Play a chord on the keyboard.

This will start Auto Accompaniment play.

NOTE

- One-Touch Presets are not supported for user rhythms (001 through 010 of the USER RHYTHMS group).

Using Auto Harmonize

Auto Harmonize lets you add harmony to melody notes you play with your right hand. You can select any one of 12 Auto Harmonize settings.

1. Press the ⑰ (TONE) button so its lamp is lit.

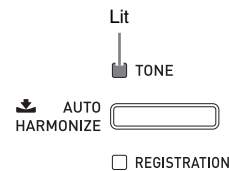

2. Hold down the ⑰ (TONE) button until the auto harmonize screen appears on the display.

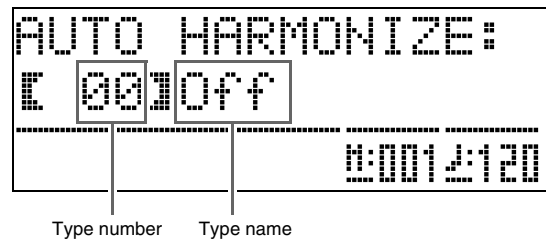

3. Use the **19** (∨, ∧) buttons to select the Auto Harmonize type you want.

Type Number	Type Name	Description
00	Off	Turns off Auto Harmonize.
01	Duet 1	Adds close (separated by two to four degrees) one-note harmony below the melody note.
02	Duet 2	Adds open (separated by more than 4 to 6 degrees) 1-note harmony below the melody note.
03	Country	Adds country style harmony.
04	Octave	Adds the note from the next lower octave.
05	5th	Adds the fifth degree note.
06	3-Way Open	Adds 2-note open harmony, for a total of three notes.
07	3-Way Close	Adds 2-note close harmony, for a total of three notes.
08	Strings	Adds harmony that is optimal for strings.
09	4-Way Open	Adds 3-note open harmony, for a total of four notes.
10	4-Way Close	Adds 3-note close harmony, for a total of four notes.
11	Block	Adds block chord notes.
12	Big Band	Adds big band style harmony.

4. Press the **17** (TONE) button.

This will exit the auto harmonize screen.

5. While playing chords, play the melody on the keyboard.

Harmony will be added to your melody notes based on the chords you play.

Creating Your Own Original Rhythms

You can use rhythm editing to modify a built-in Auto Accompaniment rhythm to create an original “user rhythm” of your own. You can select a part (drum, bass, etc.) of a normal, intro, or other pattern (page E-20) and turn it on or off, adjust its volume level, and perform other operations.

1. Select the number of the Auto Accompaniment rhythm you want to edit.
2. At the same time, press the **14** (BALLAD/PIANO RHYTHMS) and **15** (USER RHYTHMS) buttons.

This displays the rhythm editor screen.

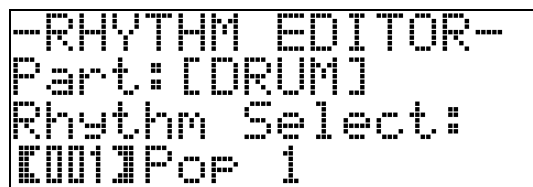

3. Use the accompaniment pattern buttons (**2** through **5**) to select the pattern (normal, intro, ending, etc.) you want to edit.

The button you press will light, indicating that the pattern is being edited.

- Each press of **3** (NORMAL/FILL-IN) toggles between NORMAL and FILL-IN, and each press of **4** (VARIATION/FILL-IN) toggles between VARIATION and FILL-IN. The applicable button flashes while the fill-in pattern is selected.

Example: When intro is selected

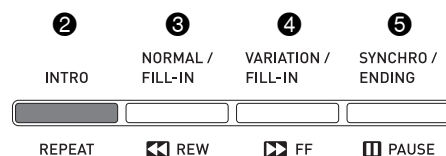

4. Use the instrument part buttons (20 through 27) to select the part (drums, bass etc.) you want to edit.

The name of the part you select will appear on the display. Rhythm patterns are made up of the eight parts shown below.

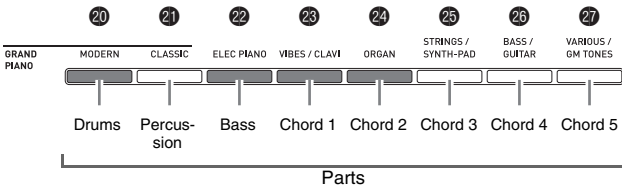

- Button illumination does not change when you press the instrument part buttons (20 through 27). Button illumination indicates whether there is accompaniment data corresponding to each part.

Example: When bass is selected

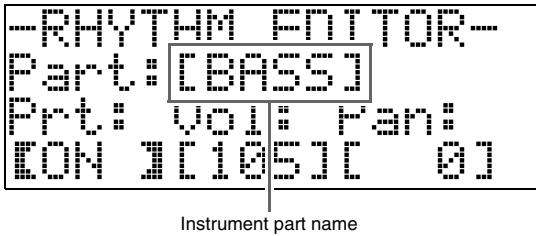

5. Edit the selected part as desired.

The table below describes the parameters you can edit.

- Use the 29 (<) and 30 (>) buttons to select a parameter, and the 19 (v, ^) buttons to change its setting. You also can use shortcut buttons (see table below) to select parameters.
- Pressing the 19 (v, ^) buttons at the same time will return the currently selected parameter to its initial default setting.
- Pressing the 6 (START/STOP) button during an edit operation will sound the accompaniment pattern with the edits you have made up to that point. Pressing the 7 (ACCOMP ON/OFF) button will sound only the instrument part you are editing.

Procedure continues on page E-23.

Parameter	Description	Setting	Shortcut Button
Rhythm Select: Rhythm	Replaces the part (drum, bass, etc.) accompaniment data with that of the specified rhythm number. *1	001 to 190: Rhythm number *2 *3	12
Tone Select: Tone	Switches the part tone (instrument) to that of the specified tone number.	001 to 250: Tone Numbers *2 *4	13
Prt: Part on/off	Toggles each part on or off.	OFF: Mutes the part. ON: Sounds the part.	14
Vol: Volume level	Controls the volume level of each part.	000 to 127	
Pan: Panning (position)	Controls whether the sound of the part can be heard from the left side or right side.	-64 to 0 to 63 *5	15
Reverb: Reverb	Controls the level of the reverb effect (page E-13) applied to the part notes.	000 to 127	
Chorus: Chorus	Controls the level of the chorus effect (page E-13) applied to the part notes.	000 to 127	

- *1 Replacing part accompaniment data clears all edits to the currently selected accompaniment data made up to that point.
- *2 Sequential numbers starting from 001, which is the first rhythm of the first group (POPS/JAZZ). See the "Tone List" (page A-1) and "Rhythm List" (page A-4) for information on the numbering system.
- *3 In the case of the intro and ending, specifying a rhythm for one part (drum, bass, etc.) will cause the same rhythm to be specified automatically for all of the other parts of the pattern.
- *4 Only drum set sounds (tone numbers 237 through 250) can be selected for drum parts and percussion parts. Drum set sounds cannot be selected for the bass and the chord 1 through chord 5 parts.
- *5 A smaller value shifts leftward, while a larger value shifts rightward. A value of zero specifies center.

6. Repeat steps 3 through 5 to edit all of the accompaniment patterns and parts you want.
7. After editing is complete, adjust the tempo of the rhythm as desired.
 - The tempo you set here becomes the initial default tempo of the rhythm.
8. Press the **28** (EXIT) button.

This causes a confirmation message to appear asking if you want to save your edits.

```

-RHYTHM EDITOR-
SAVE?

No/Yes
  
```

9. Press the **19** (YES) button.

This displays a screen for specifying the user rhythm number and rhythm name.

- If you want to exit the editing operation without saving, press the **19** (NO) button instead of the **19** (YES) button.

```

-RHYTHM EDITOR-
Area & Name
[001]PianoRockBld
>ENT
  
```

Destination user rhythm number

Rhythm name

10. Decide on the user rhythm number where you want to save the rhythm and a rhythm name.
 - Use the **29** (<) and **30** (>) buttons to move the cursor to the user rhythm number and rhythm name character you want to change. Use the **19** (∨, ^) buttons to select the number or character you want.
 - The rhythm name characters you can select are shown below. To input a space, press both of the **19** (∨ and ^) buttons at the same time.

!	"	#	\$	%	&	'	()	
*	+	,	-	.	/	0	1	2	3
4	5	6	7	8	9	:	;	<	=
>	?	@	A	B	C	D	E	F	G
H	I	J	K	L	M	N	O	P	Q
R	S	T	U	V	W	X	Y	Z	[
¥]	^	_	`	a	b	c	d	e
f	g	h	i	j	k	l	m	n	o
p	q	r	s	t	u	v	w	x	y
z	{		}						

11. Press the **31** (ENTER) button.

This saves the data.

- If the rhythm number where you are saving the data already has data saved to it, a message (Replace?) will appear on the display to confirm whether you want to replace the existing data with the new data.



IMPORTANT!

- Saving user rhythm data to a user rhythm number that already has data will cause the existing data to be replaced by the new data.



NOTE

- If the size of the accompaniment pattern or instrument part data is too large to be edited, a memory full message (Memory Full) will appear on the display. If that happens, select a different accompaniment pattern or instrument part for editing.

Playing Demo Songs

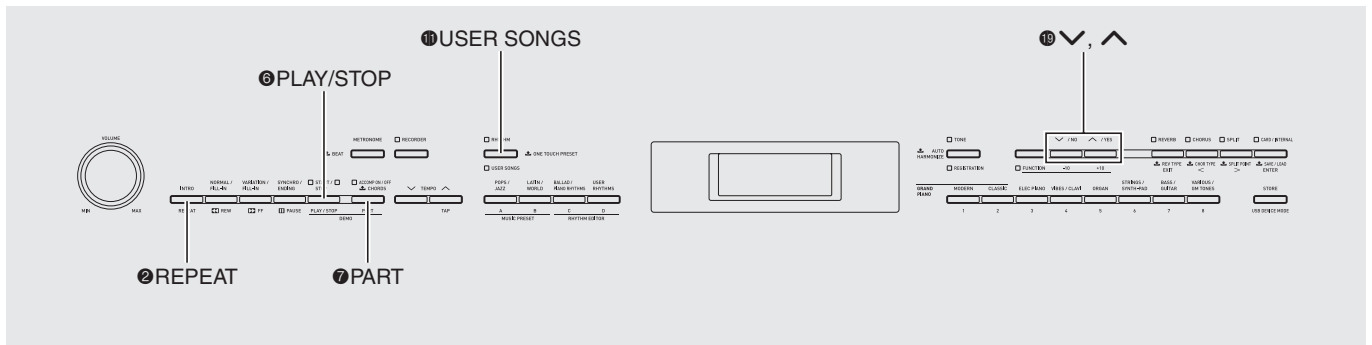

Playing Tone Demo Songs

Your Digital Piano comes with eight built-in demo tunes, which demonstrate the characteristics of each of the eight tone groups.

No.	Tone Group Name	Tune Name
01	GRAND PIANO MODERN	Original
02	GRAND PIANO CLASSIC	Arabesque 1
03	ELEC PIANO	Original
04	VIBES/CLAVI	Original
05	ORGAN	Original
06	STRINGS/ SYNTH-PAD	Nessun Dorma [Turandot]
07	BASS/GUITAR	Original
08	VARIOUS/GM TONES	Original

1. While holding down the **7 (PART)** button, press the **6 (PLAY/STOP)** button. This will start sequential playback of the demo songs, starting from song 1.

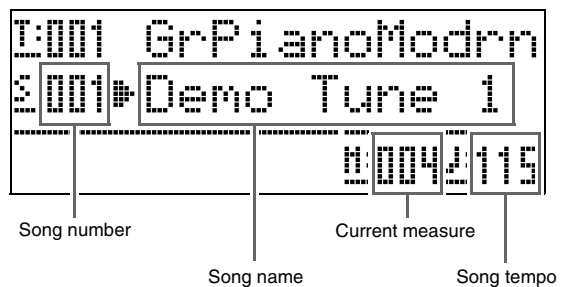
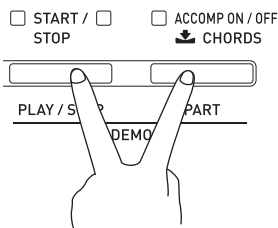

- Pressing a tone group button (**20** through **27**) while demo song playback is in progress will switch to the demo song of that group's tone. Also, you can scroll through songs manually with the **19 (V, ^)** buttons.

2. Press the **6 (PLAY/STOP)** button.

This stops demo song playback. Playback of the demo songs will continue in an endless loop until you press the **6 (PLAY/STOP)** button to stop it.

NOTE

- Only the operations described above can be performed while demo song playback is in progress.

Listening to Songs Loaded from an External Source

You can import song data from an SD memory card or computer as a user song, and use it for Auto Accompaniment or for practice.

1. Load the song data you want to listen to one of the Digital Piano's user songs.

- See "Loading Data from a Memory Card" (page E-47) and "Connecting to a Computer" (page E-51) for details about how to load data.
- You also could play back data directly from a memory card without loading it into Digital Piano memory. For details, see "Playing Back a Song from a Memory Card" (page E-48).

2. Press the **11** (USER SONGS) button so its lamp is lit.

- Each press of the button toggles between the upper and lower lamps.

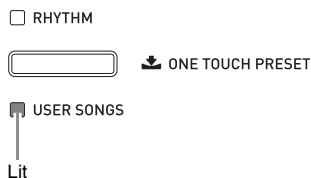

3. Use the **19** (∨, ∧) buttons to select the user song you want.

Example: When user song 003 is selected

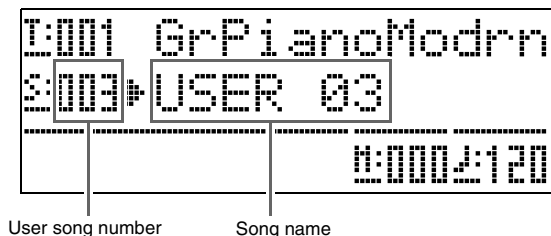

4. Press the **6** (PLAY/STOP) button.

This starts playback of the song.

- Press the **4** (FF) button to perform a fast forward operation or the **3** (REW) button for rewind. Pressing and releasing either button moves one measure, while holding down a button scrolls at high speed.
- Pressing the **5** (PAUSE) button pauses playback. Press again to resume song playback.

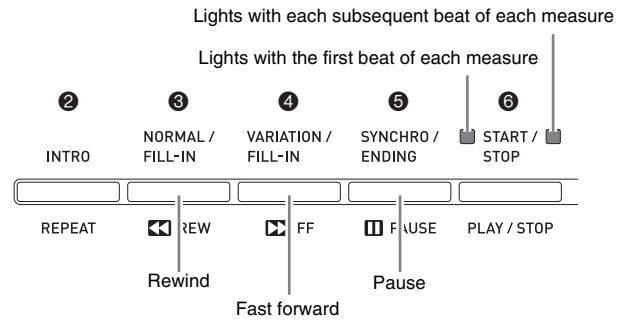

5. Press the **6** (PLAY/STOP) button again.

This stops song playback.

- Song playback also will stop automatically when the end of the song is reached. To configure the Digital Piano to loop song playback without stopping, turn on "Song Repeat" (page E-42).

Changing the Song Tempo

You can change the song tempo using the same procedure that you use to adjust the metronome tempo. For more information, see "Changing the Tempo Setting" (page E-14).

Playing on the Keyboard Using the Same Tone as the Song

1. Hold down the **11** (USER SONGS) button for at least two seconds.

This will assign the same tone as the right hand part of the current song to the keyboard.

NOTE

- You can use the procedure under "Practicing Either Hand's Part (Part Off)" (page E-26) to turn off the left hand part and play along on the keyboard using the left hand part tone.

Adjusting the Song Volume

You can use the following procedure to adjust the volume level of the song's Auto Accompaniment, without affecting the volume of keyboard tone output. For details, see "Song Volume" (page E-41).

Practicing Either Hand's Part (Part Off)

You can turn off the right hand part*¹ or left hand part*² of a song and play that part on the Digital Piano while the song plays back.

*1 Song data Channel 4 (fixed)

*2 Song data Channel 3 (fixed)

1. Press the **7 (PART)** button.
This causes "L-[ON] R-[ON]" to appear on the display.
2. Use the **19 (∨, ^)** buttons to turn off the part you want.
Press (∨) to toggle the left hand part or (^) to toggle the right hand part on and off.
3. Press the **7 (PART)** button again.
This exits the part on/off screen.
4. Hold down the **11 (USER SONGS)** button for at least two seconds.
This will assign the same tone as the hand that is turned off to the keyboard.
5. Press the **6 (PLAY/STOP)** button to start song playback.
The part you turned off does not sound, so you can play it on the keyboard.

Sounding a Count at the Beginning of a Song

You can configure the Digital Piano to sound a count before playback of a song starts, which helps to get the timing right when you are playing along on the keyboard. For details, see "Pre-count" (page E-42).

Repeating Playback of a Specific Section (Repeat)

You can configure the Digital Piano to repeat the section of a song you want to practice. You could, for example, specify repeat play from measure 5 to measure 8.

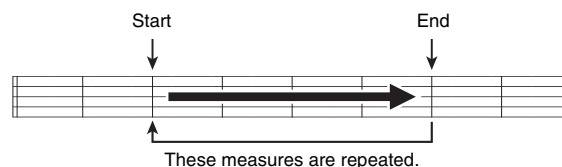

1. Press the **6 (PLAY/STOP)** button.
This starts playback of the song.
2. When playback reaches the first measure of the section you want to repeat, press the **2 (REPEAT)** button.
This makes the measure the "start measure".
The **2 (REPEAT)** button lamp flashes at this time.
3. When playback reaches the last measure of the section you want to repeat, press the **2 (REPEAT)** button again.
This makes the measure the "end measure".
Repeat playback of the specified section starts as soon as you select the end measure.
The **2 (REPEAT)** button lamp is lit (not flashing) at this time.
4. Pressing **2 (REPEAT)** again returns to normal play.
This will cause the **2 (REPEAT)** button lamp to go out.

Music Presets

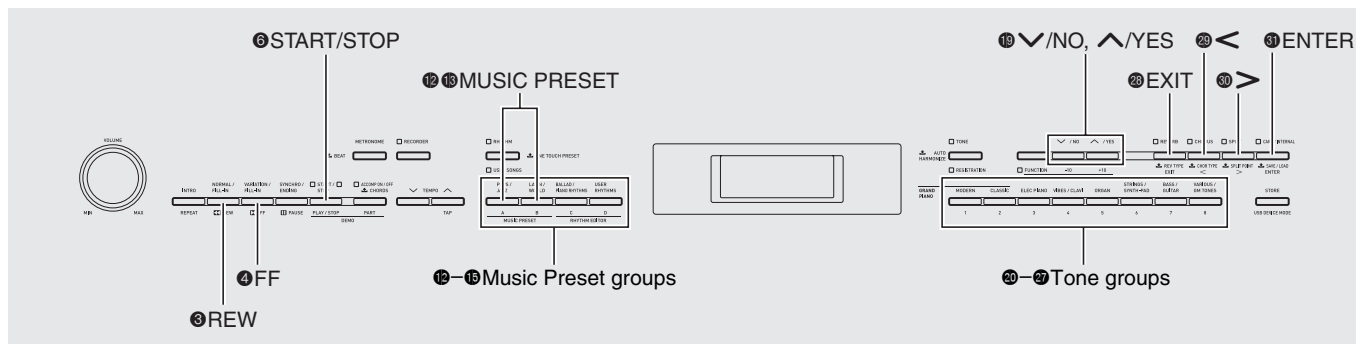

Music Presets provide you with one-touch tone, rhythm, chord, and other settings that are optimized for specific musical genres and songs. In addition to built-in presets, you can create your own original Music Presets (user presets).

There are a total of 300 built-in Music Presets, which are divided into three groups (A, B, C). A fourth group (D) is provided for user presets.

- For more information, see the “Music Preset List” (page A-6).

Selecting a Music Preset

1. Press **12** and **13** (**MUSIC PRESET**) at the same time.

This causes the **7** (**ACCOMP ON/OFF**) lamp to flash and the Music Preset screen to appear.



Music Preset number Music Preset name

2. Use buttons **12** to **15** (Music Preset group buttons) to select a group, and then use the **19** (**∨, ∧**) buttons to select the Music Preset you want.

This will configure the Digital Piano with settings (tone, rhythm, etc.) of the selected Music Preset.

The following are the settings that are included in a Music Preset.

- Tones (main, layer, lower split) (page E-9)
- Layer balance (page E-10)
- Octave shift (page E-12)
- Reverb (page E-13)
- Chorus (page E-13)
- Rhythm (page E-21)
- Tempo (page E-20)
- Auto Harmonize (page E-20)

3. Press the **6** (**START/STOP**) button to start Auto Accompaniment with the chord progression of the Music Preset. Play the melody on the keyboard.

- The preset chord progression repeats until you stop it by pressing the **6** (**START/STOP**) button again.
- Pressing the **7** (**ACCOMP ON/OFF**) button so the ACCOMP ON/OFF lamp is lit (not flashing) or unlit will turn off the chord progression of the Music Preset and play the normal Auto Accompaniment pattern.
- Each press of the **7** (**ACCOMP ON/OFF**) button cycles in the sequence shown below.

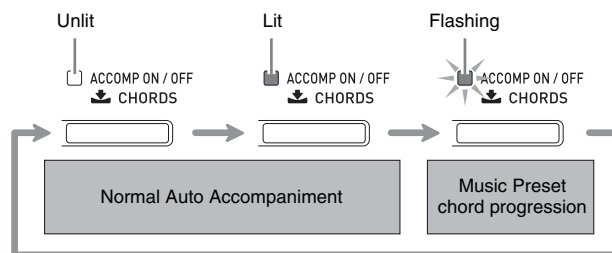

- You can use the following steps to change the rhythm after selecting a Music Preset.

- (1) Hold down the **11** (**RHYTHM**) button until the displayed Music Preset number and name change to the rhythm number and name.
- (2) Use the **19** (**∨, ∧**) buttons to select the rhythm you want.
- (3) Hold down the **11** (**RHYTHM**) button again until the rhythm number and name change back to the Music Preset number and name.

- To change the tone, use the **20** through **27** (tone group) buttons to select the tone group and then use the **19** (**∨, ∧**) buttons to select a tone number.

4. To exit a Music Preset, press **12** and **13** (**MUSIC PRESET**) at the same time.

Creating an Original User Preset

A Music Preset editor is provided to allow you to create your own original Music Presets (user presets). Up to 50 user presets can be stored in Music Preset Group D.

1. Select the Music Preset you want to edit in order to create your user preset.
2. Change the tone number, rhythm number, and other settings of the Music Preset as you want.
 - The settings you configure here will be saved as a user Music Preset. See step 2 under "Selecting a Music Preset" (page E-27) for the settings you can configure and save for a user Music Preset.
3. Press the **14 (BALLAD/PIANO RHYTHMS)** and **15 (USER RHYTHMS)** buttons at the same time.

This displays a screen for selecting the type of editing operation you want to perform.

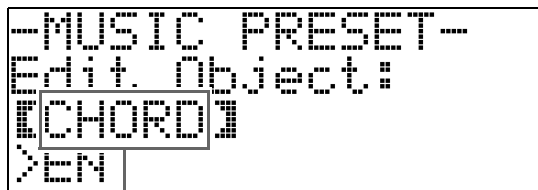

Editing operation type

4. Edit the Music Preset parameters.

4-1. To edit the chord progression

Press the **19 (V)** down button to display "CHORD" and then press the **31 (ENTER)** button to advance to the chord progression editing screen.

Next, perform the editing operation described under "To edit the chord progression" (page E-29). After you finish the editing operation, press the **23 (EXIT)** button to return to the screen for selecting the type of editing operation, above.

4-2. To edit Auto Accompaniment parameters

Press the **19 (^)** up button to display "Parameter" and then press the **31 (ENTER)** button to advance to the Auto Accompaniment parameter editing screen.

Next, perform the editing operation described under "To edit Auto Accompaniment parameters" (page E-31). After you finish the editing operation, press the **23 (EXIT)** button to return to the screen for selecting the type of editing operation, above.

5. After editing everything you want, press the **23 (EXIT)** button.

- This will display a message asking if you want to save the user preset.

6. Press the **19 (YES)** button.

This displays a screen for selecting the Music Preset number and name for storing the edited data.

- If you do not want to save the edited data, press the **19 (NO)** button in place of the **19 (YES)** button.



Music Preset name

Music Preset number for data storage

7. Use the **19 (V, ^)** buttons to select the Music Preset number where you want to store the edited data.

8. Enter a name for the preset.

Use the 29 (<) and 30 (>) buttons to move the cursor to the character you want to change and then use the 19 (V, ^) buttons to change the character. The following shows a table of available characters.

- To input a space, press both of the 19 (V and ^) buttons at the same time.

!	"	#	\$	%	&	'	()	
*	+	,	-	.	/	0	1	2	3
4	5	6	7	8	9	:	;	<	=
>	?	@	A	B	C	D	E	F	G
H	I	J	K	L	M	N	O	P	Q
R	S	T	U	V	W	X	Y	Z	[
¥]	^	_	`	a	b	c	d	e
f	g	h	i	j	k	l	m	n	o
p	q	r	s	t	u	v	w	x	y
z	{		}						

9. Press the 31 (ENTER) button.

This saves the data.

- If the preset number where you are saving the data already has data saved to it, a message (Replace?) will appear on the display to confirm whether you want to replace the existing data with the new data.

To edit the chord progression

- On the editing operation selection screen (page E-28), select "CHORD" and then press the 31 (ENTER) button to display the chord progression editing screen shown below.

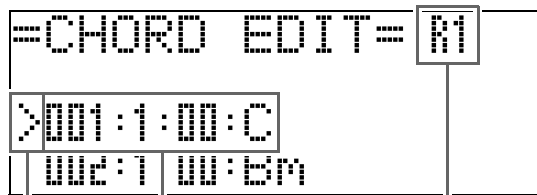

(2) Cursor (1) Step (timing and chord) (3) Resolution

(1) Step (timing and chord)

The timing of a chord progression is expressed as a series of three values separated by colons (such as 001:1:00) indicating measure*1 (001), beat (1), and tick (00).*2 This series of three values is referred to collectively as a "step".

The screen shot above shows the first two steps (001, 002) of the Music Preset. Use the 3 (REW) and 4 (FF) buttons to scroll and view other steps.

*1 Up to 999 measures

*2 There are 12 ticks per beat, as shown below.

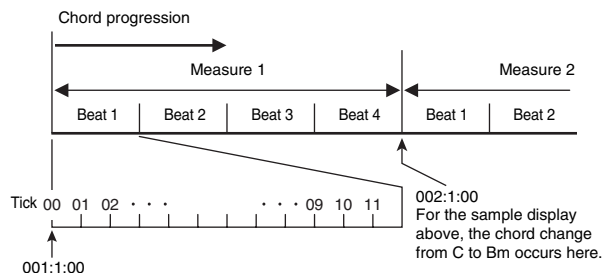

(2) Cursor

Specifies the step that is currently selected for editing.

(3) Resolution

Resolution is a unit used when editing step timing. The initial resolution is R1 (one measure), but you also can select R4 (1 beat = 4 quarter notes) when you want to specify chords for each beat. Use the instrument part buttons (20 through 27) to select one of the eight resolutions shown below.

20	21	22	23	24	25	26	27	
GRAND PIANO	MODERN	CLASSIC	ELEC PIANO	VIBES / CLAVI	ORGAN	STRINGS / SYNTH-PAD	BASS / GUITAR	VARIOUS / GM TONES
1	2	3	4	5	6	7	8	
R1	R2	R4	R8	R8T	R16	R16T	R32T	
(1 measure)	(2 beats)	(1 beat)	(1/2 beat)	(1/3 beat)	(1/4 beat)	(1/6 beat)	(1/8 beat)	

2. Use the **3** (REW) and **4** (FF) buttons to move the cursor (2) on the chord progression editing screen to the step you want to select.

3. Change the content of the selected step as desired.

3-1. Select a chord fingering mode and use the chord keyboard (page E-19) to input chords.

Fingering a chord causes the cursor (2) to move to the next step automatically.

- If you want to advance to the next step without changing the current chord, press the **5** (PAUSE) button.
- If (3) Resolution is shorter than the time up to the next step, a new step (without chord) that is equal to the time of the resolution will be inserted temporarily into the Music Preset. Fingering a chord for the new step will cause the step to be registered as part of the Music Preset, and the cursor will advance to the next step.* You can use this operation to insert a new step between the current and following step.

* Using the **3** (REW) and **4** (FF) buttons to move the cursor without inputting a chord will delete the temporarily inserted step.

3-2. Use the **19 (∨, ∧) buttons to change the step timing (measure:beat:tick).**

Each press of either button changing the timing in accordance with the resolution.

- The range of values you can specify for the step timing is limited by the steps before and after the current step.
- The timing of the first step (001:1:00) is fixed and cannot be changed. Also, the final step is always one measure, regardless of the resolution.

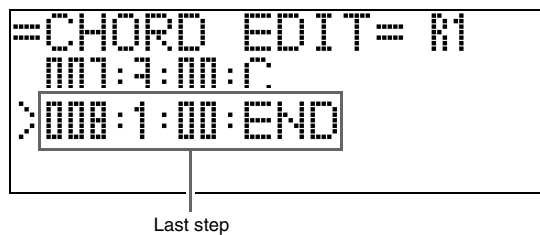

3-3. To delete a step, press both of the **19 (∨ and ∧) buttons at the same time.**

- You cannot delete the first step or the last step.

4. Repeat the above steps to edit all of the steps you want.

- You can playback the Music Preset you are currently editing by pressing the **6** (START/STOP) button.
- The table below describes other Music Preset editing operations you can perform. Press the **18** (FUNCTION) button, use the **29** (<) and **30** (>) buttons to select the editing operation you want, perform the required operation, and then press the **31** (ENTER) button to apply the edit and return to the chord progression editing screen.
- To exit the editing operation and discard all of your edits, press the **28** (EXIT) button.

	Editing Operation (Display)	Description	Operation
1	Initialize (Initialize)	Initializes all steps. Initialization is useful when you want to create a totally new chord progression from scratch.	-
2	Change Key (Change Key)	Changes the pitch (key) of the chords in all of the steps in semitone units.	Use the 19 (∨, ∧) buttons to select the amount of change you want (-5 to 6 semitones).
3	Append Music Preset (Append Chords)	Copies all of the steps of another Music Preset to the end of the current Music Preset.	Use the 19 (∨, ∧) buttons to select the number* of the Music Preset you want to add.
4	Delete Measures (DELETE Measure)	Deletes a specified number of measures from the current cursor step forward.	Use the 19 (∨, ∧) buttons to select the measures.
5	Insert Measure (INSERT 1Measure)	Inserts a blank measure at the currently selected step.	-

* The Music Presets in groups B, C, and D are numbered sequentially, following the numbers in group A, which start with 001. For details about sequential numbers, see the "Music Preset List" on page A-6.

5. After all editing operations are complete, press the **28** (EXIT) button to return to the editing operation selection screen (page E-28).

NOTE

- A single preset can contain up to approximately 2,000 chords. If your edits cause the chord limit to be exceeded, the message "Memory Full" will appear on the display and further editing will become impossible.

■ To edit Auto Accompaniment parameters

1. On the editing operation selection screen (page E-28), select “Parameter” and then press the **31** (ENTER) button to display the Auto Accompaniment parameter editing screen shown below.

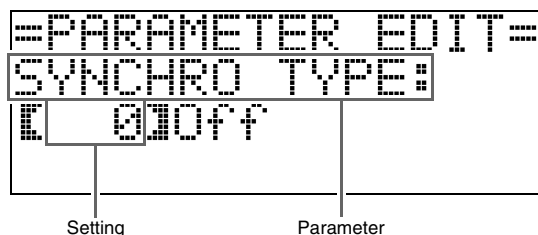

2. Use the **29** (<) and **30** (>) buttons to select a parameter, and the **19** (∨, ^) buttons to change its setting.

	Parameter	Description	Setting
1	SYNCHRO TYPE: Synchro type	Selects the synchro standby status and type when the Music Preset is selected.	0 Off: Off (no standby) 1 Normal: From standby to normal pattern 2 Variation: From standby to variation pattern 3 Intro: From standby to intro pattern
2	DRUM ON/OFF: Drum on/off	Toggles the drum part (page E-22) on or off.	OFF: Mutes the part. ON: Sounds the part.
3	PERC ON/OFF: Percussion on/off	Toggles the percussion part (page E-22) on or off.	OFF: Mutes the part. ON: Sounds the part.
4	BASS ON/OFF: Bass on/off	Toggles the bass part (page E-22) on or off.	OFF: Mutes the part. ON: Sounds the part.
5 - 9	CHORD1 - 5 ON/OFF: Chord 1 - 5 on/off	Toggles the Chord 1 through 5 parts (page E-22) on or off.	OFF: Mutes the parts. ON: Sounds the parts.
10	INTRO CHORD: Intro chord	Selects from among major (× 12 keys) and minor (× 12 keys) for the intro chords.	C - B: Major (C to B) Cm - Bm: Minor (Cm to Bm)
11	ENDING CHORD: Ending chord	Selects from among major (× 12 keys) and minor (× 12 keys) for the ending chords.	C - B: Major (C to B) Cm - Bm: Minor (Cm to Bm)
12	AUTO FILL-IN: Auto fill in on/off	Specifies whether or not a fill-in should be inserted into the final measure of a chord progression.	OFF: Fill-in not inserted ON: Fill in inserted
13	TIMING SET: Chord progression variation	<ul style="list-style-type: none"> This parameter lets you add different variations to the timing of the chord progression being edited. You can use it to match the chord progression to the beat of a specific rhythm. A chord (step) that is outside of the rhythm's beat is cut off. 	1 Normal: Edited chord progression proceeds as-is. 2 Half: Halves chord timing within a measure. 3 Double: Doubles chord timing within a measure. 4 3/4: Multiplies chord timing within a measure by 3/4. Select this setting to match to a 6/8 time rhythm. 5 6/4: Multiplies chord timing within a measure by 3/2. Select this setting to match to a 6/4 time rhythm.

3. After all editing operations are complete, press the **28** (EXIT) button to return to the editing operation selection screen (page E-28).

Registering Tone and Rhythm Setups

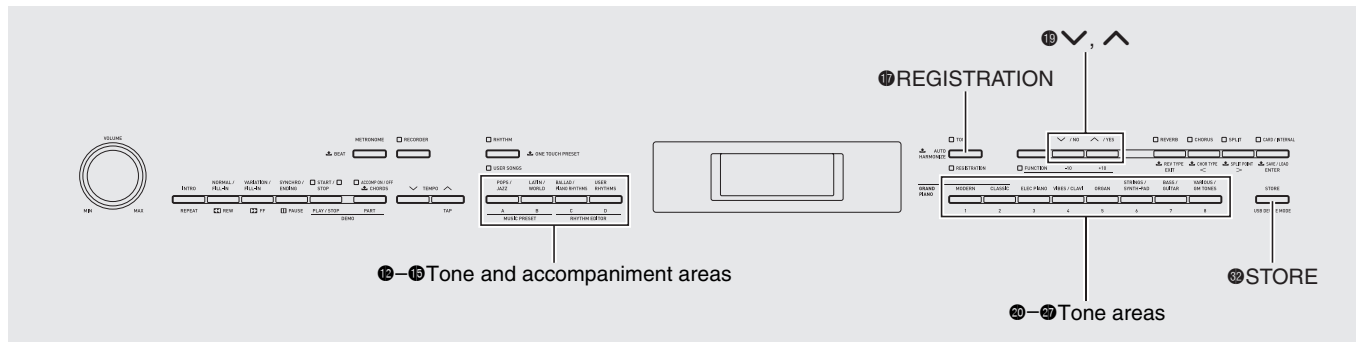

Registrations let you save Digital Piano setups (tone, rhythm, tempo, etc.) and for quick and easy recall when you need them.

Registrations are stored using eight banks of 12 areas each as shown in the illustration below, for a total of 96 setups. Areas A through D on the left (tone and accompaniment area) is for storing tones and Auto Accompaniment settings, while areas 1 through 8 (tone areas) are for storing tone settings only.

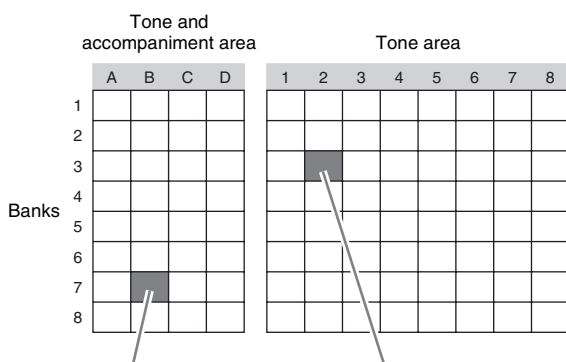

Bank 7, Area B data

Tone Settings
 Keyboard Tone:
 003 Harpsichord
 Brightness: 2
 Reverb: 1 Room
 Chorus: Off
 .
Auto Accompaniment Settings
 Rhythm: 005 Pop Rock
 Tempo: 180
 Accompaniment Volume:
 098
 .
 .

Bank 3, Area 2 data

Tone Settings
 Keyboard Tone:
 002 Electric Piano2
 Brightness: -1
 Reverb: 4 Stadium
 Chorus: 1 LightChorus
 .
 .

Registration Data Types

● Tone Settings

- Tone numbers (main, layer, lower split)
- Layer on/off
- Layer balance
- Split on/off
- Split point
- Octave shift
- Brightness
- Reverb
- Chorus
- Transpose
- Touch response
- Soft/sostenuto pedal setting
- Damper pedal adjustment
- Pitch bend range

● Auto Accompaniment Settings (Areas A through D only)

- Rhythm number
- Accomp on/off
- Chord fingering mode
- Synchro standby
- Tempo
- Auto Accompaniment volume
- Auto harmonize

Saving Registration Data

1. Configure the Digital Piano with the tone, rhythm, and other settings you want to save.
2. While holding down the **32 (STORE)** button, use the **19 (V, ^)** buttons to select the bank where you want to save the registration.

Example: Bank 4



3. Next, hold down the **32 (STORE)** button again as you use the rhythm group buttons (**12** through **15**) or instrument part buttons (**20** through **27**) to select an area.

The data will be saved to the bank and area you specify.

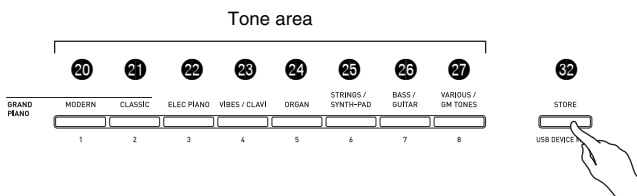
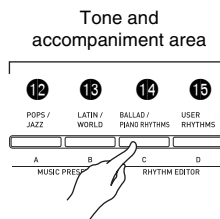

Example: Bank 4, Area C



Recalling a Registration

1. Press the **17 (REGISTRATION)** button so its lower lamp is lit. This enters the registration recall mode.

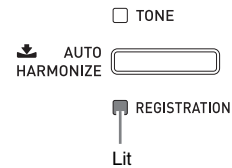

2. Use the **19 (V, ^)** buttons to select the bank where the registration you want to recall is located.
3. Use the rhythm group buttons (**12** through **15**) or instrument part buttons (**20** through **27**) to specify the area.

This will configure the Digital Piano with the registration data located at the bank and area you specified.

Example: When recalling the registration data in Bank 4, Area C



Recording Your Keyboard Play

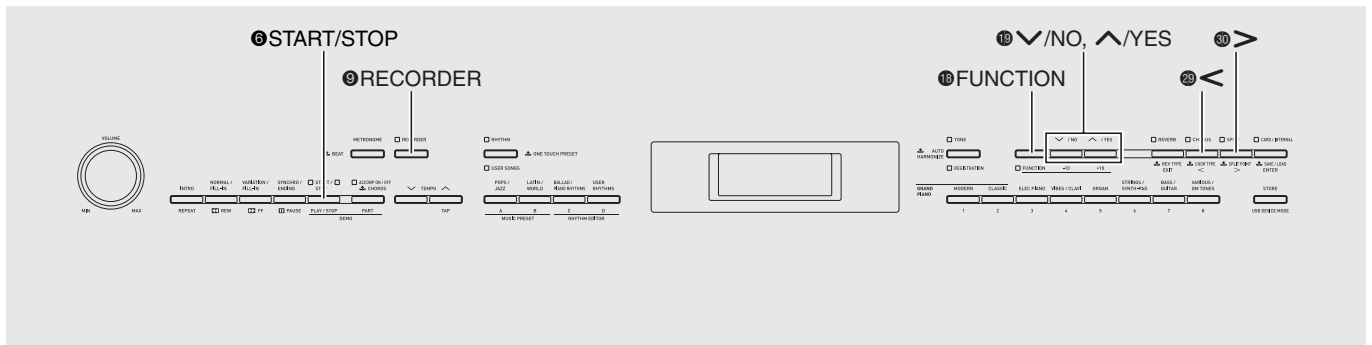

You can record your music as you play and store up to five songs in Digital Piano memory for later playback. You can divide a song into parts (by instrument, by left hand and right hand, etc.) and record each part separately. You can even use “punch-in recording” to edit specific parts of existing recordings.

Recording or Playing Back a Single Song

The following are the steps for recording or playing back a single recorder memory song.

1. Press the **9 (RECORDER)** button twice so its lamp is flashing.

This turns on the recorder and enters record mode.

- Each press of the **9 (RECORDER)** button cycles through modes as shown below.

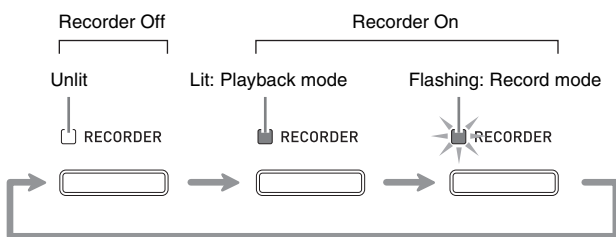

2. Configure the tone, rhythm, and other settings you want to use.

- The settings you configure here will be included as part of the recorded song data.
- For details about what is included in the recorded song data, see “System Track” (page E-35).

3. Play something on the keyboard.

Recording starts as soon as you play something.

- If Auto Accompaniment is playing, it will be included in the recorded data.

4. When you are finished, press the **6 (START/STOP)** button.

This will cause the **9 (RECORDER)** lamp to flash and then light, indicating the playback mode.

- If you are using Auto Accompaniment, you also can end the recording session by pressing the **5 (ENDING)** button.

Lit: Playback mode



5. To play back what you have recorded, press **6 (START/STOP)** again.

- Each press of **6** starts and stops playback.

6. To turn off the recorder, press the **9 (RECORDER)** button so its lamp goes out.

Unlit: Recorder off



NOTE

- Recorder memory capacity is approximately 10,000 notes per song. When remaining capacity is 100 notes or less, the **9 (RECORDER)** button lamp will flash at high speed. Recording will stop automatically when memory becomes full.
- Repeat, fast reverse, fast forward, pause, and tempo adjustment during playback are the same as when playing back user songs. See “Listening to Songs Loaded from an External Source” (page E-25) for more information.
- You can listen to the song data currently stored in recorder memory at any time by pressing the **9 (RECORDER)** button to enter the playback mode and then pressing **6 (START/STOP)**.

IMPORTANT!

- A new recording replaces (deletes) previously recorded contents.
- If power to the Digital Piano is cut off while recording is in progress, everything you recorded up to that point will be deleted. Take care so power is not turned off accidentally during recording operations.

Recording or Playing Back Multiple Songs

You can record up to five songs (numbered 1 through 5) in memory. After that, you can select a specific song for playback.

1. Use the **9** (RECORDER) button to cycle through the recorder modes until the playback mode is selected.

Lit: Playback mode



2. While holding down the **18** (FUNCTION) button, press the **9** (RECORDER) button. This displays the song selection screen.

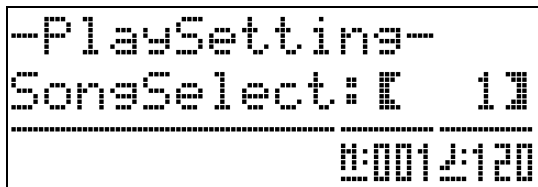

3. Use the **19** (V, ^) buttons to select the song number you want.
4. Press the **23** (EXIT) button to exit the song selection screen.
5. To record to the currently selected song, press the **9** (RECORDER) button. To play back the currently selected song, press the **6** (START/STOP) button.
6. If you are recording, continue from step 2 under "Recording or Playing Back a Single Song" (page E-34).

Recording to a Specific Track (Part)

You can record specific instruments, the left hand and right hand, or other parts of a song individually, and then combine them into a final song.

■ What is a track?

A "track" is a separate recorded part of a song. The recorder of this Digital Piano supports a total of 17 tracks, which are divided between two types described below.

● System Track

In addition to notes you play on the keyboard and other performance operation data, the system track also includes a wide range of setup information for the song, including layer on/off, split on/off, tempo, Auto Accompaniment settings, reverb on/off, etc. When you record a single-track song to recorder memory, as shown under "Recording or Playing Back a Single Song" (page E-34) and "Recording or Playing Back Multiple Songs" (page E-35), everything is recorded to the system track.

● Tracks 01 through 16

These tracks can be used to record notes, as well as pitch bend wheel and pedal operations, and the keyboard tone setting. These tracks can be combined with the system track and each other to create the final song.

■ Supported Track Data

The following describes the data that can be recorded to each type of track.

System Track, Tracks 01 through 16

Keyboard notes, keyboard tone setting (main), pedal and pitch bend wheel operation

System Track only

Layer, split, octave shift, reverb, chorus, keyboard temperament, tempo, Auto Accompaniment play, auto harmonize, one-touch preset, Music Preset,*¹ registration*^{1*2}

*1 Recall only

*2 The Auto Accompaniment volume level and transpose setting of the recalled data is not included in the recording.

1. Record the first part to the system track.

- Use the procedure under “Recording or Playing Back a Single Song” (page E-34) or “Recording or Playing Back Multiple Songs” (page E-35) to record to the system track.

2. Use the **9** (RECORDER) button to cycle through the recorder modes until the RECORDER lamp is flashing (record mode).

Flashing: Record mode



3. While holding down the **18** (FUNCTION) button, press the **9** (RECORDER) button.

This displays the track selection screen.

Use the **19** (▼, ▲) button to select the track you want to record next (T01 through T16).

After selecting a track, press the **28** (EXIT) button to exit the track selection screen.

Track Name	Display
System Track	Sys
Tracks 01 through 16	T01 through T16

```

--RecSetting--
TrSelect:  [Sys]
-----
           0:0012:120
  
```

4. Select the tone of the part you want to record to the track.

5. Press the **6** (START/STOP) button.

This will start playback of what you recorded to the system track and start recording to the currently selected track. Play what you want to record to the current track along with the playback from the system track.

6. To stop recording, press the **6** (START/STOP) button again.

This enters the playback mode. Press the **6** (START/STOP) button again to play back the track you just recorded. Each press of **6** (START/STOP) starts and stops playback.

- You can use the following procedure to turn specific tracks on (play enabled) and off (play disabled). This allows you to listen only to the track(s) you want when recording a new track.

- (1) While holding down the **18** (FUNCTION) button, press the **9** (RECORDER) button. This displays the song selection screen.
- (2) Press the **30** (>) button once. This displays the track on/off screen.
- (3) Use the **19** (▼, ▲) buttons to select the track you want, and then press the **31** (ENTER) button to toggle it on or off.

7. Repeat steps 2 through 6 as required to record all of the tracks you want.

Deleting Recorder Data

You can use the procedures below to delete an entire recorder song or to delete a specific track of a recorder song.

Deleting a Recorder Song

1. Use the **9** (RECORDER) button to cycle through the recorder modes until the RECORDER lamp is lit (playback mode).

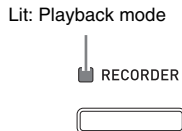

2. While holding down the **18** (FUNCTION) button, press the **9** (RECORDER) button. This displays the recorder song selection screen.
3. Use the **19** (∇ , \wedge) buttons to select the recorder song you want to delete.
4. Hold down the **9** (RECORDER) button until the message "Sure?" appears on the display.
5. Press the **19** (YES) button to delete the recorder song.
 - To cancel the delete operation, press the **19** (NO) button.

Deleting a Recorder Song Track

1. Perform steps 1 through 3 of the procedure under "Deleting a Recorder Song" to select the recorder song that contains the track you want to delete.
2. Press the **30** (\triangleright) button. This displays the track selection screen.
3. Use the **19** (∇ , \wedge) buttons to select the track you want to delete.
4. Hold down the **9** (RECORDER) button until the message "Sure?" appears on the display.
5. Press the **19** (YES) button to delete the track.
 - To cancel the delete operation, press the **19** (NO) button.

Re-recording Part of a Recorder Song (Punch-in Recording)

You can use punch-in recording to re-record a specific part of recorder song that you want to improve or correct.

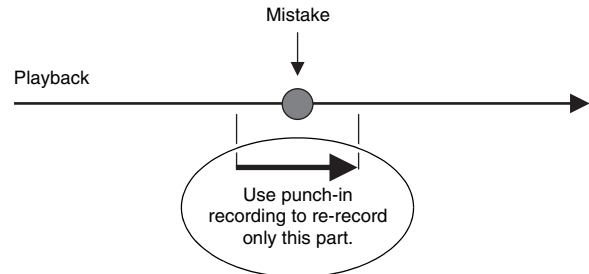

1. Turn on the recorder, enter the record mode, and select the track that contains the section you want to re-record.
 - See step 3 under "Recording to a Specific Track (Part)" (page E-35).
2. Hold down the **9** (RECORDER) button until the punch-in recording screen appears on the display.

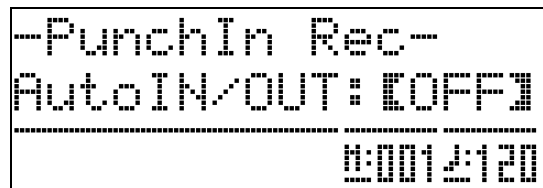

3. Press the **6** (START/STOP) button. This will start playback of the selected track.
4. When playback reaches the point you want to re-record, play the notes and perform the other operations you want. This automatically starts punch-in recording, which will continue until step 5, below.
 - Any one of the following also will start punch-in recording: a pedal or pitch bend wheel operation; pressing the **9** (RECORDER) button;*¹ changing the tone setting; changing the rhythm, or tempo setting*²
 - *1 Press **9** (RECORDER) when you want to start punch-in recording without note input or a setting change.
 - *2 System track only
 - You can perform **3** (REW), **4** (FF), and **5** (PAUSE) button operations during punch-in playback to jump more quickly to the section you want to re-record.

- 5.** To stop punch-in recording, press the **6** (**START/STOP**) button again.

Anything in the track following the point where you pressed the **6** (**START/STOP**) button will be retained as-is.

- If you want to delete all of the data in the track following the section you re-recorded with punch-in recording, press the **9** (**RECORDER**) button in place of the **6** (**START/STOP**) button above.
- If you want to cancel punch-in recording and retain the original (unedited) track data, hold down the **9** (**RECORDER**) button until the display exits the punch-in recording screen.

Specifying the Punch-in Recording Location (Auto Punch-in Recording)

You can use the following procedure to specify a particular range for punch-in recording.

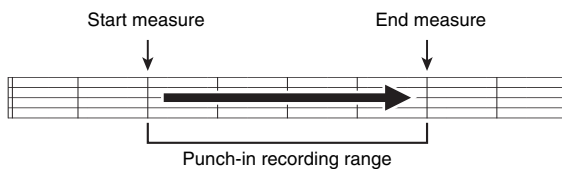

1. Turn on the recorder, enter the record mode, and display the recording setup screen.
 - While holding down the **18** (**FUNCTION**) button, press the **9** (**RECORDER**) button.
2. Use the **29** (**<**) and **30** (**>**) buttons to display “AutoPu.IN”, and then use the **19** (**∨**, **∧**) buttons to select the start measure.
3. Use the **29** (**<**) and **30** (**>**) buttons to display “AutoPu.OUT”, and then use the **19** (**∨**, **∧**) buttons to select the end measure.
 - After selecting the start and end measures, press the **28** (**EXIT**) button to exit the recording setup screen.
4. Select the track that contains the range of measures you want to re-record.
 - See step 3 under “Recording to a Specific Track (Part)” (page E-35).
5. Hold down the **9** (**RECORDER**) button until the punch-in recording screen appears on the display.
6. Press the **19** (**∧**) button to turn on auto punch-in recording.

7. Press the **6** (**START/STOP**) button to start playback.
 - Punch in recording will start from the start measure and stop with the end measure automatically.
8. Play the notes and perform the other operations you want.

■ Performing Punch-in Recording for Areas Smaller than One Measure

Use the procedure below to specify a punch-in recording area that includes a part of a measure.

Example: To re-record from beat 3 of measure 2 up to beat 1 of measure 4

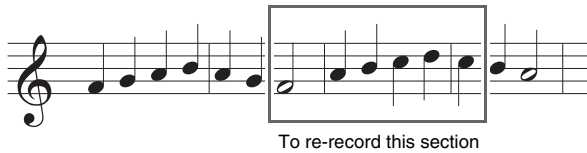

1. Start playback of the song that contains the section you want to re-record.
2. When playback reaches the beginning of the section you want to re-record, press the **2** (**REPEAT**) button.
3. When playback reaches the end of the section you want to re-record, press the **2** (**REPEAT**) button again.
4. Press the **6** (**START/STOP**) button to stop playback.
5. Turn on the recorder and select the track that contains the section you want to re-record.
 - For information about selecting a track, see step 3 under “Recording to a Specific Track (Part)” (page E-35).
6. Hold down the **9** (**RECORDER**) button until the punch-in recording screen appears on the display.
7. Press the **19** (**^**) button to turn on auto punch-in recording.
8. Press the **2** (**REPEAT**) button to turn on repeat.
9. Press the **6** (**START/STOP**) button.

This starts punch-in playback from the measure before the location (start point) you specified in step 2, above.

 - Punch-in recording starts automatically when playback reaches the start point and ends automatically when it reaches the location you specified in step 3 (end point).

Other Settings

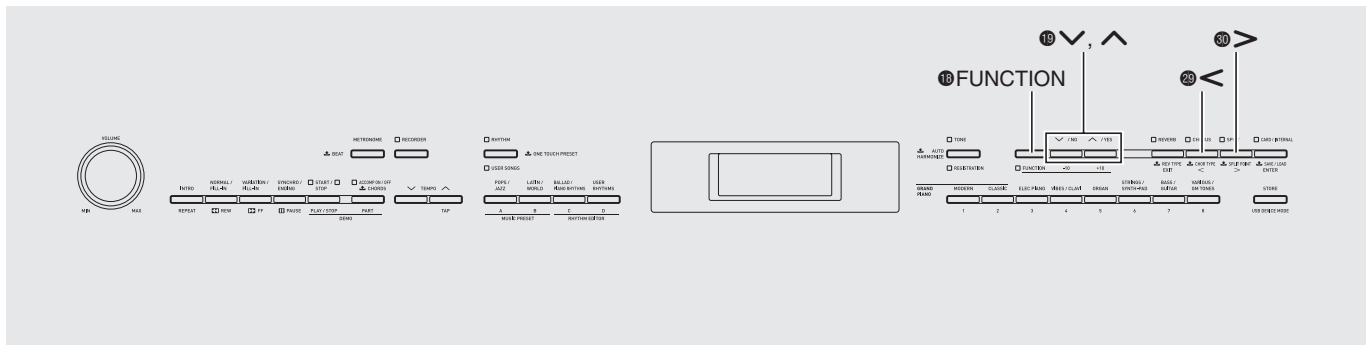

You can use the settings in this section to adjust the tuning and touch of the keyboard, to configure pedal and MIDI settings, and to configure other parameters in order to tailor Digital Piano operation to your particular needs.

Configuring Settings

1. Press the **18** (FUNCTION) button.

The FUNCTION lamp will light and the function screen will appear on the display. (See table below.)

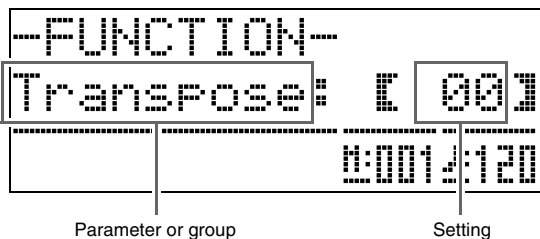

2. Use the **29** (<) and **30** (>) buttons to select one of the parameters (1 through 8) shown in the table below.

- Parameters 4 through 8 actually are parameter groups. After selecting a group, press the **31** (ENTER) button, and then use buttons **29** (<) and **30** (>) to select the parameter you want.
- Short cut buttons also are available for accessing a parameter directly after you press the **18** (FUNCTION) button, without going through the menu. See the "Shortcut Button" column in the table below for the applicable shortcut button of each parameter.

3. Use the **19** (∨, ∧) buttons to change the setting of the currently selected parameter.

- To return to the function screen, press the **28** (EXIT) or **18** (FUNCTION) button.

NOTE

- Holding down the **18** (FUNCTION) button while you press the **19** (∨, ∧) buttons in step 3 will scroll the setting in steps of 10.
- You also can use the **18** (FUNCTION) button for faster scrolling while changing the tone number, rhythm number, and other scrollable settings.
- Keep the **18** (FUNCTION) button depressed while pressing a **19** (∨, ∧) button for high-speed scrolling. Releasing the **18** (FUNCTION) button first can result in another unintended setting being changed.

No.	Parameter	Display Name	Description	Settings	Shortcut Button*
1	Keyboard Key (Transpose)	Transpose	Adjusts keyboard tuning by semitone units.	-12 to 00 to 12 semitones	20
2	Keyboard Fine Tuning (Tuning)	Tune	Adjusts keyboard tuning by cent (1 semitone = 100 cents) units.	-99 to 00 to 99 cents	21
3	Keyboard Touch (Touch Response)	Touch	Adjusts keyboard touch.	Off: Off 1: Strong sound even with light pressure 2: Normal 3: Normal sound even with strong pressure	22
4	Volume Level Group	Volume			24
4-1	Layered Tone Volume (Layer Balance)	LayerBal.	Adjusts the volume level of the layered tone without changing the keyboard main tone.	-24 to 00 to 24	-
4-2	Auto Accompaniment Volume	AccompVol.	Adjusts the volume level of Auto Accompaniment without changing the keyboard tone volume level.	00 to 42	18 - 11
4-3	Song Volume	SongVol.	Adjusts the volume level of user song playback without changing the keyboard tone volume level.	00 to 42	18 - 11
4-4	Metronome Volume	MetroVol.	See page E-15.	00 to 42	18 - 8
5	Temperament/Effect Group	Tmpr/Effect			25
5-1	Temperament	Temper.	Changes the temperament of the keyboard and Auto Accompaniment from the standard equal temperament to another tuning more suitable for playing classics, etc. • Pressing a keyboard key while the temperament screen is displayed will make the pressed key the base note of the temperament.	<Temperaments> 00: Equal / 01: Pure Major / 02: Pure Minor / 03: Pythagorean / 04: Kimberger 3 / 05: Werckmeister / 06: Mean-Tone / 07: Rast / 08: Bayati / 09: Hijaz / 10: Saba / 11: Dashti / 12: Chahargah / 13: Segah / 14: Gurjari Todi / 15: Chandrakauns / 16: Charukeshi <Base notes> C to B (12 types)	-
5-2	Accompaniment Temperament	AccompTmpr	Turn this setting off to play Auto Accompaniment patterns using standard equal temperament (00: Equal), regardless of the temperament setting currently selected with the Temperament parameter (5-1).	Off, On	-
5-3	Stretch Tuning	Stretch	Sharpens high notes and flattens low notes to achieve stretch tuning. Turn off this setting to play with normal (non-stretch) tuning.	Off, On	-
5-4	Brilliance	Brilliance	See page E-12.	-3 to 0 to 3	-
5-5	Acoustic Resonance	AcoResona.	Reproduces the acoustic resonance that occurs when the damper pedal is depressed on a grand piano. No acoustic resonance is applied when this setting is turned off.	Off, On	-
5-6	Octave Shift	OctShift	See page E-12.	U1 : -2 to 0 to 2 U2 : -2 to 0 to 2 L1 : -2 to 0 to 2	18 - 17
5-7	Duet Mode	Duet	See page E-15.	Off, On	18 - 30

* 18 - 11 in this column means, "While holding down 18, press 11."

No.	Parameter	Display Name	Description	Settings	Shortcut Button*
6 Song Playback/Card Group Play/CARD					26
6-1	Pre-count	PreCount	Turn on this setting for an audible count before starting playback of a user song or a song on a memory card.	Off, On	–
6-2	Song Repeat	SongRepeat	Turn on this setting to repeat play a user song or a song on a memory card.	Off, On	18 – 2
6-3	Card Folder	CARD Folder	See page E-53.	(Folder Name)	18 – 13 to 15
6-4	Formatting a Memory Card	CARD FORMAT	See page E-45.	–	18 – 31
6-5	Card File Delete	File DELETE	See page E-47.	–	–
6-6	Card File Rename	File RENAME	See page E-48.	–	–
7 MIDI Group MIDI					27
7-1	Keyboard Channel	KeyboardCh	Selects the keyboard channel, which is the channel used to send MIDI data corresponding to Digital Piano keyboard play to an external device.	01 to 16	–
7-2	Accomp MIDI Out	AccompOut	Turn on this setting to send MIDI data corresponding to Auto Accompaniment to an external device.	Off, On	–
7-3	MIDI In Chord Judge	ChordJudge	Select whether chord input should be performed when an Auto Accompaniment chord keyboard MIDI note on message is received.	Off, On	–
7-4	Local Control	LocalCtl.	Turn off this setting to have keyboard notes sent to an external device without being sounded by the Digital Piano.	Off, On	–

* 18 – 11 in this column means, “While holding down 18, press 11.”

No.	Parameter	Display Name	Description	Settings	Shortcut Button*
8	Other Parameters Group	General			28
8-1	Display Contrast	Contrast	Adjusts the contrast of the Digital Piano's display.	00 to 16	-
8-2	Soft/Sostenuto Pedal Jack Setting	Ped.Assign	Specifies whether the pedal unit connected to the SOFT/SOSTENUTO jack is a soft pedal or a sostenuto pedal. • See page E-15 for details about the two pedal types.	SFT : Soft pedal SOS : Sostenuto pedal	-
8-3	Half Pedal Effect	HalfPedal	Adjusts the amount of the pedal effect applied when the damper pedal is pressed part way.	00 to 42	-
8-4	Pitch Bend Range	BendRange	Specifies the amount of pitch bend applied when the pitch bend wheel is rotated all the way up or down.	00 to 12 semitones	-
8-5	Panel Lock	PanelLock	Turn on to lock the Digital Piano's control panel to prevent unauthorized or accidental operation. • This setting is disabled in the Duet Mode, while the recorder is on, or while Auto Accompaniment, a song, or the metronome is playing.	Off, On	-
8-6	Setting Backup	BackUp	Switching this setting from off to on will save various Digital Piano settings in effect at that time, and restore them the next time the Digital Piano is turned on. • This operation is disabled in the Duet Mode, while the recorder is on, or while Auto Accompaniment, a song, or the metronome is playing.	Off, On	-

* **18** – **11** in this column means, "While holding down **18**, press **11**."

Using a Memory Card

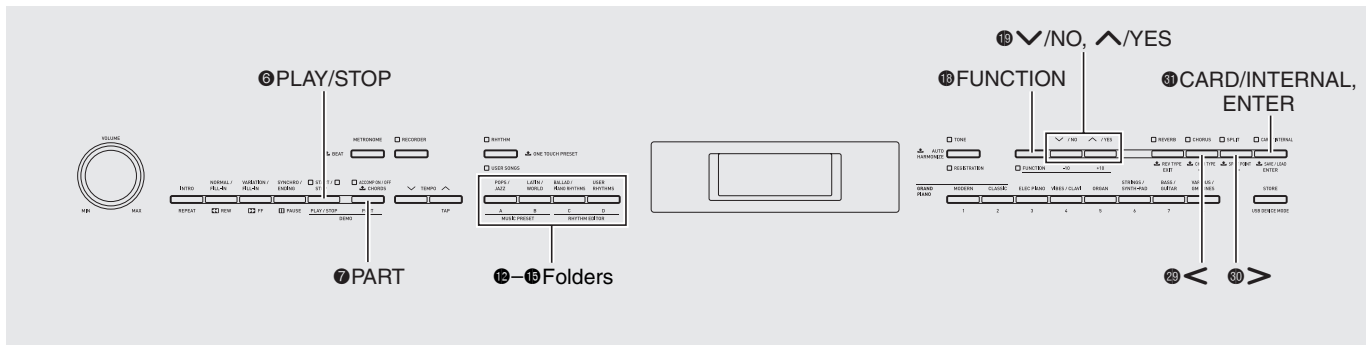

You can use the procedures in this section to transfer edited Auto Accompaniment data, recorder data, and other data from the Digital Piano to a commercially available SD memory card for storage. You also can use a memory card to transfer standard MIDI files (SMF), and accompaniment data you downloaded from the CASIO website from your computer to Digital Piano memory. Once you do, you can use them as user songs and user rhythms.

- Use a memory card with a capacity of 2GB or less. Use of a card with a capacity that is greater than 2GB or other types of memory cards is not supported.
- In this manual, mentions of a “memory card” refer to an SD memory card.

Types of Data

Data Type	Description (File Name Extension)	Supported Operations	
		Save to Memory Card	Load from Memory Card
User rhythms (page E-21)	Auto Accompaniment data edited with this Digital Piano (AC7)	○	○
User songs (page E-25)	One of the following two types of music data 1. CASIO format data (CM2) 2. Standard MIDI files (MID) SMF Format 0 or Format 1	-	○
User Music Presets (page E-28)	Music Preset data edited on this Digital Piano (MPS)	○	○
Recorder songs (page E-34)	Song data recorded on this Digital Piano (CSR)	○*	○
Registration (page E-32)	Tone and rhythm setup settings (CR6)	○	○

* Can be saved as a standard MIDI file (SMF format 0).

Card and Card Slot Precautions

IMPORTANT!

- Be sure to observe the precautions provided in the documentation that comes with the memory card.
- Memory cards have a write-protect switch. Use it when you want to protect the data on the card from accidental deletion.
- Avoid using a memory card under the following conditions. Such conditions can corrupt data stored on the memory card.
 - Areas subjected to high temperature, high humidity, or corrosive gas
 - Areas subjected to strong electrostatic charge and digital noise
- Never touch the contacts of a memory card when loading it or removing it from the Digital Piano.
- Never eject the memory card while data is being written to or loaded from it. Doing so can corrupt the data on the memory card and damage the memory card slot.
- Never insert anything besides a memory card into the card slot. Doing so creates the risk of malfunction.
- Electrostatic charge from your fingers or the memory card to the card slot can cause malfunction of the Digital Piano. If this happens, turn the Digital Piano off and then back on again.
A memory card can become quite warm after very long use in the memory card slot. This is normal and does not indicate malfunction.

Loading and Removing a Memory Card

IMPORTANT!

- A memory card must be positioned correctly when being loaded into the Digital Piano. Trying to force an improperly oriented memory card into the slot can damage the memory card and the slot.

1. With the top of the memory card facing upwards (so you can see it), carefully insert it into the Digital Piano's memory card slot (33) until stops with a click.

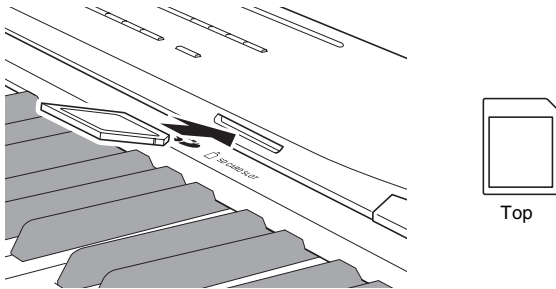

2. To remove the memory card first press it into the slot further.

This will cause the memory card to disengage and eject partially. Pull the memory card the rest of the way out of the slot.

Formatting a Memory Card

IMPORTANT!

- Format a memory card before using it for the first time.
- Before formatting a memory card, make sure it does not have any valuable data stored on it.
- The memory card format operation performed by this Digital Piano is a "quick format". If you want to completely delete all of the data on the memory card, format it on your computer or some other device.

1. Insert the memory card you want to format into the Digital Piano's memory card slot.

Make sure the write-protect switch of the memory card is not in the write-protect position so writing is enabled.

2. While holding down the 18 (FUNCTION) button, press the 31 (CARD/INTERNAL) button.

This displays the format screen.

```

=Play/CARD=
CARD FORMAT >ENT
  
```

3. Press the 31 (ENTER) button.

This will display a confirmation message (SURE?).

- If you want to cancel the format operation, press the 19 (NO) or 23 (EXIT) button.

4. Press the 19 (YES) button.

- The message "Please Wait" will remain on the display while the format operation is being performed. Do not perform any Digital Piano operation while this message is on the display. "Complete" appears on the display after formatting is complete.

Saving Digital Piano Data to a Memory Card

Use the following procedure to save Digital Piano data to a memory card.

- Recorder songs can be saved as a standard MIDI file (SMF format 0).
- User songs (downloaded songs, etc.) cannot be saved to a memory card.

1. Insert a memory card into the Digital Piano's memory card slot.
2. Select the data you want to save to the memory card.

To select this type of data:*1	Do this:
User rhythms	Select from among user rhythms 001 through 010 (page E-21).
User Music Preset	Select from among user Music Preset 001 through 050 (page E-28).
Recorder songs	Select from among recorder songs 1 through 5 (page E-34).
Registrations*2	Press the 17 (REGISTRATION) button so its lower lamp is lit.

*1 For more information about data types, see page E-44.

*2 All registration data (8 banks × 12 areas) is saved in a single file.

3. Hold down the **31** (CARD/INTERNAL) button until the "LOAD" screen appears for the data you selected.
 - You can cancel the LOAD/SAVE operation any time by pressing the **29** (EXIT) button.
4. Press the **30** (>) button to switch to the "SAVE" screen for the data you selected.
 - If you are saving a recorder song to a standard MIDI file (SMF), press the **30** (>) button again so "SMF" is displayed on the right side of the screen.

5. Use the **19** (∨, ∧) buttons to select the file number (01 to 99) you want to assign to the data when it is saved to the memory card.

- The file number is the final two characters of the file name* that appears on the display. By changing this within the range of 01 to 99 for each save, up to 99 files of the same data type can be stored on the memory card.

* The first six characters of the file name indicate the data type as shown below. These characters are fixed and cannot be changed.

Data Type	File Name (** = file number)
User rhythms	USRRHY**
User Music Preset	USRMPS**
Recorder songs	RECSNG**
Registrations	REGIST**

6. Press the **31** (ENTER) button.

- The message "Please Wait" will remain on the display while the save operation is being performed. Do not perform any Digital Piano operation while this message is on the display. "Complete" appears on the display after data save is complete.
- If there already is a file with the same name on the memory card, a message (Replace?) will appear asking if you want to replace it with the new data. Press the **19** (YES) button to overwrite or the **19** (NO) button to cancel the save operation.

■ Memory Card Data Storage

The above procedure stores Digital Piano data in a folder named MUSICDAT on the memory card.

- The MUSICDAT folder is created automatically when you format the memory card on the Digital Piano (page E-45).
- Note that files not in the MUSICDAT folder cannot be loaded, deleted, or renamed by this Digital Piano. You also will not be able to load or delete any file stored in any subfolder inside the MUSICDAT folder.

Loading Data from a Memory Card

You can use the procedure below to load data from a memory card into Digital Piano memory.

IMPORTANT!

- Make sure that all of the data you want to load is in the MUSICDAT folder on the memory card. Note that if you put data into a music data play-only folder on a memory card (such as the MUSIC__B folder), you will no longer be able to load that file into Digital Piano memory.

1. Insert the memory card into the Digital Piano's memory card slot.
2. Select the data you want to load.

To load this type of data*	Do this:
User rhythms	Select from among user rhythms 001 through 010 (page E-21).
User songs	Select from among user songs 001 through 010 (page E-25).
User Music Preset	Select from among user Music Presets 001 through 050 (page E-28).
Recorder songs	Select from among recorder songs 1 through 5 (page E-34).
Registrations	Press the 17 (REGISTRATION) button so its lower lamp is lit.

* For more information about data types, see page E-44.

3. Hold down the **31** (CARD/INTERNAL) button until the "LOAD" screen appears for the data you selected.
 - You can cancel the LOAD/SAVE operation any time by pressing the **23** (EXIT) button.
4. Use the **19** (∨, ∧) buttons to select the file you want.
5. Press the **31** (ENTER) button.
 - The message "Please Wait" will remain on the display while the load operation is being performed. Do not perform any Digital Piano operation while this message is on the display. "Complete" appears on the display after data loading is complete.
 - If there already is a file with the same name on the in Digital Piano memory, a message (Replace?) will appear asking if you want to replace it with the new data. Press the **19** (YES) button to overwrite or the **19** (NO) button to cancel the load operation.

Deleting Memory Card Data

Use the following procedure to delete memory card data (files).

1. Insert the memory card into the Digital Piano's memory card slot.
2. While holding down the **18** (FUNCTION) button, press the **31** (CARD/INTERNAL) button.

This displays the memory card format screen (page E-45).
3. Press the **30** (>) button.

This displays the file delete screen.
4. Press the **31** (ENTER) button.

This displays a screen for selecting data for deletion.
5. Use the **19** (∨, ∧) buttons to select the file you want.
6. Press the **31** (ENTER) button.

This will display a confirmation message (SURE?).

 - If you want to cancel the delete operation, press the **19** (NO) or **23** (EXIT) button.
7. Press the **19** (YES) button.
 - The message "Please Wait" will remain on the display while the delete operation is being performed. Do not perform any Digital Piano operation while this message is on the display. "Complete" appears on the display after deletion is complete.

Renaming a Memory Card File

Use the following procedure to change the file name of a file on a memory card.

1. Insert the memory card into the Digital Piano's memory card slot.
2. While holding down the **18 (FUNCTION)** button, press the **31 (CARD/INTERNAL)** button.
This displays the memory card format screen (page E-45).
3. Press the **30 (>)** button twice so "File RENAME" is displayed.
4. Press the **31 (ENTER)** button.
This displays a screen for changing the file name.
5. Use the **19 (∨, ∧)** buttons to select the file you want.
6. Use the **30 (>)** and **29 (<)** buttons to move the flashing cursor to the character you want to change, and then use the **19 (∨, ∧)** buttons to change the character.

- The characters you can select are shown below.

0	1	2	3	4	5	6	7	8	9
A	B	C	D	E	F	G	H	I	J
K	L	M	N	O	P	Q	R	S	T
U	V	W	X	Y	Z	\$	&	_	'
()	-	^	{	}	@	~	`	

7. After the file name is the way you want, press the **30 (ENTER)** button.

This will display a confirmation message (SURE?).

- If you want to cancel the renaming operation, press the **19 (NO)** or **28 (EXIT)** button.

8. Press the **19 (YES)** button.

- The message "Please Wait" will remain on the display while the rename operation is being performed. Do not perform any Digital Piano operation while this message is on the display. "Complete" appears on the display after renaming is complete.

Playing Back a Song from a Memory Card

You can use the procedure below to play back a user song (page E-25) stored on a memory card without loading the song into Digital Piano memory.

■ Memory Card Folders

Formatting a memory card on the Digital Piano will automatically create the four folders shown below. You put playback song data into any one of the folders. You can use the four folders to group your music data by family member, genre, or some other categories. Use buttons **12** through **15** (A through D) to select a folder.

Folder Name	Button Assignment
MUSICDAT	12 (A)
MUSIC__B	13 (B)
MUSIC__C	14 (C)
MUSIC__D	15 (D)

1. Store the music data you want to play back in one of the memory card folders.
2. Insert the memory card into the Digital Piano's memory card slot.
3. Press the **31 (CARD/INTERNAL)** button.
4. Press one of the folder selection buttons (**12** through **15**) to select the card folder you want. This will display the song number and song name of the first song in the folder you selected.
5. Use the **19 (∨, ∧)** buttons to select the song you want.
6. Press the **6 (PLAY/STOP)** button.
This will start playback.
 - Each press of **6 (PLAY/STOP)** starts and stops playback.
 - Fast forward, fast reverse, tempo changes, and other operations are the same as those during playback of a user song in Digital Piano memory. For details, see "Listening to Songs Loaded from an External Source" (page E-25).
7. To quit memory card data playback, press the **31 (CARD/INTERNAL)** button.

Playing Back All of the Songs in a Folder

Use the procedure below to select one of the four folders on a memory card and play back all of the songs in the folder in succession.

1. While holding down the **7 (PART)** button, press the **6 (PLAY/STOP)** button.
This will start tone demo tune playback (page E-24).
2. Press the **31 (CARD/INTERNAL)** button.
This will switch from tone demo tune playback to card tune playback.
 - While playback is in progress, you can use the **12** through **15** buttons (Folder A through Folder D) to switch playback to another folder.
 - To stop playback, press the **6 (PLAY/STOP)** button.

Assigning a Different Folder to a Folder Selection Button

You can use the following procedure to assign different folders to folder selection buttons **13**, **14**, and **15**.

1. While holding down the **16 (FUNCTION)** button, press the folder selection button (**13**, **14**, or **15**) whose folder assignment you want to change.
 - This displays the folder assignment screen for the button you press.
2. Use the **19 (∨, ∧)** buttons to select the folder you want to assign to the button.
 - You can select any folder on the memory card.
3. After selecting a folder, you can rename it if you want.
 - Perform steps 6 through 8 of the procedure under “Renaming a Memory Card File” (page E-48) to rename the folder.

Saving Data to Digital Piano Memory (Internal Area) Instead of a Memory Card

Even when you do not have a memory card loaded in the Digital Piano’s memory card slot, you can save up to about 16MB of data in the Digital Piano’s internal memory area. You also can load and delete internal memory area data using the same procedures that you use with a memory card.

1. Remove the memory card from the Digital Piano’s memory card slot (page E-45).
 - Removing the memory card from the slot enables internal memory area data operations (save, load, delete, rename, playback).

To do this	Perform this operation
Save data to the internal memory area	From step 2 under “Saving Digital Piano Data to a Memory Card” on page E-46
Load data from the internal memory area	From step 2 under “Loading Data from a Memory Card” on page E-47
Delete data from the internal memory area	From step 2 under “Deleting Memory Card Data” on page E-47
Rename a file in the internal memory area	From step 2 under “Renaming a Memory Card File” on page E-48
Play back a song in the internal memory area	From step 3 under “Playing Back a Song from a Memory Card” on page E-48 <ul style="list-style-type: none"> • The operation in step 4 of the above procedure is not possible in the case of internal memory area song playback.

Error Messages

One of the error messages below appears on the display when a problem occurs.

- All mentions of “memory card” in the following table refer to an SD memory card.

Display Message	Cause	Required Action
Convert	There is not enough Digital Piano memory available to convert a recorder song (page E-34) to SMF data and store it on the memory card.	Reduce the size of the recorder song data by deleting unneeded tracks (page E-37), if there are any.
Format	<ol style="list-style-type: none"> 1. The current memory card format is not compatible with this Digital Piano. 2. The memory card capacity is greater than 2GB. 3. There is something wrong with the memory card. 	<ol style="list-style-type: none"> 1. Format the memory card on the Digital Piano (page E-45). 2. Use a memory card with a capacity of 2GB or less. 3. Use a different memory card.
MediaFull	<ol style="list-style-type: none"> 1. There is not enough room available on the memory card. 2. There is not enough room available in Digital Piano memory. 	<ol style="list-style-type: none"> 1. Delete some of the files on the memory card to make room for new data (page E-47), or use a different card. 2. Delete some or all user data from Digital Piano memory to make room for new data.
Media R/W	<ol style="list-style-type: none"> 1. Memory card data is corrupted. 2. Digital Piano memory is corrupted. 	<ol style="list-style-type: none"> 1. Use a different memory card. 2. Back-up Digital Piano memory data by copying it to your computer, and then turn the Digital Piano off and then back on again. <ul style="list-style-type: none"> • Note that you may not be able to back-up Digital Piano data in certain cases.
No Card	<ol style="list-style-type: none"> 1. The memory card is not loaded correctly in the Digital Piano’s memory card slot. 2. The memory card was removed while some operation was in progress. 	<ol style="list-style-type: none"> 1. Correctly load the memory card into the memory card slot. 2. Do not remove the memory card while any operation is in progress.
No Data	You tried to save a Digital Piano user area (user rhythm, user rhythm song, etc.) that does not contain any data to the memory card.	Select a user area that contains data.
No File	<ol style="list-style-type: none"> 1. There is no MUSICDAT folder (page E-46) on the memory card. 2. There is no loadable or playable data in the MUSICDAT folder, or there is no playable data in a song playback folder (MUSIC__B, etc.) 	<ol style="list-style-type: none"> 1. Create a MUSICDAT folder on the memory card or format the memory card on the Digital Piano (page E-45). 2. Move the file you want to load or play into the memory card’s MUSICDAT folder. For song playback, you can place the song data into any one of the following folders: MUSIC__B, MUSIC__C, or MUSIC__D.
Not SMF01	You are attempting to play back SMF Format 2 song data.	This Digital Piano supports playback of SMF Format 0 or Format 1 only.
Protect	The memory card is write-protected.	Use the memory card’s write protect switch to enable writing.
ReadOnly	A read-only file with the same name you are trying to use is already stored on the memory card.	<ul style="list-style-type: none"> • Use a different name to save the new file. • Remove the read-only attribute from the existing file and overwrite it with the new file. • Use a different memory card.
SizeOver	<ol style="list-style-type: none"> 1. The data on the memory card is too big to play. 2. The data you are trying to load is too large. 	<ol style="list-style-type: none"> 1. This Digital Piano supports playback of song data files with a maximum size of about 320 kbytes. 2. The following is the maximum data size (per data item) when loading data into Digital Piano memory. <ul style="list-style-type: none"> User rhythm: Approximately 40KB User Song: 320KB User Music Preset: Approximately 8KB
WrongDat	<ol style="list-style-type: none"> 1. The memory card data is corrupted. 2. The memory card contains data that is not supported by this Digital Piano. 	—

Connecting to a Computer

You can connect the Digital Piano to a computer and exchange MIDI data between them. You can send play data from the Digital Piano to music software running on your computer, or you can send MIDI data from your computer to the Digital Piano for playback.

Minimum Computer System Requirements

The following shows the minimum computer system requirements for sending and receiving MIDI data. Check to make sure that your computer complies with these requirements before connecting the Digital Piano to it.

● Operating System

Windows® XP (SP2 or later)*1

Windows Vista® *2

Windows® 7 *3

Mac OS® X (10.3.9, 10.4.11, 10.5.8 or later, 10.6.6 or later)

*1: Windows XP Home Edition

Windows XP Professional (32-bit)

*2: Windows Vista (32-bit)

*3: Windows 7 (32-bit, 64-bit)

● USB port



IMPORTANT!

- Never connect to a computer that does not conform to the above requirements. Doing so can cause problems with your computer.

Connecting the Digital Piano to Your Computer



IMPORTANT!

- Make sure you follow the steps of the procedure below exactly. Connecting incorrectly can make data send and receive impossible.

1. Turn off the Digital Piano and then start up your computer.
 - Do not start up the music software on your computer yet!
2. After starting up your computer, use a commercially available USB cable to connect it to the Digital Piano.

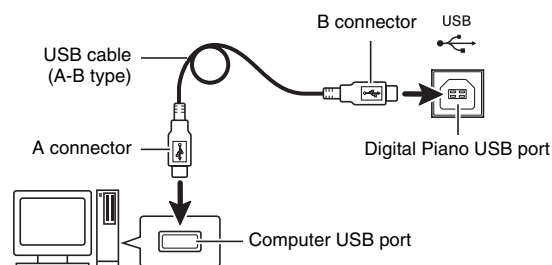

3. Turn on the Digital Piano.
 - If this is the first time you are connecting the Digital Piano to your computer, the driver software required to send and receive data will be installed on your computer automatically.
4. Start up your computer's music software.
5. Configure the music software settings to select one of the following as the MIDI device.
 - CASIO USB-MIDI : (For Windows Vista, Windows 7, Mac OS X)
 - USB Audio Device: (For Windows XP)
 - For information about how to select the MIDI device, see the user documentation that comes with the music software you are using.



IMPORTANT!

- Be sure to turn on the Digital Piano first before starting up your computer's music software.

 NOTE

- Once you are able to connect successfully, there is no problem with leaving the USB cable connected when you turn off your computer and/or Digital Piano.
- This Digital Piano conforms to General MIDI Level 1 (GM).
- For detailed specifications and connections that apply to MIDI data send and receive by this Digital Piano, see the latest support information provided by the website at the following URL.
<http://world.casio.com/>

Using MIDI

What is MIDI?

The letters MIDI stand for Musical Instrument Digital Interface, which is the name of a worldwide standard for digital signals and connectors that makes it possible to exchange musical data between musical instruments and computers (machines) produced by different manufacturers.

For details about the MIDI specifications of this Digital Piano, see the “MIDI Implementation” document at the website located at the URL below.

<http://world.casio.com/>

 NOTE

- You can alter the Digital Piano’s MIDI setup by changing the MIDI data send channel or other settings. For details, see “MIDI Group” (page E-42).
- Use a separately available or commercially available MIDI cable to connect the MIDI terminals of your Digital Piano and another electronic musical instrument for exchange of MIDI data.

Transferring Data between the Digital Piano and a Computer

You can use the procedure below to transfer edited Auto Accompaniment data, recorder data, and other data from the Digital Piano to a computer for storage. You also can transfer standard MIDI files (SMF), as well as Auto Accompaniment data you downloaded from the CASIO website from your computer to Digital Piano memory.

■ Data Types Supported for Data Transfer

The types of data that can be exchanged with a computer are the same as those that can be saved to an SD memory card from the Digital Piano (page E-44).*

- * Recorder songs (page E-34) cannot be converted to SMF data for storage on a computer.

 IMPORTANT!

- Turning off the Digital Piano while data is being saved or loaded can cause all data currently stored in Digital Piano memory (recorded songs, etc.) to be deleted. Take care so power is not turned off accidentally during data save and load operations. If data is deleted, it will take longer than normal for the Digital Piano to power up the next time you turn it on (page E-9).

1. Remove the memory card from the Digital Piano’s memory card slot (page E-45).
 - You will not be able to transfer data between the Digital Piano and a computer if a card is in the memory card slot.
2. Perform steps 1 through 3 under “Connecting the Digital Piano to Your Computer” to connect the piano to your computer (page E-51).

3. While holding down the **18** (FUNCTION) button, press the **32** (USB DEVICE MODE) button.

This will enter the storage mode, which enables data transfer with the connected computer. The **18** (FUNCTION) button lamp will flash and the display will appear as shown below.



- To exit the storage mode at any time, press the **18** (FUNCTION) button. This is the only button operation that is supported while the Digital Piano is in the storage mode.
- You will not be able to enter the storage mode while any one of the following operations is in progress. Metronome, Auto Accompaniment, song playback, recorder (on), Auto Accompaniment editing, Music Preset editing, data transfer between the Digital Piano and card

4. If your computer is running Windows XP, double-click “My Computer”.*

Under “Devices with Removable Storage”, you should be able to see a folder representing Digital Piano memory or the memory card loaded in the Digital Piano (see below).

* Windows Vista, Windows 7: Double-click “Computer”.
Mac OS: Skip step 4 and double-click “PIANO” on your Mac desktop.

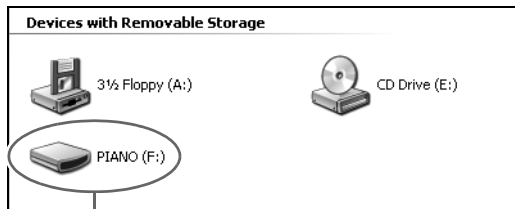

PIANO drive (Digital Piano memory)

5. Double-click “PIANO”.

You now should see five data folders, one for each data type.

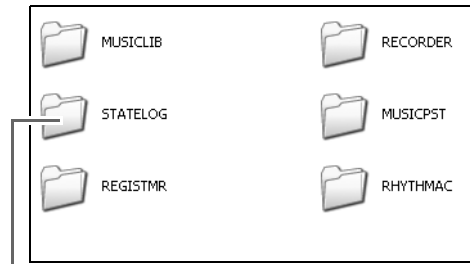

This folder is not a data folder. You should not try to use it for normal Digital Piano operation.

6. Referring to the table below, open the folder that corresponds to the type of data you want to transfer.

To load this type of data	Open this data folder	Data File Name
User rhythms (page E-21)	RHYTHMAC	BIDRHYnn.AC7 (nn: 01 to 10)
User songs (page E-25)	MUSICLIB	BIDSNGnn.MID (nn: 01 to 10) (SMF Format 0 or Format 1) BIDSNGnn.CM2 (nn: 01 to 10) (CASIO format)
User Music Presets (page E-28)	MUSICPST	BIDMPSnn.MPS (nn: 01 to 50)
Recorder songs (page E-34)	RECORDER	BIDRECnn.CSR (nn: 01 to 05)
Registration (page E-32)	REGISTMR	BIDREGAL.CR6

- Data types and contents are the same as those when saving Digital Piano data to or loading it from an SD memory card. See “Using a Memory Card” (page E-44) for more information.

7. File name extensions (.MID, .CM2, etc.) are not displayed under initial default Windows settings. Perform the procedure below to turn on display of file name extensions.

- (1) Open any one of the folders shown above.
- (2) Perform one of the following operations to display folder information.
 - Windows XP:
On the [Tools] menu at the top of the folder window, select [Folder Options].
 - Windows Vista, Windows 7:
On the left side of the folder window, click [Organize] and then select [Folder and Search Options].
- (3) On the Folder Information window, click the [View] tab.
- (4) Under "Advanced Settings", clear the "Hide extensions for known file types" check box and then click [OK].

8. After opening a data folder, perform either of the following operations to transfer data.

8-1. To transfer data from Digital Piano memory to a computer, perform the required operation on your computer to copy the data from the Digital Piano folder you opened in step 6 of this procedure to another location on your computer.

8-2. To load data from your computer to Digital Piano memory, first copy the data you want to load to the data folder you opened. Next, rename the file as shown in the "Data File Name" * column in the table under step 6 of this procedure.

* The value you assign for "nn" in the data file name in this case specifies the user number (user rhythm, user song, recorder song, user preset) you want the data to be assigned to.

Example: Renaming downloaded song data to BIDSNG04.CM2 to the MUSICLIB folder will make the data user song 004.

9. Press the **18** (FUNCTION) button to exit the storage mode.

- If you are using a Macintosh, drag the PIANO folder to the Trash and then press the Digital Piano's **18** (FUNCTION) button.



IMPORTANT!

- The message "ERROR, DATA EXCHANGE" will appear on the display if a problem occurs during data transfer. If this happens, check the message in the "STATELOG" folder (page E-53) on the "PIANO" drive. Next find the same message in the table on page E-50 of this manual to determine the cause of the problem and what action you need to take to avoid it.

Playing Back User Song Data by Copying It to the PIANO Drive

You can use the procedure below at any time to copy user song data to the PIANO drive (without putting it in the MUSICLIB folder) for simplified playback on the Digital Piano.

- When you copy a user song data file to the MUSICLIB folder, you need to rename it according to specified format (page E-53, step 6). You do not need to rename the file if you use the procedure below.

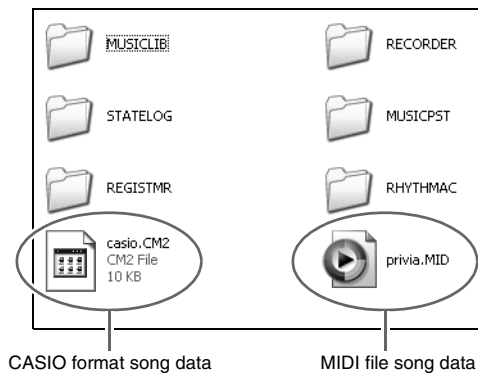

1. Perform the previous procedure to copy the user song data file to the PIANO drive.
2. Press the **31** (CARD/INTERNAL) button.
This will cause the button's lamp to light and will the display the song number and song name of the first song on the PIANO drive.
3. Use the **19** (**∨**, **∧**) buttons to select the song you want to play.
4. Press the **6** (PLAY/STOP) button.
This starts playback of the selected song.
 - Each press of the **6** (PLAY/STOP) button toggles between play and stop.
 - Fast forward, fast reverse, tempo change, and other operations are the same as those during playback of a loaded user song and a song file on a memory card.
5. When you are finished playing back songs, press the **31** (CARD/INTERNAL) button.

Using Your Digital Piano as a Memory Card Reader

You can display the contents of the memory card currently loaded in the Digital Piano's card slot and perform copy, delete, and other card operations from your computer.

1. Insert the memory card into the Digital Piano's memory card slot.
2. Perform the procedure starting from step 2 on page E-52.

In step 4 of the procedure, "SD_MMC" will appear in place of "PIANO". You can double-click "SD_MMC" to display the contents of the card loaded in the Digital Piano card slot, and change it as you like.

■ Using Auto Accompaniment Data from the CASIO Website

You can download other model Auto Accompaniment data from the "Internet Data Expansion System" of the CASIO Music Site (<http://music.casio.com/>) and transfer it to Digital Piano memory.

NOTE

- Since the accompaniment data is for other models, you may experience some abnormalities when playing it on this model.

Copyrights

The rights of creators and copyright holders of music, images, computer programs, databases, and other data are protected by copyright laws. You are allowed to reproduce such works for personal or non-commercial use only. For any other purpose, all reproduction (including data format conversion), modification, transfer of reproductions, distribution over a network, or any other use without permission of the copyright holder exposes you to claims for damages and criminal prosecution for copyright infringement and violation of the author's personal rights. Be sure to reproduce and otherwise use copyrighted works only in accordance with applicable copyright laws.

Reference

Troubleshooting

Problem	Cause	Action	See Page
No sound is produced when I press a keyboard key.	<ol style="list-style-type: none"> The VOLUME controller is set to "MIN". Headphones or an adaptor plug is plugged into one of the PHONES jacks. 	<ol style="list-style-type: none"> Rotate the VOLUME controller more towards "MAX". Disconnect whatever is connected to the PHONES jack. 	<p>☞ E-9</p> <p>☞ E-6</p>
The pitch of the Digital Piano is off.	<ol style="list-style-type: none"> The Digital Piano's key setting is something other than "00". Digital Piano tuning is incorrect. A non-standard temperament setting is being used. Octave shift is enabled. 	<ol style="list-style-type: none"> Change the key setting to "00", or turn Digital Piano power off and then back on again. Adjust Digital Piano tuning, or turn the piano off and then back on again. Change the temperament setting to "00:Equal", which is the standard modern tuning. Change the octave shift setting to 0. 	<p>☞ E-41</p> <p>☞ E-41</p> <p>☞ E-41</p> <p>☞ E-12</p>
Tones and/or effects sound strange. Turning power off and then back on again does not eliminate the problem. <i>Example: Note intensity does not change even though I alter key pressure.</i>	The "Setting Backup" feature is turned on.	Turn off "Setting Backup". Next, turn power off and then back on again.	☞ E-43
I cannot transfer data after connecting the Digital Piano to a computer.	—	<ol style="list-style-type: none"> Check to make sure that the USB cable is connected to the Digital Piano and computer, and that the correct device is selected with your computer's music software. Turn off the Digital Piano and then exit the music software on your computer. Next, turn the Digital Piano back on and then restart the music software on your computer. 	☞ E-51
I cannot record chord accompaniment data on my computer.	Accomp MIDI Out is turned off.	Turn on Accomp MIDI Out.	☞ E-42
I cannot store data to a memory card or load data from a memory card.	—	See "Error Messages" on page E-50.	—
Playback stops part way through while transferring song data from my computer.	Digital noise from the USB cable or power cord caused data communication your computer and Digital Piano to be interrupted.	Stop song playback, disconnect the USB cable from the Digital Piano, and then reconnect it. Next, try playing back the song again. If this does not solve the problem, quit the MIDI software you are using, disconnect the USB cable from the Digital Piano, and then reconnect it. Next, restart the MIDI software and then try playing back the song again.	☞ E-51
A tone's quality and volume sounds slightly different depending where it is played on the keyboard.	This is an unavoidable result of the digital sampling process,* and does not indicate malfunction. * Multiple digital samples are taken for the low range, middle range, and high range of the original musical instrument. Because of this, there may be a very slight difference in tonal quality and volume between sample ranges.		
When I press a button, the note that is sounding cuts out momentarily or there is a slight change in how effects are applied.	Performing a button operation while playing with the Duet Mode, Auto Accompaniment, the recorder, or other functions can cause such phenomena when the Digital Piano switches internal tone effects. It does not indicate malfunction.		
Even though I play on different ranges of the keyboard, the notes do not change octaves.	The ranges of certain tones are limited, which means that octaves change normally up to a certain low note or high note. With such a tone, the notes of the lowest octave will be repeated to the left of the lowest possible note, and the highest octave will be repeated to the right of the highest possible note. This is due do limitations in the range of the original musical instrument for each tone, and does not indicate malfunction of the Digital Piano.		

Product Specifications

Model	PX-330BK/PX-330WE
Keyboard	88-key piano keyboard, with Touch Response (3 types)
Maximum Polyphony	128 notes
Tones	250 (with Layer and Split)
Effects	Reverb (4 types), Chorus (4 types), Brilliance (–3 to 0 to 3), Acoustic Resonance
Metronome	<ul style="list-style-type: none"> • Beats per measure: 0, 2, 3, 4, 5, 6 • Tempo Range: 20 to 255
Duet	Adjustable tone range: 0 to 3 octaves for the left keyboard; –4 to –1 octaves for the right keyboard
Auto Accompaniment	<ul style="list-style-type: none"> • Built-in Rhythms: 180 • User Rhythms: Up to 10 (Approximately 40KB* maximum per rhythm) • One Touch Presets: 180 types • Auto Harmonize: 12 types
Demo Songs	8 songs (tone demo songs)
User Songs	Up to 10 songs (320KB* maximum per song)
Music Presets	Built-in Presets: 300 User Presets: Up to 50 (Approximately 8KB* maximum per preset)
Registration	(4 rhythm areas + 8 tone areas) × 8 banks
Recorder	<ul style="list-style-type: none"> • Functions: Real-time recording, playback • Number of Songs: 5 • Number of Tracks: 17 (System Track + Tracks 01 through 16) • Capacity: Approximately 50,000 notes total (Up to approximately 10,000 notes per song) • Punch-in recording
Pedals	Damper, Soft/Sostenuto (switchable)
Other Functions	<ul style="list-style-type: none"> • Transpose: ±1 octave (–12 to 00 to 12) • Tuning: A4 = 440.0 Hz ±99 cents • Octave Shift: ±2 octaves • Temperaments: 17 types • Stretch Tune • Panel Lock
MIDI	16 multi-timbre received, GM Level 1 standard
Pitch Bend Wheel	Pitch Bend Range: 00 to 12 semitones
SD Memory Card	<ul style="list-style-type: none"> • SD memory card slot • Supported SD Memory Cards: Up to 2GB • Functions: SMF playback, file storage, file recall, card format
Inputs/Outputs	<ul style="list-style-type: none"> • PHONES jacks: Stereo mini jacks × 2 • Pedal Jacks: Standard jacks × 2 • MIDI OUT/IN terminals • LINE OUT R, L/MONO jacks: Standard jacks × 2 Output impedance: 2.3KΩ Output voltage: 1.8V (RMS) MAX • LINE IN R, L/MONO jacks: Standard jacks × 2 Input impedance: 9.0KΩ Input voltage: 200mV • Power: 12V DC • USB port: Type B • Pedal connector (for optional SP-32 only)
Speakers	[13cm × 6cm (rectangular)] × 2 + φ5cm × 2 (Output: 8.0W + 8.0W)
Power Requirements	AC Adaptor: AD-A12150LW
Power Consumption	12V --- 18W
Dimensions	132.2 (W) × 28.6 (D) × 13.5 (H) cm (52 ¹ / ₁₆ × 11 ¹ / ₄ × 5 ⁵ / ₁₆ inch)
Weight	Approximately 11.6kg (25.6lbs)

* Based on 1KB = 1024bytes, 1MB = 1024² bytes

- Specifications and designs are subject to change without notice.

Operating Precautions

Be sure to read and observe the following operating precautions.

■ Location

Avoid the following locations for this product.

- Areas exposed to direct sunlight and high humidity
- Areas subjected to temperature extremes
- Near a radio, TV, video deck, or tuner
- The above devices will not cause malfunction of the product, but the product can cause interference in the audio or video of a nearby device.

■ User Maintenance

- Never use benzine, alcohol, thinner, or other chemical agents to clean the product.
- To clean the product or its keyboard, wipe with a soft cloth moistened in a weak solution of water and a mild neutral detergent. Wring all excess moisture from the cloth before wiping.

■ Included and Optional Accessories

Use only accessories that are specified for use with this product. Use of unauthorized accessories creates the risk of fire, electric shock, and personal injury.

■ Weld Lines

Lines may be visible on the exterior of the product. These are "weld lines" that result from the plastic molding process. They are not cracks or scratches.

■ Musical Instrument Etiquette

Always be aware of others around you whenever using this product. Be especially careful when playing late at night to keep the volume at levels that do not disturb others. Other steps you can take when playing late at night are closing windows and using headphones.

- Any reproduction of the contents of this manual, either in part or its entirety, is prohibited. Except for your own, personal use, any other use of the contents of this manual without the consent of CASIO is prohibited under copyright laws.
- IN NO EVENT SHALL CASIO BE LIABLE FOR ANY DAMAGES WHATSOEVER (INCLUDING, WITHOUT LIMITATION, DAMAGES FOR LOSS OF PROFITS, BUSINESS INTERRUPTION, LOSS OF INFORMATION) ARISING OUT OF THE USE OF OR INABILITY TO USE THIS MANUAL OR PRODUCT, EVEN IF CASIO HAS BEEN ADVISED OF THE POSSIBILITY OF SUCH DAMAGES.
- The contents of this manual are subject to change without notice.

■ AC Adaptor Handling Precautions

- Use a power outlet that is easily accessible so you can unplug the AC adaptor when a malfunction occurs or whenever else you need to do so.
- The AC adaptor is intended for indoor use only. Do not use it where it might be exposed to splashing or moisture. Do not place any container, such as a flower vase, that contains liquid on the AC adaptor.
- Store the AC adaptor in a dry place.
- Use the AC adaptor in an open, well-ventilated area.
- Never cover the AC adaptor with newspaper, a table cloth, a curtain, or any other similar item.
- Unplug the AC adaptor from the power outlet if you do not plan to use the Digital Piano for a long time.
- Never try to repair the AC adaptor or modify it in any way.
- AC adaptor operating environment
Temperature: 0 to 40°C
Humidity: 10% to 90% RH

Output polarity: 

AC Adaptor Handling Precautions

Model: AD-A12150LW

1. Read these instructions.
2. Keep these instructions on hand.
3. Heed all warnings.
4. Follow all instructions.
5. Do not use this product near water.
6. Clean only with a dry cloth.
7. Do not install near radiators, heat registers, stoves, or any other source of heat (including amplifiers).
8. Use only attachments and accessories specified by the manufacturer.
9. Refer all servicing to qualified service personnel. Servicing is required after any of the following occurs: when the product is damaged, when the power supply cord or plug is damaged, when liquid is spilled into the product, when a foreign object falls into the product, when the product is exposed to rain or moisture, when the product does not operate normally, when the product is dropped.
10. Do not allow the product to be exposed to dripping or splashing liquid. Do not place any object containing liquid on the product.
11. Do not allow the electrical load output to exceed the label rating.
12. Make sure the surrounding area is dry before plugging into a power source.
13. Make sure the product is oriented correctly.
14. Unplug the product during lightning storms or when you do not plan to use it for a long time.
15. Do not allow product ventilation openings to become blocked. Install the product in accordance with the manufacturer's instructions.
16. Take care the power cord is located where it will not be stepped upon or bent severely, particularly in locations close to plugs and convenience receptacles, and in locations where it exits from the product.
17. The AC adaptor should be plugged into a power outlet as close to the product as possible to allow immediate disconnection of the plug in case of emergency.

The symbol below is an alert indicating un-insulated hazardous voltage inside the product's enclosure, which may be sufficient to constitute the risk of electric shock to users.



The symbol below is an alert indicating the presence of important operating and maintenance (servicing) instructions in the documentation that accompanies the product.



Appendix/Apéndice

Tone List/Lista de tonos

Group Name/ Nombre del grupo	Group Number/ Número de grupo	Sequential Number/ Número secuencial	Tone Name/ Nombre del tono	Program Change/ Cambio de programa	Bank Select MSB/ MSB de Selección de banco	Acoustic Resonance/ Resonancia acústica
GRAND PIANO MODERN						
	001	001	GRAND PIANO MODERN	0	48	○
	002	002	GRAND PIANO VARIATION	0	50	○
	003	003	ROCK PIANO	1	48	○
	004	004	LA PIANO	1	49	○
	005	005	MODERN PIANO	1	50	○
	006	006	DANCE PIANO	1	51	○
GRAND PIANO CLASSIC						
	001	007	GRAND PIANO CLASSIC	0	49	○
	002	008	MELLOW PIANO	0	51	○
	003	009	HONKY-TONK	3	48	○
	004	010	OCTAVE PIANO	3	49	○
	005	011	STRINGS PIANO	0	52	○
	006	012	PIANO PAD	0	53	○
ELEC PIANO						
	001	013	ELEC.PIANO 1	4	48	
	002	014	ELEC.PIANO 2	5	48	
	003	015	60'S E.PIANO	4	51	
	004	016	E.GRAND 80	2	48	
	005	017	DYNO ELEC.PIANO	4	49	
	006	018	FM ELEC.PIANO	5	49	
	007	019	MELLOW E.PIANO	4	50	
	008	020	POP ELEC.PIANO	5	50	
	009	021	SYNTH-STR.E.PIANO	4	52	
VIBES/CLAVI						
	001	022	VIBRAPHONE	11	48	
	002	023	CLAVI	7	48	
	003	024	HARPSICHORD	6	48	
	004	025	COUPLED HARPSICHORD	6	49	
	005	026	MARIMBA	12	48	
	006	027	CHORUS VIBRAPHONE	11	49	
ORGAN						
	001	028	ROCK ORGAN 1	16	49	
	002	029	JAZZ ORGAN	17	48	
	003	030	DRAWBAR ORGAN	16	48	
	004	031	ROTARY DRAWBAR	16	50	
	005	032	ROTARY ORGAN	16	51	
	006	033	PERC.ORGAN	17	49	
	007	034	70'S ORGAN	17	50	
	008	035	OVERDRIVE ORGAN	16	52	
	009	036	TREMOLO ORGAN	16	53	
	010	037	ROCK ORGAN 2	18	48	
	011	038	ELEC.ORGAN	16	54	
	012	039	CHURCH ORGAN	19	48	
	013	040	CHAPEL ORGAN	19	49	
STRINGS/SYNTH-PAD						
	001	041	STRINGS	49	48	
	002	042	STRING ENSEMBLE	48	48	
	003	043	SYNTH-STRINGS	50	48	
	004	044	70'S SYNTH-STR.	50	49	
	005	045	80'S SYNTH-STR.	50	50	
	006	046	VIOLIN SECTION	40	48	
	007	047	CHOIR	52	48	
	008	048	SYNTH-VOICE	54	48	
	009	049	SYNTH-PAD	90	48	
	010	050	FANTASY	88	48	
	011	051	NEW AGE	88	49	
	012	052	WARM PAD	89	48	
	013	053	WARM VOX	89	49	
	014	054	POLYSYNTH PAD	90	49	
	015	055	ATMOSPHERE PAD	99	48	
BASS/GUITAR						
	001	056	ACOUSTIC BASS	32	48	
	002	057	RIDE BASS	32	49	
	003	058	FINGERED BASS 1	33	48	
	004	059	FINGERED BASS 2	33	49	
	005	060	FINGERED BASS 3	33	50	
	006	061	PICKED BASS	34	48	
	007	062	TRANCE BASS	38	48	
	008	063	NYLON STR.GUITAR	24	48	

Group Name/ Nombre del grupo	Group Number/ Número de grupo	Sequential Number/ Número secuencial	Tone Name/ Nombre del tono	Program Change/ Cambio de programa	Bank Select MSB/ MSB de Selección de banco	Acoustic Resonance/ Resonancia acústica
	009	064	STEEL STR.GUITAR 1	25	48	
	010	065	STEEL STR.GUITAR 2	25	49	
	011	066	STEEL STR.GUITAR 3	25	50	
	012	067	JAZZ GUITAR	26	48	
	013	068	CLEAN GUITAR	27	49	
	014	069	CHORUS CLEAN GUITAR	27	48	
	015	070	CRUNCH ELEC.GUITAR 1	27	50	
	016	071	CRUNCH ELEC.GUITAR 2	27	51	
	017	072	OVERDRIVE GUITAR	29	48	
VARIOUS/GM TONES						
	001	073	BREATHY ALTO SAX	65	49	
	002	074	BREATHY TENOR SAX	66	49	
	003	075	ALTO SAX	65	48	
	004	076	TENOR SAX	66	48	
	005	077	CLARINET	71	48	
	006	078	FLUTE	73	48	
	007	079	TRUMPET	56	48	
	008	080	TROMBONE	57	48	
	009	081	STEREO BRASS	61	48	
	010	082	BRASS SECTION	61	49	
	011	083	SYNTH-BRASS	62	48	
	012	084	80'S SYNTH-BRASS	62	49	
	013	085	SAW LEAD	81	48	
	014	086	MELLOW SAW LEAD	81	49	
	015	087	SQUARE LEAD	80	48	
	016	088	ER HU	110	56	
	017	089	YANG QIN 1	15	56	
	018	090	YANG QIN 2	15	57	
	019	091	DI ZI	72	56	
	020	092	ZHENG	107	56	
	021	093	SHENG	109	56	
	022	094	SUO NA	111	57	
	023	095	XIAO	77	56	
	024	096	PI PA 1	105	56	
	025	097	PI PA 2	105	57	
	026	098	SITAR	104	56	
	027	099	TANPURA	104	57	
	028	100	HARMONIUM	20	56	
	029	101	SANTUR	15	58	
	030	102	SAROD	105	58	
	031	103	SHANAI	111	56	
	032	104	SARANGI	110	57	
	033	105	KANUN	15	59	
	034	106	QUD	105	59	
	035	107	NEY	72	57	
	036	108	ARABIC ORGAN	16	56	
	037	109	GM PIANO 1	0	0	○
	038	110	GM PIANO 2	1	0	○
	039	111	GM PIANO 3	2	0	
	040	112	GM HONKY-TONK	3	0	
	041	113	GM E.PIANO 1	4	0	
	042	114	GM E.PIANO 2	5	0	
	043	115	GM HARPSICHORD	6	0	
	044	116	GM CLAVI	7	0	
	045	117	GM CELESTA	8	0	
	046	118	GM GLOCKENSPIEL	9	0	
	047	119	GM MUSIC BOX	10	0	
	048	120	GM VIBRAPHONE	11	0	
	049	121	GM MARIMBA	12	0	
	050	122	GM XYLOPHONE	13	0	
	051	123	GM TUBULAR BELL	14	0	
	052	124	GM DULCIMER	15	0	
	053	125	GM ORGAN 1	16	0	
	054	126	GM ORGAN 2	17	0	
	055	127	GM ORGAN 3	18	0	
	056	128	GM PIPE ORGAN	19	0	
	057	129	GM REED ORGAN	20	0	
	058	130	GM ACCORDION	21	0	
	059	131	GM HARMONICA	22	0	
	060	132	GM BANDONEON	23	0	
	061	133	GM NYLON STR.GUITAR	24	0	

Group Name/ Nombre del grupo	Group Number/ Número de grupo	Sequential Number/ Número secuencial	Tone Name/ Nombre del tono	Program Change/ Cambio de programa	Bank Select MSB/ MSB de Selección de banco	Acoustic Resonance/ Resonancia acústica
	062	134	GM STEEL STR.GUITAR	25	0	
	063	135	GM JAZZ GUITAR	26	0	
	064	136	GM CLEAN GUITAR	27	0	
	065	137	GM MUTE GUITAR	28	0	
	066	138	GM OVERDRIVE GT	29	0	
	067	139	GM DISTORTION GT	30	0	
	068	140	GM GT HARMONICS	31	0	
	069	141	GM ACOUSTIC BASS	32	0	
	070	142	GM FINGERED BASS	33	0	
	071	143	GM PICKED BASS	34	0	
	072	144	GM FRETLESS BASS	35	0	
	073	145	GM SLAP BASS 1	36	0	
	074	146	GM SLAP BASS 2	37	0	
	075	147	GM SYNTH-BASS 1	38	0	
	076	148	GM SYNTH-BASS 2	39	0	
	077	149	GM VIOLIN	40	0	
	078	150	GM VIOLA	41	0	
	079	151	GM CELLO	42	0	
	080	152	GM CONTRABASS	43	0	
	081	153	GM TREMOLO STRINGS	44	0	
	082	154	GM PIZZICATO	45	0	
	083	155	GM HARP	46	0	
	084	156	GM TIMPANI	47	0	
	085	157	GM STRINGS 1	48	0	
	086	158	GM STRINGS 2	49	0	
	087	159	GM SYNTH-STRINGS 1	50	0	
	088	160	GM SYNTH-STRINGS 2	51	0	
	089	161	GM CHOIR AAHS	52	0	
	090	162	GM VOICE DOO	53	0	
	091	163	GM SYNTH-VOICE	54	0	
	092	164	GM ORCHESTRA HIT	55	0	
	093	165	GM TRUMPET	56	0	
	094	166	GM TROMBONE	57	0	
	095	167	GM TUBA	58	0	
	096	168	GM MUTE TRUMPET	59	0	
	097	169	GM FRENCH HORN	60	0	
	098	170	GM BRASS	61	0	
	099	171	GM SYNTH-BRASS 1	62	0	
	100	172	GM SYNTH-BRASS 2	63	0	
	101	173	GM SOPRANO SAX	64	0	
	102	174	GM ALTO SAX	65	0	
	103	175	GM TENOR SAX	66	0	
	104	176	GM BARITONE SAX	67	0	
	105	177	GM OBOE	68	0	
	106	178	GM ENGLISH HORN	69	0	
	107	179	GM BASSOON	70	0	
	108	180	GM CLARINET	71	0	
	109	181	GM PICCOLO	72	0	
	110	182	GM FLUTE	73	0	
	111	183	GM RECORDER	74	0	
	112	184	GM PAN FLUTE	75	0	
	113	185	GM BOTTLE BLOW	76	0	
	114	186	GM SHAKUHACHI	77	0	
	115	187	GM WHISTLE	78	0	
	116	188	GM OCARINA	79	0	
	117	189	GM SQUARE LEAD	80	0	
	118	190	GM SAW LEAD	81	0	
	119	191	GM CALLIOPE	82	0	
	120	192	GM CHIFF LEAD	83	0	
	121	193	GM CHARANG	84	0	
	122	194	GM VOICE LEAD	85	0	
	123	195	GM FIFTH LEAD	86	0	
	124	196	GM BASS+LEAD	87	0	
	125	197	GM FANTASY	88	0	
	126	198	GM WARM PAD	89	0	
	127	199	GM POLYSYNTH	90	0	
	128	200	GM SPACE CHOIR	91	0	
	129	201	GM BOWED GLASS	92	0	
	130	202	GM METAL PAD	93	0	
	131	203	GM HALO PAD	94	0	
	132	204	GM SWEEP PAD	95	0	
	133	205	GM RAIN DROP	96	0	
	134	206	GM SOUND TRACK	97	0	
	135	207	GM CRYSTAL	98	0	
	136	208	GM ATMOSPHERE	99	0	
	137	209	GM BRIGHTNESS	100	0	
	138	210	GM GOBLINS	101	0	
	139	211	GM ECHOES	102	0	

Group Name/ Nombre del grupo	Group Number/ Número de grupo	Sequential Number/ Número secuencial	Tone Name/ Nombre del tono	Program Change/ Cambio de programa	Bank Select MSB/ MSB de Selección de banco	Acoustic Resonance/ Resonancia acústica
	140	212	GM SF	103	0	
	141	213	GM SITAR	104	0	
	142	214	GM BANJO	105	0	
	143	215	GM SHAMISEN	106	0	
	144	216	GM KOTO	107	0	
	145	217	GM THUMB PIANO	108	0	
	146	218	GM BAGPIPE	109	0	
	147	219	GM FIDDLE	110	0	
	148	220	GM SHANAI	111	0	
	149	221	GM TINKLE BELL	112	0	
	150	222	GM AGOGO	113	0	
	151	223	GM STEEL DRUMS	114	0	
	152	224	GM WOOD BLOCK	115	0	
	153	225	GM TAIKO	116	0	
	154	226	GM MELODIC TOM	117	0	
	155	227	GM SYNTH-DRUM	118	0	
	156	228	GM REVERSE CYMBAL	119	0	
	157	229	GM GT FRET NOISE	120	0	
	158	230	GM BREATH NOISE	121	0	
	159	231	GM SEASHORE	122	0	
	160	232	GM BIRD	123	0	
	161	233	GM TELEPHONE	124	0	
	162	234	GM HELICOPTER	125	0	
	163	235	GM APPLAUSE	126	0	
	164	236	GM GUNSHOT	127	0	
	165	237	STANDARD SET 1	0	120	
	166	238	STANDARD SET 2	1	120	
	167	239	STANDARD SET 3	2	120	
	168	240	STANDARD SET 4	3	120	
	169	241	ROOM SET	8	120	
	170	242	HIP-HOP SET	9	120	
	171	243	POWER SET	16	120	
	172	244	ELECTRONIC SET	24	120	
	173	245	SYNTH SET 1	25	120	
	174	246	SYNTH SET 2	30	120	
	175	247	TRANCE SET	31	120	
	176	248	JAZZ SET	32	120	
	177	249	BRUSH SET	40	120	
	178	250	ORCHESTRA SET	48	120	

NOTE

- Acoustic resonance (page E-41) is applied only to tones indicated by “○”.
- While sequential numbered tone 065 (STEEL STR.GUITAR 2) or 066 (STEEL STR.GUITAR 3) is selected, pressing multiple keys on the far left side of the keyboard will produce a guitar strumming sound. It does not indicate malfunction.
- See the “Drum Assignment List” (page A-3) for the percussion instrument assigned to each keyboard key when a drum set (Sequential Number 237 to 250) is selected.

NOTA

- La resonancia acústica (página S-42) se aplica solamente a los tonos indicados mediante “○”.
- Cuando los tonos secuenciales número 065 (STEEL STR. GUITAR 2) o 066 (STEEL STR. GUITAR 3) estén seleccionados, si presiona múltiples teclas en el extremo izquierdo del teclado producirá un sonido de rasgueo de guitarra. Esto no es ningún signo de anomalía.
- Consulte la “Lista de asignación de batería” (página A-3) para saber cuáles son los instrumentos de percusión asignados a cada tecla cuando se selecciona un ajuste de batería (números secuenciales 237 a 250).

Drum Assignment List/Lista de sonidos de batería

Key/Note Number Número de clave/nota	STANDARD SET 1	STANDARD SET 2	STANDARD SET 3	STANDARD SET 4	ROOM SET	HIP-HOP SET	POWER SET	ELECTRONIC SET	SYNTH SET 1	SYNTH SET 2	TRANCE SET	JAZZ SET	BRUSH SET	ORCHESTRA SET
E1 28	High Q	←	←	←	←	←	←	←	←	←	←	←	←	Closed Hi-Hat
F1 29	Slap	←	←	←	←	←	←	←	←	←	←	←	←	Pedal Hi-Hat
F1 29	Scratch Push	←	←	←	←	←	←	←	←	←	←	←	←	Open Hi-Hat
G1 31	Scratch Pull	←	←	←	←	←	←	←	←	←	←	←	←	Ride Cymbal 1
G1 31	Sticks	←	←	←	←	←	←	←	←	←	←	←	←	←
A1 33	Square Click	←	←	←	←	←	←	←	←	←	←	←	←	←
A1 33	Metronome Click	←	←	←	←	←	←	←	←	←	←	←	←	←
B1 35	Metronome Bell	←	←	←	←	←	←	←	←	←	←	←	←	←
B1 35	Standard1 Kick 1	Standard2 Kick 2	Standard3 Kick 2	Standard4 Kick 2	Room Kick 2	Hip-Hop Kick 2	Power Kick 2	Elec. Kick 2	Synth1 Kick 2	Synth2 Kick 2	Trance Kick 2	Jazz Kick 2	Brush Kick 2	Jazz Kick 1
C2 36	Standard1 Kick 1	Standard2 Kick 1	Standard3 Kick 1	Standard4 Kick 1	Room Kick 1	Hip-Hop Kick 1	Power Kick 1	Elec. Kick 1	Synth1 Kick 1	Synth2 Kick 1	Trance Kick 1	Jazz Kick 1	Brush Kick 1	Concert BD
D2 38	Standard1 Snare 1	Standard2 Snare 1	Standard3 Snare 1	Standard4 Snare 1	Room Snare 1	Hip-Hop Snare 1	Power Snare 1	Elec. Snare 1	Synth1 Snare 1	Synth2 Snare 1	Trance Snare 1	Jazz Snare 1	Brush Snare 1	Concert SD
E2 40	Hand Clap	←	Standard3 Hand Clap	←	←	Hip-Hop Hand Clap	←	←	Synth1 Hand Clap	←	Trance Hand Clap	←	Brush Slap	Castanets
F2 41	Standard1 Snare 2	Standard2 Snare 2	Standard3 Snare 2	Standard4 Snare 2	Room Snare 2	Hip-Hop Snare 2	Power Snare 2	Elec. Snare 2	Synth1 Snare 2	Synth2 Snare 2	Trance Snare 2	Jazz Snare 2	Brush Snare 2	Concert SD
F2 42	Low Tom 2	←	Standard3 Low Tom 2	←	Room Low Tom 2	←	Room Low Tom 2	Elec. Low Tom 2	Synth1 Low Tom 2	Synth2 Low Tom 2	Trance Closed Hi-Hat	←	←	Timpani F
G2 43	Closed Hi-Hat	Standard2 Closed Hi-Hat	Standard3 Closed Hi-Hat	Standard4 Closed Hi-Hat	Room Low Tom 1	Hip-Hop Closed Hi-Hat	Room Low Tom 1	Elec. Low Tom 1	Synth1 Closed Hi-Hat 1	Synth2 Closed Hi-Hat 1	Trance Open Hi-Hat	←	←	Timpani G
A2 44	Pedal Hi-Hat	Standard2 Pedal Hi-Hat	Standard3 Pedal Hi-Hat	Standard4 Pedal Hi-Hat	Room Mid Tom 2	Hip-Hop Pedal Hi-Hat	Room Mid Tom 2	Elec. Mid Tom 2	Synth1 Closed Hi-Hat 2	Synth2 Closed Hi-Hat 2	Trance Open Hi-Hat 1	←	←	Timpani G
A2 45	Mid Tom 2	←	Standard3 Mid Tom 2	←	Room Mid Tom 2	←	Room Mid Tom 2	Elec. Mid Tom 2	Synth1 Mid Tom 2	Synth2 Mid Tom 2	Trance Open Hi-Hat 2	←	←	Timpani A
B2 46	Open Hi-Hat	Standard2 Open Hi-Hat	Standard3 Open Hi-Hat	Standard4 Open Hi-Hat	Room Mid Tom 1	Hip-Hop Open Hi-Hat	Room Mid Tom 1	Elec. Mid Tom 1	Synth1 Open Hi-Hat	Synth2 Open Hi-Hat	Trance Open Hi-Hat 2	←	←	Timpani A
B2 47	Mid Tom 1	←	Standard3 Mid Tom 1	←	Room High Tom 2	←	Room High Tom 2	Elec. High Tom 2	Synth1 Mid Tom 1	Synth2 Mid Tom 1	Trance Open Hi-Hat 2	←	←	Timpani B
C3 48	High Tom 2	←	Standard4 High Tom 2	←	Room High Tom 1	←	Room High Tom 1	Elec. High Tom 1	Synth1 High Tom 2	Synth2 High Tom 2	Trance Open Hi-Hat 2	←	←	Timpani c
C3 49	Crash Cymbal 1	←	←	←	Room High Tom 1	←	Room High Tom 1	Elec. High Tom 1	Synth1 High Tom 1	Synth2 High Tom 1	Trance Open Hi-Hat 2	←	←	Timpani c
D3 50	High Tom 1	←	Standard4 High Tom 1	←	Room High Tom 1	←	Room High Tom 1	Reverse Cymbal	Synth1 High Tom 1	←	Trance Tambourine	←	←	Timpani d
E3 52	Ride Cymbal 1	←	←	←	←	←	←	←	Synth1 Ride Cymbal	←	←	←	←	Timpani e
F3 53	Chinese Cymbal	←	←	←	←	←	←	←	←	←	←	←	←	Timpani f
F3 53	Ride Bell	←	←	←	←	←	←	←	Synth1 Tambourine	←	Trance Tambourine	←	←	Timpani f
G3 55	Tambourine	←	←	←	←	←	←	←	←	←	←	←	←	←
G3 55	Splash Cymbal	←	←	←	←	←	←	←	Synth1 Cowbell	Synth1 Cowbell	←	←	←	←
A3 57	Cowbell	←	←	←	←	←	←	←	←	←	←	←	←	←
A3 57	Crash Cymbal 2	←	←	←	←	←	←	←	←	←	←	←	←	←
B3 58	Vibraslap	←	←	←	←	←	←	←	←	←	←	←	←	←
B3 59	Crash Cymbal 1	←	←	←	←	←	←	←	←	←	←	←	←	←
C4 60	Ride Cymbal 2	←	←	←	←	←	←	←	←	←	←	←	←	←
C4 60	High Bongo	←	←	←	←	←	←	←	←	←	←	←	←	←
D4 62	Low Bongo	←	←	←	←	←	←	←	Synth1 High Bongo	←	←	←	←	←
D4 62	Mute High Conga	←	←	←	←	←	←	←	Synth1 Low Bongo	←	←	←	←	←
E4 64	Open High Conga	←	←	←	←	←	←	←	Synth1 Mute Hi Conga	←	←	←	←	←
E4 64	Open Low Conga	←	←	←	←	←	←	←	Synth1 Open Hi Conga	←	←	←	←	←
F4 65	High Timbale	←	←	←	←	←	←	←	Synth1 Open Low Conga	←	←	←	←	←
F4 65	Low Timbale	←	←	←	←	←	←	←	←	←	←	←	←	←
G4 67	High Agogo	←	←	←	←	←	←	←	←	←	←	←	←	←
G4 67	Low Agogo	←	←	←	←	←	←	←	←	←	←	←	←	←
A4 69	Cabasa	←	←	←	←	←	←	←	←	←	←	←	←	←
A4 69	Maracas	←	←	←	←	←	←	←	Synth1 Maracas	Synth1 Maracas	←	←	←	←
B4 71	Short High Whistle	←	←	←	←	←	←	←	←	←	←	←	←	←
C5 72	Long Low Whistle	←	←	←	←	←	←	←	←	←	←	←	←	←
D5 74	Long Guiro	←	←	←	←	←	←	←	←	←	←	←	←	←
D5 74	Long Guiro	←	←	←	←	←	←	←	←	←	←	←	←	←
E5 76	Claves	←	←	←	←	←	←	←	←	←	←	←	←	←
E5 76	High Wood Block	←	←	←	←	←	←	←	Synth1 Claves	Synth1 Claves	←	←	←	←
F5 77	Low Wood Block	←	←	←	←	←	←	←	←	←	←	←	←	←
F5 77	Mute Cuica	←	←	←	←	←	←	←	←	←	←	←	←	←
G5 79	Open Cuica	←	←	←	←	←	←	←	←	←	←	←	←	←
A5 81	Mute Triangle	←	←	←	←	←	←	←	←	←	←	←	←	←
A5 81	Open Triangle	←	←	←	←	←	←	←	←	←	←	←	←	←
B5 83	Shaker	←	←	←	←	←	←	←	←	←	←	←	←	←
B5 83	Jingle Bell	←	←	←	←	←	←	←	←	←	←	←	←	←
C6 84	Bell Tree	←	←	←	←	←	←	←	←	←	←	←	←	←
C6 84	Castanets	←	←	←	←	←	←	←	←	←	←	←	←	←
D6 86	Mute Surdo	←	←	←	←	←	←	←	←	←	←	←	←	←
D6 86	Open Surdo	←	←	←	←	←	←	←	←	←	←	←	←	←
E6 88	Applause 1	←	←	←	←	←	←	←	←	←	←	←	←	←
F6 89	Applause 2	←	←	←	←	←	←	←	←	←	←	←	←	←

• “←” indicates a key is assigned the same tones as it is for STANDARD SET.
 • “←←” indica una clave asignada a los mismos tonos que para STANDARD SET.

Rhythm List/Lista de ritmos

Group Name/ Nombre del grupo	Group Number/ Número de grupo	Sequential Number/ Número secuencial	Rhythm name/ Nombre del ritmo
POPS/JAZZ			
POPS			
001	001	POP 1	POP 1
002	002	POP 2	POP 2
003	003	FAST POP	FAST POP
004	004	FUNK POP	FUNK POP
005	005	POP ROCK	POP ROCK
006	006	6/8 POP	6/8 POP
007	007	FAST SOUL	FAST SOUL
008	008	SLOW SOUL	SLOW SOUL
009	009	60'S SOUL	60'S SOUL
010	010	POP SHUFFLE	POP SHUFFLE
8 BEAT/16 BEAT			
011	011	STRAIGHT 8 BEAT 1	STRAIGHT 8 BEAT 1
012	012	STRAIGHT 8 BEAT 2	STRAIGHT 8 BEAT 2
013	013	FUNK 8 BEAT	FUNK 8 BEAT
014	014	MELLOW 8 BEAT	MELLOW 8 BEAT
015	015	GIUITAR 8 BEAT	GIUITAR 8 BEAT
016	016	8 BEAT	8 BEAT
017	017	8 BEAT POP	8 BEAT POP
018	018	OLDIES 8 BEAT	OLDIES 8 BEAT
019	019	60'S 8 BEAT	60'S 8 BEAT
020	020	16 BEAT	16 BEAT
021	021	16 BEAT SHUFFLE	16 BEAT SHUFFLE
DANCE			
022	022	HIP-HOP	HIP-HOP
023	023	DANCE POP	DANCE POP
024	024	DISCO POP	DISCO POP
025	025	TECHNO POP	TECHNO POP
026	026	TRANCE	TRANCE
027	027	MODERN R&B	MODERN R&B
028	028	MODERN DANCE	MODERN DANCE
029	029	DISCO SOUL	DISCO SOUL
ROCK			
030	030	STRAIGHT ROCK	STRAIGHT ROCK
031	031	SHUFFLE ROCK	SHUFFLE ROCK
032	032	BLUES 1	BLUES 1
033	033	BLUES 2	BLUES 2
034	034	EP BLUES	EP BLUES
035	035	SLOW BLUES	SLOW BLUES
036	036	SOFT ROCK	SOFT ROCK
037	037	LATIN ROCK	LATIN ROCK
038	038	SLOW ROCK	SLOW ROCK
039	039	50'S ROCK	50'S ROCK
040	040	50'S PIANO ROCK	50'S PIANO ROCK
041	041	NEW ORLNS R&R	NEW ORLNS R&R
042	042	60'S ROCK	60'S ROCK
043	043	ROCK	ROCK
044	044	70'S PIANO ROCK	70'S PIANO ROCK
045	045	ROCK WALTZ	ROCK WALTZ
JAZZ			
046	046	SLOW BIG BAND	SLOW BIG BAND
047	047	MIDDLE BIG BAND	MIDDLE BIG BAND
048	048	FAST BIG BAND	FAST BIG BAND
049	049	SWING 1	SWING 1
050	050	SWING 2	SWING 2
051	051	SLOW SWING	SLOW SWING
052	052	JAZZ WALTZ	JAZZ WALTZ
053	053	FOX TROT	FOX TROT
054	054	QUICKSTEP	QUICKSTEP
055	055	JAZZ COMBO 1	JAZZ COMBO 1
EUROPEAN			
056	056	SCHLAGER	SCHLAGER
057	057	POLKA	POLKA
058	058	WALTZ 1	WALTZ 1

Group Name/ Nombre del grupo	Group Number/ Número de grupo	Sequential Number/ Número secuencial	Rhythm name/ Nombre del ritmo
	059	059	WALTZ 2
	060	060	SLOW WALTZ
	061	061	VIENNESE WALTZ
	062	062	FRENCH WALTZ
	063	063	SERENADE
	064	064	TANGO
	065	065	MARCH 1
	066	066	MARCH 2
LATIN/WORLD			
LATIN I			
	001	067	BOSSA NOVA
	002	068	SLOW BOSSA NOVA
	003	069	BEGUINE
	004	070	SAMBA 1
	005	071	SAMBA 2
	006	072	MAMBO
	007	073	RHUMBA
	008	074	CHA-CHA-CHA
	009	075	MERENGUE
	010	076	BOLERO
	011	077	SALSA 1
	012	078	SALSA 2
	013	079	REGGAE
	014	080	POP REGGAE
	015	081	SKA
LATIN II			
	016	082	REGGAETON 1
	017	083	REGGAETON 2
	018	084	CUMBIA
	019	085	CALYPSO
	020	086	FORRO
	021	087	PAGODE
	022	088	BANDA
	023	089	PASILLO
	024	090	ARGENTINE CUMBIA
	025	091	PUNTA
	026	092	BACHATA
COUNTRY			
	027	093	MODERN COUNTRY
	028	094	COUNTRY 8 BEAT
	029	095	COUNTRY BALLAD
	030	096	COUNTRY SHUFFLE
	031	097	FINGER PICKING COUNTRY
	032	098	COUNTRY WALTZ
	033	099	BLUEGRASS
WORLD I			
AMERICAN			
	034	100	DIXIE
	035	101	TEX-MEX
	036	102	FAST GOSPEL
	037	103	SLOW GOSPEL
	038	104	HAWAIIAN
SPANISH/EASTERN EUROPEAN			
	039	105	PASODOBLE
	040	106	CAUCASIAN
	041	107	RUSSIAN CHANSON 1
	042	108	RUSSIAN CHANSON 2
	043	109	POLISH WALTZ
ARABIC/ORIENTAL			
	044	110	SIRTAKI
	045	111	MUS
	046	112	ADANI
	047	113	BALADI
	048	114	KHALIJI
	049	115	MALFOOF

Group Name/ Nombre del grupo	Group Number/ Número de grupo	Sequential Number/ Número secuencial	Rhythm name/ Nombre del ritmo
WORLD II			
INDIAN			
050	116	BHANGRA	
051	117	DADRA	
052	118	GARBA	
053	119	KEHARWA	
054	120	DANDIYA	
055	121	TEEN TAAL	
056	122	BHAJAN	
CHINESE			
057	123	GUANGDONG	
058	124	JIANGNAN	
059	125	BEIJING	
060	126	DONGBEIYANGGE	
061	127	JINGJU	
062	128	HUANGMEIXI	
063	129	QINQIANG	
064	130	YUJU	
065	131	YAOZU	
066	132	DAIZU	
067	133	MIAOZU	
068	134	MENGGU	
069	135	XINJIANG	
070	136	ZANGZU	
SOUTHEAST ASIAN			
071	137	KRONCONG	
072	138	DANGDUT	
JAPANESE			
073	139	ENKA	
BALLAD/PIANO RHYTHMS			
BALLAD			
001	140	PIANO ROCK BALLAD	
002	141	90'S BALLAD	
003	142	MODERN BALLAD	
004	143	ELECTRIC BALLAD	
005	144	SLOW BALLAD 1	
006	145	SLOW BALLAD 2	
007	146	R&B BALLAD	
008	147	16 BEAT BALLAD	
009	148	SOUL BALLAD	
010	149	POP BALLAD 1	
011	150	POP BALLAD 2	
012	151	PIANO WALTZ BALLAD	
013	152	90'S 6/8 BALLAD	
014	153	6/8 BALLAD 1	
015	154	6/8 BALLAD 2	
016	155	ROCK BALLAD	
VARIOUS			
017	156	CHRISTMAS SONG	
018	157	CHRISTMAS WALTZ	
019	158	SCREEN SWING	
020	159	SYMPHONY	
021	160	STR QUARTET	
PIANO RHYTHMS			
022	161	PIANO 8 BEAT	
023	162	PIANO BALLAD 1	
024	163	PIANO BALLAD 2	
025	164	EP BALLAD 1	
026	165	EP BALLAD 2	
027	166	BLUES BALLAD	
028	167	JAZZ COMBO 2	
029	168	JAZZ COMBO 3	
030	169	RAGTIME	
031	170	BOOGIE-WOOGIE	
032	171	PIANO ROCK & ROLL	
033	172	ARPEGGIO 1	
034	173	ARPEGGIO 2	
035	174	ARPEGGIO 3	
036	175	PIANO MARCH 1	

Group Name/ Nombre del grupo	Group Number/ Número de grupo	Sequential Number/ Número secuencial	Rhythm name/ Nombre del ritmo
	037	176	PIANO MARCH 2
	038	177	STRIDE PIANO
	039	178	WALTZ 3
	040	179	WALTZ 4
	041	180	WALTZ 5

 **NOTE**

- Sequential number rhythms 171 through 180 do not sound unless a chord is being played.

 **NOTA**

- Los ritmos secuenciales números 171 al 180 no suenan a menos que se ejecute un acorde.

Music Preset List/Lista de preajustes musicales

Group Name/ Nombre del grupo	Group Number/ Número de grupo	Sequential Number/ Número secuencial	Preset Name/ Nombre de preajuste
A			
POPS			
	1	1	Soft Pop
	2	2	Winter Pop
	3	3	Oldies Pop
	4	4	Alpine Flora
	5	5	Gypsy
	6	6	Rain Pop
	7	7	Movie Waltz
	8	8	Blowin' in
	9	9	Funky Rspct
	10	10	Love Pop
	11	11	Loco
	12	12	Rising Sun
	13	13	Believer
	14	14	Pop Ska
	15	15	Weep Blues
	16	16	Sugar Pop
	17	17	JoyWorldPop
	18	18	My Life
	19	19	Ribbon
	20	20	Blue Love
	21	21	Xmas Pop
	22	22	Close
	23	23	Going On
	24	24	70's Pop
	25	25	West Coast
	26	26	Bossa Pop
	27	27	Radio Pop
	28	28	Crazy Roll
	29	29	Ivory Pop
	30	30	UK Pop
	31	31	Breath You
	32	32	A Feeling
	33	33	Calling
	34	34	Take On
	35	35	The World
	36	36	PlaceOnEarth
	37	37	Mexican Pop
	38	38	Guitar Pop
	39	39	W Up
	40	40	Sign
	41	41	Wonder
	42	42	Hips D Lie
	43	43	Say Right
	44	44	MdrnPopRock
ROCK			
	45	45	Rock Clock
	46	46	Johnny
	47	47	Heartache
	48	48	EP R&R
	49	49	Pop R&B
	50	50	60's Rock 1
	51	51	60's Rock 2
	52	52	60's Rock 3
	53	53	60's Rock 4
	54	54	60's Rock 5
	55	55	Get Rock
	56	56	Honky Rock
	57	57	Wild Rock
	58	58	Alligator
	59	59	The Tiger
	60	60	Pop Rock
	61	61	16Bt Rosa
	62	62	Heat Up
	63	63	Hard Rock
	64	64	Grunge Rock
	65	65	Latin Rock
	66	66	Hanging By
	67	67	R&R
	68	68	Piano R&R
	69	69	Blues
	70	70	8 Bars Blues
	71	71	Riff Rock 1
	72	72	Riff Rock 2
	73	73	Riff Rock 3
DANCE			
	74	74	Disco Freak

Group Name/ Nombre del grupo	Group Number/ Número de grupo	Sequential Number/ Número secuencial	Preset Name/ Nombre de preajuste
	75	75	Funky Clavi
	76	76	Earth Disco
	77	77	70's Disco
	78	78	Disco Lady
	79	79	Staying
	80	80	Upside
	81	81	80's Disco
	82	82	Give You Up
	83	83	Bb Girl
	84	84	Blv Disco
	85	85	Lady M
	86	86	Out Of My H
	87	87	Euro Pop
	88	88	Don't Funk
	89	89	Trance
	90	90	The Escape
JAZZ			
	91	91	Wonderland
	92	92	My Swing
	93	93	Things
	94	94	Angel
	95	95	Time
	96	96	Leaf
	97	97	Blackbird
	98	98	Dolphin
	99	99	Roses
	100	100	Steps
	101	101	RhythmChange
	102	102	Swing Mood
	103	103	The Mood
	104	104	Brown Jug
	105	105	Lullaby
	106	106	Night
	107	107	Street
	108	108	Doll
	109	109	Someday
	110	110	Mode Jazz
	111	111	Train
	112	112	Tea Time
	113	113	Jazz Waltz
	114	114	Home
	115	115	Blues in F
	116	116	Blues in Bb
	117	117	Blues in C
	118	118	II-V
	119	119	II-V-I
	120	120	Minor Blues
B			
CLASSIC			
	1	121	Canon
	2	122	Air G String
	3	123	Je Te Veux
	4	124	Adagio
	5	125	Spring
	6	126	Ave Maria
	7	127	JesusBleibet
	8	128	Symphony 25
	9	129	Symphony 40
	10	130	HungriaDance
	11	131	Eine Kleine
	12	132	Pathetique
	13	133	Moonlight
	14	134	PstlSymphony
	15	135	Ode To Joy
	16	136	Le Cygne
	17	137	Swan Lake
	18	138	Valse Fleurs
	19	139	Habanera
	20	140	Nocturne
	21	141	Etude
	22	142	FrenchCancan
	23	143	Fantaisielmp
	24	144	Humoresque
	25	145	Pavane
	26	146	Hope & Glory
	27	147	Moldau
	28	148	FromNewWorld
	29	149	Reverie

Group Name/ Nombre del grupo	Group Number/ Número de grupo	Sequential Number/ Número secuencial	Preset Name/ Nombre de preajuste
	30	150	Nutracker
	31	151	Liebestraume
	32	152	Gymnopedies
	33	153	Jupiter
	34	154	Entertainer
	35	155	MapleLeafRag
TRAD			
	36	156	Michael Row
	37	157	GrndpasClock
	38	158	Troika
	39	159	AuldLangSyne
	40	160	Aloha Oe
	41	161	O Sole Mio
	42	162	Furusato
	43	163	SzlaDziweczk
	44	164	Battle Hymn
	45	165	Condor
	46	166	ScarboroFair
	47	167	Danny Boy
	48	168	Greensleeves
	49	169	Annie Laurie
	50	170	AmazingGrace
	51	171	WeWishU Xmas
	52	172	Silent Night
	53	173	Joy To World
	54	174	YankeeDoodle
	55	175	Clamt Polka
	56	176	TaRaRaBoom
	57	177	Double Eagle
	58	178	Blauen Donau
	59	179	Yellow Rose
	60	180	BeautDreamer
LATIN			
	61	181	Moon Bossa
	62	182	Your Smile
	63	183	Rio
	64	184	Bossa Blue
	65	185	One Note
	66	186	Wave Bossa
	67	187	Out Of Tune
	68	188	Quiet Star
	69	189	Insentive
	70	190	Brzl Samba
	71	191	Orpheus
	72	192	Tico-Tico
	73	193	Beguine
	74	194	Amapola
	75	195	La Paloma
	76	196	Banana Boat
	77	197	Peanut
	78	198	Coffee
	79	199	Jamaica
	80	200	MoreBeguine
	81	201	The No.5
	82	202	Everyday
	83	203	Mucho
	84	204	El Tango
	85	205	El Choclo
	86	206	Sheriff
	87	207	No Woman
	88	208	Can't Help
	89	209	Livin'
	90	210	Whenever
COUNTRY			
	91	211	This Land
	92	212	My Sunshine
	93	213	Walk Line
	94	214	Home Roads
	95	215	A Friend
	96	216	Cowboy
	97	217	Still One
	98	218	Breath
	99	219	CountryWaltz
	100	220	He Cheats
C			
BALLAD			
	1	221	Love Ballad
	2	222	R&B Ballad
	3	223	Soul Ballad
	4	224	Blues Ballad
	5	225	MovieBallad1
	6	226	MovieBallad2

Group Name/ Nombre del grupo	Group Number/ Número de grupo	Sequential Number/ Número secuencial	Preset Name/ Nombre de preajuste
	7	227	Xmas Ballad
	8	228	Love Me
	9	229	Oldies Bld 1
	10	230	Oldies Bld 2
	11	231	Oldies Bld 3
	12	232	Oldies Bld 4
	13	233	E World
	14	234	Tears
	15	235	Moon Waltz
	16	236	A's Theme
	17	237	Paradise
	18	238	60's Ballad1
	19	239	60's Ballad2
	20	240	Whiter Shade
	21	241	FrenchBallad
	22	242	Everywhere
	23	243	Wonderful
	24	244	70's Ballad1
	25	245	70's Ballad2
	26	246	My Song
	27	247	Bridge
	28	248	Img Ballad
	29	249	Without
	30	250	Not In Love
	31	251	Soft Ballad
	32	252	We Were
	33	253	Minor Ballad
	34	254	Pop Ballad 1
	35	255	Pop Ballad 2
	36	256	PianoBallad1
	37	257	PianoBallad2
	38	258	Musical Bld
	39	259	R Ballad
	40	260	Always Mind
	41	261	Endless
	42	262	80's Ballad1
	43	263	80's Ballad2
	44	264	80's Ballad3
	45	265	80's Ballad4
	46	266	Friends For
	47	267	Rock Ballad
	48	268	Eternal
	49	269	Everything
	50	270	Save Best
	51	271	Of The Road
	52	272	I Always
	53	273	New World
	54	274	Vision
	55	275	I Can Fly
	56	276	Wind Ballad
	57	277	Love To You
	58	278	My Ballad
	59	279	Beautiful
	60	280	Scrubs
	61	281	Falling
	62	282	BlngTogether
	63	283	B Day
	64	284	Rap Ballad
	65	285	Dance Ballad
	66	286	MdmRock Bld
	67	287	Slow Ballad
	68	288	Kiss Rose
JAZZ BALLAD			
	69	289	Summer
	70	290	New York
	71	291	B & S
	72	292	L Alone
	73	293	Foggy
	74	294	Moon Swing
	75	295	Foolish
	76	296	Valentine
	77	297	Midnight
	78	298	Journey
	79	299	Star
	80	300	Starlight

Fingering Guide/ Guía de digitación

Fingered 1, Fingered 2 Chords/ Acordes Fingered 1, Fingered 2

C				
Cm				
Cdim				
Caug *3				
Csus4 *3				
Csus2 *3				
C7				
Cm7 *3				
CM7				
Cm7^b5 *3				
C7^b5 *3				
C7sus4				
Cadd9				
Cmadd9				
CmM7				
Cdim7 *3				
C69 *3				
C6 *1 *3				
Cm6 *2 *3				

*1 With Fingered 2, interpreted as Am7.

*2 With Fingered 2, interpreted as Am7^b5.

*3 Inverted form not supported in some cases.

*1 Con Fingered 2, se interpreta como Am7.

*2 Con Fingered 2, se interpreta como Am7^b5.

*3 En algunos casos no se puede usar de forma invertida.

Fingered 3, Full Range Chords/ Acordes Fingered 3, Full Range

In addition to the chords that can be fingered with Fingered 1 and Fingered 2, the following chords also are recognized.

Además de los acordes que se pueden digitar con Fingered 1 y Fingered 2, también se pueden reconocer los siguientes acordes.

$\frac{C^\#}{C}$	$\frac{D}{C}$	$\frac{E}{C}$	$\frac{F}{C}$	$\frac{G}{C}$	$\frac{A^b}{C}$	$\frac{B^b}{C}$	$\frac{B}{C}$	$\frac{C^\#m}{C}$	$\frac{Dm}{C}$	$\frac{Fm}{C}$
$\frac{Gm}{C}$	$\frac{Am}{C}$	$\frac{B^bm}{C}$	$\frac{Ddim}{C}$	$\frac{A^b7}{C}$	$\frac{F7}{C}$	$\frac{Fm7}{C}$	$\frac{Gm7}{C}$	$\frac{A^badd9}{C}$		

NOTE

- With Fingered 3, the lowest note fingered is interpreted as the base note. Inverted forms are not supported.
- With Full Range Chord, when the lowest fingered is a certain distance from the neighboring note, the chord is interpreted as a fraction chord.
- Unlike Fingered 1, 2, and 3, Full Range Chord requires pressing of at least three keys to form a chord.

NOTA

- Con Fingered 3, la nota más baja digitada se interpreta como nota base. No se pueden usar formas invertidas.
- Con Full Range Chord, cuando la nota digitada más baja se encuentre a cierta distancia de la nota adyacente, el acorde se interpreta como un acorde bitonal.
- A diferencia de Fingered 1, 2, y 3, Full Range Chord requiere la pulsación de tres teclas como mínimo para formar un acorde.

Chord Example List/Lista de ejemplos de acordes

Root Chord Type	C	C♯(D♭)	D	(D♯)/E♭	E	F	F♯(G♭)	G	(G♯)/A♭	A	(A♯)/B♭	B
M												
m												
dim												
aug												
sus4												
sus2												
7												
m7												
M7												
m7♯5												
7♯5												
7sus4												
add9												
madd9												
mM7												
dim7												
69												
6												
m6												

- Since the chord input range is limited, this model may not support some of the chords shown above.
- Debido a que el rango de entrada de acordes es limitado, es posible que este modelo no admita algunos de los acordes mostrados arriba.

MIDI Implementation Chart

Function		Transmitted	Recognized	Remarks
Basic Channel	Default	1 - 16	1 - 16	
	Changed	1 - 16	1 - 16	
Mode	Default	Mode 3	Mode 3	
	Messages Altered	X *****	X *****	
Note Number	True voice	0 - 127	0 - 127	
		*****	0 - 127*1	
Velocity	Note ON	O 9nH v = 1 - 127	O 9nH v = 1 - 127	** : no relation
	Note OFF	X 8nH v = 64	X 9nH v = 0, 8nH v = **	** : sin relación
After Touch	Key's	X	X	
	Ch's	X	O	
Pitch Bender		O	O	
Control Change	0,32	O	O	Bank select
	1	X	O	Modulation
	5	X	O	Portamento Time
	6, 38	O	O	Data entry LSB, MSB*2
	7	O	O	Volume
	10	X	O	Pan
	11	X	O	Expression
	16	X	O	DSP Parameter0*2
	17	X	O	DSP Parameter1*2
	18	X	O	DSP Parameter2*2
	19	X	O	DSP Parameter3*2
	64	O	O	Damper
	65	X	O	Portamento Switch
	66	O	O	Sostenuto
	67	O	O	Soft pedal
	76	X	O	Vibrato rate
	77	X	O	Vibrato depth
	78	X	O	Vibrato delay
	80	X	O	DSP Parameter4*2
	81	X	O	DSP Parameter5*2
82	X	O	DSP Parameter6*2	
83	X	O	DSP Parameter7*2	
84	X	O	Portamento Control	
91	O	O	Reverb send	
93	O	O	Chorus send	
100, 101	O	O	RPN LSB, MSB*2	
Program Change	: True #	O *****	O 0 - 127	
System Exclusive		O	O	*2
System Common	: Song Pos	X	X	
	: Song Sel	X	X	
	: Tune	X	X	
System Real Time	: Clock	O	X	
	: Commands	O	X	
Aux Messages	: All sound off	O	O	
	: Reset all controller	O	O	
	: Local ON/OFF	X	X	
	: All notes OFF	O	O	
	: Active Sense	X	O	
	: Reset	X	X	
Remarks	*1 : Depends on tone *2 : For details, see MIDI Implementation at http://world.casio.com/ . *1 : Depende del tono *2 : Si desea más información, vea Implementación MIDI en http://world.casio.com/ .			

Mode 1 : OMNI ON, POLY
 Mode 3 : OMNI OFF, POLY

Mode 2 : OMNI ON, MONO
 Mode 4 : OMNI OFF, MONO

O : Yes
 X : No



This recycle mark indicates that the packaging conforms to the environmental protection legislation in Germany.

Esta marca de reciclaje indica que el empaquetado se ajusta a la legislación de protección ambiental en Alemania.

CASIO®