

# SONY®

## Cyber-shot

### Digital Still Camera **User's Guide/ Troubleshooting**

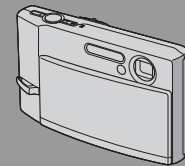

DSC-T30



#### "Read This First" (separate volume)

Explains the set-up and basic operations for shooting/playback with your camera.

#### Operating Instructions

Before operating the unit, please read this manual and "Read This First" (separate volume) thoroughly, and retain it for future reference.

#### Owner's Record

The model and serial numbers are located on the bottom. Record the serial number in the space provided below. Refer to these numbers whenever you call upon your Sony dealer regarding this product.

Model No. DSC-T30

Serial No. \_\_\_\_\_

**Enjoying the camera**

**Using the menu**

**Using the Setup screen**

**Using your computer**

**Printing still images**

**Connecting your camera to your TV**

**Troubleshooting**

**Others**

**Index**

Additional information on this product and answers to frequently asked questions can be found at our Customer Support Website.

<http://www.sony.net/>

Printed on 100% recycled paper using VOC (Volatile Organic Compound)-free vegetable oil based ink.

Printed in Japan



2 675 572 110

© 2006 Sony Corporation

2-675-572-11(1)

## WARNING

To reduce fire or shock hazard, do not expose the unit to rain or moisture.

## For Customers in the U.S.A.

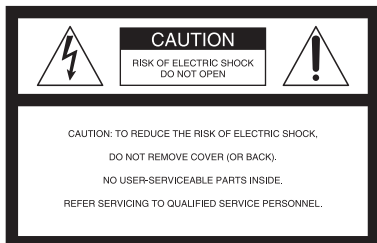

This symbol is intended to alert the user to the presence of uninsulated “dangerous voltage” within the product’s enclosure that may be of sufficient magnitude to constitute a risk of electric shock to persons.



This symbol is intended to alert the user to the presence of important operating and maintenance (servicing) instructions in the literature accompanying the appliance.

# IMPORTANT SAFEGUARDS

For your protection, please read these safety instructions completely before operating the appliance, and keep this manual for future reference.

Carefully observe all warnings, precautions and instructions on the appliance, or the one described in the operating instructions and adhere to them.

## Use

### Power Sources

This set should be operated only from the type of power source indicated on the marking label. If you are not sure of the type of electrical power supplied to your home, consult your dealer or local power company. For those sets designed to operate from battery power, or other sources, refer to the operating instructions.

### Polarization

This set may be equipped with a polarized ac power cord plug (a plug having one blade wider than the other).

This plug will fit into the power outlet only one way. This is a safety feature. If you are unable to insert the plug fully into the outlet, try reversing the plug. If the plug should still fail to fit, contact your electrician to have a suitable outlet installed. Do not defeat the safety purpose of the polarized plug by forcing it in.

### Overloading

Do not overload wall outlets, extension cords or convenience receptacles beyond their capacity, since this can result in fire or electric shock.

### Object and Liquid Entry

Never push objects of any kind into the set through openings as they may touch dangerous voltage points or short out parts that could result in a fire or electric shock. Never spill liquid of any kind on the set.

### Attachments

Do not use attachments not recommended by the manufacturer, as they may cause hazards.

## Cleaning

Unplug the set from the wall outlet before cleaning or polishing it. Do not use liquid cleaners or aerosol cleaners. Use a cloth lightly dampened with water for cleaning the exterior of the set.

## Installation

### Water and Moisture

Do not use power-line operated sets near water – for example, near a bathtub, washbowl, kitchen sink, or laundry tub, in a wet basement, or near a swimming pool, etc.

### Power-Cord Protection

Route the power cord so that it is not likely to be walked on or pinched by items placed upon or against them, paying particular attention to the plugs, receptacles, and the point where the cord exits from the appliance.

### Accessories

Do not place the set on an unstable cart, stand, tripod, bracket, or table. The set may fall, causing serious injury to a child or an adult, and serious damage to the set. Use only a cart, stand, tripod, bracket, or table recommended by the manufacturer.

### Ventilation

The slots and openings in the cabinet are provided for necessary ventilation. To ensure reliable operation of the set, and to protect it from overheating, these slots and openings must never be blocked or covered.

- Never cover the slots and openings with a cloth or other materials.
- Never block the slots and openings by placing the set on a bed, sofa, rug, or other similar surface.
- Never place the set in a confined space, such as a bookcase, or built-in cabinet, unless proper ventilation is provided.
- Do not place the set near or over a radiator or heat register, or where it is exposed to direct sunlight.

## Lightning

For added protection for this set during a lightning storm, or when it is left unattended and unused for long periods of time, unplug it from the wall outlet and disconnect the antenna or cable system. This will prevent damage to the set due to lightning and power-line surges.

## Service

### Damage Requiring Service

Unplug the set from the wall outlet and refer servicing to qualified service personnel under the following conditions:

- When the power cord or plug is damaged or frayed.
- If liquid has been spilled or objects have fallen into the set.
- If the set has been exposed to rain or water.
- If the set has been subject to excessive shock by being dropped, or the cabinet has been damaged.
- If the set does not operate normally when following the operating instructions. Adjust only those controls that are specified in the operating instructions. Improper adjustment of other controls may result in damage and will often require extensive work by a qualified technician to restore the set to normal operation.
- When the set exhibits a distinct change in performance – this indicates a need for service.

### Servicing

Do not attempt to service the set yourself as opening or removing covers may expose you to dangerous voltage or other hazards. Refer all servicing to qualified service personnel.

### Replacement parts

When replacement parts are required, be sure the service technician has used replacement parts specified by the manufacturer that have the same characteristics as the original parts. Unauthorized substitutions may result in fire, electric shock, or other hazards.

## Safety Check

Upon completion of any service or repairs to the set, ask the service technician to perform routine safety checks (as specified by the manufacturer) to determine that the set is in safe operating condition.

# Read this first

## CAUTION

Replace the battery with the specified type only. Otherwise, fire or injury may result.

## For Customers in the U.S.A. and Canada

### RECYCLING LITHIUM-ION BATTERIES

Lithium-Ion batteries are recyclable.

You can help preserve our environment by returning your used rechargeable batteries to the collection and recycling location nearest you.

For more information regarding recycling of rechargeable batteries, call toll free 1-800-822-8837, or visit <http://www.rbrcc.org/>

**Caution:** Do not handle damaged or leaking Lithium-Ion batteries.



## For Customers in the U.S.A.

If you have any questions about this product, you may call:

Sony Customer Information Services Center  
1-800-222-SONY (7669)

The number below is for the FCC related matters only.

## Regulatory Information

### Declaration of Conformity

Trade Name: SONY  
Model No.: DSC-T30  
Responsible Party: Sony Electronics Inc.  
Address: 16530 Via Esprillo,  
San Diego, CA 92127U.S.A.  
Telephone No.: 858-942-2230

This device complies with Part 15 of the FCC Rules. Operation is subject to the following two conditions: (1) This device may not cause harmful interference, and (2) this device must accept any interference received, including interference that may cause undesired operation.

## CAUTION

You are cautioned that any changes or modifications not expressly approved in this manual could void your authority to operate this equipment.

### Note:

This equipment has been tested and found to comply with the limits for a Class B digital device, pursuant to Part 15 of the FCC Rules.

These limits are designed to provide reasonable protection against harmful interference in a residential installation. This equipment generates, uses, and can radiate radio frequency energy and, if not installed and used in accordance with the instructions, may cause harmful interference to radio communications. However, there is no guarantee that interference will not occur in a particular installation. If this equipment does cause harmful interference to radio or television reception, which can be determined by turning the equipment off and on, the user is encouraged to try to correct the interference by one or more of the following measures:

- Reorient or relocate the receiving antenna.
- Increase the separation between the equipment and receiver.
- Connect the equipment into an outlet on a circuit different from that to which the receiver is connected.
- Consult the dealer or an experienced radio/TV technician for help.

The supplied interface cable must be used with the equipment in order to comply with the limits for a digital device pursuant to Subpart B of Part 15 of FCC Rules.

## For Customers in Europe

This product has been tested and found compliant with the limits set out in the EMC Directive for using connection cables shorter than 3 meters (9.8 feet).

### Attention

The electromagnetic fields at the specific frequencies may influence the picture and sound of this camera.

## Notice



If static electricity or electromagnetism causes data transfer to discontinue midway (fail), restart the application or disconnect and connect the communication cable (USB, etc.) again.

### Disposal of Old Electrical & Electronic Equipment (Applicable in the European Union and other European countries with separate collection systems)



This symbol on the product or on its packaging indicates that this product shall not be treated as household waste. Instead it shall be handed over to the applicable collection point for the recycling of electrical and electronic equipment. By ensuring this product is disposed of correctly, you will help prevent potential negative consequences for the environment and human health, which could otherwise be caused by inappropriate waste handling of this product. The recycling of materials will help to conserve natural resources. For more detailed information about recycling of this product, please contact your local Civic Office, your household waste disposal service or the shop where you purchased the product.

### Notice for customers in the United Kingdom

A moulded plug complying with BS 1363 is fitted to this equipment for your safety and convenience. Should the fuse in the plug supplied need to be replaced, a fuse of the same rating as the supplied one and approved by ASTA or BSI to BS 1362, (i.e., marked with an  or  mark) must be used.

If the plug supplied with this equipment has a detachable fuse cover, be sure to attach the fuse cover after you change the fuse. Never use the plug without the fuse cover. If you should lose the fuse cover, please contact your nearest Sony service station.

# Notes on using your camera

## Types of “Memory Stick” that can be used (not supplied)

The IC recording medium used by this camera is a “Memory Stick Duo”. There are two types of “Memory Stick”.

### “Memory Stick Duo”: you can use a “Memory Stick Duo” with your camera.



### “Memory Stick”: you cannot use a “Memory Stick” with your camera.



## Other memory cards cannot be used.

- For details on “Memory Stick Duo”, see page 104.

## When using a “Memory Stick Duo” with “Memory Stick” compatible equipment

You can use the “Memory Stick Duo” by inserting it into the Memory Stick Duo Adaptor (not supplied).



Memory Stick Duo Adaptor

## Notes on the “InfoLITHIUM” battery pack

- Charge the battery pack (supplied) before using the camera for the first time. (→ *step 1 in “Read This First”*)
- The battery pack can be charged even if it is not completely discharged. Also, even if the battery pack is not fully charged, you can use the partially charged capacity of the battery pack as is.

- If you do not intend to use the battery pack for a long time, use up the existing charge and remove it from your camera, then store it in a cool, dry place. This is to maintain the battery pack functions (page 106).
- For details on the usable battery pack, see page 106.

## Carl Zeiss lens

This camera is equipped with a Carl Zeiss lens which is capable of reproducing sharp images with excellent contrast.

The lens for this camera has been produced under a quality assurance system certified by Carl Zeiss in accordance with the quality standards of Carl Zeiss in Germany.

## No compensation for contents of the recording

The contents of the recording cannot be compensated for if recording or playback is not possible due to a malfunction of your camera or recording media, etc.

## Internal memory and “Memory Stick Duo” back up

Do not turn off the camera or remove the battery pack or “Memory Stick Duo” while the access lamp is lighted, as the internal memory data or “Memory Stick Duo” data may be destroyed. Always protect your data by making a back up copy. See page 26 for the data back up method.

## Notes on recording/playback

- This camera is neither dust-proof, nor splash-proof, nor water-proof. Read “Precautions” (page 108) before operating the camera.
- Before you record one-time events, make a trial recording to make sure that the camera is working correctly.
- Be careful not to get the camera wet. Water entering the inside of the camera may cause malfunctions which in some cases may not be repairable.
- Do not aim the camera at the sun or other bright light. It may cause the malfunction of your camera.

- Do not use the camera near a location that generates strong radio waves or emits radiation. The camera may not be able to record or play back properly.
- Using the camera in sandy or dusty locations may cause malfunctions.
- If moisture condensation occurs, remove it before using the camera (page 108).
- Do not shake or strike the camera. In addition to malfunctions and an inability to record images, this may render the recording medium unusable, or cause image data breakdown, damage or loss.
- Clean the flash surface before use. The heat of flash emission may cause dirt on the flash surface to become discolored or to stick to the flash surface, resulting in insufficient light emission.

### Notes on the LCD screen and lens

- The LCD screen is manufactured using extremely high-precision technology so over 99.99% of the pixels are operational for effective use. However, there may be some tiny black points and/or bright points (white, red, blue or green in color) that constantly appear on the LCD screen and the LCD finder. These points are normal in the manufacturing process and do not affect the recording in any way.

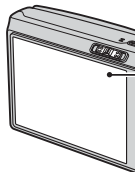

Black, white, red, blue or green points

- Exposing the LCD screen or the lens to direct sunlight for long periods may cause malfunctions. Be careful when placing the camera near a window or outdoors.
- Do not press against the LCD screen. The screen may be discolored and that may cause a malfunction.
- Images may trail across on the LCD screen in a cold location. This is not a malfunction.
- Be careful not to bump the lens, and be careful not to apply force to it.

### On image data compatibility

- This camera conforms with DCF (Design rule for Camera File system) universal standard established by JEITA (Japan Electronics and Information Technology Industries Association).
- Playback of images recorded with your camera on other equipment and playback of images recorded or edited with other equipment on your camera are not guaranteed.

### Warning on copyright

Television programs, films, videotapes, and other materials may be copyrighted. Unauthorized recording of such materials may be contrary to the provisions of the copyright laws.

### The pictures used in this manual

The photographs used as examples of pictures in this manual are reproduced images, and are not actual images shot using this camera.



# For full use of the digital still camera

## Prepare the camera and shoot images easily

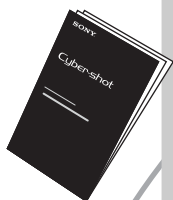

### ***“Read This First” (separate volume)***

- 1 Prepare the battery pack
- 2 Turn the camera on/set the clock
- 3 Insert a “Memory Stick Duo” (not supplied)
- 4 Select the image size for use
- 5 Shoot images easily (Auto adjustment mode)  
Shoot still images (Scene Selection)
- 6 View/delete images

## Get more friendly with your camera

*This manual*

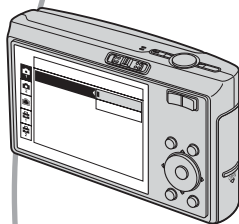

- Shoot with your favorite settings (Program auto shooting) → page 28
- Enjoy your images using the Slide Show → page 30
- Enjoy various shooting/playback using the menu → page 33
- Change the default settings → page 51

## Connect your camera to a PC or a printer

*This manual*



- Copy your images to a computer and enjoy editing them in various ways → page 63
- Print images by connecting your camera directly to a printer (PictBridge compliant printers only) → page 81

# Table of contents

|                                 |   |
|---------------------------------|---|
| Read this first.....            | 5 |
| Notes on using your camera..... | 7 |















## Enjoying the camera

|   |    |
|---|----|
| Basic techniques for better images.....   | 13 |
| Focus – Focusing on a subject successfully.....                                     | 13 |
| Exposure – Adjusting the light intensity.....                                       | 14 |
| Color – On the effects of lighting.....   | 15 |
| Quality – On “image quality” and “image size”.....                                  | 15 |
| Identifying parts.....  | 17 |
| Indicators on the screen.....   | 19 |
| Changing the screen display.....  | 23 |
| Number of still images and recording time of movies.....                            | 24 |
| When you do not have a “Memory Stick Duo” (Recording with the internal memory)..... | 25 |
| Battery life and number of images that can be recorded/viewed.....                  | 27 |
| Using the mode switch.....  | 28 |
| Using the Slide Show.....   | 30 |







## Using the menu

|                               |    |
|-------------------------------|----|
| <i>Using menu items</i> ..... | 33 |
| <i>Menu items</i> .....       | 34 |
| Shooting menu.....            | 36 |

-  (Camera)
- COLOR (Color Mode)
-  (EV)
-  (Focus)
-  (Metering Mode)
- WB (White Bal)
- ISO
-  (P.Quality)
- Mode (REC Mode)
- BRK (Bracket Step)
-  (Interval)
-  (Flash Level)
-  (Contrast)
-  (Sharpness)
-  (Setup)

|   |    |
|---|----|
| Viewing menu .....  | 45 |
|  (Folder)  |    |
|  (Protect) |    |
| DPOF  |    |
|  (Print)   |    |
|  (Slide)   |    |
|  (Resize)  |    |
|  (Rotate)  |    |
|  (Divide)  |    |
|  (Setup)   |    |
| Trimming  |    |

## Using the Setup screen

|  |    |
|--|----|
| <i>Using Setup items</i> .....   | 51 |
|  Camera 1 .....             | 52 |
| AF Mode  |    |
| Digital Zoom   |    |
| Function Guide   |    |
| Red Eye Reduction  |    |
| AF Illuminator   |    |
| Auto Review  |    |
|  Camera 2 .....             | 55 |
| STEADY SHOT  |    |
|  Internal Memory Tool ..... | 56 |
| Format   |    |
|  Memory Stick Tool .....    | 57 |
| Format   |    |
| Create REC. Folder   |    |
| Change REC. Folder   |    |
| Copy   |    |
|  Setup 1 .....            | 59 |
| Download Music   |    |
| Format Music   |    |
| LCD Backlight  |    |
| Beep   |    |
|  Language                 |    |
| Initialize   |    |
|  Setup 2 .....            | 61 |
| File Number  |    |
| USB Connect  |    |
| Video Out  |    |
| Clock Set  |    |

## Using your computer

|  |    |
|--|----|
| Enjoying your Windows computer.....  | 63 |
| Installing the software (supplied) .....   | 65 |
| Copying images to your computer .....  | 66 |
| Viewing image files stored on a computer with your camera (using a<br>“Memory Stick Duo”)..... | 72 |
| Using the “Cyber-shot Viewer” (supplied) .....   | 73 |
| Using the “Music Transfer” (supplied) .....  | 77 |
| Using your Macintosh computer .....  | 78 |

## Printing still images

|   |    |
|---|----|
| How to print still images .....                                     | 80 |
| Printing images directly using a PictBridge compliant printer ..... | 81 |
| Printing at a shop.....   | 85 |

## Connecting your camera to your TV

|                                     |    |
|-------------------------------------|----|
| Viewing images on a TV screen ..... | 87 |
|-------------------------------------|----|

## Troubleshooting

|                                      |     |
|--------------------------------------|-----|
| Troubleshooting.....                 | 89  |
| Warning indicators and messages..... | 101 |

## Others

|   |     |
|---|-----|
| On the “Memory Stick” .....             | 104 |
| On the “InfoLITHIUM” battery pack ..... | 106 |
| On the battery charger.....             | 107 |
| Precautions .....                       | 108 |
| Specifications.....                     | 110 |



|                    |     |
|--------------------|-----|
| <b>Index</b> ..... | 112 |
|--------------------|-----|

**Focus****Exposure****Color****Quality**

This section describes the basics so you can enjoy your camera. It tells you how to use various camera functions such as the mode switch (page 28), the menus (page 33), and so on.

**Focus** *Focusing on a subject successfully*

When you press the shutter button halfway down, the camera adjusts the focus automatically (Auto Focus). Remember to press the shutter button only halfway down.

Press the shutter button fully down straight away.

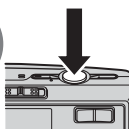

Press the shutter button halfway down.

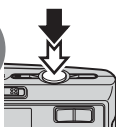

AE/AF lock indicator  
Indicator flashing →  
Indicator lit/beeps



Then press the shutter button fully down.



To shoot a still image difficult to focus on → [Focus] (page 38)

If the image looks blurred even after focusing, it may be because of camera shake. → See "Hints for preventing blur" (as follows).

**Hints for preventing blur**

Hold the camera steady, keeping your arms at your side. It is recommended to lean against a tree or a building nearby to steady yourself. Shooting with a 2-second delay self-timer, activating the anti-blur function, or using a tripod is also effective. Use the flash when you shoot under a low light condition.



## Exposure Adjusting the light intensity

You can create various images by adjusting the exposure and the ISO sensitivity. Exposure is the amount of light that the camera will receive when you release the shutter.

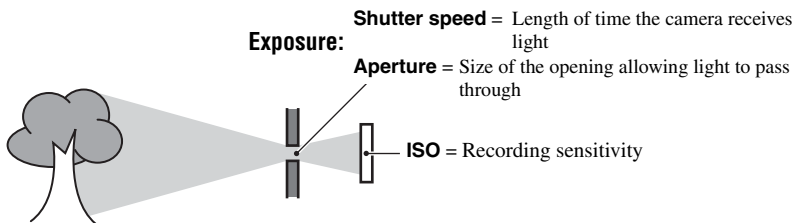

**Overexposure**  
= too much light  
Whitish image



**Correct exposure**



**Underexposure**  
= too little light  
Darker image

The exposure is automatically set to the proper value in the auto adjustment mode. However, you can adjust it manually using the functions below.

### Adjusting EV:

Allows you to adjust the exposure determined by the camera.  
→ page 37

### Metering Mode:

Allows you to change the part of the subject to be measured to determine the exposure. → page 40

## Adjusting the ISO sensitivity

ISO is unit of measurement (sensitivity), estimating how much light an image pickup device (equivalent to photo films) receives. Even when the exposure is the same, images differ depending on the ISO sensitivity.

To adjust the ISO sensitivity → page 41



### High ISO sensitivity

Records a bright image even when shooting in a dark location. However, the image tends to become noisy.



### Low ISO sensitivity





Records a smoother image.

However, when the exposure is insufficient, the image may become darker.

## Color *On the effects of lighting*

The apparent color of the subject is affected by the lighting conditions.

### Example: The color of an image affected by light sources

| Weather/lighting         | Daylight  | Cloudy  | Fluorescent   | Incandescent  |
|--------------------------|---|---|---|---|
|                          |  |  |  |  |
| Characteristics of light | White (standard)  | Bluish  | Blue-tinged   | Reddish   |

The color tones are adjusted automatically in the auto adjustment mode. However, you can adjust color tones manually with [White Bal] (page 40).

## Quality *On "image quality" and "image size"*

A digital image is made up of a collection of small dots called pixels. If it contains a large number of pixels, the picture becomes large, it takes up more memory, and the image is displayed in fine detail. "Image size" is shown by the number of pixels. Although you cannot see the differences on the screen of the camera, the fine detail and data processing time differ when the image is printed or displayed on a computer screen.

Description of the pixels and the image size

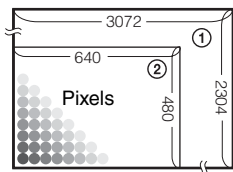

- ① Image size: 7M  
3072 pixels × 2304 pixels = 7,077,888 pixels
- ② Image size: VGA(E-Mail)  
640 pixels × 480 pixels = 307,200 pixels

## Selecting the image size for use (→ step 4 in “Read This First”)

**Many pixels** (Fine image quality and large file size) → Example: Printing in up to A3 size

**Few pixels** (Rough image quality but small file size) → Example: An attached image to be sent by e-mail

The default settings are marked with ✓.

| Image size |                                | Usage guidelines            |                                    |
|------------|--------------------------------|-----------------------------|------------------------------------|
| ✓          | 7M (3072×2304)                 | Larger<br>↑<br>↓<br>Smaller | Up to A3/11×17" print              |
|            | 3:2 <sup>1)</sup> (3072×2048)  |                             | Match 3:2 Aspect Ratio             |
|            | 5M (2592×1944)                 |                             | Up to A4/8×10" print               |
|            | 3M (2048×1536)                 |                             | Up to 13×18cm/5×7" print           |
|            | 2M (1632×1224)                 |                             | Up to 10×15cm/4×6" print           |
|            | VGA (640×480)                  |                             | For E-mail                         |
|            | 16:9 <sup>2)</sup> (1920×1080) |                             | Display On 16:9 HDTV <sup>3)</sup> |

- 1) Images are recorded in 3:2 aspect ratio, same as photograph printing paper or postcards, etc.
- 2) Both edges of the image may be cut off when printing. (page 98).
- 3) By using a Memory Stick slot or USB connection, you can enjoy images in higher quality.

|   | Movie image size        | Frame/Second | Usage guidelines             |
|---|-------------------------|--------------|------------------------------|
|   | 640(Fine) (640×480)     | Approx. 30   | Display on TV (high quality) |
| ✓ | 640(Standard) (640×480) | Approx. 17   | Display on TV (standard)     |
|   | 160 (160×112)           | Approx. 8    | For E-mail                   |

- The larger the image size, the higher the image quality.
- The more frames per second you played back, the smoother playback can be.

## Selecting the image quality (compression ratio) in combination (page 41)

You can select the compression ratio when digital images are saved. When you select a high compression ratio, the image lacks the fineness of detail, but has a smaller file size.



# Identifying parts

See the pages in parentheses for details of operation.

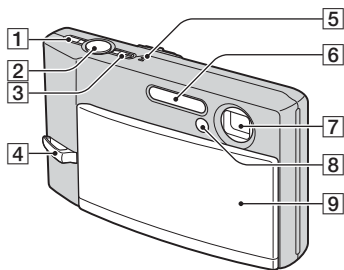

- 1 (STEADY SHOT) button (→ step 5 in “Read This First”)
- 2 Shutter button (→ step 5 in “Read This First”)
- 3 POWER button/POWER lamp (→ step 2 in “Read This First”)
- 4 Hook for wrist strap (→ “Read This First”)
- 5 Microphone
- 6 Flash (→ step 5 in “Read This First”)
- 7 Lens
- 8 Self-timer lamp (→ step 5 in “Read This First”)/AF illuminator (54)
- 9 Lens cover (→ step 2 in “Read This First”)

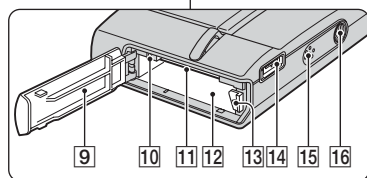
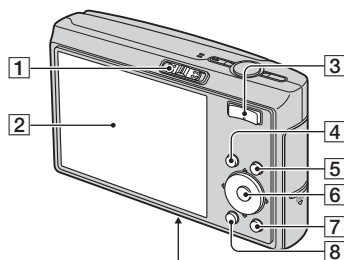

- 1 Mode switch (28)
- 2 LCD screen (23)
- 3 For shooting: Zoom (W/T) button (→ step 5 in “Read This First”)  
For viewing: / (Playback zoom) button / (Index) button (→ step 6 in “Read This First”)
- 4 MENU button (33)
- 5 (Screen display switch) button (23)
- 6 Control button  
Menu on: / (→ step 2 in “Read This First”)  
Menu off: / (→ step 5 in “Read This First”)
- 7 (Slide Show) button (30)
- 8 (Image Size/Delete) button (→ step 4 and 6 in “Read This First”)
- 9 Battery pack/“Memory Stick Duo” cover (→ step 1 and 3 in “Read This First”)
- 10 Access lamp (→ step 4 in “Read This First”)
- 11 “Memory Stick Duo” slot (→ step 3 in “Read This First”)

- 12** Battery insertion slot  
(→ step 1 in “Read This First”)
- 13** Battery eject lever  
(→ step 1 in “Read This First”)
- 14** Multi connector (bottom)  
When using an AC-LS5K AC Adaptor  
(not supplied)

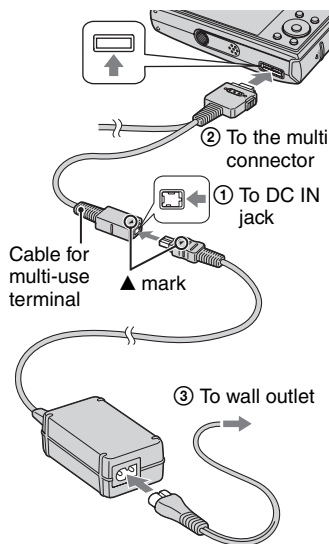

- You cannot charge the battery pack by connecting your camera to the AC-LS5K AC Adaptor. Use the battery charger to charge the battery pack.  
(→ step 1 in “Read This First”)

- 15** Speaker
- 16** Tripod receptacle (bottom)
- Use a tripod with a screw length of less than 5.5 mm (7/32 inch). You will be unable to firmly secure the camera to tripods having screws longer than 5.5 mm (7/32 inch), and may damage the camera.

# Indicators on the screen

See the pages in parentheses for details of operation.

## When shooting still images

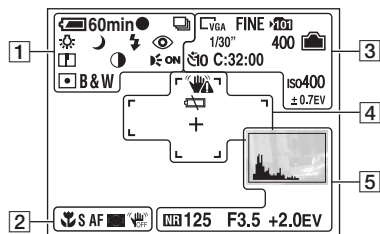

## When shooting movies

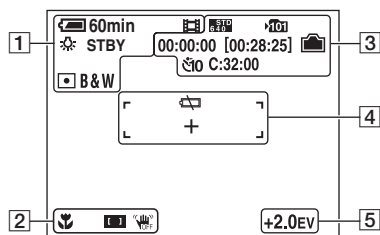

1

| Display | Indication  |
|---------|---|
|         | Battery remaining (→ step 1 in "Read This First")         |
|         | AE/AF lock (→ step 5 in "Read This First")                |
|         | Recording mode (28, 42)                                   |
|         | White balance (40)  |
|         | Standby/Recording a movie (→ step 5 in "Read This First") |

| Display | Indication  |
|---------|---|
|         | Camera mode (Scene Selection) (→ step 5 in "Read This First") |
|         | Camera mode (Program) (28)                                    |
|         | Flash mode (→ step 5 in "Read This First")                    |
|         | Flash charging  |
|         | Zoom scaling (→ 52, step 5 in "Read This First")              |
|         |   |
|         | Red-eye reduction (53)  |
|         | Sharpness (44)  |
|         | Contrast (44)   |
|         | AF illuminator (54)   |
|         | Metering mode (40)  |
|         | Color mode (36)   |
|         |   |

2

| Display | Indication   |
|---------|--|
|         | Macro/Magnifying Glass (→ step 5 in "Read This First") |
|         | AF mode (52)   |
|         | AF range finder frame indicator (38)                   |
|         | Focus preset distance (38)                             |
|         | STEADY SHOT OFF (→ step 5 in "Read This First")        |

## 3

| Display                | Indication  |
|------------------------|---|
|                        | Image size (→ <i>step 4</i> in “ <i>Read This First</i> ”)<br><ul style="list-style-type: none"> <li>1M is displayed only when the Multi Burst is activated.</li> </ul> |
| FINE STD               | Image quality (41)  |
| 101                    | Recording folder (57)<br><ul style="list-style-type: none"> <li>This does not appear when using internal memory.</li> </ul>   |
|                        | Remaining internal memory capacity (25)   |
|                        | Remaining “Memory Stick” capacity (24)  |
| 00:00:00<br>[00:28:05] | Recording time [maximum recordable time] (24)   |
| 1/30"                  | Multi Burst interval (43)   |
| 400                    | Remaining number of recordable images (24)  |
|                        | Self-timer (→ <i>step 5</i> in “ <i>Read This First</i> ”)  |
| C:32:00                | Self-diagnosis display (101)  |
| iso400                 | ISO number (41)   |
| ±0.7EV                 | Bracket Step value (43)   |

## 4

| Display | Indication   |
|---------|--|
|         | Vibration warning (13)<br><ul style="list-style-type: none"> <li>Indicates vibration may prevent you from shooting clear images due to insufficient lighting. Even if the vibration warning appears, you can still shoot images. However, we recommend that you turn on the anti-blur function, using the flash for better lighting or using a tripod or other means to stabilize the camera.</li> </ul> |
|         | Low battery warning (27, 101)  |





| Display | Indication                    |
|---------|-------------------------------|
| +       | Spot metering cross hair (40) |
|         | AF range finder frame (38)    |

## 5





| Display  | Indication  |
|--|---|
|  | Histogram (23, 37)  |
| NR   | NR slow shutter<br><ul style="list-style-type: none"> <li>When using the shutter speed set to 1/25 second or slower, the NR slow shutter function activates automatically to reduce the picture noise.</li> </ul> |
| 125  | Shutter speed   |
| F3.5   | Aperture value  |
| +2.0EV   | Exposure Value (37)   |
|  | Menu (33)   |
| (not displayed on the screen on the previous page) |   |





3

| Display   | Indication   |
|---|--|
|  | PictBridge connecting (82)   |
|  | Recording folder (57) <ul style="list-style-type: none"> <li>This does not appear when using internal memory.</li> </ul> |
|  | Playback folder (45) <ul style="list-style-type: none"> <li>This does not appear when using internal memory.</li> </ul>  |
|  | Remaining internal memory capacity (25)  |
|  | Remaining "Memory Stick" capacity (24)   |
| 8/8 12/12   | Image number/Number of images recorded in selected folder  |
| C:32:00   | Self-diagnosis display (101)   |
| 00:00:12  | Counter (→ <i>step 6</i> in "Read This First")   |

4

| Display   | Indication   |
|---|--|
|    | PictBridge connecting (83) <ul style="list-style-type: none"> <li>Do not disconnect the cable for multi-use terminal while the icon is displayed.</li> </ul> |
| +2.0EV  | Exposure Value (37)  |
| iso400  | ISO number (41)  |
|   | Metering mode (40)   |
|  | Flash  |
|  | White balance (40)   |
| 500   | Shutter speed  |
| F3.5  | Aperture value   |
|  | Playback image (→ <i>step 6</i> in "Read This First")  |

5

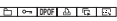
| Display   | Indication   |
|---|--|
|  | Histogram (23, 37) <ul style="list-style-type: none"> <li> appears when histogram display is disabled.</li> </ul> |
| 2006 1 1<br>9:30 AM   | Recorded date/time of the playback image   |
|  | Menu (33)  |
| ● PAUSE<br>● PLAY   | Playing back Multi Burst images in series (42)   |
| ◀▶ BACK/<br>NEXT  | Select images  |
| ⬇ VOLUME  | Adjust volume  |

# Changing the screen display

Each time you press the  (Screen display switch) button, the display changes as follows.

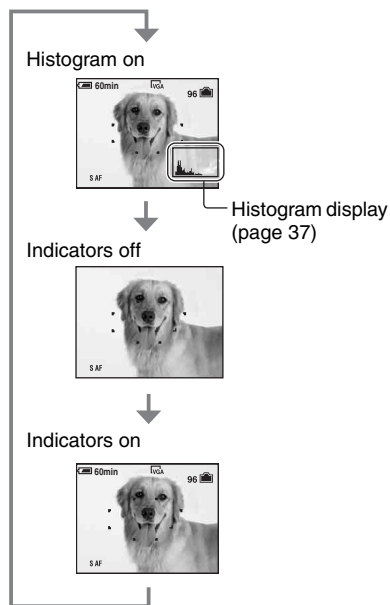

- By pressing  (Screen display switch) button longer, you can increase the LCD backlight.
- When you set the histogram display to on, image information is displayed during playback.
- The histogram does not appear in the following situations:
  - While shooting
    - When the menu is displayed.
    - When recording movies
  - During playback
    - When the menu is displayed.
    - In index mode
    - When you are using playback zoom.
    - When you are rotating still images.
    - During playback of movies
- A large difference in the histogram displayed when shooting and during playback may occur when:
  - The flash strobes.
  - The shutter speed is slow or high.
- The histogram may not appear for images recorded using other cameras.

# Number of still images and recording time of movies

The tables show the approximate number of still images and the length of time for movies that can be recorded on a "Memory Stick Duo" formatted with this camera. The values may vary depending on the shooting conditions.

For image size and quality, see page 15 in this manual and *step 4* in "Read This First".

**The number of still images (The image quality is [Fine] on the upper line and [Standard] on the lower line.)**

(Units: Images)

| Size \ Capacity | 32MB | 64MB | 128MB | 256MB | 512MB | 1GB   | 2GB   |
|-----------------|------|------|-------|-------|-------|-------|-------|
| 7M              | 9    | 18   | 37    | 67    | 137   | 279   | 573   |
|                 | 18   | 36   | 73    | 132   | 268   | 548   | 1125  |
| 3:2             | 9    | 18   | 37    | 67    | 137   | 279   | 573   |
|                 | 18   | 36   | 73    | 132   | 268   | 548   | 1125  |
| 5M              | 12   | 25   | 51    | 92    | 188   | 384   | 789   |
|                 | 23   | 48   | 96    | 174   | 354   | 723   | 1482  |
| 3M              | 20   | 41   | 82    | 148   | 302   | 617   | 1266  |
|                 | 37   | 74   | 149   | 264   | 537   | 1097  | 2250  |
| 2M              | 33   | 66   | 133   | 238   | 484   | 988   | 2025  |
|                 | 61   | 123  | 246   | 446   | 907   | 1852  | 3798  |
| VGA             | 196  | 394  | 790   | 1428  | 2904  | 5928  | 12154 |
|                 | 491  | 985  | 1975  | 3571  | 7261  | 14821 | 30385 |
| 16:9            | 33   | 66   | 133   | 238   | 484   | 988   | 2025  |
|                 | 61   | 123  | 246   | 446   | 907   | 1852  | 3798  |

- The number of images listed is for when [Mode] is set to [Normal].
- When the number of remaining shootable images is greater than 9,999, the ">9999" indicator appears.
- You can resize the images later ([Resize], page 47).

**The recording time of movies**

(Units: hour : minute : second)

| Size \ Capacity | 32MB    | 64MB    | 128MB   | 256MB   | 512MB   | 1GB      | 2GB      |
|-----------------|---------|---------|---------|---------|---------|----------|----------|
| 640(Fine)       | –       | –       | –       | 0:02:50 | 0:06:00 | 0:12:20  | 0:25:10  |
| 640(Standard)   | 0:01:20 | 0:02:50 | 0:05:50 | 0:10:40 | 0:21:40 | 0:44:20  | 1:31:00  |
| 160             | 0:22:40 | 0:45:30 | 1:31:30 | 2:51:20 | 5:47:00 | 11:44:20 | 24:18:20 |

- Movies with the size set to [640(Fine)] can only be recorded on a "Memory Stick PRO Duo".
- When images recorded using earlier Sony models are played back on this camera, the display may differ from the actual image size.



# When you do not have a “Memory Stick Duo” (Recording with the internal memory)

The camera has 58 MB of internal memory. This memory is not removable. Even when there is no “Memory Stick Duo” inserted in the camera, you can record images using this internal memory.

- Movies with the image size set to [640(Fine)] cannot be recorded using the internal memory.

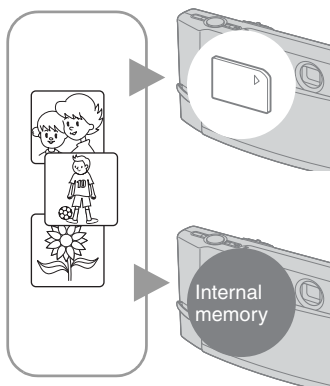

## When a “Memory Stick Duo” is inserted

[Recording]: Images are recorded on the “Memory Stick Duo”.

[Playback]: Images on the “Memory Stick Duo” are played back.

[Menu, Setup, etc.]: Various functions can be performed on images on the “Memory Stick Duo”.

## When there is no “Memory Stick Duo” inserted

[Recording]: Images are recorded using the internal memory.

[Playback]: Images stored in the internal memory are played back.

[Menu, Setup, etc.]: Various functions can be performed on images in the internal memory.

Recordable number of still images and time of movies in the Internal Memory are as follows.

## The number of still images (The image quality is [Fine] on the upper line and [Standard] on the lower line.)

(Units: Images)

| Capacity \ Size | 7M | 3:2 | 5M | 3M | 2M  | VGA | 16:9 |
|-----------------|----|-----|----|----|-----|-----|------|
| 58MB            | 16 | 16  | 23 | 37 | 60  | 357 | 60   |
|                 | 33 | 33  | 43 | 67 | 111 | 892 | 111  |

## The recording time of movies

(Units: hour : minute : second)

| Capacity \ Size | 640 (Standard) | 160     |
|-----------------|----------------|---------|
| 58MB            | 0:02:30        | 0:42:40 |

## **On image data stored in the internal memory**

We recommend that you copy (back up) data without error using one of the following methods.

### **To copy (back up) data on a “Memory Stick Duo”**

Prepare a “Memory Stick Duo” with a capacity of 64 MB or more, then perform the procedure explained in [Copy] (page 58).

### **To copy (back up) data on a hard disk of your computer**

Perform the procedure on pages 66 to 70 without a “Memory Stick Duo” inserted in the camera.

- You cannot copy image data on a “Memory Stick Duo” to the internal memory.
- By connecting the camera and a computer with a cable for multi-use terminal, you can copy data stored in the internal memory to a computer. However you cannot copy data on a computer to the internal memory.

# Battery life and number of images that can be recorded/viewed

The tables show the approximate number of images that can be recorded/viewed and the battery life when you shoot images in [Normal] mode with the battery pack (supplied) at full capacity and at an ambient temperature of 25°C (77°F). The numbers of images that can be recorded or viewed take into account changing the “Memory Stick Duo” as necessary. Note that the actual numbers may be less than those indicated in the table depending on the conditions of use.

- Battery capacity decreases as you use it more, as the time passes (page 106).
- The number of images that can be recorded/viewed and the battery life are decreased under the following conditions:
  - The surrounding temperature is low.
  - The flash is used frequently.
  - The camera has been turned on and off many times.
  - The zoom is used frequently.
  - The brightness of LCD Backlight is set to up.
  - [AF Mode] is set to [Monitor].
  - [STEADY SHOT] is set to [Continuous].
  - The battery power is low.

## When shooting still images

| No. of images | Battery life (min.) |
|---------------|---------------------|
| Approx. 420   | Approx. 210         |

- Shooting in the following situations:
  -  (PQuality) is set to [Fine].
  - [AF Mode] is set to [Single].
  - [STEADY SHOT] is set to [Shooting].
  - Shooting once every 30 seconds.
  - The zoom is switched alternately between the W and T ends.
  - The flash strobes once every two times.
  - The power turns on and off once every ten times.
- The measurement method is based on the CIPA standard.  
(CIPA: Camera & Imaging Products Association)
- The number of images/battery life does not change, regardless of image size.

## When viewing still images

| No. of images | Battery life (min.) |
|---------------|---------------------|
| Approx. 8000  | Approx. 400         |

- Viewing single images in order at about three second intervals

## When shooting movies

| Battery life (min.) |
|---------------------|
| Approx. 200         |

- Shooting movies continuously with an image size of [160]

# Using the mode switch

Set the mode switch to the desired function.

## Still image shooting modes

### Auto: Auto adjustment mode

Allows easy shooting with the settings adjusted automatically. → *step 5 in "Read This First"*

### Program: Program auto shooting mode

Allows you to shoot with the exposure adjusted automatically (both the shutter speed and the aperture value). Also you can select various settings using the menu.  
(For details on the available functions → page 34)

### ISO : Scene Selection mode

Allows you to shoot with the preset settings according to the scene. → *step 5 in "Read This First"*

- To change the shooting mode → page 33

## Playback/Edit

→ *step 6 in "Read This First"*

## Shooting movies

→ *step 5 in "Read This First"*

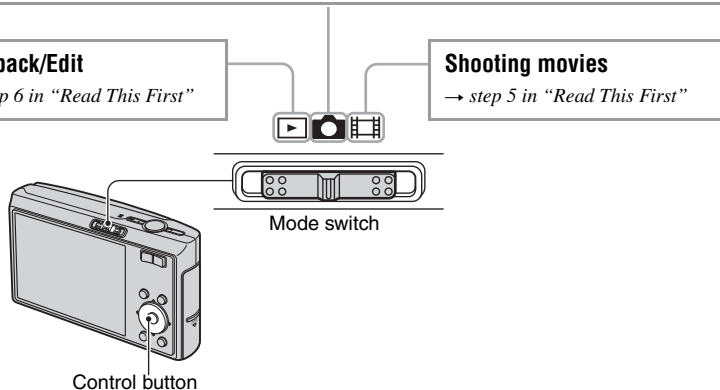

After page 36, the available mode position for the menu items is shown as follows.

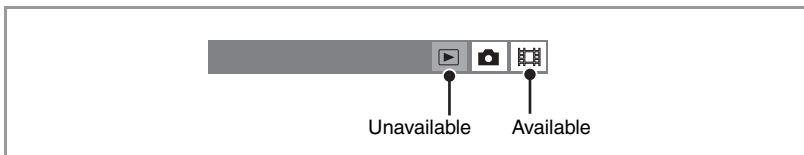























## Scene Selection

For details → *step 5* in “*Read This First*”

For shooting an image appropriately according to the scene condition, a combination of functions is determined by the camera.

(✓: you can select the desired setting)

|  | Macro/<br>Magnifying<br>Glass | Flash   | AF range<br>finder | Focus<br>preset | White<br>Balance  | Flash level | Burst/<br>Exposure Bracket/<br>Multi Burst |
|--|-------------------------------|---|--------------------|-----------------|---|-------------|--|
|  | ✓/—                           |    | ✓                  | ✓               | ✓   | —           | ✓  |
|  | —/—                           |    | ✓                  | ∞               | ✓   | —           | —  |
|  | ✓/—                           |  SL  | ✓                  | ✓               | Auto/  | ✓           | —  |
|  | ✓/—                           | ✓   | ✓                  | ✓               | ✓   | ✓           | ✓  |
|  | —/—                           |  /  | ✓                  | ∞               | ✓   | ✓           | ✓  |
|  | ✓/—                           |  /  | ✓                  | ✓               | ✓   | ✓           | ✓  |
|  | ✓/—                           |  /  | ✓                  | ✓               | ✓   | ✓           | ✓  |
|  | ✓/—                           |  /  | ✓                  | ✓               | ✓   | ✓           | ✓  |
|  | —/—                           |    | —                  | ∞               |        | —           | —  |

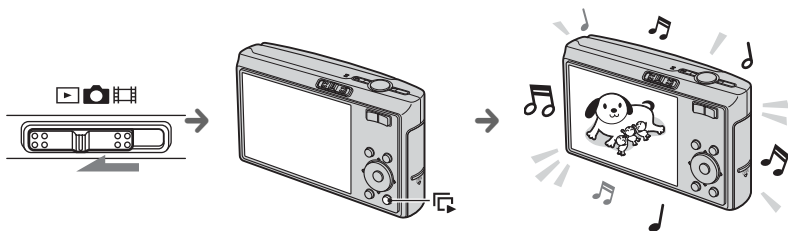

# Using the Slide Show

By simply pressing  button, you can enjoy continuous image playback accompanied by effects and music (Slide Show).





- ① Set the mode switch to .
- ② Press .
- ③ Slide show starts.

## To adjust the volume of the music

Press / to adjust the volume.

## To pause the slide show



Press  on the control button.

To restart, select [Continue], then press .



- The slide show resumes from the image which was paused, however, the music starts again from the beginning.



## To display the previous/next image

Press / during pause.

## To end the slide show





Press either  or select [Exit] with  during pause, then press .

- You cannot play back a slide show while using PictBridge connecting.

## To change the setting



You can select the desired setting for the slide show. Also, you can start the slide show again.

- ① Press the MENU button to display the menu.

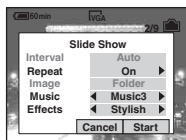
- ② Select  (Slide) with /  on the control button, then press .



- ③ Select the item you want to set with / , then select the desired item with / .

- ④ Select [Start] with / , then press .

The slide show starts.

If you do not want to start the slide show immediately, press [Cancel].

- The selected setting remains until the next setting is assigned.

The following settings are available.

The default settings are marked with .

## Effects

|   |           |  |
|---|-----------|--|
|   | Simple    | A simple slide show suitable for a wide range of scenes.         |
|   | Nostalgic | A moody slide show reproducing the atmosphere of a movie scene.  |
|  | Stylish   | A stylish slide show proceeding at a middle tempo.               |
|   | Active    | A high-tempo slide show suitable for active scenes.              |
|   | Normal    | A basic slide show switching images at a predetermined interval. |

- When set to [Simple], [Nostalgic], [Stylish] or [Active]:
  - Only still images are displayed.
  - When images are shot by Multi Burst, the first frame of continuous images is displayed.
- Music is not played (set to [Off]) during a [Normal] slide show. The sound of movies will be heard.

## Music

The preset-Music differs depending on the effect you select.

|   |         |  |
|---|---------|--|
|   | Music 1 | The default setting for a [Simple] slide show.         |
|   | Music 2 | The default setting for a [Nostalgic] slide show.      |
|  | Music 3 | The default setting for a [Stylish] slide show.        |
|   | Music 4 | The default setting for a [Active] slide show.         |
|   | Off     | Setting for a [Normal] slide show. No Music available. |

## Image

|                                     |        |   |
|-------------------------------------|--------|---|
| <input checked="" type="checkbox"/> | Folder | Plays back all the images in the selected folder.           |
| <input type="checkbox"/>            | All    | Plays back all the images in a "Memory Stick Duo" in order. |

## Repeat

|                                     |     |  |
|-------------------------------------|-----|--|
| <input checked="" type="checkbox"/> | On  | Plays back images in a continuous loop.                          |
| <input type="checkbox"/>            | Off | After all the images have been played back, the slide show ends. |

## Interval

|                                     |        |  |
|-------------------------------------|--------|--|
| <input checked="" type="checkbox"/> | 3 sec  | Sets the display interval of images for a [Normal] slide show. |
| <input type="checkbox"/>            | 5 sec  |  |
| <input type="checkbox"/>            | 10 sec |  |
| <input type="checkbox"/>            | 30 sec |  |
| <input type="checkbox"/>            | 1 min  |  |

|                                     |        |                         |
|-------------------------------------|--------|-------------------------|
| <input type="checkbox"/>            | Start  | Starts the slide show.  |
| <input checked="" type="checkbox"/> | Cancel | Cancels the slide show. |

### To add/change Music files

You can transfer a desired music file from your CDs or MP3 files to the camera to play back during Slide show. You can transfer the music by [Download Music] in  (Setup) using the software "Music Transfer" (supplied) installed on a computer. For details, see pages 77 and 79.

- You can record up to four pieces of music on the camera (The four preset pieces (Music 1-4) can be replaced with the ones you transferred).
- A maximum length of each music file for music playback of the camera is 180 seconds.
- If you cannot play back a Music file due to damage or other malfunctions to the file, execute [Format Music] (page 59) and transfer the music again.





# Using menu items

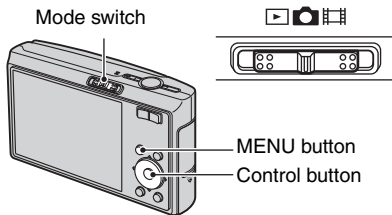
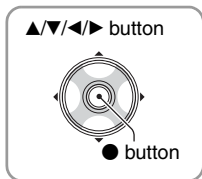

## 1 Turn on the power and set the mode switch.

Different items are available depending on the position of the mode switch and the (Camera) menu settings.

## 2 Press MENU to display the menu.

## 3 Select the desired menu item with ◀/▶ on the control button.

- If the desired item is invisible, keep pressing ◀/▶ until the item appears on the screen.
- Press ● after selecting an item when the mode switch is set to .

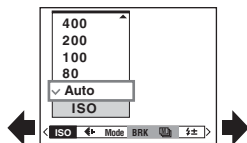

## 4 Select a setting with ▲/▼.

The setting you select is zoomed and set.

## 5 Press MENU to hide the menu.

### To change the current mode to the shooting mode



You can also hide the menu by pressing the shutter button halfway down.

- If there is an item that is not displayed, an ▲/▼ mark appears on the edges of the location where menu items usually appear. To display an item that is not displayed, select the mark with the control button.
- You cannot set items that are not available to select.

The available menu items vary depending on the mode switch position. Only the available items are displayed on the screen.

(✓ : available)





Mode switch position:

|   |         |       |   |   |
|---|---------|-------|---|---|
|  |         |       |  |  |
| Auto  | Program | Scene |   |   |

## Menu for shooting (page 36)

|   |   |   |    |   |   |
|---|---|---|----|---|---|
|  (Camera)        | ✓ | ✓ | ✓  | — | — |
| COLOR (Color Mode)  | — | ✓ | —  | ✓ | — |
|  (EV)            | — | ✓ | ✓  | ✓ | — |
|  (Focus)         | — | ✓ | ✓  | ✓ | — |
|  (Metering Mode) | — | ✓ | ✓  | ✓ | — |
| WB (White Bal)  | — | ✓ | ✓  | ✓ | — |
| ISO   | — | ✓ | ✓  | — | — |
|  (P.Quality)     | — | ✓ | ✓  | — | — |
| Mode (REC Mode)   | ✓ | ✓ | ✓  | — | — |
| BRK (Bracket Step)  | — | ✓ | ✓* | — | — |
|  (Interval)      | — | ✓ | ✓* | — | — |
|  (Flash Level)   | — | ✓ | ✓* | — | — |
|  (Contrast)      | — | ✓ | —  | — | — |
|  (Sharpness)     | — | ✓ | —  | — | — |
|  (Setup)         | ✓ | ✓ | ✓  | ✓ | — |

**Menu for viewing** (page 45)

|   |   |   |   |   |   |
|---|---|---|---|---|---|
|  (Folder)  | — | — | — | — | ✓ |
|  (Protect) | — | — | — | — | ✓ |
| DPOF  | — | — | — | — | ✓ |
|  (Print)   | — | — | — | — | ✓ |
|  (Slide)   | — | — | — | — | ✓ |
|  (Resize)  | — | — | — | — | ✓ |
|  (Rotate)  | — | — | — | — | ✓ |
|  (Divide)  | — | — | — | — | ✓ |
|  (Setup)   | — | — | — | — | ✓ |
| Trimming**  | — | — | — | — | ✓ |

\* The operation is limited according to the Scene mode (page 29).

\*\* Available only for playback zoom.

The default settings are marked with .



Select the still image camera mode. → *step 5 in "Read This First"*



You can change the brightness of the image, accompanied by effects.

|  |                   |   |
|--|-------------------|---|
|  | B&W (B & W)       | Sets the image to monochromatic color   |
|  | Sepia (SEPIA)     | Sets the image to sepia color           |
|  | Natural (NATURAL) | Sets the image to quiet color           |
|  | Vivid (VIVID)     | Sets the image to bright and deep color |
|  | Normal            |   |

- You can select only [B&W] and [Sepia] when shooting movies.
- When [Multi Burst] is selected, the color mode is set to [Normal].

 (EV)

Toward -

Toward +



Manually adjusts the exposure.

|   |          |   |
|---|----------|---|
|   | ↑ +2.0EV | Toward +: Brightens an image.                           |
| ✓ | 0EV      | The exposure is automatically determined by the camera. |
|   | ↓ -2.0EV | Toward -: Darkens an image.                             |

- For details on the exposure → page 14
- The compensation value can be set in 1/3EV increments.
- If a subject is being shot in extremely bright or dark conditions, or the flash is used, the exposure adjustment may not be effective.

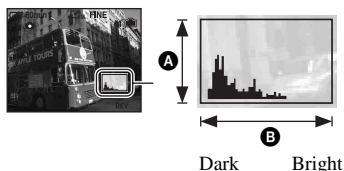
#### Adjusting EV (Exposure Value) by displaying a histogram









A histogram is a graph showing the brightness of an image. Press  (Screen display switch) repeatedly to display the histogram inside the screen. The graph display indicates a bright image when skewed to the right side, and a dark image when skewed to the left side. Set the mode switch to  and adjust EV while checking the exposure with the histogram.

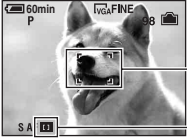

- A** Number of pixels
- B** Brightness

- The histogram also appears in the following cases, but you cannot adjust the exposure.
  - When  (Camera) is set to [Auto]
  - When playing back a single still image
  - During Quick Review

 (Focus)

You can change the focus method. Use the menu when it is difficult to get the proper focus in auto focus mode.

|  |  |
|--|--|
| <p><math>\infty</math> (unlimited distance)</p> <p>7.0m</p> <p>3.0m</p> <p>1.0m</p> <p>0.5m</p>  | <p>Focuses on the subject using a previously set distance to the subject. (Focus preset)</p> <ul style="list-style-type: none"> <li>When shooting a subject through a net or through window glass, it is difficult to get the proper focus in auto focus mode. In these cases, use of [Focus] is convenient.</li> </ul>  |
| <p>Spot AF ()</p>   | <p>Focuses on an extremely small subject or a narrow area automatically.</p> <ul style="list-style-type: none"> <li>Using together with the AF lock function lets you shoot in the desired image composition. Hold the camera steady not to misalign the subject and the AF range finder frame.</li> </ul>  <p>AF range finder frame</p> <p>AF range finder frame indicator</p> |
| <p>Center AF ()</p>   | <p>Focuses on a subject in the center of the finder frame automatically.</p> <ul style="list-style-type: none"> <li>Using this with the AF lock function lets you shoot in the desired image composition.</li> </ul>  <p>AF range finder frame</p> <p>AF range finder frame indicator</p>  |
| <p> Multi AF (Multipoint AF)<br/>(Still image )<br/>(Movie )</p> | <p>Focuses on a subject in all ranges of the finder frame automatically.</p> <ul style="list-style-type: none"> <li>This mode is useful when the subject is not in the center of the frame.</li> </ul>  <p>AF range finder frame</p> <p>AF range finder frame indicator</p>   |

- AF stands for Auto Focus.
- Distance setting information in [Focus] is approximate. If you point the lens up or down, the error increases.
- When you are shooting movies, [Multi AF] is recommended as the AF works even with a certain amount of vibration.
- When you use Digital Zoom or AF Illuminator, priority AF movement is given to subjects in or near the center of the frame. In this case the ,  or  indicator flashes and the AF range finder frame is not displayed.
- Some options are not available depending on the Scene mode (page 29).

### If the subject is out of focus

When shooting with the subject at the edge of the frame (or the screen), or when using [Center AF] or [Spot AF], the camera may not focus on a subject at the edge of the frame. In such cases, do as follows.

- ① Recompose the shot so that the subject is centered in the AF range finder, and press the shutter button halfway down to focus on the subject (AF lock).

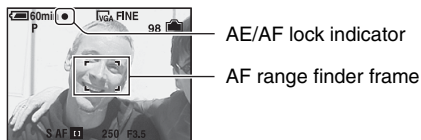



As long as you do not press the shutter button fully down, you can retry the procedure as many times as you want.

- ② When the AE/AF lock indicator stops flashing and remains on, return to the fully composed shot, and press the shutter button fully down.

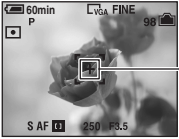

 (Metering Mode)

Selects the metering mode that sets which part of the subject to measure to determine the exposure.





|   |   |   |
|---|---|---|
|   | <b>Spot (Spot metering)</b><br>              | Measures only a part of the subject. <ul style="list-style-type: none"> <li>This function is useful when the subject is backlit or when there is strong contrast between the subject and the background.</li> </ul>  Spot metering cross hairs<br>Positions on the subject |
|   | <b>Center (Center-weighted metering)</b><br> | Measures the center of the image, and determines the exposure based on the brightness of the subject there.   |
| ✓ | <b>Multi (Multi-pattern metering)</b>   | Divides into multiple regions and measures each region. The camera determines a well-balanced exposure.   |



- For details on the exposure → page 14
- When using spot metering or center-weighted metering, setting [] (Focus) to [Center AF] is recommended to focus on the metering position (page 38).

## WB (White Bal)



Adjusts the color tones according to the lighting condition in a situation, for example, when the colors of an image look strange.

|   |  |   |
|---|--|---|
|   | <b>Flash ()</b>         | Adjusts for the flash conditions. <ul style="list-style-type: none"> <li>You cannot select this item when shooting movies.</li> </ul>             |
|   | <b>Incandescent ()</b>  | Adjusts for places where the lighting conditions change quickly such as at a party hall, or under bright lighting such as at photography studios. |
|   | <b>Fluorescent ()</b> | Adjusts for fluorescent lighting.   |
|   | <b>Cloudy ()</b>      | Adjusts for a cloudy sky.   |
|   | <b>Daylight ()</b>    | Adjusts for outdoors, shooting night scenes, neon signs, fireworks, or sunrise, or conditions before and after sundown.                           |
| ✓ | <b>Auto</b>  | Adjusts the White Balance automatically.  |

- For details on the white balance → page 15
- Under fluorescent lights that flicker, the white balance function may not work correctly even though you select [Fluorescent] ()
- Except in [Flash] () modes, [WB] is set to [Auto] when the flash strobes.
- Some options are not available depending on the Scene mode (page 29).



## ISO



Selects a luminous sensitivity with units of ISO. The larger the number, the higher the sensitivity.

|                                     |      |  |
|-------------------------------------|------|--|
| <input type="checkbox"/>            | 1000 | Select a large number when shooting in dark locations or shooting a subject moving at high speed, or select a small number to obtain high image quality. |
| <input type="checkbox"/>            | 800  |  |
| <input type="checkbox"/>            | 400  |  |
| <input type="checkbox"/>            | 200  |  |
| <input type="checkbox"/>            | 100  |  |
| <input type="checkbox"/>            | 80   |  |
| <input checked="" type="checkbox"/> | Auto |  |

- For details on the ISO sensitivity → page 14
- Note that the image tends to become noisier as the ISO sensitivity number increases.
- [ISO] is set to [Auto] in the Scene mode.
- When shooting under brighter conditions, the camera automatically increases its tone reproduction and helps prevent images to become whitish (excluding when [ISO] is set to [80] or [100]).

 (P. Quality)

Selects the still image quality.



|                                     |                |   |
|-------------------------------------|----------------|---|
| <input checked="" type="checkbox"/> | Fine (FINE)    | Records with high quality (low compression).      |
| <input type="checkbox"/>            | Standard (STD) | Records with standard quality (high compression). |

- For details on the image quality → page 15





## Mode (REC Mode)



Selects whether the camera performs continuous shooting or not when you press the shutter button.

|                                     |   |   |
|-------------------------------------|---|---|
| <input type="checkbox"/>            | Multi Burst  | Records 16 frames in succession as a still image file when you press the shutter button. <ul style="list-style-type: none"> <li>• This is convenient for checking your form in sports, for example.</li> <li>• You can select the Multi Burst shutter interval in [Interval] mode (page 43).</li> </ul> |
| <input type="checkbox"/>            | Exp Brktg (BRK)   | Records a series of three images with the exposure values automatically shifted. <ul style="list-style-type: none"> <li>• When you cannot decide the correct exposure, shoot in the Exp Brktg mode, shifting the exposure value. You can select the image with the best exposure afterward.</li> </ul>  |
| <input type="checkbox"/>            | Burst        | Records the maximum number of images in succession (refer to the following table) when you press and hold down the shutter button. <ul style="list-style-type: none"> <li>• When “Recording” disappears, you can shoot the next image.</li> </ul>   |
| <input checked="" type="checkbox"/> | Normal  | Does not shoot continuously.  |

## On the [Multi Burst]

- You can successively play back images shot in the Multi Burst mode using the following procedures:
  - To pause/resume: Press  on the control button.
  - To play back frame-by-frame: Press  in pause mode. Press  to resume playback in series.
- You cannot use the following functions in the Multi Burst mode:
  - Smart zoom
  - Flash
  - Dividing a series of images shot in the Multi Burst mode
  - Extracting or deleting a frame in a series of images shot in the Multi Burst mode
  - Setting the frame interval to a mode other than [1/30] when  (Camera) is set to [Auto]
- When playing back a series of images shot in the Multi Burst mode using a computer or a camera not equipped with the Multi Burst function, the image is displayed as a single image with 16 frames.
- The image size of images shot in the Multi Burst mode is 1M.
- You may not be able to shoot images in the Multi Burst mode depending on the Scene mode (page 29).

## On the [Exp Brktg]

- The flash is set to  (Flash forced off).
- The focus and white balance are adjusted for the first image, and these settings are also used for the other images.
- When the exposure is manually adjusted (page 37), the exposure is shifted based on the adjusted brightness.
- The recording interval is approximately 1 second.
- If the subject is too bright or too dark, you may be unable to shoot properly with the selected bracket step value.
- You may not be able to shoot images in the Exposure Bracket mode depending on the Scene mode (page 29).

On the [Burst]

- The flash is set to  (Flash forced off).
- When recording with the self timer, a series of a maximum of five images is recorded.
- The recording interval is approximately 0.92 second.
- When the battery level is low, or when the internal memory or “Memory Stick Duo” is full, the Burst stops.
- You may not be able to shoot images in the Burst mode depending on the Scene mode (page 29).

The maximum number of continuous shots

(Units: images)

| Size \ Quality | Fine | Standard |
|----------------|------|----------|
| 7M             | 5    | 8        |
| 3:2            | 5    | 8        |
| 5M             | 6    | 11       |
| 3M             | 9    | 17       |
| 2M             | 15   | 27       |
| VGA            | 85   | 100      |
| 16:9           | 15   | 27       |

### BRK (Bracket Step)

Records a series of three images with the exposure values automatically shifted.

|                                     |        |   |
|-------------------------------------|--------|---|
| <input type="checkbox"/>            | ±1.0EV | Shifts the exposure value by plus or minus 1.0EV. |
| <input checked="" type="checkbox"/> | ±0.7EV | Shifts the exposure value by plus or minus 0.7EV. |
| <input type="checkbox"/>            | ±0.3EV | Shifts the exposure value by plus or minus 0.3EV. |

- BRK (Bracket Step) is not displayed in some Scene modes.

### (Interval)

Selects the frame interval in the [Multi Burst] mode (page 42).

|                                     |                |   |
|-------------------------------------|----------------|---|
| <input type="checkbox"/>            | 1/7.5 (1/7.5") | <ul style="list-style-type: none"> <li>• Select [Multi Burst] in [Mode] first, then set the desired frame interval in [Interval]. When you select a function other than [Multi Burst], this function is unavailable.</li> </ul> |
| <input type="checkbox"/>            | 1/15 (1/15")   |   |
| <input checked="" type="checkbox"/> | 1/30 (1/30")   |   |

-  (Interval) is not displayed in some Scene modes.

 (Flash Level)

Adjusts the amount of flash light.

|   |        |   |
|---|--------|---|
|   | + (⚡+) | Toward +: Makes the flash level higher. |
| ✓ | Normal |   |
|   | - (⚡-) | Toward -: Makes the flash level lower.  |

- To change flash mode → *step 5 in “Read This First”*
- You may not be able to set the Flash Level depending on the Scene mode (page 29).

 (Contrast)

Adjusts the contrast of the image.

|   |        |                                  |
|---|--------|----------------------------------|
|   | + (☉)  | Toward +: Enhances the contrast. |
| ✓ | Normal |                                  |
|   | - (☉)  | Toward -: Reduces the contrast.  |

 (Sharpness)

Adjusts the sharpness of the image.

|   |        |                               |
|---|--------|-------------------------------|
|   | + (⌘)  | Toward +: Sharpens the image. |
| ✓ | Normal |                               |
|   | - (⌘)  | Toward -: Softens the image.  |

 (Setup)

See page 51.

The default settings are marked with ✓.



Selects the folder containing the image you want to play back when using the camera with "Memory Stick Duo".

|   |        |                              |
|---|--------|------------------------------|
|   | OK     | See the following procedure. |
| ✓ | Cancel | Cancels the selection.       |

- ① Select the desired folder with ◀/▶ on the control button.

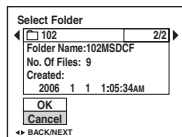

- ② Select [OK] with ▲, then press ●.

### On the folder

The camera stores images in a specified folder of a "Memory Stick Duo" (page 57). You can change the folder or create a new one.

- To create a new folder → [Create REC. Folder] (page 57)
- To change the folder for recording images → [Change REC. Folder] (page 58)
- When multiple folders are created in the "Memory Stick Duo" and the first or last image in the folder is displayed, the following indicators appear.

: Moves to the previous folder.

: Moves to the next folder.



: Moves to either the previous or next folders.

**Protect**



Protects images against accidental erasure.

|   |                   |                                |
|---|-------------------|--------------------------------|
| ✓ | Protect (Protect) | See the following procedure.   |
|   | Exit              | Exits the Protection function. |











### To protect images in single-image mode

- ① Display the image you want to protect.
- ② Press MENU to display the menu.
- ③ Select [Protect] with  on the control button, then press .  
The image is protected and the  (protect) indicator appears on the image.







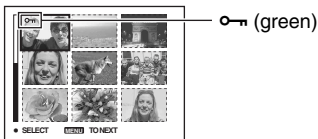

- ④ To protect other images, select the desired image with , then press .

### To protect images in index mode

- ① Press  (Index) to display the index screen.
- ② Press MENU to display the menu.
- ③ Select [Protect] with  on the control button, then press .
- ④ Select [Select] with , then press .
- ⑤ Select the image you want to protect with //, then press .  
A green  indicator appears on the selected image.



- ⑥ Repeat step ⑤ to protect other images.
  - ⑦ Press MENU.
  - ⑧ Select [OK] with , then press .  
The  indicator turns white. The selected images are protected.
- To protect all images in the folder, select [All In This Folder] in step ④, and press . Select [On] with , then press .

**To cancel the protection**

In single-image mode

Press ● in step ③ or ④ of “To protect images in single-image mode.”

In index mode

- ① Select the image for which you want to remove protection in step ⑤ of “To protect images in index mode.”
- ② Press ● to turn the  indicator gray.
- ③ Repeat the operation above for all images to be unprotected.
- ④ Press MENU, select [OK] with ►, and then press ●.

**To cancel protection of all images in the folder**

Select [All In This Folder] in step ④ of “To protect images in index mode,” and press ●. Select [Off] with ►, then press ●.

- Note that formatting the internal memory or “Memory Stick Duo” erases all the data stored on the recording media, even if the images are protected, and these images cannot be restored.
- It may take some time to protect an image.

**DPOF**

Adds a  (Print order) mark to images you want to print (page 85).

** (Print)**

See page 81.



** (Slide)**

See page 30.

** (Resize)**

You can change the image size of a recorded image (Resize), and save it as a new file. The original image is retained even after resizing.



|                                     |        |  |
|-------------------------------------|--------|--|
| <input type="checkbox"/>            | 7M     | The setting size is just a guideline.<br>→ step 4 in “Read This First” |
| <input type="checkbox"/>            | 5M     |  |
| <input type="checkbox"/>            | 3M     |  |
| <input type="checkbox"/>            | 2M     |  |
| <input type="checkbox"/>            | VGA    |  |
| <input checked="" type="checkbox"/> | Cancel | Cancels resizing.  |





- ① Display the image you want to resize.
- ② Press MENU to display the menu.
- ③ Select  (Resize) with /▶ on the control button, then press ●.
- ④ Select the desired size with ▲/▼, then press ●.  
The resized image is recorded in the recording folder as the newest file.

- For details on [Image Size] → *step 4 in "Read This First"*
- You cannot change the size of movies or Multi Burst images.
- When you change from a small size to a large size, the image quality deteriorates.
- You cannot resize to an image size of 3:2 or 16:9.
- When you resize a 3:2 or 16:9 image, the upper and lower black portions will be displayed on the image.

 (Rotate)

Rotates a still image.

|   |   |
|---|---|
|        | Rotates an image. See the following procedure.        |
| OK  | Determines the rotation. See the following procedure. |
|  Cancel | Cancels rotation.                                     |

- ① Display the image to be rotated.
- ② Press MENU to display the menu.
- ③ Select  (Rotate) with /▶ on the control button, then press ●.
- ④ Select  with ▲, then rotate the image with /▶.
- ⑤ Select [OK] with ▲/▼, then press ●.

- You cannot rotate protected images, movies, or Multi Burst images.
- You may not be able to rotate images shot with other cameras.
- When viewing images on a computer, the image rotation information may not be reflected depending on the software.

 (Divide)

Cuts movies, or deletes unnecessary scenes of movies. This is a recommended function to use when the internal memory or "Memory Stick Duo" capacity is insufficient, or when you attach movies to your e-mail messages.

- Note that the original movie is deleted and that number is skipped. Also note that you cannot restore files once you cut them.

|   |                              |
|---|------------------------------|
| OK  | See the following procedure. |
|  Cancel | Cancels division.            |



**Example: Cutting a movie numbered 101\_0002**

This section describes an example of dividing a movie numbered 101\_0002 and deleting it in the following file configuration.

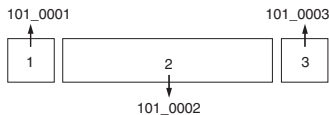
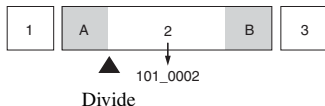

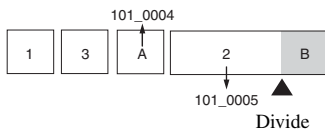

**1 Cutting scene A.**

101\_0002 is divided into 101\_0004 and 101\_0005.

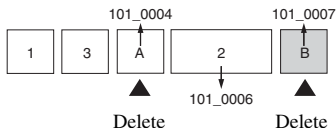
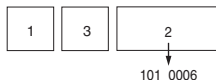
**2 Cutting scene B.**



101\_0005 is divided into 101\_0006 and 101\_0007.

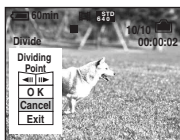

**3 Deleting scenes A and B if they are unnecessary.****4 Only the desired scenes remain.****Procedure**

- ① Display the movie to be divided.
  - ② Press MENU to display the menu.
  - ③ Select [Divide] with   on the control button, then press .
  - ④ Select [OK] with , then press .
- The movie starts.

- ⑤ Press  at the desired cutting point.



- When you want to adjust the cutting point, select [/||/▶] (frame rewind/forward) and adjust the cutting point using /▶.
- If you want to change the cutting point, select [Cancel]. The movie starts again.

- ⑥ Select [OK] with /▼, and press .

- ⑦ Select [OK] with ▲, then press .

The movie is cut.

- The cut movies are assigned new numbers, and then recorded as the newest files in the selected recording folder.
- You cannot cut the following kinds of images.
  - Still images
  - Movies not long enough to cut (shorter than about two seconds)
  - Protected movies (page 46)

## (Setup)







See page 51.

## Trimming



Records an enlarged image (→ step 6 in “Read This First”) as a new file.

|  |          |                              |
|--|----------|------------------------------|
|  | Trimming | See the following procedure. |
|  | Return   | Cancels trimming.            |

- ① Press MENU during playback zoom to display the menu.
- ② Select [Trimming] with ▶ on the control button, then press .
- ③ Select the image size with ▲/▼, then press .  
The image is recorded, and the original image is displayed again.

- The trimmed image is recorded as the newest file in the selected recording folder, and the original image is retained.
- The quality of trimmed images may deteriorate.
- You cannot trim to an image size of 3:2 or 16:9 aspect ratio.
- You cannot trim images displayed with Quick Review.



# Using Setup items

You can change the default settings using the Setup screen.

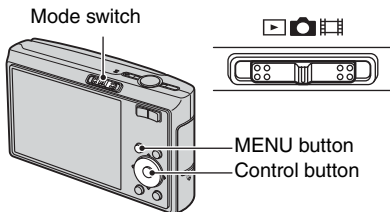
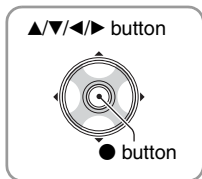

**1** Turn on the power.

**2** Press MENU to display the menu.

**3** After pressing **▶** on the control button, go to the **⚙️** (Setup) setting, then press **▶** again.

**4** Press **▲/▼/◀/▶** on the control button to select the item you want to set.

The frame of the selected item turns yellow.

**5** Press **●** to enter the setting.

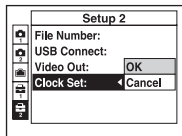

To turn off the **⚙️** (Setup) screen, press MENU.

To return to the menu from the **⚙️** (Setup) screen, press **◀** on the control button repeatedly.

- Press the shutter button halfway down to close the **⚙️** (Setup) screen and return to the shooting mode.

## When the menu is not displayed

Press MENU longer to display the **⚙️** (Setup) screen.

## To cancel the **⚙️** (Setup) setting

Select [Cancel] if it appears, then press **●** on the control button. If it does not appear, select the previous setting again.

- This setting is maintained even when the power is turned off.

The default settings are marked with .

## AF Mode

Selects the auto focus operation mode.

|  |                |   |
|--|----------------|---|
|  | Single (S AF)  | Automatically adjusts the focus when the shutter button is pressed and held halfway down. This mode is useful for shooting stationary subjects.   |
|  | Monitor (M AF) | Automatically adjusts the focus before the shutter button is pressed and held halfway down. This mode shortens the time needed for focusing. <ul style="list-style-type: none"> <li>• Battery consumption is faster than in [Single] mode.</li> </ul> |

## Digital Zoom

Selects the digital zoom mode. The camera enlarges the image using optical zoom (up to 3×). When the zoom scale exceeds 3×, the camera uses either smart or precision digital zoom.







|  |  |  |
|--|--|--|
|  | Smart<br>(Smart zoom)<br>                 | Enlarges the image digitally with almost no distortion. This is not available when the image size is set to [7M] or [3:2]. <ul style="list-style-type: none"> <li>• The maximum zoom scale of Smart zoom is shown in the following table.</li> </ul> |
|  | Precision<br>(Precision digital zoom)<br> | Enlarges all image sizes up to a maximum of 6×, but the image quality deteriorates.  |
|  | Off  | Does not use the digital zoom.   |

Image size and maximum zoom scale using Smart zoom

| Size | Maximum zoom scale |
|------|--------------------|
| 5M   | Approx. 3.6×       |
| 3M   | Approx. 4.5×       |
| 2M   | Approx. 5.6×       |
| VGA  | Approx. 14×        |
| 16:9 | Approx. 4.8×       |

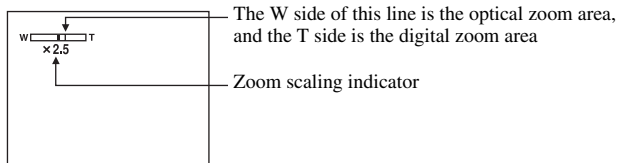
- When you press the zoom button, the zoom scaling indicator appears as follows.



- The maximum zoom scale of smart zoom/precision zoom includes the scale of the optical zoom.
- The AF range finder frame does not appear when using the digital zoom. The ,  or  indicator flashes, and AF operates with priority on subjects located near the center of the frame.
- When using the smart zoom, the image on the screen may look rough. However, this phenomenon has no effect on the recorded image.

## Function Guide

When you operate the camera, the description of functions is displayed.

|                                     |     |                                      |
|-------------------------------------|-----|--------------------------------------|
| <input checked="" type="checkbox"/> | On  | Displays the function guide.         |
| <input type="checkbox"/>            | Off | Does not display the function guide. |

## Red Eye Reduction

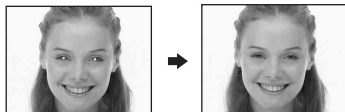

Reduces the red-eye phenomenon when using the flash. Select this before shooting.







|                                     |  |  |
|-------------------------------------|--|--|
| <input type="checkbox"/>            | On (  ) | Reduces the red-eye phenomenon. <ul style="list-style-type: none"> <li>The flash pre-strobes twice or more before shooting.</li> </ul> |
| <input checked="" type="checkbox"/> | Off  | Does not use Red Eye Reduction.  |

- Because it takes about a second until the shutter clicks, hold the camera firmly to prevent the effects of vibration. Also, do not let the subject move.
- Red-eye reduction may not produce the desired effects depending on individual differences, the distance to the subject, if the subject does not see the pre-strobe, or other conditions.

## AF Illuminator

The AF illuminator supplies fill light to focus more easily on a subject in dark surroundings. The AF illuminator emits red light allowing the camera to focus easily when the shutter button is pressed halfway, until the focus is locked. The  indicator appears at this time.

|                                     |      |                              |
|-------------------------------------|------|------------------------------|
| <input checked="" type="checkbox"/> | Auto | Uses the AF illuminator.     |
| <input type="checkbox"/>            | Off  | Does not use AF illuminator. |

- If the AF illuminator light does not reach the subject sufficiently or the subject has no contrast, focus will not be achieved. (A distance of up to approximately 2.7 m (106 3/8 inches) (zoom: W) / 2.5 m (98 1/2 inches) (zoom: T) is recommended.)
- Focus is achieved as long as the AF illuminator light reaches the subject, even if the light is slightly off the center of the subject.
- When Focus preset is set (page 38), AF Illuminator does not function.
- The AF range finder frame does not appear. The ,  or  indicator flashes, and AF operates with priority on subjects located near the center of the frame.
- The AF illuminator does not operate when  (Twilight mode),  (Landscape mode),  (High-speed shutter mode) or  (Fireworks mode) is selected in the Scene mode.
- The AF illuminator emits very bright light. Although there are no problems with safety, do not look directly into the AF illuminator emitter at close range.

## Auto Review

Displays the recorded image on the screen for approximately two seconds immediately after shooting a still image.

|                                     |     |                           |
|-------------------------------------|-----|---------------------------|
| <input checked="" type="checkbox"/> | On  | Use the Auto Review.      |
| <input type="checkbox"/>            | Off | Does not use Auto Review. |



- If you press the shutter button halfway down during this period, the recorded image display disappears and you can immediately shoot the next image.

The default settings are marked with ✓.

## STEADY SHOT

Selects the anti-blur mode.

|   |            |  |
|---|------------|--|
| ✓ | Shooting   | Activates the anti-blur function when pressing the shutter button halfway down.  |
|   | Continuous | Always activates the anti-blur function. You can stabilize images even when zooming up a far subject. <ul style="list-style-type: none"> <li>• Battery consumption is faster than in [Shooting] mode.</li> </ul> |

- When shooting movies, [Continuous] is activated even if you select [Shooting].
- You can turn off the anti-blur function using the  (STEADY SHOT) button when  (Camera) is not set to [Auto]. (→ step 5 in “Read This First”)
- The anti-blur function may not work properly in the following cases.
  - When camera shake is too strong
  - When the shutter speed is slow, for example, shooting night scenes



This item does not appear when a “Memory Stick Duo” is inserted in the camera.  
The default settings are marked with .

## Format

Formats the internal memory.

- Note that formatting irrevocably erases all data in the internal memory, including even protected images.

|  |        |                              |
|--|--------|------------------------------|
|  | OK     | See the following procedure. |
|  | Cancel | Cancels the formatting.      |

- ① Select [OK] with on the control button, then press .
- The message “All data in internal memory will be erased Ready?” appears.
- ② Select [OK] with , then press .
- The format is complete.







This item appears only when a “Memory Stick Duo” is inserted in the camera.  
The default settings are marked with .

## Format

Formats the “Memory Stick Duo”. A commercially available “Memory Stick Duo” is already formatted, and can be used immediately.

- Note that formatting irrevocably erases all data on a “Memory Stick Duo”, including even protected images.



|  |        |                              |
|--|--------|------------------------------|
|  | OK     | See the following procedure. |
|  | Cancel | Cancels the formatting.      |

- ① Select [OK] with  on the control button, then press .  
The message “All data in Memory Stick will be erased Ready?” appears.
- ② Select [OK] with , then press .  
The format is complete.



## Create REC. Folder

Creates a folder in a “Memory Stick Duo” for recording images.

|  |        |                              |
|--|--------|------------------------------|
|  | OK     | See the following procedure. |
|  | Cancel | Cancels folder creation.     |

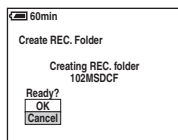
- ① Select [OK] with  on the control button, then press .  
The folder creation screen appears.





- ② Select [OK] with , then press .  
A new folder is created with a number incremented one higher than the largest number, and the folder becomes the current recording folder.

- For details on the folder, see page 45.
- When not creating a new folder, the “101MSDCF” folder is selected as the recording folder.
- You can create folders designated up to “999MSDCF”.
- Images are recorded in the newly created folder until a different folder is created or selected.
- You cannot delete a folder with the camera. To delete a folder, use your computer, etc.
- Up to 4,000 images can be stored in one folder. When the folder capacity is exceeded, a new folder is automatically created.
- For details, see “Image file storage destinations and file names” (page 71).

## Change REC. Folder

Changes the folder currently used for recording images.

|                                     |        |  |
|-------------------------------------|--------|--|
| <input type="checkbox"/>            | OK     | See the following procedure.           |
| <input checked="" type="checkbox"/> | Cancel | Cancels changing the recording folder. |

- ① Select [OK] with  on the control button, then press .  
The folder selection screen appears.

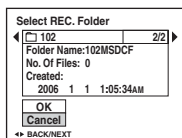





- ② Select the desired folder with , , and [OK] with , then press .

- You cannot select the “100MSDCF” folder as a recording folder.
- You cannot move recorded images to a different folder.



## Copy

Copies all images in the internal memory to a “Memory Stick Duo”.

|                                     |        |                              |
|-------------------------------------|--------|------------------------------|
| <input type="checkbox"/>            | OK     | See the following procedure. |
| <input checked="" type="checkbox"/> | Cancel | Cancels the copying.         |

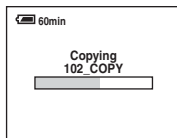
- ① Insert a “Memory Stick Duo” having 64 MB or larger capacity.
- ② Select [OK] with  on the control button, then press .  
The message “All data in internal memory will be copied Ready?” appears.
- ③ Select [OK] with , then press .  
Copying starts.



- Use a fully charged battery pack or the AC Adaptor (not supplied). If you attempt to copy image files using a battery pack with little remaining charge, the battery pack may run out, causing copying to fail or possibly corrupting the data.
- You cannot copy individual images.
- The original images in the internal memory are retained even after copying. To delete the contents of the internal memory, remove the “Memory Stick Duo” after copying, then execute the [Format] command in  (Internal Memory Tool) (page 56).
- You cannot select a folder copied on a “Memory Stick Duo”.
- Even if you copy data, a  (Print order) mark is not copied.

The default settings are marked with .

### Download Music

Downloads the music to be played for the Slide show.  
See pages 32, 77 and 79.

### Format Music

If you cannot play back a Music file for the Slide Show, the Music file might be corrupted. If this happens, perform [Format Music].

When [Format Music] is performed, all the Music files are erased. Use the supplied software "Music Transfer" to activate [Download Music].

The message "All data will be erased Ready?" appears.

|  |        |   |
|--|--------|---|
|  | OK     | Formats the Music files. All data other than Music files remain as it is. |
|  | Cancel | Cancels the formatting.   |

### LCD Backlight

Selects the brightness of the LCD backlight when using the camera with battery pack.

|  |        |            |
|--|--------|------------|
|  | Bright | Brightens. |
|  | Normal |            |

- You can change the setting by pressing  (Screen display switch) button longer.
- Selecting [Bright] uses up the battery pack charge faster.

### Beep

Selects the sound produced when you operate the camera.

|  |         |  |
|--|---------|--|
|  | Shutter | Turns on the shutter sound when you press the shutter button.                                |
|  | On      | Turns on the beep/shutter sound when you press the control button/ press the shutter button. |
|  | Off     | Turns off the beep/shutter sound.  |

### Language

Selects the language to be used to display the menu items, warnings, and messages.

## Initialize

Initializes the setting to the default setting.

|   |        |                              |
|---|--------|------------------------------|
|   | OK     | See the following procedure. |
| ✓ | Cancel | Cancels the resetting.       |

- ① Select [OK] with ▲ on the control button, then press ●.  
The message “Initialize all settings Ready?” appears.
  - ② Select [OK] with ▲, then press ●.  
The settings are reset to the default setting.
- Make sure that the power is not disconnected during resetting.

The default settings are marked with ✓.

## File Number

Selects the method used to assign file numbers to images.

|   |        |   |
|---|--------|---|
| ✓ | Series | Assigns numbers to files in sequence even if the recording folder or the “Memory Stick Duo” is changed. (When the replaced “Memory Stick Duo” contains a file with a number higher than the last assigned number, a number one higher than the largest number is assigned.) |
|   | Reset  | Starts from 0001 each time the folder is changed. (When the recording folder contains a file, a number one higher than the largest number is assigned.)   |

## USB Connect

Selects the USB mode to be used when connecting the camera to a computer or a PictBridge compliant printer using the cable for multi-use terminal.

|   |              |  |
|---|--------------|--|
|   | PictBridge   | Connects the camera to a PictBridge compliant printer (page 81).   |
|   | PTP          | When [PTP] (Picture Transfer Protocol) is set and the camera is connected to a computer, the images in the recording folder on the camera are copied to the computer. (Compatible with Windows XP and Mac OS X.)   |
|   | Mass Storage | Establishes a Mass Storage connection between the camera and a computer or other USB device (page 67).   |
| ✓ | Auto         | <p>The camera recognizes automatically and sets up communication with a computer or PictBridge compliant printer (pages 67 and 81).</p> <ul style="list-style-type: none"> <li>• If the camera and a PictBridge compliant printer cannot be connected when set to [Auto], change the setting to [PictBridge].</li> <li>• If the camera and a computer or other USB device cannot be connected when set to [Auto], change the setting to [Mass Storage].</li> </ul> |

## Video Out

Sets the video signal output according to the TV color system of the connected video equipment. Different countries and regions use different TV color systems. If you want to view images on a TV screen, check page 88 for the TV color system of the country or region where the camera is used.

|      |   |
|------|---|
| NTSC | Sets the video output signal to NTSC mode (e.g., for the USA, Japan). |
| PAL  | Sets the video output signal to PAL mode (e.g., for Europe).          |

## Clock Set

Sets the date and time.

|                                     |        |  |
|-------------------------------------|--------|--|
| <input type="radio"/>               | OK     | Select [OK] with ▲ on the control button, and press ●. Then, perform the procedure explained in “Set the clock” (→ <i>step 2 in “Read This First”</i> ). |
| <input checked="" type="checkbox"/> | Cancel | Cancels setting the clock.   |



# Enjoying your Windows computer

For details on using a Macintosh computer, refer to “Using your Macintosh computer” (page 78).

This section describes the English version of screen contents.



**Install the software (supplied) first (page 65)**



**Copying images to your computer (page 66)**



Viewing images on your computer

**Enjoying images using the “Cyber-shot Viewer” and “Music Transfer” (pages 73, 77)**



- Viewing images saved on your computer
- Viewing photos organized by date
- Editing images
- Adding/changing Music using “Music Transfer”



Printing images

## Recommended computer environment

The following environment is recommended for a computer connected to the camera.

### Recommended environment for copying images

**OS (pre-installed):** Microsoft Windows 2000 Professional, Windows Millennium Edition, Windows XP Home Edition or Windows XP Professional

- Operation is not assured in an environment based on an upgrade of the operating systems described above or in a multi-boot environment.

**USB jack:** Provided as standard

### Recommended environment for using “Cyber-shot Viewer” and “Music Transfer”

**OS (pre-installed):** Microsoft Windows 2000 Professional, Windows Millennium Edition, Windows XP Home Edition or Windows XP Professional

**Sound card:** 16-bit stereo sound card with speakers

**CPU/Memory:** Pentium III 500 MHz or faster, 128 MB of RAM or more (Recommended: Pentium III 800 MHz or faster and 256 MB of RAM or more)

**Software:** DirectX 9.0c or later

**Hard Disk:** Disk space required for installation—200 MB or more

**Display:** Screen resolution: 800 × 600 dots or more Colors: High Color (16-bit color, 65,000 colors) or more

- The software is compatible with DirectX technology. Installation of “DirectX” may be required.

## Notes on connecting your camera to a computer

- Operations are not guaranteed for all the recommended computer environments mentioned above.
- If you connect two or more USB devices to a single computer at the same time, some devices, including your camera, may not operate, depending on the types of USB devices you are using.
- Operations are not guaranteed when using a USB hub.
- Connecting your camera using a USB interface that is compatible with Hi-Speed USB (USB 2.0 compliant) allows advanced transfer (high speed transfer) as this camera is compatible with Hi-Speed USB (USB 2.0 compliant).
- There are three modes for a USB connection when connecting a computer, [Auto] (default setting), [Mass Storage] and [PTP] modes. This section describes the [Auto] and [Mass Storage] as examples. For details on [PTP], see page 61.
- When your computer resumes from a suspend or sleep mode, communication between your camera and your computer may not recover at the same time.

## Technical Support

Additional information on this product and answers to frequently asked questions can be found at the Sony Customer Support Website.  
<http://www.sony.net/>



# Installing the software (supplied)

You can install the software (supplied) using the following procedure.



- When using Windows 2000/Me, do not connect the camera to the computer before installation.
- In Windows 2000/XP, log on as Administrator.
- When the supplied software is installed, the USB driver is installed automatically.

---

## 1 Turn on your computer, and insert the CD-ROM (supplied) into the CD-ROM drive.

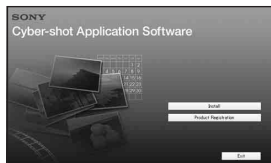
The installation menu screen appears.



- If it does not appear, double-click  (My Computer) →  (CYBERSHOTSOFI).

---

## 2 Click [Install].

The “Choose Setup Language” screen appears.

---

## 3 Select the desired language, then click [Next].

The “License Agreement” screen appears.

Read the agreement carefully. If you accept the terms of the agreement, click the radio button next to [I accept the terms of the license agreement] and then click [Next].

---

## 4 Follow the instructions on the screen to complete the installation.

When the restarting confirmation message appears, restart the computer following the instructions on the screen.

- DirectX may be installed depending on system environment of your computer.

---

## 5 Remove the CD-ROM after the installation is complete.

---

# Copying images to your computer

This section describes the process using a Windows computer as an example. You can copy images from the camera to your computer as follows.

## For a computer with a Memory Stick slot

Remove the “Memory Stick Duo” from the camera and insert it in the Memory Stick Duo Adaptor. Insert the Memory Stick Duo Adaptor in the computer and copy the images.

If the “Memory Stick PRO Duo” is not recognized, see page 97.

## For a computer without a Memory Stick slot

Follow Stages 1 through 4 on pages 66 to 70 to copy images.

- When you are using Windows 2000/Me, install the software (supplied) before proceeding. With Windows XP, installation is unnecessary.
- The screen displays shown in this section are the examples for copying images from “Memory Stick Duo”.

### Stage 1: Preparing the camera and the computer

#### 1 Insert a “Memory Stick Duo” with recorded images into the camera.

- When copying images in the internal memory, this step is unnecessary.

#### 2 Insert the sufficiently charged battery pack in the camera, or connect the camera to a wall outlet (wall socket) with the AC Adaptor (not supplied).

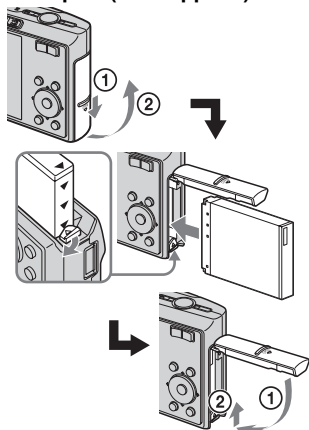

- When you copy images to your computer using a battery pack with little remaining charge, copying may fail or image data may become corrupted if the battery pack shuts down too soon.

- 3** Set the mode switch to , then turn on the camera and the computer.

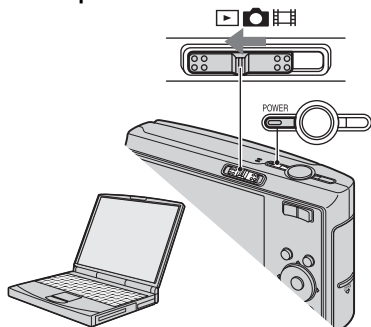

## Stage 2: Connecting the camera and your computer

- 1** Connect the camera to your computer.

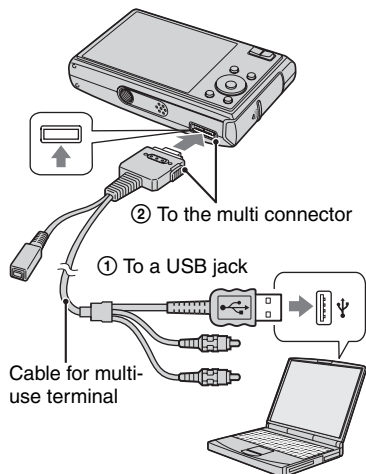

- 2** Set the switch on the cable for multi-use terminal to “CAMERA”.



- With Windows XP, the AutoPlay wizard appears on the desktop.

“USB Mode Mass Storage” appears on the screen of the camera.

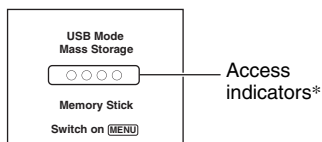

When a USB connection is established for the first time, your computer automatically runs a program to recognize the camera. Wait for a while.

- \* During communication, the access indicators turn red. Do not operate the computer until the indicators turn white.
- If “USB Mode Mass Storage” does not appear, set [USB Connect] to [Mass Storage] (page 61).

## Stage 3-A: Copying images to a computer

**XP**

- For Windows 2000/Me, follow the procedure explained in “Stage 3-B: Copying images to a Computer” on page 69.
- For Windows XP, when the wizard screen does not appear automatically, follow the procedure explained in “Stage 3-B: Copying images to a Computer” on page 69.

This section describes an example of copying images to a “My Documents” folder.

- 1 After making a USB connection in Stage 2, click [Copy pictures to a folder on my computer using Microsoft Scanner and Camera Wizard] → [OK] as the wizard screen appears automatically on the desktop.

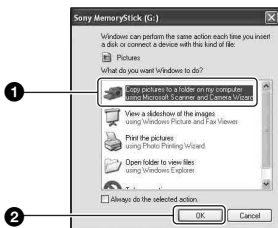

The “Scanner and Camera Wizard” screen appears.

- 2 Click [Next].

The images saved on the “Memory Stick Duo” of the camera appear.

- If no “Memory Stick Duo” is inserted, images in the internal memory appear.

- 3 Click the check box of unwanted images to remove the checkmark so they are not copied, then click [Next].



The “Picture Name and Destination” screen appears.

- 4 Select a name and destination for the images, then click [Next].

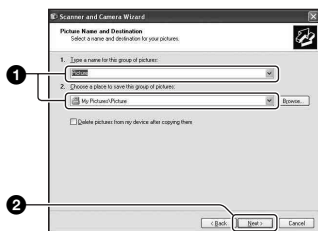

Image copying starts. When the copying is completed, the “Other Options” screen appears.

- This section describes an example of copying images to the “My Documents” folder.

- 5 Click the radio button next to [Nothing. I'm finished working with these pictures] to select it, then click [Next].



The “Completing the Scanner and Camera Wizard” screen appears.

## 6 Click [Finish].

The wizard screen closes.

- To continue copying other images, disconnect the cable for multi-use terminal (page 70). Then follow the procedure explained in “Stage 2: Connecting the camera and your computer” on page 67.

## Stage 3-B: Copying images to a Computer

2000 Me

- For Windows XP, follow the procedure explained in “Stage 3-A: Copying images to a computer” on page 67.

This section describes an example of copying images to the “My Documents” folder.

## 1 Double-click [My Computer] → [Removable Disk] → [DCIM].

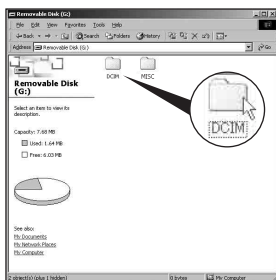

- If the “Removable Disk” icon is not displayed, see page 95.

## 2 Double-click the folder where the image files you want to copy are stored.

Then, right-click an image file to display the menu and click [Copy].

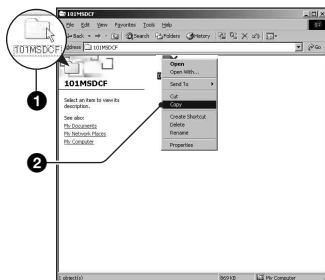

- On the storage destination of the image files, see page 71.

## 3 Double-click the [My Documents] folder. Then, right-click on the “My Documents” window to display the menu and click [Paste].

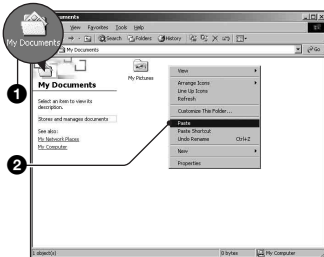

The image files are copied to the “My Documents” folder.

- When an image with the same file name exists in the copy destination folder, the overwrite confirmation message appears. When you overwrite an existing image with a new one, the original file data is deleted. To copy an image file to the computer without overwriting, change the file name to a different name and then copy the image file. However, note that if you change the file name (page 72), you may not be able to play back that image with your camera.

## Stage 4: Viewing images on your computer

This section describes the procedure for viewing copied images in the “My Documents” folder.

### 1 Click [Start] → [My Documents].

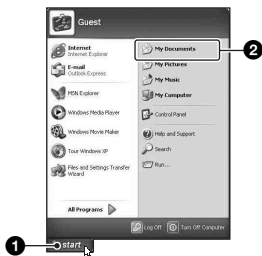

The contents of the “My Documents” folder are displayed.

- If you are not using Windows XP, double-click [My Documents] on the desktop.

### 2 Double-click the desired image file.



The image is displayed.

### To delete the USB connection

Perform the procedures listed below beforehand when:

- Disconnecting the cable for multi-use terminal
- Removing a “Memory Stick Duo”
- Inserting a “Memory Stick Duo” into the camera after copying images from the internal memory
- Turning off the camera

#### ■ For Windows 2000/Me/XP

- 1 Double-click on the taskbar.



Double-click here

- 2 Click (Sony DSC) → [Stop].
- 3 Confirm the device on the confirmation window, then click [OK].
- 4 Click [OK].  
The device is disconnected.
  - Step 4 is unnecessary for Windows XP.

## Image file storage destinations and file names

The image files recorded with your camera are grouped as folders on the “Memory Stick Duo”.

### Example: viewing folders on Windows XP

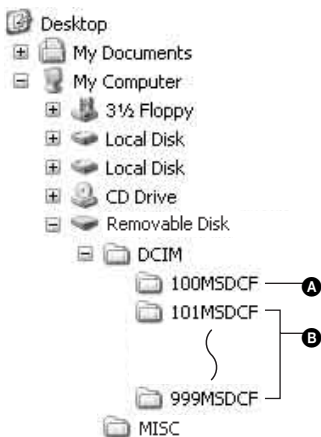

- A** Folder containing image data recorded using a camera not equipped with the folder creating function
  - B** Folder containing image data recorded using this camera  
When no new folders are created, there are folders as follows:
    - “Memory Stick Duo”; “101MSDCF” only
    - Internal memory; “101\_SONY” only
- You cannot record any images to the “100MSDCF” folder. The images in these folders are available only for viewing.
  - You cannot record/playback any images to the “MISC” folder.

- Image files are named as follows. □□□□ stands for any number within the range from 0001 to 9999. The numerical portions of the name of a movie file recorded in movie mode and its corresponding index image file are the same.
  - Still image files: DSC0□□□□.JPG
  - Movie files: MOV0□□□□.MPG
  - Index image files that are recorded when you record movies: MOV0□□□□.THM
- For more information about folders, see pages 45, 57.

# Viewing image files stored on a computer with your camera (using a “Memory Stick Duo”)

This section describes the process using a Windows computer as an example.

When an image file copied to a computer no longer remains on a “Memory Stick Duo”, you can view that image again on the camera by copying the image file on the computer to a “Memory Stick Duo”.

- Step 1 is not necessary if the file name set with your camera has not been changed.
- You may be unable to play back some images depending on the image size.
- When an image file has been processed by a computer or when the image file was recorded using a model other than that of your camera, playback on your camera is not guaranteed.
- When there is no folder, create a folder with your camera (page 57) first, and then copy the image file.

## 1 Right-click the image file, then click [Rename]. Change the file name to “DSC0□□□□.”

Enter a number from 0001 to 9999 for □□□□.



- If the overwrite confirmation message appears, enter a different number.
- An extension may be displayed depending on the computer settings. The extension for still images is JPG, and the extension for movies is MPG. Do not change the extension.

## 2 Copy the image file to the “Memory Stick Duo” folder in the following order.

- ① Right-click the image file, then click [Copy].
- ② Double-click [Removable Disk] or [Sony MemoryStick] in [My Computer].
- ③ Right-click the [□□□MSDCF] folder in the [DCIM] folder, then click [Paste].
  - □□□ stands for any number within the range from 100 to 999.

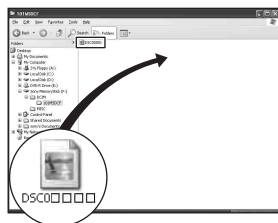



# Using the “Cyber-shot Viewer” (supplied)

You can use still images and movies from the camera more than ever by taking advantage of the software.

This section summarizes the “Cyber-shot Viewer” and gives the basic instructions.

## “Cyber-shot Viewer” overview

With the “Cyber-shot Viewer” you can:

- Import images shot with the camera and display them on the computer.
- Organize images on the computer on a calendar by shooting date to view them.
- Retouch, print, and send still images as e-mail attachments, change the shooting date, and more.
- For details on the “Cyber-shot Viewer”, refer to the Help.

To access the Help, click [Start] → [Programs] (in Windows XP, [All Programs]) → [Sony Picture Utility] → [Help] → [Cyber-shot Viewer].

## Starting and exiting the “Cyber-shot Viewer”

### Starting the “Cyber-shot Viewer”

Double-click the  (Cyber-shot Viewer) icon on the desktop.

Or, from the Start menu: Click [Start] → [Programs] (in Windows XP, [All Programs]) → [Sony Picture Utility] → [Cyber-shot Viewer].

### Exiting the “Cyber-shot Viewer”

Click  button in the top right corner of the screen.

## Basic instructions

Follow these steps to import and view images from the camera.

### Importing images

#### 1 Make sure “Media Check Tool”\* is running.

\* “Media Check Tool” is a program that automatically detects and imports images when a “Memory Stick” is inserted or when the camera is connected.

Look for a  (Media Check Tool) icon in the taskbar.

- If there is no  icon: Click [Start] → [Programs] (in Windows XP, [All Programs]) → [Sony Picture Utility] → [Cyber-shot Viewer] → [Tools] → [Media Check Tool].

#### 2 Connect the camera to your computer with the cable for multi-use terminal.

After the camera is automatically detected, the [Import Images] screen is displayed.

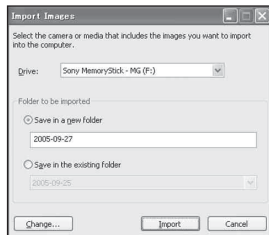

- If you use the Memory Stick slot, refer to page 66 first.
- In Windows XP, if the Auto Play Wizard appears, close it.

### 3 Import the images.

To start importing images, click the [Import] button.

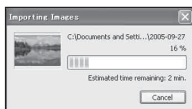

By default, images are imported into a folder created in “My Pictures” that is named with the date of importing.

- For instructions on changing the “Folder to be imported”, refer to page 76.

## Viewing images

### 1 Checking imported images

When importing is complete, the “Cyber-shot Viewer” starts. Thumbnails of the imported images are displayed.

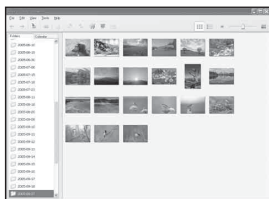

- The “My Pictures” folder is set as the default folder in “Viewed folders”.
- You can double-click a thumbnail to display the image by itself.

### 2 Viewing images in “Viewed folders” arranged by shooting date on a calendar

- ① Click the [Calendar] tab.  
Years when images were shot are listed.
- ② Click the year.  
Images shot that year are displayed, arranged on the calendar by shooting date.
- ③ To display images by month, click the desired month.  
Thumbnails of images shot that month are displayed.
- ④ To display images by time, click the desired date.  
Thumbnails of images shot that day are displayed, arranged by hour.

Year display screen

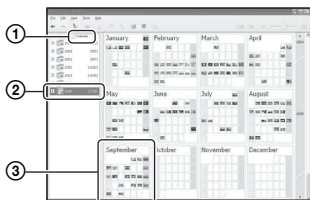

Month display screen

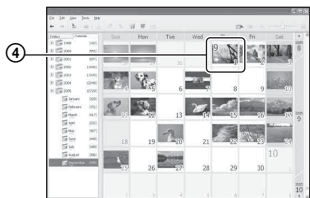

## Hour display screen

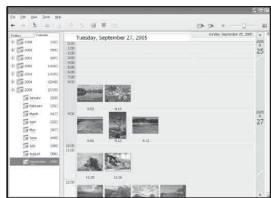

- To list images from a particular year or month, click that period on the left of the screen.

## 3 Displaying individual images

On the hour display screen, double-click a thumbnail to display the image by itself in a separate window.





- You can edit displayed images by clicking the  toolbar button.

## 4 Displaying images in full-screen mode

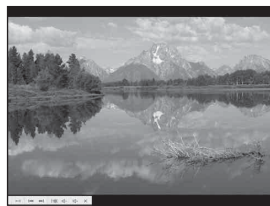
To display a slide show of current images in full-screen mode, click the  button.



- To play or pause the slide show, click the  button on the lower left of the screen.
- To stop the slide show, click the  button on the lower left of the screen.

## Other functions

### Preparing images stored on the computer for viewing

To view images, register the folder that contains the images as one of the “Viewed folders”.

From the [File] menu, choose [Register Viewed Folders...] to display the settings screen for “Viewed folders” registration.

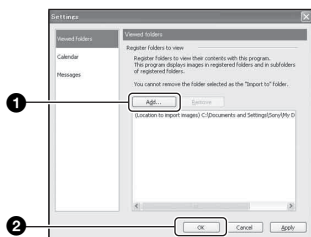

Click the [Add...] button, and then specify the folder with images for importing to register the folder as a “Viewed folder.”

- Images in any subfolders of “Viewed folders” are also registered.

### Changing the “Folder to be imported”

To change the “Folder to be imported”, access the “Import Settings” screen.

To display the “Import Settings” screen, choose [Image Import Settings...] from the [File] menu.

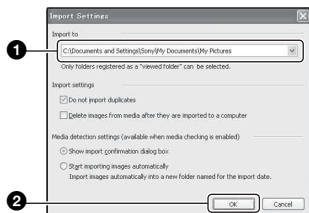

Choose the “Folder to be imported”.

- You can specify the “Folder to be imported” from folders registered as “Viewed folders.”

### Updating image registration information

To update image information, choose [Update Database] from the [Tools] menu.

- Updating the database may take a while.
- If you rename image files or folders in “Viewed folders”, they cannot be displayed with this software. In this case, update the database.

### Uninstalling “Cyber-shot Viewer”

- 1 Click [Start] → [Settings] → [Control Panel]. Double-click [Add/Remove Programs]. (For Windows XP, click [start] → [Control Panel], then double-click [Add or Remove Programs].)
- 2 Select [Sony Picture Utility] and click [Change/Remove] (for Windows XP, [Remove]) to uninstall.

# Using the “Music Transfer” (supplied)

You can change the Music files that are preset at the factory with desired Music files using “Music Transfer” in the CD-ROM (supplied). Also, you can delete or add these files whenever you want.

## Adding/Changing Music using “Music Transfer”

The music formats you can transfer with “Music Transfer” are listed below:

- MP3 files stored on the hard drive of your computer
- Music on CDs
- Preset-music saved on this camera

- To restore the music preset at the factory to the camera:

① Perform [Format Music] (page 59).

② Execute [Restore defaults] on “Music Transfer.”

All Music files return to the preset-music, and [Music] in the [Slide] menu is set to [Off].

③ Select a suitable Music file for the slide show effect (page 31).

You can reset the Music files to the preset ones using [Initialize], however, other settings will also be reset.

- For details on using “Music Transfer,” see the on-line help in “Music Transfer.”

---

**1** Press **MENU** to display the menu.

---

**2** Select  (Setup) with **▶** on the control button.

---

**3** Select  (Setup1) with **▲/▼** on the control button, then select [Download Music] with **▲/▶**.

---

**4** Select [OK] with **▶/▲**, press **●**.

The message “Connect to PC” appears.

---

**5** Make a USB connection between the camera and your computer.

---

**6** Start “Music Transfer.”

---

**7** Follow the instructions on the screen to add/change Music files.

---

# Using your Macintosh computer

You can copy images to your Macintosh computer.

- “Cyber-shot Viewer” is not compatible with Macintosh computers.

## Recommended computer environment

The following environment is recommended for a computer connected to the camera.

### Recommended environment for copying images

**OS (pre-installed):** Mac OS 9.1, 9.2, or Mac OS X (v10.0 or later)

**USB jack:** Provided as standard

### Recommended environment for using “Music Transfer”

**OS (pre-installed):** Mac OS X (v10.3 or later)

**CPU:** iMac, eMac, iBook, PowerBook, Power Mac G3/G4/G5 series, Mac mini

**Memory:** 64 MB or more (128 MB or more is recommended)

**Hard Disk:** Disk space required for installation—approximately 250 MB

### Notes on connecting your camera to a computer

- Operations are not guaranteed for all the recommended computer environments mentioned above.
- If you connect two or more USB devices to a single computer at the same time, some devices, including your camera, may not operate depending on the types of USB devices you are using.
- Operations are not guaranteed when using a USB hub.
- Connecting your camera using a USB interface that is compatible with Hi-Speed USB (USB 2.0 compliant) allows advanced transfer (high speed transfer) as this camera is compatible with Hi-Speed USB (USB 2.0 compliant).

- There are three modes for a USB connection when connecting a computer, [Auto] (default setting), [Mass Storage] and [PTP] modes. This section describes the [Auto] and [Mass Storage] as examples. For details on [PTP], see page 61.
- When your computer resumes from the suspend or sleep mode, communication between your camera and your computer may not recover at the same time.

## Copying and viewing images on a computer

### 1 Prepare the camera and a Macintosh computer.

Perform the same procedure as described in “Stage 1: Preparing the camera and the computer” on page 66.

### 2 Connect the cable for multi-use terminal.

Perform the same procedure as described in “Stage 2: Connecting the camera and your computer” on page 67.

### 3 Copy image files to the Macintosh computer.

- ① Double-click the newly recognized icon → [DCIM] → the folder where the images you want to copy are stored.
  - ② Drag and drop the image files to the hard disk icon.  
The image files are copied to the hard disk.
- For details on the storage location of the images and file names, see page 71.

## 4 View images on the computer.

Double-click the hard disk icon → the desired image file in the folder containing the copied files to open that image file.

### To delete the USB connection

Perform the procedures listed below beforehand when:

- Disconnecting the cable for multi-use terminal
- Removing a “Memory Stick Duo”
- Inserting a “Memory Stick Duo” into the camera after copying images from the internal memory
- Turning off the camera

### Drag and drop the drive icon or the icon of the “Memory Stick Duo” to the “Trash” icon.

The camera is disconnected from the computer.

- If you are using Mac OS X v10.0, perform the procedure above after you have turned your computer off.

### Adding/Changing Music using “Music Transfer”

You can change the Music files that are preset at the factory with desired Music files. Also, you can delete or add these files whenever you want.

The music formats you can transfer with “Music Transfer” are listed below:

- MP3 files stored on the hard drive of your computer
- Music on CDs
- Preset-music saved on this camera

### To install “Music Transfer”

- Shut down all other application software before you install “Music Transfer.”
- For installation, you need to log on as Administrator.

- ① Turn on your Macintosh computer, and insert the CD-ROM (supplied) into the CD-ROM drive.
- ② Double-click  (CYBERSHOTSOFT).
- ③ Double-click the [MusicTransfer.pkg] file in [MAC] folder.  
The installation of the software starts.

### To add/change Music files

See “Adding/Changing Music using “Music Transfer”” on page 77.

### Technical Support

Additional information on this product and answers to frequently asked questions can be found at the Sony Customer Support Website.  
<http://www.sony.net/>



## How to print still images

When you print images shot in [16:9] mode, both edges may be cut off, so be sure to check before printing (page 98).

### Printing directly using a PictBridge compliant printer (page 81)

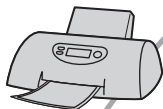

You can print images by connecting the camera directly to a PictBridge compliant printer.

### Printing directly using a “Memory Stick” compliant printer



You can print images with a “Memory Stick” compliant printer. For details, see the operating instructions supplied with the printer.

### Printing using a computer



You can copy images to a computer using the supplied “Cyber-shot Viewer” software and print the images.

### Printing at a shop (page 85)

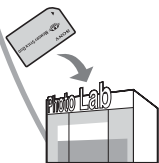

You can take a “Memory Stick Duo” containing images shot with your camera to a photo printing service shop. You can make a  (Print order) mark on images which you want to print out in advance.



# Printing images directly using a PictBridge compliant printer

Even if you do not have a computer, you can print images shot using your camera by connecting the camera directly to a PictBridge compliant printer.

## PictBridge

- “PictBridge” is based on the CIPA standard. (CIPA: Camera & Imaging Products Association)

### In single-image mode

You can print a single image on a printing sheet.



### In index mode

You can print several images at a reduced size on a printing sheet. You can print a set of either the same images (①) or different images (②).

①

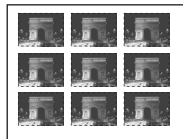

②



- An index print function may not be provided depending on the printer.
- The quantity of images that can be printed as an index image differ depending on the printer.
- You cannot print movies.
- If the  indicator flashes on the screen of the camera for about five seconds (error notification), check the connected printer.

## Stage 1: Preparing the camera

Prepare the camera to connect it to the printer with the cable for multi-use terminal. When connecting the camera to a printer that is recognized when [USB Connect] is set to [Auto], Stage 1 is unnecessary.

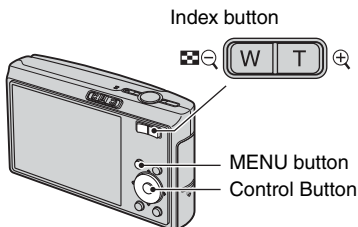

- It is recommended to use a fully charged battery pack or an AC Adaptor (not supplied) to prevent the power from turning off partway through printing.

**1** Press **MENU** to display the menu.

**2** Press **▶** on the control button to select  (Setup).

**3** Select  (Setup2) with **▼**, then select [USB Connect] with **▲/▼/▶**.

**4** Select [PictBridge] with **▶/▲**, then press **●**.

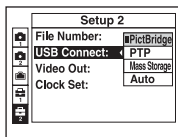

The USB mode is set.

## Stage 2: Connecting the camera to the printer

### 1 Connect the camera to the printer.

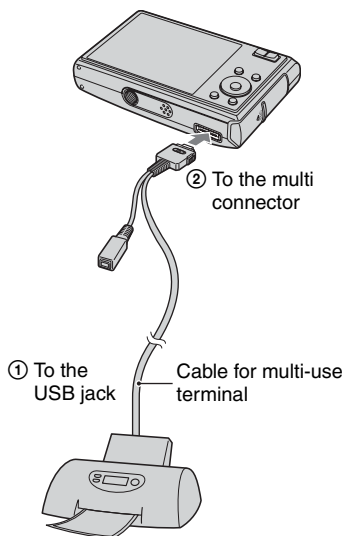

### 2 Set the switch on the cable for multi-use terminal to “CAMERA”.



### 3 Turn on your camera and the printer.

After the connection is made, the  indicator appears.

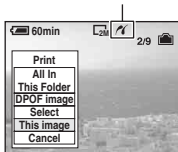

The camera is set to playback mode, then an image and the print menu appear on the screen.

## Stage 3: Printing

Regardless of what the mode switch is set to, the print menu appears when you complete Stage 2.

### 1 Select the desired printing method with $\blacktriangle/\blacktriangledown$ on the control button, then press $\bullet$ .

#### [All In This Folder]

Prints all the images in the folder.

#### [DPOF image]

Prints all the images with a  (Print order) mark (page 85) regardless of the displayed image.

#### [Select]

Selects images and prints all the selected images.

① Select the image you want to print with  $\blacktriangle/\blacktriangledown$ , then press  $\bullet$ .

The  $\checkmark$  mark appears on the selected image.

- To select other images, repeat this procedure.

② Select [Print] with  $\blacktriangledown$ , then press  $\bullet$ .

## [This image]

Prints a displayed image.

- If you select [This image] and set [Index] to [On] in step 2, you can print a set of the same images as an index image.

## 2 Select print settings with ▲/▼/◀/▶.

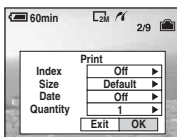

### [Index]

Select [On] to print as an index image.

### [Size]

Select the size of the printing sheet.

### [Date]

Select [Day&Time] or [Date] to insert the date and time on images.

- When you choose [Date], the date will be inserted in the order you select (→ step 2 in “Read This First”). This function may not be provided depending on the printer.

### [Quantity]

When [Index] is set to [Off]:

Select the number of sheets of an image that you want to print. The image will be printed as a single image.

When [Index] is set to [On]:

Select the number of sets of images that you want to print as an index image. If you selected [This image] in step 1, select the number of the same image you want to print side by side on a sheet as an index image.

- The designated number of images may not all fit onto a single sheet depending on the quantity of images.

## 3 Select [OK] with ▼/▶, then press ●.

The image is printed.

- Do not disconnect the cable for multi-use terminal while the  (PictBridge Connecting) indicator appears on the screen.

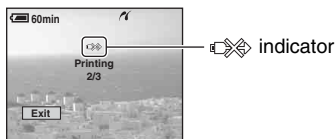



## To print other images

After step 3, select [Select] and the desired image with ▲/▼, then perform from step 1.

## To print images on the index screen

Perform “Stage 1: Preparing the camera” (page 81) and “Stage 2: Connecting the camera to the printer” (page 82), then proceed with the following.

When you connect the camera to a printer, the print menu appears. Select [Cancel] to turn off the print menu, then proceed as follows.

- ① Press  (Index).  
The index screen appears.
- ② Press MENU to display the menu.
- ③ Select  (Print) with ▶, then press ●.
- ④ Select the desired printing method with ▲/▼, then press ●.



**[Select]**

Selects images and prints all the selected images.

Select the image you want to print with ▲/▼/◀/▶, then press ● to display the ✓ mark. (Repeat this procedure to select other images.) Then, press MENU.

**[DPOF image]**

Prints all the images with a  (Print order) mark regardless of the displayed image.

**[All In This Folder]**

Prints all the images in the folder.

- ⑤ Perform steps 2 and 3 of “Stage 3: Printing” (page 82).

# Printing at a shop

You can take a “Memory Stick Duo” containing images shot with your camera to a photo printing service shop. As long as the shop supports photo printing services conforming to the DPOF, you can make a  (Print order) mark on images in advance so that you do not need to reselect them when you print them out at the shop.

- You cannot print images stored in the internal memory at a print shop directly from the camera. Copy the images to a “Memory Stick Duo”, then take the “Memory Stick Duo” to the print shop.

## What is DPOF?

DPOF (Digital Print Order Format) is a function allowing you to make a  (Print order) mark on images of “Memory Stick Duo” that you want to print out later.

- You can also print the images with the  (Print order) mark using a printer that conforms to the DPOF (Digital Print Order Format) standard or using a PictBridge compliant printer.
- You cannot mark movies.
- When you mark images shot in [Multi Burst] mode, all the images are printed on one sheet divided into 16 panels.

## When taking a “Memory Stick Duo” to a shop

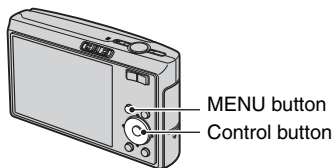

- Consult your photo printing service shop as to what types of “Memory Stick Duo” they handle.
- If a “Memory Stick Duo” is not handled by your photo printing service shop, copy the images you want to print out to other medium such as a CD-R and take it to the shop.
- Be sure to take the Memory Stick Duo Adaptor with it.
- Before you take image data to a shop, always copy (back up) your data to a disk.
- You cannot set the number of prints.

## Marking in single-image mode





**1** Display the image you want to print.

**2** Press MENU to display the menu.

**3** Select DPOF with , then press .

A  (Print order) mark is marked on the image.



**4** To mark other images, display the desired image with , then press .

## To remove the mark in single-image mode

Press  in step 3 or 4.

## Marking in index mode

**1** Display the index screen (→ *step 6 in "Read This First"*).

**2** Press MENU to display the menu.

**3** Select DPOF with ◀/▶, then press ●.

**4** Select [Select] with ▲/▼, then press ●.

- You cannot add a  mark in [All In This Folder].

**5** Select the image you want to mark with ▲/▼/◀/▶, then press ●.

A green  mark appears on the selected image.



Green  mark

**6** Repeat step 5 to mark other images.

**7** Press MENU.

**8** Select [OK] with ▶, then press ●.

The  mark turns white.

To cancel, select [Cancel] in step 4 or select [Exit] in step 8, then press ●.

### To remove the mark in index mode

Select the images from which you want to remove the mark in step 5, then press ●.

### To remove all the marks in the folder

Select [All In This Folder] in step 4, then press ●. Select [Off], then press ●.



# Viewing images on a TV screen

You can view images on a TV screen by connecting the camera to a TV.

Turn off both your camera and the TV before connecting the camera and the TV.

## 1 Connect the camera to the TV.

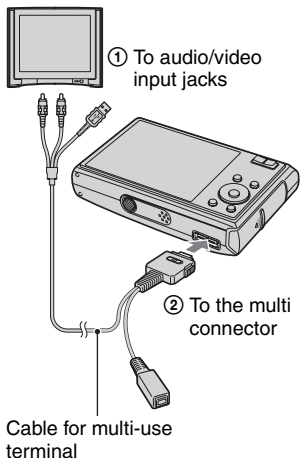

- Place the camera with the screen facing upwards.
- If your TV has stereo input jacks, connect the audio plug (black) of the cable for multi-use terminal to the left audio jack.

## 2 Set the switch on the cable for multi-use terminal to "TV".





## 3 Turn on the TV and set the TV/ video input switch to "video."

- For details, see the operating instructions supplied with the TV.

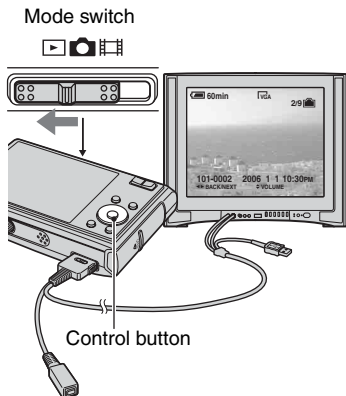
## 4 Set the mode switch to , and turn on the camera.



Images shot with the camera appear on the TV screen.

Press   on the control button to select the desired image.

- When using your camera abroad, it may be necessary to switch the video signal output to match that of your TV system (page 62).

## **On TV color systems**

If you want to view images on a TV screen, you need a TV with a video input jack and the cable for multi-use terminal. The color system of the TV must match that of your digital still camera. Check the following lists for the TV color system of the country or region where the camera is used.

### **NTSC system**

Bahama Islands, Bolivia, Canada, Central America, Chile, Colombia, Ecuador, Jamaica, Japan, Korea, Mexico, Peru, Surinam, Taiwan, the Philippines, the U.S.A., Venezuela, etc.

### **PAL system**

Australia, Austria, Belgium, China, Czech Republic, Denmark, Finland, Germany, Holland, Hong Kong, Hungary, Italy, Kuwait, Malaysia, New Zealand, Norway, Poland, Portugal, Singapore, Slovak Republic, Spain, Sweden, Switzerland, Thailand, United Kingdom, etc.

### **PAL-M system**

Brazil

### **PAL-N system**

Argentina, Paraguay, Uruguay

### **SECAM system**

Bulgaria, France, Guiana, Iran, Iraq, Monaco, Russia, Ukraine, etc.





If you experience trouble with your camera, try the following solutions.

**1 Check the items on pages 90 to 100.**

If a code such as “C/E:□□:□□” appears on the screen, see page 101.

**2 Remove the battery pack, and insert the battery pack again after about one minute, and turn on the power.**

**3 Initialize the settings (page 60).**

**4 Consult your Sony dealer or local authorized Sony service facility.**

Please understand that you give your consent that the contents of the internal memory, Music files may be checked when you send your camera to be repaired.

## Battery pack and power

### The battery pack cannot be installed.

- As you insert the battery pack, use the tip of the battery pack to push the battery eject lever toward the bottom of the camera (→ *step 1 in “Read This First”*).
- Install the battery pack correctly (→ *step 1 in “Read This First”*).

---

### The battery remaining indicator is incorrect, or sufficient battery remaining indicator is displayed but the power runs out too quickly.

- This phenomenon occurs when you use the camera in an extremely hot or cold location (page 106).
- The displayed battery remaining differs from the current one. Fully discharge and then charge the battery pack to correct the display.
- The battery pack is discharged. Install the charged battery pack (→ *step 1 in “Read This First”*).
- The battery pack is dead (page 106). Replace it with a new one.

---

### The battery pack runs down too quickly.

- Charge it sufficiently (→ *step 1 in “Read This First”*).
- You are using the camera in an extremely cold location (page 106).
- The battery terminal is dirty. Clean the battery terminal with a cotton swab, etc., and charge the battery pack.
- The battery pack is dead (page 106). Replace it with a new one.

---

### Cannot turn on the camera.

- Install the battery pack correctly (→ *step 1 in “Read This First”*).
- The battery pack is discharged. Install charged battery pack (→ *step 1 in “Read This First”*).
- The battery pack is dead (page 106). Replace it with a new one.



---

### The power turns off suddenly.

- If you do not operate the camera for about three minutes while the power is on, the camera turns off automatically to prevent wearing down the battery pack. Turn on the camera again (→ *step 2 in “Read This First”*).
- The battery pack is discharged. Install charged battery pack (→ *step 1 in “Read This First”*).

## Shooting still images/movies

### Your camera cannot record images.

- Check the free capacity of the internal memory or “Memory Stick Duo” (pages 24, 25). If it is full, do one of the following:
  - Delete unnecessary images (→ *step 6 in “Read This First”*).
  - Change the “Memory Stick Duo”.
- You are using the “Memory Stick Duo” with the write-protect switch, and the switch is set to the LOCK position. Set the switch to the recording position (page 104).
- You cannot record images while charging the flash.
- Set the mode switch to  when shooting still images.
- Set the mode switch to  when shooting movies.
- The image size is set to [640(Fine)] when recording movies. Do one of the following:
  - Set the image size to other than [640(Fine)].
  - Insert a “Memory Stick PRO Duo” (page 104).







### The subject is not visible on the screen.

- Set the mode switch to a position other than  (page 28).

### Recording takes a long time.

- The NR slow shutter function is activated (page 20). This is not a malfunction.

### The image is out of focus.

- The subject is too close. Shoot in  (Macro) recording mode. Make sure to position the lens farther away from the subject than the shortest shooting distance, approximately 8 cm (3 1/4 inches) (W)/25 cm (9 7/8 inches) (T), when shooting. Or, set  (Magnifying Glass) and focus from a distance of approx. 1 cm to 20 cm (13/32 inch to 7 7/8 inches) from the subject (→ *step 5 in “Read This First”*).
-  (Magnifying Glass) is set, or  (Twilight mode),  (Landscape mode) or  (Fireworks mode) is selected in the Scene mode when shooting still images.
- The Focus preset function is selected. Select the auto focus mode (page 38).
- Refer to “If the subject is out of focus” on page 39.

### Optical zoom does not work.

- When  (Magnifying Glass) is selected, the optical zoom is not available.

### Precision digital zoom does not function.

- Set [Digital Zoom] to [Precision] (page 52).
- This function cannot be used while shooting movies.











---

### Smart zoom does not function.

- Set [Digital Zoom] to [Smart] (page 52).
- This function cannot be used when:
  - The image size is set to [7M] or [3:2].
  - Shooting in Multi Burst mode.
  - Shooting movies.

---

### The flash does not work.

- The flash is set to  (Flash forced off) (→ *step 5 in “Read This First”*).
- You cannot use the flash when:
  - [Mode] (REC Mode) is set to [Burst], [Exp Brktg] or [Multi Burst] (page 42).
  -  (High sensitivity mode),  (Twilight mode) or  (Fireworks mode) is selected in the Scene mode (page 29).
  - When the mode switch is set to .
- Set the flash to  (Flash forced on) when  (Magnifying Glass) is set, or  (Landscape mode),  (Snow mode),  (Beach mode) or  (High-speed shutter mode) is selected in the Scene mode (→ *step 5 in “Read This First”*).



---

### Fuzzy specks appear in images shot using the flash.

- Dust in the air reflected the flash light and appeared in the image. This is not a malfunction.

---

### The close-up shoot function does not work.

-  (Twilight mode),  (Landscape mode) or  (Fireworks mode) is selected in the Scene mode (page 29).

---

### The date and time are not displayed.

- While shooting, the date and time are not displayed. They are displayed only during playback.

---

### The date and time are recorded incorrectly.

- Set the correct date and time (→ *step 2 in “Read This First”*).

---

### The F value and shutter speed flash when you press and hold the shutter button halfway down.

- The exposure is incorrect. Correct the exposure (page 37).

---

### The image is too dark.

- You are shooting a subject with a light source behind the subject. Select the metering mode (page 40) or adjust the exposure (page 37).
- The brightness of the screen is too low. Adjust the brightness of the LCD backlight (page 23).

---

**The image is too bright.**

- You are shooting a spotlighted subject in a dark location such as on a stage. Adjust the exposure (page 37).
- The brightness of the screen is too bright. Adjust the brightness of the LCD backlight (page 23).

---

**The image colors are not correct.**

- Set [COLOR] (Color Mode) to [Normal] (page 36).

---

**Vertical streaks appear when you are shooting a very bright subject.**

- The smear phenomenon is occurring. This phenomenon is not a malfunction.

---

**Noise appears in the image when you view the screen in a dark place.**

- The camera is attempting to increase the visibility of the screen by temporarily brightening the image under conditions of low illumination. There is no effect on the recorded image.

---

**The eyes of the subject come out red.**

- Set [Red Eye Reduction] in the  (Setup) menu to [On] (page 53).
- Shoot the subject at a distance closer than the recommended shooting distance using the flash (→ step 5 in “Read This First”).
- Light the room and shoot the subject.

---

**Dots appear and remain on the screen.**

- This is not a malfunction. These dots are not recorded (page 8, → “Read This First”).

---

**Cannot shoot images in succession.**

- The internal memory or “Memory Stick Duo” is full. Delete unnecessary images (→ step 6 in “Read This First”).
- The battery level is low. Install charged battery pack.

## Viewing images

Refer to “Computers” (page 95) in conjunction with the following items.

---

**Your camera cannot play back images.**

- Set the mode switch to  (page 28).
- The folder/file name has been changed on your computer (page 72).
- When an image file has been processed by a computer or when the image file was recorded using a model other than that of your camera, playback on your camera is not guaranteed.
- The camera is in USB mode. Delete the USB connection (page 70).

---

**The date and time are not displayed.**

- (Screen display switch) button is turned off (page 23).

---

**The image appears rough right after playback starts.**

- The image may appear rough right after playback starts due to image processing. This is not a malfunction.

---

**The image does not appear on the screen when a USB connection is made.**

- The switch on the cable for multi-use terminal is set to “TV”. Disconnect the cable for multi-use terminal or set the switch to “CAMERA” (page 67).

---

**The image does not appear on the TV screen.**

- Check [Video Out] to see if the video output signal of your camera is set to the color system of your TV (page 62).
- Check whether the connection is correct (page 87).
- The switch on the cable for multi-use terminal is set to “CAMERA”. Set to “TV” (page 87).

## Deleting/Editing images

---

**Your camera cannot delete an image.**

- Cancel the protection (page 47).
- You are using the “Memory Stick Duo” with the write-protect switch, and the switch is set to the LOCK position. Set the switch to the recording position (page 104).

---

**You have deleted an image by mistake.**

- Once you have deleted an image, you cannot restore it. We recommend that you protect images (page 46), or use the “Memory Stick Duo” with the write-protect switch and set the switch to the LOCK position (page 104) to prevent accidental erasure.

---

**The resizing function does not work.**

- You cannot resize movies and Multi Burst images.

---

**You cannot display a DPOF (Print order) mark.**

- You cannot display DPOF (Print order) marks on movies.

---

**You cannot cut a movie.**

- The movie is not long enough to cut (shorter than about two seconds).
- Cancel the protection (page 47).
- Still images cannot be cut.

## Computers

### You do not know if the OS of your computer is compatible with the camera.

- Check “Recommended computer environment” on page 64 for Windows, and page 78 for Macintosh.

---

### Nothing appears on the camera screen when a USB connection is made.

- The switch on the cable for multi-use terminal is set to “TV”. Set to “CAMERA” (page 67).

---

### Your computer does not recognize your camera.

- Turn on the camera (→ *step 2 in “Read This First”*).
- When the battery level is low, install the charged battery pack (→ *step 1 in “Read This First”*), or use the AC Adaptor (page 18).
- Use the cable for multi-use terminal (supplied) (page 67).
- Disconnect the cable for multi-use terminal from both the computer and the camera, and connect it again firmly. Make sure that “USB Mode Mass Storage” is displayed (page 67).
- Set [USB Connect] to [Mass Storage] in the  (Setup) menu (page 61).
- Disconnect all equipment other than the camera, the keyboard and the mouse from the USB connectors of your computer.
- Connect the camera directly to your computer without passing through a USB hub or other device (page 67).
- The software (supplied) is not installed. Install the software (page 65).
- Your computer does not properly recognize the device because you connected the camera and your computer with the cable for multi-use terminal before you install the software (supplied). Delete the erroneously recognized device from your computer, then install the USB driver (see the next item).

---

### The “Removable disk” icon does not appear on the computer screen when you connect your computer to the camera.

- Follow the procedure below to install the USB driver again. The following procedure is for a Windows computer.
  - 1 Right-click [My Computer] to display the menu, then click [Properties].  
The “System Properties” screen appears.
  - 2 Click [Hardware] → [Device Manager].
    - For Windows Me, click the [Device Manager] tab.  
The “Device Manager” appears.
  - 3 Right-click [ Sony DSC], then click [Uninstall] → [OK].  
The device is deleted.
  - 4 Install the software (page 65).  
A USB driver is also installed.

---

### **You cannot copy images.**

- Connect the camera and your computer correctly making a USB connection (page 67).
- Follow the designated copy procedure for your OS (pages 67, 78).
- When you shoot images with a “Memory Stick Duo” formatted by a computer, you may not be able to copy the images to a computer. Shoot using a “Memory Stick Duo” formatted by your camera (page 57).

---

### **After making a USB connection, “Cyber-shot Viewer” does not start automatically.**

- Start “Media Check Tool” (page 73).
- Make the USB connection after the computer is turned on (page 67).

---

### **The image cannot be played back on a computer.**

- If you are using “Cyber-shot Viewer,” refer to the Help.
- Consult the computer or software manufacturer.

---

### **The image and sound are interrupted by noise when you view a movie on a computer.**

- You are playing back the movie directly from the internal memory or the “Memory Stick Duo”. Copy the movie to the hard disk of your computer, then play back the movie from the hard disk (page 66).

---

### **You cannot print an image.**

- Check the printer settings.

---

### **Images once copied to a computer cannot be viewed on the camera.**

- Copy them to a folder recognized by the camera, such as “101MSDCF” (page 71).
- Operate correctly (page 72).

## **Cyber-shot Viewer**

---

### **Images are not displayed correctly with “Cyber-shot Viewer”.**

- Make sure the folder of the images is registered in “Viewed folders”. If the images are not displayed even if the folder is registered in “Viewed folders”, update the database (page 76).

---

### **You cannot find images imported with “Cyber-shot Viewer”.**

- Look in the “My Pictures” folder.
- If you have changed the default settings, refer to “Changing the “Folder to be imported”” on page 76 and check what folder is used for importing.



---

**You want to change the “Folder to be imported”.**

- Access the “Import Settings” screen to change “Folder to be imported”. You can specify a different folder after using “Cyber-shot Viewer” to register it in “Viewed folders” (page 76).

---

**All imported images are displayed on the calendar with the date January 1.**

- The date has not been set on the camera. Set the date on the camera (→ *step 2 in “Read This First”*).

**“Memory Stick Duo”****Cannot insert a “Memory Stick Duo”.**

- Insert it in the correct direction (→ *step 3 in “Read This First”*).

---

**Cannot record on a “Memory Stick Duo”.**

- You are using the “Memory Stick Duo” with the write-protect switch, and the switch is set to the LOCK position. Set the switch to the recording position (page 104).
- The “Memory Stick Duo” is full. Delete unnecessary images (→ *step 6 in “Read This First”*).
- Insert a “Memory Stick PRO Duo” (page 24) when recording movies with the image size set to [640(Fine)].

---

**Cannot format a “Memory Stick Duo”.**

- You are using the “Memory Stick Duo” with the write-protect switch, and the switch is set to the LOCK position. Set the switch to the recording position (page 104).

---

**You have formatted a “Memory Stick Duo” by mistake.**

- All the data on the “Memory Stick Duo” is deleted by formatting. You cannot restore it. We recommend that you set the write-protect switch on the “Memory Stick Duo” to the LOCK position to prevent accidental erasure (page 104).

---

**“Memory Stick PRO Duo” is not recognized by a computer with a “Memory Stick” slot.**

- Check that the computer and the card reader support “Memory Stick PRO Duo”. Users of computers and card readers made by manufacturers other than Sony should contact those manufacturers.
- If “Memory Stick PRO Duo” is not supported, connect the camera to the computer (pages 67, 78). The computer recognizes the “Memory Stick PRO Duo”.

**Internal memory****The camera or your computer cannot play back the data in the internal memory.**

- There is a “Memory Stick Duo” inserted in the camera. Remove it (→ *step 4 in “Read This First”*).

---

### Cannot record images using the internal memory.

- There is a “Memory Stick Duo” inserted in the camera. Remove it (→ *step 4 in “Read This First”*).

---

### The free capacity of the internal memory does not increase even when you copy the data stored in the internal memory to a “Memory Stick Duo”.

- The data is not deleted after copying. Execute the [Format] command (page 56) to format the internal memory after copying the data.

---

### Cannot copy the data stored in the internal memory to a “Memory Stick Duo”.

- The “Memory Stick Duo” is full. Check the capacity (64 MB or more recommended).

---

### Cannot copy the data on the “Memory Stick Duo” or the computer to the internal memory.

- Data on a “Memory Stick Duo” or a computer cannot be copied to the internal memory.

## Printing

Also see “PictBridge compliant printer” (as follows) in conjunction with the following items.

---

### Images are printed with both edges cut off.

- When you print an image shot with the image size set to [16:9], both edges of the image may be cut off.
- When printing images using your own printer, try canceling the trimming or borderless settings. Consult the printer manufacturer as to whether the printer provides these functions or not.
- When having images printed at a digital print shop, ask the shop whether they can print the images without cutting off both edges.

## PictBridge compliant printer

### A connection cannot be established.

- The camera cannot be connected directly to a printer that is not compliant with the PictBridge standard. Consult the printer manufacturer as to whether the printer is compliant with PictBridge or not.
- Check that the printer is turned on and can be connected to the camera.
- Set [USB Connect] to [PictBridge] in the  (Setup) menu (page 61).
- Disconnect and connect the cable for multi-use terminal again. If an error message is indicated on the printer, refer to the operating instructions supplied with the printer.

---

### Nothing appears on the camera screen when a USB connection is made.

- The switch on the cable for multi-use terminal is set to “TV”. Set to “CAMERA” (page 82).

---

**Cannot print images.**

- Check that the camera and the printer are properly connected using the cable for multi-use terminal.
- Turn on the printer. For further information, refer to the operating instructions supplied with the printer.
- If you select [Exit] during printing, images may not be printed. Disconnect and connect the cable for multi-use terminal again. If you still cannot print your images, disconnect the cable for multi-use terminal, turn the printer off and then on, then connect the cable for multi-use terminal again.
- Movies cannot be printed.
- Images shot using cameras other than this camera or images modified with a computer may not be printed.

---

**Printing is canceled.**

- You disconnected the cable for multi-use terminal before the  (PictBridge Connecting) mark disappears.

---

**Cannot insert the date or print images in the index mode.**

- The printer does not provide these functions. Consult the printer manufacturer as to whether the printer provides these functions or not.
- The date may not be inserted in the index mode depending on the printer. Consult the printer manufacturer.

---

**“---- -- --” is printed on the date-inserted part of the image.**

- Images that do not have the recording data cannot be printed with the date inserted. Set [Date] to [Off] and print the image again (page 83).

---

**Cannot select the print size.**

- Consult the printer manufacturer as to whether the printer can provide the desired size.

---

**Cannot print the image at the size selected.**

- Disconnect the cable for multi-use terminal and reconnect it whenever you change the paper size after the printer has been connected to the camera.
- The print setting of the camera differs from that of the printer. Change the setting of either the camera (page 83) or the printer.

---

**Cannot operate the camera after canceling printing.**

- Wait for a while as the printer is carrying out the cancellation. It may take some time depending on the printer.

## Others

### **Your camera does not work.**

- Use the type of battery pack you can use with this camera (page 106).
  - The battery level is low (The  indicator appears). Charge the battery pack (→ *step 1 in "Read This First"*).
- 

### **The power is on, but the camera does not work.**

- The built-in microcomputer is not working properly. Remove the battery pack, and then, after one minute, insert the battery pack and turn on the camera.
- 

### **Cannot identify an indicator on the screen.**

- See page 19.
- 

### **The lens gets fogged.**

- Moisture condensation has occurred. Turn off the camera and leave it for about an hour before using it (page 108).
- 

### **The camera becomes warm when you use it for a long time.**

- This is not a malfunction.
- 

### **The Clock Set screen appears when you turn on the camera.**

- Set the date and time again (→ *step 2 in "Read This First"*).

# Warning indicators and messages

## Self-diagnosis display

If a code starting with a letter of the alphabet appears, your camera has a self-diagnosis display. The last two digits (indicated by □□) will differ depending on the state of the camera.

If you are unable to solve the problem even after trying the following corrective actions a few times, your camera may need repair. Contact your Sony dealer or local authorized Sony service facility.

### C:32:□□

- There is trouble with your camera's hardware. Turn the power off and on again.

### C:13:□□

- The camera cannot read or write data on the "Memory Stick Duo". Try turning off and on the camera again, or taking out and inserting the "Memory Stick Duo" several times.
- The internal memory has experienced a format error, or an unformatted "Memory Stick Duo" is inserted. Format the internal memory or the "Memory Stick Duo" (page 57).
- The inserted "Memory Stick Duo" cannot be used with your camera, or the data is damaged. Insert a new "Memory Stick Duo" (page 104).

### E:61:□□

### E:62:□□

### E:91:□□

- A camera malfunction has occurred. Initialize the camera (page 60), then turn the power on again.

## Messages

If the following messages appear, follow the instructions.



- The battery level is low. Charge the battery pack immediately (→ *step 1 in "Read This First"*). Depending on the conditions of use or the type of battery pack, the indicator may flash even though there are still 5 to 10 minutes of remaining battery time left.

### For "InfoLITHIUM" battery only

- This battery pack is not a "InfoLITHIUM" type.

### System error

- Turn the power off and then on again (→ *step 2 in "Read This First"*).

### Internal memory error

- Turn the power off and then on again (→ *step 2 in "Read This First"*).

### Reinsert the Memory Stick

- Insert the "Memory Stick Duo" correctly.
- The inserted "Memory Stick Duo" cannot be used in your camera (page 104).
- The "Memory Stick Duo" is damaged.
- The terminal section of the "Memory Stick Duo" is dirty.

### Memory Stick type error

- The inserted "Memory Stick Duo" cannot be used in your camera (page 104).

### Format error

- Format the media again (pages 56 and 57).

---

### Memory Stick locked

- You are using the “Memory Stick Duo” with the write-protect switch, and the switch is set to the LOCK position. Set the switch to the recording position (page 104).

---

### No memory space in internal memory

#### No memory space in Memory Stick

- Delete unnecessary images or files (→ *step 6 in “Read This First”*).

---

### Read only memory

- Your camera cannot record or delete images on this “Memory Stick Duo”.

---

### No file

- No images have been recorded in the internal memory.

---

### No file in this folder

- No images have been recorded in this folder.
- You did not operate correctly when copying images from your computer (page 72).

---

### Folder error

- A folder with the same first three digit number already exists on the “Memory Stick Duo” (for example: 123MSDCF and 123ABCDE). Select another folders, or create a new folder (page 57).

---

### Cannot create more folders

- The folder with a name beginning with “999” exists on the “Memory Stick Duo”. You cannot create any folders if this is the case.

---

### Cannot record

- The camera cannot record images in the selected folder. Select a different folder (page 58).

---

### File error

- An error occurred while the image was playing back.

---

### File protect

- Release the protection (page 47).

---

### Image size over

- You are playing back an image of a size that cannot be played back on your camera.

---

### Cannot divide

- The movie is not long enough to be divided (shorter than about two seconds).
- The file is not a movie.

---

### Invalid operation

- You are trying to play back a file that is not compatible with the camera.



### (Vibration warning indicator)

- Camera shake may occur due to insufficient light. Use the flash, turn on the anti-blur function, or mount the camera on a tripod to secure the camera.

---

### 640(Fine) is not available

- 640(Fine) size movies can be recorded only using a “Memory Stick PRO Duo”. Insert a “Memory Stick PRO Duo” or set the image size to a size other than [640(Fine)].

---

### Enable printer to connect

- [USB Connect] is set to [PictBridge], however the camera is connected to a non-PictBridge compliant device. Check the device.
- The connection is not established. Disconnect and connect the cable for multi-use terminal again. If an error message is indicated on the printer, refer to the operating instructions supplied with the printer.

---

### Connect to PictBridge device

- You tried to print images before the printer connection was established. Connect to a PictBridge compliant printer.

---

### No printable image

- You tried to execute [DPOF image] without placing a DPOF (Print order) mark on the image(s).
- You tried to execute [All In This Folder] while a folder that holds only movies was selected. You cannot print movies.

---

### Printer busy

#### Paper error

#### No Paper

#### Ink error

#### Low Ink

#### No Ink

- Check the printer.

---

### Printer error

- Check the printer.
- Check if the image you want to print is corrupted.



- The data transmission to the printer may not be completed yet. Do not disconnect the cable for multi-use terminal.

---

### Processing

- The printer is canceling the current print job. You cannot print until it is finished. This may take time, depending on the printer.

---

### No image for Slide Show

- The selected folder does not contain a file that can be played in a Slide Show with music.

---

### Music Error

- Delete the Music file, or replace it with a normal Music file.
- Execute [Format Music], then download a new Music files (page 59).

---

### Format Music Error

- Execute [Format Music] (page 59).



# On the “Memory Stick”

A “Memory Stick” is a compact, portable IC recording medium. The types of “Memory Stick” that can be used with this camera are listed in the table below. However, proper operation cannot be guaranteed for all “Memory Stick” functions.

| “Memory Stick” type                     | Recording/<br>Playback |
|---|------------------------|
| Memory Stick<br>(without MagicGate)     | —                      |
| Memory Stick<br>(with MagicGate)        | —                      |
| Memory Stick Duo<br>(without MagicGate) | ○                      |
| Memory Stick Duo<br>(with MagicGate)    | ○*1*2                  |
| MagicGate Memory Stick                  | —                      |
| MagicGate Memory Stick<br>Duo           | ○*1                    |
| Memory Stick PRO                        | —                      |
| Memory Stick PRO Duo                    | ○*1*2*3                |

\*1 “Memory Stick Duo”, “MagicGate Memory Stick Duo” and “Memory Stick PRO Duo” are equipped with MagicGate functions. MagicGate is copyright protection technology that uses encryption technology. Data recording/playback that requires MagicGate functions cannot be performed with this camera.

\*2 Supports high-speed data transfer using a parallel interface.

\*3 640(Fine) size movies can be recorded.

- A “Memory Stick Duo” formatted with a computer is not guaranteed to operate with this camera.
- Data read/write speeds differ depending on the combination of the “Memory Stick Duo” and the equipment used.

## Notes on using a “Memory Stick Duo” (not supplied)

- You cannot record, edit or delete images if you slide the write-protect switch to LOCK with a fine-tipped object.

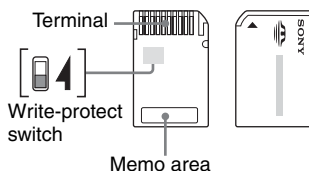

The position and/or the shape of the write-protect switch may differ depending on the “Memory Stick Duo” you use.

- Do not remove the “Memory Stick Duo” while reading or writing data.
- Data may be corrupted in the following cases:
  - When the “Memory Stick Duo” is removed or the camera is turned off during a read or write operation
  - When the “Memory Stick Duo” is used in locations subject to static electricity or electrical noise
- We recommend backing up important data.
- Do not press down hard when you write down on the memo area.
- Do not attach a label on the “Memory Stick Duo” itself nor on a Memory Stick Duo Adaptor.
- When you carry or store the “Memory Stick Duo”, put it in the case supplied with it.
- Do not touch the terminal section of the “Memory Stick Duo” with your hand or a metal object.
- Do not strike, bend or drop the “Memory Stick Duo”.
- Do not disassemble or modify the “Memory Stick Duo”.
- Do not expose the “Memory Stick Duo” to water.
- Do not leave the “Memory Stick Duo” within the reach of small children. They might accidentally swallow it.



- Do not use or store the “Memory Stick Duo” under the following conditions:
  - High temperature locations such as the hot interior of a car parked in direct sunlight
  - Locations exposed to direct sunlight
  - Humid locations or locations with corrosive substances present

### **Notes on using the Memory Stick Duo Adaptor (not supplied)**

- To use a “Memory Stick Duo” with a “Memory Stick” compliant device, be sure to insert the “Memory Stick Duo” into a Memory Stick Duo Adaptor. If you insert a “Memory Stick Duo” into a “Memory Stick” compliant device without a Memory Stick Duo Adaptor, you might not be able to remove it from the device.
- When inserting a “Memory Stick Duo” into a Memory Stick Duo Adaptor, make sure the “Memory Stick Duo” is inserted facing in the correct direction, then insert it all the way in. Incorrect insertion may result in a malfunction.
- When using a “Memory Stick Duo” inserted into a Memory Stick Duo Adaptor with a “Memory Stick” compliant device, make sure that the “Memory Stick Duo” is inserted facing the correct direction. Note that improper use may damage the equipment.
- Do not insert a Memory Stick Duo Adaptor into a “Memory Stick” compliant device without a “Memory Stick Duo” attached. Doing so may result in malfunction of the unit.

### **Notes on using “Memory Stick PRO Duo” (not supplied)**

“Memory Stick PRO Duo” with a capacity up to 2 GB have been confirmed to operate properly with this camera.

# On the “InfoLITHIUM” battery pack

This camera requires an “InfoLITHIUM” battery pack (R type).



## What is an “InfoLITHIUM” battery pack?

An “InfoLITHIUM” battery pack is a lithium-ion battery pack that has functions for exchanging information related to operating conditions with your camera. The “InfoLITHIUM” battery pack calculates the power consumption according to the operating conditions of your camera, and displays the remaining battery time in minutes.

## On charging the battery pack

We recommend charging the battery pack in an ambient temperature of between 10°C to 30°C (50°F to 86°F). You may not be able to efficiently charge the battery pack outside of this temperature range.

## Effective use of the battery pack

- Battery performance decreases in low temperature surroundings. So, the time that the battery pack can be used is shorter in cold places. We recommend the following to ensure longer battery pack use:
  - Put the battery pack in a pocket close to your body to warm it up, and insert it in your camera immediately before you start shooting.
- The battery pack will run out quickly if you use the flash or zoom frequently.
- We recommend having spare battery packs handy for two or three times the expected shooting time, and making trial shots before taking the actual shots.
- Do not expose the battery pack to water. The battery pack is not water-resistant.
- Do not leave the battery pack in extremely hot places, such as in a car or under direct sunlight.

## On the remaining battery time indicator

The power may go off although the battery remaining indicator shows there is enough power to operate. Use the battery pack up and charge the battery pack fully again so that the indication on the battery remaining indicator is correct. Note, however, that the correct battery indication sometimes will not be restored if the battery pack is used in high temperatures for a long time, left in a fully charged state or used frequently.

## How to store the battery pack

- If the battery pack is not to be used for a long time, fully charge it and then fully use it up once a year on your camera before storing the battery pack in a dry, cool place. Repeat this charging and using up once a year to maintain the battery pack's function.
- To use the battery pack up, leave your camera in slide show (page 30) playback mode until the power goes off.
- To prevent staining the terminal, short-circuiting, etc., be sure to use a supplied battery case when carrying and storing.

## On battery life

- The battery life is limited. Battery capacity decreases little by little as you use it more and more, and as time passes. If the battery operating time seems shortened considerably, a probable cause is that the battery pack has reached the end of its life. Buy a new battery pack.
- The battery life varies according to how it is stored and the operating conditions and environment in which each battery pack is used.

# On the battery charger

## ■ On the battery charger

- Do not charge any other battery pack except Sony "InfoLITHIUM" battery packs in the battery charger supplied with your camera. Batteries other than the specified kind may leak, overheat, or explode if you attempt to charge them, posing a risk of injury from electrocution and burns.
- Remove the charged battery pack from the battery charger. If you leave the charged battery pack in the charger, battery life may be shortened.
- When the CHARGE lamp flashes, this may indicate a battery error or that a battery pack other than the specified type have been inserted. Check that the battery pack is the specified type. If the battery pack is the specified type, remove the battery pack, replace it with new one or another one and check if the battery charger operates correctly. If the battery charger operates correctly, a battery error may have occurred.
- If the battery charger is dirty, charging may not be performed successfully. Clean the battery charger with dry cloth, etc.

# Precautions

## ■ Do not use/store the camera in the following places

- In an extremely hot, dry or humid place  
In places such as in a car parked in the sun, the camera body may become deformed and this may cause a malfunction.
- Under direct sunlight or near a heater  
The camera body may become discolored or deformed, and this may cause a malfunction.
- In a location subject to rocking vibration
- Near strong magnetic place
- In sandy or dusty places  
Be careful not to let sand or dust get into the camera. This may cause the camera to malfunction, and in some cases this malfunction cannot be repaired.

## ■ On carrying

Do not sit down in a chair or other place with the camera in the back pocket of your trousers or skirt, as this may cause malfunction or damage the camera.

## ■ On cleaning

### Cleaning the LCD screen

Wipe the screen surface with an LCD cleaning kit (not supplied) to remove fingerprints, dust, etc.

### Cleaning the lens

Wipe the lens with a soft cloth to remove fingerprints, dust, etc.

### Cleaning the camera surface

Clean the camera surface with a soft cloth slightly moistened with water, then wipe the surface with a dry cloth. Do not use the following as they may damage the finish or the casing.

- Chemical products such as thinner, benzene, alcohol, disposable cloths, insect repellent, sunscreen or insecticide, etc.
- Do not touch the camera with the above on your hand.
- Do not leave the camera in contact with rubber or vinyl for a long time.

## ■ On operating temperatures

Your camera is designed for use under the temperatures between 0°C and 40°C (32°F and 104°F). Shooting in extremely cold or hot places that exceed this range is not recommended.

## ■ On moisture condensation

If the camera is brought directly from a cold to a warm location, moisture may condense inside or outside the camera. This moisture condensation may cause a malfunction of the camera.

### Moisture condensation occurs easily when:

- The camera is brought from a cold location such as a ski slope into a warmly heated room.
- The camera is taken from an air-conditioned room or car interior to the hot outdoors, etc.

### How to prevent moisture condensation

When bringing the camera from a cold place to a warm place, seal the camera in a plastic bag and allow it to adapt to conditions at the new location over about an hour.

### If moisture condensation occurs

Turn off the camera and wait about an hour for the moisture to evaporate. Note that if you attempt to shoot with moisture remaining inside the lens, you will be unable to record clear images.

## ■ On the internal rechargeable battery

This camera has an internal rechargeable battery for maintaining the date and time and other settings regardless of whether the power is on or off.

This rechargeable battery is continually charged as long as you are using the camera. However, if you use the camera for only short periods, it discharges gradually, and if you do not use the camera at all for about one month it becomes completely discharged. In this case, be sure to charge this rechargeable battery before using the camera.

However, even if this rechargeable battery is not charged, you can still use the camera as long as you do not record the date and time.

### **Charging method of the internal rechargeable battery**

Insert charged battery pack in the camera, or connect the camera to a wall outlet (wall socket) using the AC Adaptor (not supplied), and leave the camera for 24 hours or more with the power off.

### **Charging method of the “InfoLITHIUM” battery pack**

→ *step 1 in “Read This First”*

# Specifications

## Camera

### [System]

|                                  |  |
|----------------------------------|--|
| Image device                     | 7.20 mm (1/2.5 type) color CCD, Primary color filter   |
| Total pixel number of camera     | Approx. 7 410 000 pixels   |
| Effective pixel number of camera | Approx. 7 201 000 pixels   |
| Lens                             | Carl Zeiss Vario-Tessar<br>3x zoom lens<br>f = 6.33 – 19.0 mm (38 – 114 mm when converted to a 35 mm still camera)<br>F3.5 – 4.3           |
| Exposure control                 | Automatic exposure, Scene Selection (9 modes)  |
| White balance                    | Automatic, Daylight, Cloudy, Fluorescent, Incandescent, Flash  |
| File format (DCF compliant)      | Still images: Exif Ver. 2.21<br>JPEG compliant, DPOF compatible<br>Movies: MPEG1 compliant (Monaural)                                      |
| Recording media                  | Internal Memory (58 MB)<br>“Memory Stick Duo”  |
| Flash                            | Recommended distance (ISO set to Auto): approx. 0.1 to 3.4 m (4 to 133 7/8 inches) (W)/approx. 0.25 to 2.7 m (9 7/8 to 106 3/8 inches) (T) |

### [Input and Output connectors]

Multi connector

USB communication

Hi-Speed USB (USB 2.0 compliant)

### [LCD screen]

|                      |                             |
|----------------------|-----------------------------|
| LCD panel            | 7.5 cm (3.0 type) TFT drive |
| Total number of dots | 230 400 (960x240) dots      |

### [Power, general]

|                                     |   |
|-------------------------------------|---|
| Power                               | Rechargeable battery pack NP-FR1, 3.6 V<br>AC-LS5K AC Adaptor (not supplied), 4.2 V |
| Power consumption (during shooting) | 1.1 W   |
| Operating temperature               | 0 to 40°C (32 to 104°F)   |
| Storage temperature                 | -20 to +60°C (-4 to +140°F)   |
| Dimensions                          | 95x56.5x23.3 mm<br>(3 3/4x2 1/4x15/16 inches)<br>(W/H/D, excluding protrusions)     |
| Mass                                | Approx. 169 g (6.0 oz)<br>(including NP-FR1 battery pack and wrist strap, etc.)     |
| Microphone                          | Electret condenser microphone   |
| Speaker                             | Dynamic speaker   |
| Exif Print                          | Compatible  |
| PRINT Image Matching III            | Compatible  |
| PictBridge                          | Compatible  |

## **BC-CS3 battery charger**

### Power requirements

AC 100 to 240 V, 50/60 Hz,  
3.2 W

Output voltage DC 4.2 V, 500 mA

### Operating temperature

0 to 40°C (32 to 104°F)

### Storage temperature

-20 to +60°C (-4 to +140°F)

### Dimensions

Approx. 66×23×91 mm  
(2 5/8×29/32×3 5/8 inches)  
(W/H/D)

### Mass

Approx. 70 g (2.7 oz)

## **Rechargeable battery pack NP-FR1**

Used battery Lithium-ion battery

### Maximum voltage

DC 4.2 V

Nominal voltage DC 3.6 V

Capacity 4.4 Wh (1 220 mAh)

Design and specifications are subject to change without notice.

## A

- AC Adaptor..... 18
  - *step 1 in "Read This First"*
- Accessories supplied
  - *in "Read This First"*
- Adjusting EV..... 37
- AE/AF lock indicator ..... 39
  - *step 5 in "Read This First"*
- AF Illuminator..... 54
- AF lock..... 39
- AF Mode..... 52
- AF range finder frame ..... 38
- AF range finder frame indicator..... 38
- Aperture..... 14
- Auto adjustment mode
  - *step 5 in "Read This First"*
- Auto Focus..... 13
- Auto power-off function
  - *step 2 in "Read This First"*
- Auto Review ..... 54

## B

- B&W ..... 36
- Battery charger ..... 107
  - *step 1 in "Read This First"*
- Battery pack
  - Battery life..... 27
  - Charging
    - *step 1 in "Read This First"*
  - Install/Remove
    - *step 1 in "Read This First"*
  - Remaining indicator
    - *step 1 in "Read This First"*

- Beach mode
  - *step 5 in "Read This First"*
- Beep ..... 59
  - *step 5 in "Read This First"*
- Blur ..... 13
- Bracket Step..... 43
- Burst..... 42

## C

- Cable for multi-use terminal..... 67, 82, 87
- Camera 1 ..... 52
- Camera 2 ..... 55
- Center AF..... 38
- Center-weighted metering.... 40
- Change REC. Folder ..... 58
- Charging battery pack
  - *step 1 in "Read This First"*
- Cleaning ..... 108
- Clock Set..... 62
- Cloudy..... 40
- Color ..... 15
- Color Mode..... 36
- Compression ratio ..... 16
- Computer ..... 63
  - Copying images ..... 66, 78
  - Macintosh ..... 78
  - Recommended environment ..... 64, 78
  - Software..... 65, 73, 77
  - Viewing image files stored on a computer with your camera..... 72
  - Windows ..... 63
- Connecting
  - Computer ..... 67
  - Printer ..... 82
  - TV ..... 87
- Contrast..... 44

- Copy ..... 58
- Copying images to your computer ..... 66
- Create REC. Folder ..... 57
- Cyber-shot Viewer..... 73

## D

- Daylight..... 40
- DC IN jack ..... 18
- Delete
  - Format ..... 56, 57
  - *step 6 in "Read This First"*
- Digital Zoom ..... 52
- DirectX ..... 64
- Divide ..... 48
- DPOF..... 85

## E

- Effective pixels ..... 110
- Electronic transformer
  - *step 1 in "Read This First"*
- EV..... 37
- Exposure..... 14
- Exposure Bracket ..... 42
- Extension ..... 71, 72

## F

- File name ..... 71
- File Number..... 61
- File storage destination..... 71
- Fine..... 41
- Fireworks mode
  - *step 5 in "Read This First"*
- Flash ..... 40
- Flash forced off
  - *step 5 in "Read This First"*
- Flash forced on
  - *step 5 in "Read This First"*



|  |              |
|--|--------------|
| Flash Level.....                                       | 44           |
| Flash mode   |              |
| → <i>step 5 in "Read This First"</i>                   |              |
| Fluorescent.....                                       | 40           |
| Focus.....   | 13, 38       |
| Focus preset .....                                     | 38           |
| Folder.....  | 45           |
| Changing .....   | 58           |
| Creating .....   | 57           |
| Format.....  | 56, 57       |
| Function Guide .....                                   | 53           |
| <b>H</b>   |              |
| High sensitivity mode                                  |              |
| → <i>step 5 in "Read This First"</i>                   |              |
| High-speed shutter mode                                |              |
| → <i>step 5 in "Read This First"</i>                   |              |
| Histogram .....  | 23, 37       |
| Holding the camera                                     |              |
| → <i>step 5 in "Read This First"</i>                   |              |
| <b>I</b>   |              |
| Identifying parts.....                                 | 17           |
| Image file storage destinations<br>and file names..... | 71           |
| Image quality .....                                    | 15, 41       |
| Image size .....                                       | 15           |
| → <i>step 4 in "Read This First"</i>                   |              |
| Incandescent .....                                     | 40           |
| Index mode printing.....                               | 81           |
| Index screen   |              |
| → <i>step 6 in "Read This First"</i>                   |              |
| Indicator.....   | see "Screen" |
| "InfoLITHIUM"  |              |
| battery pack .....                                     | 106          |
| Initialize .....                                       | 60           |
| Install .....  | 65           |

|  |        |
|--|--------|
| Internal memory .....                  | 25     |
| Internal Memory Tool .....             | 56     |
| Internal rechargeable<br>battery ..... | 109    |
| Interval .....                         | 43     |
| ISO .....                              | 14, 41 |

## J

|          |    |
|----------|----|
| JPG..... | 71 |
|----------|----|

## L

|                                      |              |
|--------------------------------------|--------------|
| Landscape mode                       |              |
| → <i>step 5 in "Read This First"</i> |              |
| Language.....                        | 59           |
| → <i>step 2 in "Read This First"</i> |              |
| LCD Backlight .....                  | 59           |
| LCD Screen.....                      | see "Screen" |

## M

|                                      |     |
|--------------------------------------|-----|
| M AF.....                            | 52  |
| Macintosh computer.....              | 78  |
| Recommended<br>environment .....     | 78  |
| Macro                                |     |
| → <i>step 5 in "Read This First"</i> |     |
| Magnifying Glass                     |     |
| → <i>step 5 in "Read This First"</i> |     |
| Mass Storage .....                   | 61  |
| "Memory Stick Duo" .....             | 104 |

|  |     |
|--|-----|
| Insert/Remove                              |     |
| → <i>step 3 and 4 in "Read This First"</i> |     |
| Number of images/<br>recording time .....  | 24  |
| Write-protect switch ...                   | 104 |
| Memory Stick Tool .....                    | 57  |

|                             |        |
|-----------------------------|--------|
| Menu.....                   | 33     |
| Items .....                 | 34     |
| Shooting .....              | 36     |
| Viewing .....               | 45     |
| Metering Mode .....         | 40     |
| Mode.....                   | 42     |
| Moisture condensation.....  | 108    |
| Monitor .....               | 52     |
| MPG .....                   | 71     |
| Multi AF .....              | 38     |
| Multi Burst.....            | 42     |
| Multi connector .....       | 18     |
| Multi-pattern metering..... | 40     |
| Multipoint AF.....          | 38     |
| Music .....                 | 31     |
| Music Transfer.....         | 77, 79 |

## N

|   |    |
|---|----|
| Natural .....                           | 36 |
| NR slow shutter .....                   | 20 |
| NTSC.....                               | 62 |
| Number of images/Recording<br>time..... | 24 |

## O

|                                      |        |
|--------------------------------------|--------|
| Optical zoom .....                   | 52     |
| → <i>step 5 in "Read This First"</i> |        |
| OS.....                              | 64, 78 |
| Overexposure.....                    | 14     |

## P

|                                      |                |
|--------------------------------------|----------------|
| PAL.....                             | 62             |
| PC.....                              | see "Computer" |
| PictBridge .....                     | 61, 81         |
| Pixel.....                           | 15             |
| Playback zoom                        |                |
| → <i>step 6 in "Read This First"</i> |                |
| Playback .....                       | see "Viewing"  |
| Playback/Edit.....                   | 28             |

|                                      |     |
|--------------------------------------|-----|
| Precautions .....                    | 108 |
| Precision digital zoom .....         | 52  |
| Pressing halfway down .....          | 13  |
| → <i>step 5 in "Read This First"</i> |     |
| Print .....                          | 80  |
| Index mode .....                     | 81  |
| Single-image mode .....              | 81  |
| Print order mark .....               | 85  |
| Printing at a shop .....             | 85  |
| Printing directly .....              | 81  |
| Program auto shooting .....          | 28  |
| Protect .....                        | 46  |
| PTP .....                            | 61  |

## Q

|                                      |  |
|--------------------------------------|--|
| Quick Review                         |  |
| → <i>step 5 in "Read This First"</i> |  |

## R

|                                      |    |
|--------------------------------------|----|
| REC Mode .....                       | 42 |
| Red Eye Reduction .....              | 53 |
| Resize .....                         | 47 |
| Rewind/Fast forward                  |    |
| → <i>step 6 in "Read This First"</i> |    |
| Rotate .....                         | 48 |

## S

|                                      |     |
|--------------------------------------|-----|
| S AF .....                           | 52  |
| Scene Selection .....                | 29  |
| → <i>step 5 in "Read This First"</i> |     |
| Screen                               |     |
| Changing the display .....           | 23  |
| Indicator .....                      | 19  |
| LCD backlight .....                  | 23  |
| Self-diagnosis display .....         | 101 |
| Self-timer                           |     |
| → <i>step 5 in "Read This First"</i> |     |

|                                      |            |
|--------------------------------------|------------|
| Sepia .....                          | 36         |
| Set the clock                        |            |
| → <i>step 2 in "Read This First"</i> |            |
| Setup .....                          | 44, 50, 51 |
| Camera 1 .....                       | 52         |
| Camera 2 .....                       | 55         |
| Internal Memory Tool .....           | 56         |
| Memory Stick Tool .....              | 57         |
| Setup 1 .....                        | 59         |
| Setup 2 .....                        | 61         |
| Setup 1 .....                        | 59         |
| Setup 2 .....                        | 61         |
| Sharpness .....                      | 44         |
| Shooting                             |            |
| Movie                                |            |
| → <i>step 5 in "Read This First"</i> |            |
| Still image                          |            |
| → <i>step 5 in "Read This First"</i> |            |
| Shooting menu .....                  | 36         |
| Shooting movies                      |            |
| → <i>step 5 in "Read This First"</i> |            |
| Shutter speed .....                  | 14         |
| Single .....                         | 52         |
| Single-image mode                    |            |
| printing .....                       | 81         |
| Slide Show .....                     | 30         |
| Slow synchro                         |            |
| → <i>step 5 in "Read This First"</i> |            |
| Smart zoom .....                     | 52         |
| Snow mode                            |            |
| → <i>step 5 in "Read This First"</i> |            |
| Soft snap mode                       |            |
| → <i>step 5 in "Read This First"</i> |            |
| Software .....                       | 65, 73, 77 |
| Specifications .....                 | 110        |
| Spot AF .....                        | 38         |
| Spot metering .....                  | 40         |

|                                 |    |
|---------------------------------|----|
| Spot metering cross hairs ..... | 40 |
| Standard .....                  | 41 |
| STEADY SHOT .....               | 55 |

## T

|                                      |    |
|--------------------------------------|----|
| Trimming .....                       | 50 |
| Troubleshooting .....                | 89 |
| TV .....                             | 87 |
| Twilight mode                        |    |
| → <i>step 5 in "Read This First"</i> |    |
| Twilight portrait mode               |    |
| → <i>step 5 in "Read This First"</i> |    |

## U

|                                      |    |
|--------------------------------------|----|
| Underexposure .....                  | 14 |
| USB Connect .....                    | 61 |
| Using your camera abroad             |    |
| → <i>step 1 in "Read This First"</i> |    |

## V

|                                      |    |
|--------------------------------------|----|
| VGA                                  |    |
| → <i>step 4 in "Read This First"</i> |    |
| Video Out .....                      | 62 |
| Viewing                              |    |
| Movie                                |    |
| → <i>step 6 in "Read This First"</i> |    |
| Still image                          |    |
| → <i>step 6 in "Read This First"</i> |    |
| Viewing menu .....                   | 45 |
| Vivid .....                          | 36 |
| Volume                               |    |
| → <i>step 6 in "Read This First"</i> |    |

## W

|                                       |     |
|---------------------------------------|-----|
| Warning indicators and messages ..... | 101 |
| WB .....                              | 40  |

|  |     |
|--|-----|
| White balance .....                          | 40  |
| Windows computer .....                       | 63  |
| Recommended<br>environment .....             | 64  |
| Wrist strap<br>→ in <i>“Read This First”</i> |     |
| Write-protect switch .....                   | 104 |

## **Z**

|  |  |
|--|--|
| Zoom<br>→ step 5 in <i>“Read This<br/>    First”</i> |  |
|--|--|

## Trademarks

- **Cyber-shot** is a trademark of Sony Corporation.
- “Memory Stick”,  “Memory Stick PRO”, **MEMORY STICK PRO**, “Memory Stick Duo”, **MEMORY STICK DUO**, “Memory Stick PRO Duo”, **MEMORY STICK PRO DUO**, “MagicGate”, and **MAGIC GATE** are trademarks of Sony Corporation.
- “InfoLITHIUM” is a trademark of Sony Corporation.
- Microsoft, Windows and DirectX are either registered trademarks or trademarks of Microsoft Corporation in the United States and/or other countries.
- Macintosh, Mac OS, iMac, iBook, PowerBook, Power Mac and eMac are trademarks or registered trademarks of Apple Computer, Inc.
- Intel, MMX, and Pentium are trademarks or registered trademarks of Intel Corporation.
- In addition, system and product names used in this manual are, in general, trademarks or registered trademarks of their respective developers or manufacturers. However, the <sup>TM</sup> or © marks are not used in all cases in this manual.





