

1 Getting started

This Quick Start Guide has been designed to aid in quickly getting started with mounting and using the accessories obtained. If you require further help, or have further questions on the detail in how to operate the projector unit or to see the selection of accessories available, please refer to the projector user guide or our web site. You can also access FAQs, and download detailed white papers in order to get to know the more specific features and benefits.

Packaging contents for full kit (exceptions in brackets):



- 1 Air-inlet filter (not included in kit/sold separately)
 - 2 Side cover/Air-inlet
 - 3 Ceiling mount cover/Air-outlet (included in kit/also sold separately)
 - 4 Exhaust air duct (including flexible hose with clamp)
- 2/3/4 Exhaust air kit (combined) 2/3 Acoustic silencer kit (combined)



User documentation

2

Mounting Air-inlet filter / Ceiling mount cover / Exhaust air kit

The Exhaust air kit is delivered without an Air-inlet filter (1 - illustration above), but the filter can be purchased separately and added either with or without the rest of the kit. The Ceiling mount cover (3 - illustration above) is included in the Exhaust air kit, but can also be purchased separately.

Air-inlet filter (1 - illustration above): To mount the Air-inlet filter, fit the filter onto the grille and make sure the extruding plastic guide enters the inlet grille properly. Attach the Air-inlet filter to the grille using the 3 supplied screws, two long screws on the left hand side and one shorter screw on the right hand side. If part of a kit, make sure to mount the filter first. For mounting of other parts, see description in the following sections below. Mounting a filter is registered by the projector and a reminder to clean or replace the filter will appear when required.

Ceiling mount cover (no. 3 - illustration above): Attach the cover by entering the plastic guides into the fitting holes at the back of the projector (upper edge). Snap the cover onto the rear end of the projector, making sure that the 2 extensions with screw holes are positioned over the corresponding holes in the projector chassis. Fasten by entering the supplies screws. Make sure that the screws enter correctly and do not overtighten. If you have a complete kit, see exhaust duct description below first.

Exhaust duct (no. 4 - illustration above): If you have a kit, the exhaust duct needs to be mounted on the ceiling mount cover before attaching the cover to the projector. First you need to loosen the chamber wall separating the padded exhaust chamber from the rest of the cover by removing 2 screws (Section 4 - right hand side). Position the exhaust duct, angle pointing backwards, entering the slot on the cover side facing outwards. Make sure that the protruding retainer enters the back cover rim correctly when pushed backwards into place. Place the chamber wall back in initial position and fasten the 2 wall screws. Finally fasten the 2 screws connecting the wall to the exhaust duct.

Side cover (no. 2 - illustration above): In order to mount the side cover the ceiling mount cover has to be mounted first. Position the side cover so that the screw holes at the rear end of the projector fits into the countersink in the ceiling mount cover and the holes at the front end of the side cover are positioned above the corresponding holes in the projector. Enter the screws (short screws at rear end/long at front end of projector) and fasten.

Flexi-hose for exhaust duct (section 4 - right hand side): Thread the flexible hose for the exhaust air onto the exhaust duct and fasten it with the hose clamp.

A Exhaust air kit assembly without Air-inlet filter	C How the finished mounted kit should look
B Exhaust air kit assembly including Air-inlet filter	D Air flow directions for the Exhaust air kit (blue = inlet air / red = exhaust).

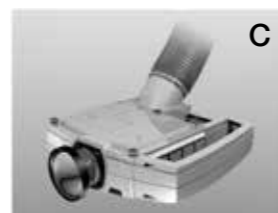
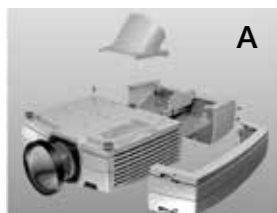

3

Important to know

When installing the exhaust air kit please notice the following:

- Make sure that the individual parts enter their locations effortlessly and that the screws are not overtightened when fastened.
- Do not block neither the air inlet nor the exhaust air outlet. Hot air is exhausted from the rear air outlet. Do not place any objects sensitive to heat near to the exhaust vent. For instance do not curl up additional cable lengths inside the ceiling mount cover (section 1/part 3).
- Minimum safety distance to the unit (with kit mounted) is 50 cm / 20" to the air inlet side: The distance to ceiling must be at least 15 cm / 6". For the other side of the projector (with no air inlet/outlet) and the top (facing down), no distance restrictions apply.
- If air-inlet filter is installed, take care to remove and clean the filter removing dust and filth at regular intervals.
- Do not mount this kit on a projector used in any other position than ceiling mounted!
- Make sure to mount the flexible hose correctly, as seen in section 4 below.

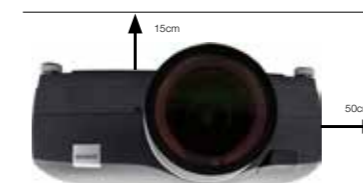

i For further information on ceiling mounting of your projector please refer the user manual or our web page

4

Mounting the flexible hose

When mounting the flexible hose on the exhaust air, please notice the following:

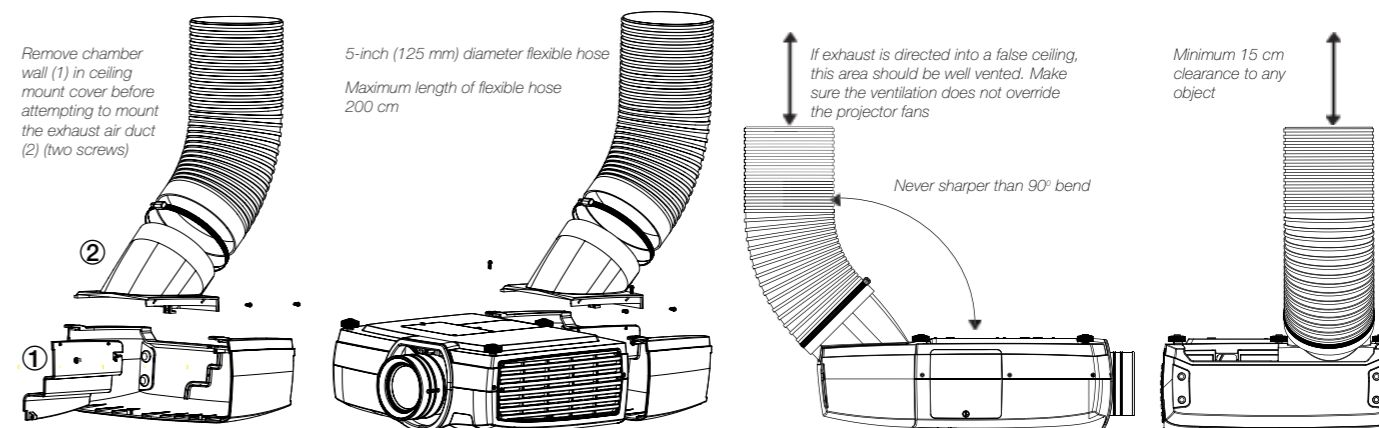

i Please notice that the exhaust air kit is only intended for ceiling mounted projectors

WEEE INFORMATION

 This product conforms to all requirements of the EU Directive on waste electrical and electronic equipment (WEEE). This product shall be recycled properly. It can be disassembled to facilitate proper recycling of its individual parts.

Consult your dealer or relevant public authority regarding drop-off points for collection of WEEE. For details, please visit the Barco website at: <http://www.barco.com/en/AboutBarco/weee>.

WEEE-ANGABEN

 Dieses Produkt erfüllt alle Auflagen aus der EU-Richtlinie für Elektro- und Elektronik-Altgeräte (WEEE). Dieses Produkt kann sachgemäß recycelt werden. Es kann zerlegt werden, um die Einzelteile ordnungsgemäß zu recyceln.

Fragen Sie Ihren Händler oder die zuständigen Behörden nach Entsorgungsstellen für Elektro- und Elektronik-Altgeräte. Für weitere Informationen, besuchen Sie bitte die Website unter: <http://www.barco.com/en/AboutBarco/weee>.

INFORMATION WEEE

 Cet appareil est conforme à la Directive EU relative au recyclage des équipements électriques et électroniques (WEEE). Cet appareil doit être recyclé correctement. Il peut être démonté pour faciliter le recyclage de chaque pièce séparément.

Consultez votre revendeur ou les autorités publiques compétentes concernant les points de collecte WEEE. Pour plus de détails, veuillez visiter le site web Barco à: <http://www.barco.com/en/AboutBarco/weee>.

INFORMACIÓN WEEE

 Este producto cumple todos los requisitos de la Directiva de la UE sobre residuos de equipos eléctricos y electrónicos. Este producto debe reciclarse adecuadamente. Puede desmontarse para facilitar el adecuado reciclado de cada una de sus piezas.

Consulte a su distribuidor o al organismo público pertinente acerca de los puntos limpios para la recogida de residuos de equipos eléctricos y electrónicos. Para obtener más información, visite la página web de Barco: <http://www.barco.com/en/AboutBarco/weee>.

INFORMAZIONI SU WEEE

 Questo dispositivo è conforme a tutti i requisiti della direttiva UE (WEEE) sullo smaltimento di apparecchiature elettriche ed elettroniche. Questo prodotto deve essere riciclato correttamente e può essere smontato per agevolare il riciclaggio dei singoli componenti.

Per informazioni sui punti di raccolta WEEE, consultare il rivenditore o l'autorità preposta. Per ulteriori informazioni, visitare il sito web Barco: <http://www.barco.com/en/AboutBarco/weee>.

WEEE INFORMATION

 Dette produktet tilfredsstiller alle krav i EU direktivet 2002/96/EC som gjelder bruk elektrisk og elektronisk utstyr. Dette produktet skal resirkuleres forsvarlig. Det kan demonteres slik at de enkelte deler kan resirkuleres forsvarlig.

Kontakt din forhandler eller relevant offentlig myndighet angående returpunkter for innsamling av WEEE. For mer informasjon, se Barco sin webside: <http://www.barco.com/en/AboutBarco/weee>.