

Welcome

*Dear user, thanks for purchasing this product.
Much investment in time and effort has gone into its development,
and it is our hope that it will give you many years of trouble-free service.*

Safety Notice

1. Do not drop, puncture or disassemble the camera; otherwise the warranty will be voided.
2. Avoid all contact with water, and dry hands before using.
3. Do not expose the camera to high temperature or leave it in direct sunlight. Doing so may damage the camera.
4. Use the camera with care. Avoid pressing hard on the camera body.
5. For your own safety, avoid using the camera when there is a storm or lightning.
6. Do not use batteries of different specifications. Doing so may lead to the potential for serious damage.
7. Remove the battery during long periods between usage, as a deteriorated battery may affect the functionality of the camera.
8. Remove the battery if it shows signs of leaking or distortion.
9. Use only the accessories supplied by the manufacturer.
10. Keep the camera out of the reach of infants.



Table of Contents

Welcome	1
Safety Notice	1
Table of Contents	2
Getting Started	4
Knowing your camera parts	4
Installing the battery	5
Using the charger	6
Inserting a memory card (optional)	7
Attaching the wrist strap (optional)	8
Basic Operations	9
Turning on your camera	9
Turning off your camera	9
Using the LCD monitor	10
Reading LCD indicators	11
Setting time and language	12
Recording a video clip	13
Taking a still picture	15
Recording a voice clip	16
Playing back your recordings	17
Playing MP3 music	18
Connecting the camera to a TV	20
Advanced Operations	21
Menu operation	21
Menu illustration	21
Menu items in Camera mode	22
Menu items in Playback mode	25
Menu items in MP3 mode	26
Menu items in Voice mode	26
Menu items in Setting mode	27
Copying Files to Your PC	29
Installing the driver to your PC	29
Connecting the camera to your PC	31
Copying files to the PC	32
Viewing/Playing files on your PC	34
File location	35

Table of Contents

Using PC Camera	36
Installing the software	36
Starting the application	36
Using IS-DV PC Camera	39
Addenda	42
Troubleshooting	42
Flicker Settings	45
Battery Life Indicator.....	45
Storage Capacity	46
System Message	47
Specifications	48

Getting Started

● Knowing your camera parts

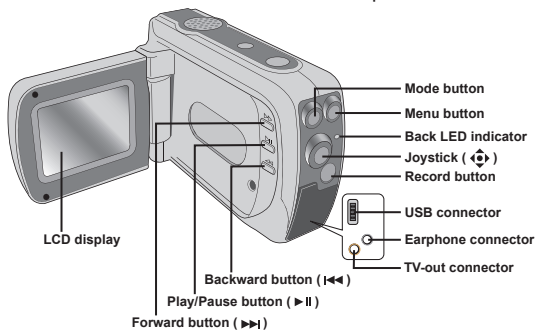
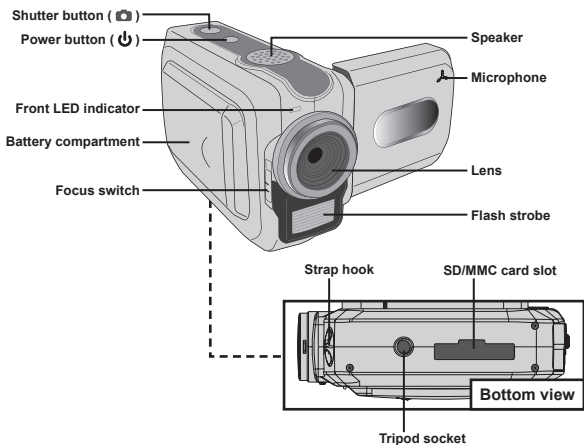

● Installing the battery

- 1 Open the battery compartment cover.**
Slide the battery compartment cover open as indicated.

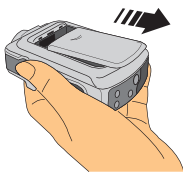

- 2 Install the battery.**
Place the accessory Li-ion battery into the compartment. Note that the metallic contacts must be aligned with the contacts in the compartment.

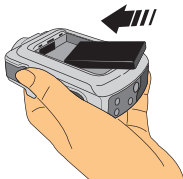

- 3 Replace the cover.**
After the battery is properly installed, replace the battery compartment cover.

- ⚠ Treat the Li-ion battery with care:
 - Keep the battery away from fire or high-temperature environment (over 140° F or 60° C).
 - Do not drop the battery or try to disassemble it.
 - If the battery is not used for long periods, fully discharge and charge the battery at least once a year to maintain its lifecycle.
- ⚠ Upon using the battery for the first time, you are recommended to fully discharge and then charge the battery to ensure its lifecycle.

● Using the charger

When the battery pack is out of power, you can use the accessory charger to recharge the battery pack.

- 1** Connect one end of the supplied AC adapter to the charger stand and the other end to a wall outlet.
-

- 2** Place the depleted battery pack into the charger.

Note that the metallic contacts must be aligned with the contacts in the charger.

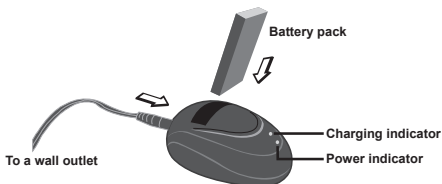

- 3** The charging indicator turns red and the charge starts.
-

- 4** When the charging indicator turns green, the battery pack is fully charged.

- ⚠ This charger can only be used to charge the accessory battery pack. Do not use it to charge other unknown batteries.
- ⚠ When in use, do not place the charger near fire or in an enclosed area that retains heat.

● Inserting a memory card (optional)

In addition to the built-in flash memory, your camera can store data on a Secure Digital (SD) card or a MultiMedia card (MMC). To insert a memory card, gently push the card as indicated until the card reaches the bottom of the slot. To remove the memory card, gently push the card and it will pop up. Then pull the card out of the slot.

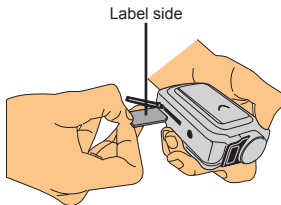

The SD card comes with a write-protect switch. When the write-protect switch is set to the Lock position, the card will become non-writable. To ensure that the camera can operate normally, you should set the write-protect switch to the Unlock position before inserting the SD card.

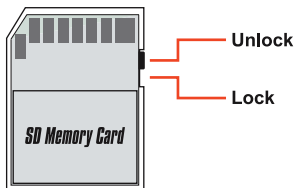

- ❗ Do not remove the memory card while the camera is processing data (when the LED is blinking).
- ❗ When a memory card is inserted, the camera will use the card as the main storage medium. Files stored in the camera's built-in memory will become inaccessible until the card is removed.

● Attaching the wrist strap (optional)

1 Attach the lens cap to the strap.

Thread the string on the side of the strap through the cap, and then thread the strap through the string loop to fasten the cap.

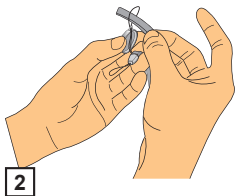
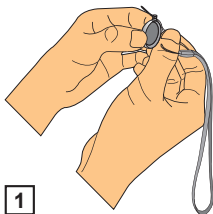

2 Attach the strap to the camera.

Thread the end of the strap through the hook on the camera, and then thread the strap through the string loop.

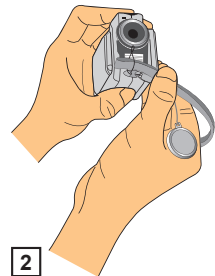
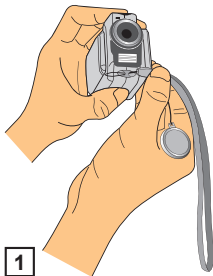

Basic Operations

● Turning on your camera

Press and hold down the power button for 1 second to turn on the camera.

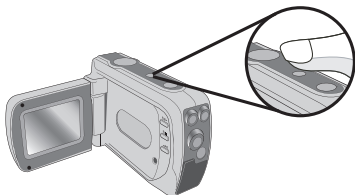

❗ If the camera is not turned on after pressing the power button, please check:

1. The battery pack is well installed in the camera.
2. The battery pack has enough power left.

● Turning off your camera

Press and hold down the power button for 1 second to turn off the camera.

OR

If the camera stays inactive for a long period of time, it may automatically shut down due to the Auto-Off setting. See page 28 for more information.

● Using the LCD monitor

The LCD monitor can be used to compose image settings for shooting, to review recorded files, or to change menu options.

The LCD panel can be rotated to the following positions:

1 Normal position.

Normally, the LCD panel is not rotated for the user to get a clear preview on the screen.

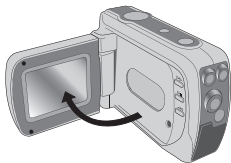

2 Rotate the LCD panel.

The LCD panel can be rotated up to 180 degrees as indicated. You can position the panel at any angle to serve your filming purpose.

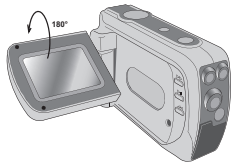

- ! When the LCD panel is flipped over, the previewed image on the LCD will be automatically adjusted.

● Reading LCD indicators

Digital Camcorder mode:

Flash mode
Selftimer

Mode icon

Video resolution

Zoom ratio

Photo resolution

White balance

Storage medium*¹

Battery Life

Number of recordings

*¹ This icon will change according to the storage medium you are using:
: internal memory.
: memory card.

Playback mode:

File type

Current / Total recordings

Mode icon

Highlight box



Image thumbnail

Battery Life

Storage medium



● Setting time and language

When you power on the camera for the first time, you are recommended to adjust the time and language settings.

- 1** Turn on the camera.
- 2** Press the Mode button and use the joystick to select the Setting () mode. Then press the center of the joystick to enter.
- 3** Use the joystick to select the Date & Time () item.
- 4** Press the joystick or move the joystick toward right to enter the sub-menu.
- 5** Move the joystick left or right to shift between items. Move the joystick up or down to adjust the value. Press the center of the joystick to confirm the setting.
- 6** After returning to the menu, use the joystick to select the Language () item.
- 7** Press the joystick or move the joystick toward right to enter the sub-menu.
- 8** Use the joystick to select a suitable language and press the center of the joystick to confirm.

● Recording a video clip

1 Adjust the focus.

Set the **Focus Switch** to an appropriate setting. Normally, you should set the focus to () for most filming conditions. Select () only for close-ups. The focus is adjustable during recording.

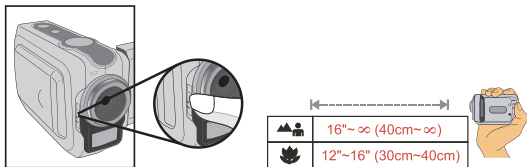

2 Use the joystick to zoom in or zoom out the screen. Adjust other settings if necessary.

For details on the white balance options, see the "Advanced Operations" section.

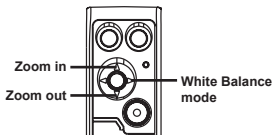

- ❗ The zoom function is also available during recording.
- ❗ Adjust other advanced settings if necessary. See the section "Advanced Operations" for more information.

● Recording a video clip (continued)

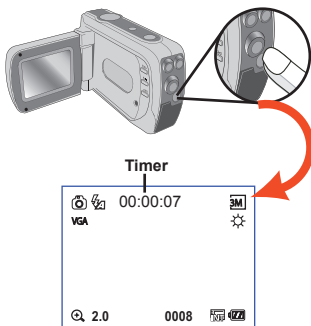

3 Press the Record button to start recording.



4 Press the Record button again to stop recording.

● Taking a still picture

1 Adjust the focus.

Set the **Focus Switch** to an appropriate setting. Normally, you should set the focus to () for most filming conditions. Select () only for close-ups.

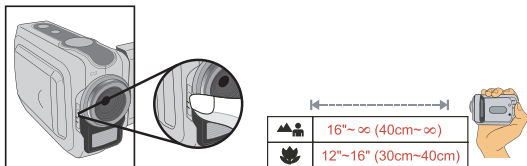

2 Use the joystick to zoom in or zoom out the screen. Adjust other settings if necessary.

For details on the flash mode and white balance options, see the "Advanced Operations" section.

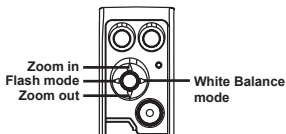

! Adjust other advanced settings if necessary. See the section "Advanced Operations" for more information.

3 Press the Shutter button to take a still picture.

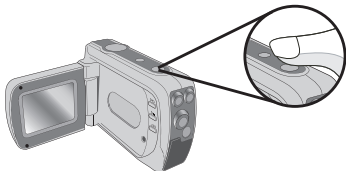

● Recording a voice clip

- 1 Press the Mode button and use the joystick to select the Voice () mode. Then press the center of the joystick to enter.
-

- 2 Press the Record button to start recording.

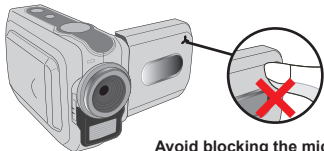

Avoid blocking the microphone



- ! Before or during recording, you can move the joystick toward left or right to adjust microphone sensibility, thus setting the sound volume of the recording.
-

- 3 When you are done, press the Record button again to stop recording.

● Playing back your recordings

- 1 Press the **Mode** button and use the joystick to select the **Playback** () mode. Then press the center of the joystick to enter.

2 Operations in playback mode:

File type	How to...	Action
-	Shift between index mode and full-screen mode	In index mode, press the center of the joystick to switch to full-screen mode. In full-screen mode, press the Menu button to switch to index mode.
-	Shift between files	1. In index mode: Use the joystick to move the highlight box. 2. In full-screen mode: Use the joystick to move left or right.
Picture ()	Zoom in/out	Use the joystick to move up or down.
	Lock/Release zoom ratio	When the zoom ratio is greater than 1.0x, press the center of the joystick.
	Browse the enlarged picture	When the zoom ratio is locked, use the joystick to browse the picture.
Video () & Audio ()	Start playing	When selected (in full-screen mode), the file automatically starts playing.
	Pause/Resume playing	During playing/While paused, press the center of the joystick.
	Adjust sound volume	During playing, use the joystick to move up or down.
	Stop playing	During playing, press the Menu button.

- ❗ When reviewing a picture, if you move the joystick down when the zoom ratio is 1.0x, the screen will switch to index mode.

● Playing MP3 music

❖ Copy MP3 files to the camera

Before you can play MP3 music, you need to copy MP3 files to the camera first.

1 **Connect the camera to your PC.**

Connect the camera to a PC using the USB cable. For details on connecting the camera to your PC, see page 31.

2 **Copy files to the camera.**

After the camera is connected to the PC, double-click on My Computer and you will find a removable disk. Create a "MP3" folder in the removable disk, and then you can copy MP3 files into the folder for playing.

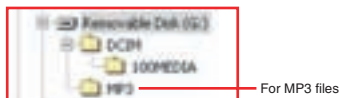

- ❗ MP3 files must be placed in the "MP3" folder for playing.
- ❗ To take advantage of the removable disk function, Windows 98SE users may need to install the accessory driver. See page 29-30 for details on the installation.

● Playing MP3 music (continued)



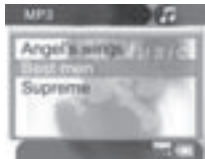

❖ Playing music in MP3 mode

- 1 Press the Mode button and use the joystick to select the MP3 () mode. Then press the center of the joystick to enter.



MP3 mode

2 Operations in MP3 mode:

How to...	Action
Shift between tracks	Use the joystick to move up or down. Or press the Forward () button or Backward () button.
Start playing	Press the center of the joystick or the Play/Pause () button.
Pause/Resume playing	During playing/While paused, press the center of the joystick or the Play/Pause () button.
Adjust sound volume	Use the joystick to move left or right.
Stop playing	During playing, press the Menu button.

● Connecting the camera to a TV

Connect your camera and TV via the accessory AV cable for real-time display. You can display your video clips, still pictures, and audio recordings directly on your TV, sharing them with your friends and family.

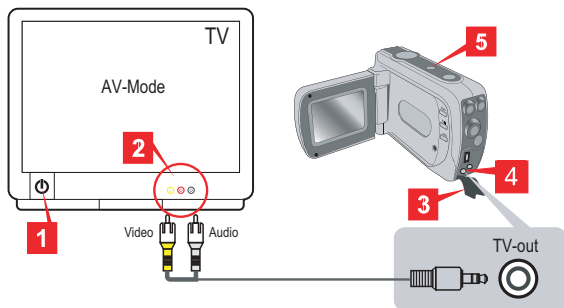

- 1 Turn on your TV and switch the TV to AV mode.
- 2 Connect the audio and video ends of the AV cable to the TV.
- 3 Open the TV-out port cover.
- 4 Connect the other end of the AV cable to your camera.
- 5 Turn on the camera.

Advanced Operations

● Menu operation

The menu items provide several options for you to fine-tune your camera functions. The following table gives details on menu operations.







How to...	Action
Bring up the menu	Press the Menu button.
Move the highlight bar	Use the joystick to move up or down.
Enter sub-menu/ Confirm an item	Press the center of the joystick.
Exit menu/Go back to upper menu	Press the Menu button (when in sub-menu).

● Menu illustration











● Menu items in Camera mode







Power-on → Press the **Menu** button.

Item	Option	Description
Resolution	 1M	Set picture resolution to 1280x960. Print up to 3x5 in. photos or display on PC.
	 3M	Set picture resolution to 2048x1536. Print 4x6 in. or 5x7 in. photos.
	 5M	Set picture resolution to 2560x1920. Print up to 6x8 in. photos.
Date Stamp	 On	Print a date mark on each picture.
	 Off	Disable date mark.
Stabilizer	 On	Minimize blur caused by hand shake.
	 Off	Disable stabilizer.

● Menu items in Camera mode (continued)



Item	Option	Description
WB	 Auto	The camera automatically adjusts white balance.
	 Sunny	This setting is suitable for outdoor recording in sunny weather.
	 Cloudy	This setting is suitable for recording in cloudy weather or shady environments.
	 Fluorescent	This setting is suitable for indoor recording with fluorescent lamp lighting, or environments with high color temperature.
	 Tungsten	This setting is suitable for indoor recording with incandescent lamp lighting, or environments with low color temperature.
 Histogram	On	Image histogram displays on the screen.
	Off	Disable histogram.
Flashlight	 Auto	The flash automatically fires when the lighting is insufficient.
	 On	The flash is forced to fire in every shot.
	 Off	The flash is disabled.

● Menu items in Camera mode (continued)

Item	Option	Description
Effect	 Normal	Make recordings in natural color.
	 B&W	Make recordings in black and white.
	 Classic	Make recordings in sepia-toned color.
 Exposure	-2~+2	Manually adjust the exposure to gain better effect when the preview image appears too bright or too dark. A positive value indicates the image will be brighter than usual; while a negative value makes the image dimmer.
Selftimer	 On	Enable the selftimer. After the selftimer is turned on, the camera will have ten seconds delay before recording when the Shutter button is pressed.
	 Off	Disable selftimer.
 Icon	On	Enable OSD (on screen display) icons to display on the screen.
	Off	Disable OSD icons.
Video	VGA VGA	Set the video resolution to VGA (640x480 pixels).
	QVGA QVGA	Set the video resolution to QVGA (320x240 pixels).

● Menu items in Playback mode

Power-on → Press the **Mode** button → Enter the Playback () mode → Press the **Menu** button.

Item	Option	Description
 Delete	One	Delete current file.
	All	Delete all pictures and video/audio files stored in the memory.
	Cancel	Cancel action.
 Slide Show	-	The camera displays images in sequence. Only JPEG pictures and the first frames of MPEG files will be displayed. You can press the Enter button to stop the slide show.
 Print	One	Print current image when connected with a PictBridge-ready printer.
	All	Print all images when connected with a PictBridge-ready printer.
	Cancel	Cancel action.

- ! Before using the Print command in the menu, you need to connect the camera to a PictBridge compatible printer via the accessory USB cable. Consult the user guide of the printer for details on operations.

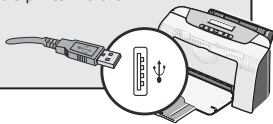

● Menu items in MP3 mode

Power-on → Press the **Mode** button → Enter the MP3 () mode → Press the **Menu** button.

Item	Description
Delete One	Delete current track.
Cancel	Cancel action.











● Menu items in Voice mode

Power-on → Press the **Mode** button → Enter the Voice () mode → Press the **Menu** button.







Item	Description
Delete One	Delete current voice recording.
Delete All	Delete all voice recordings.

● Menu items in Setting mode

Power-on → Press the **Mode** button → Enter the Setting () mode → Press the **Menu** button.

Item	Option	Description
 Date & Time	-	Set date and time.
Beep	 On	Enable beep sound.
	 Off	Disable beep sound.
Flicker	 50Hz	Set flicker frequency to 50Hz. For settings reference, see page 45.
	 60Hz	Set flicker frequency to 60Hz. For settings reference, see page 45.
TV-out	 NTSC	Set TV system compatibility to NTSC. This option is suitable for America, Taiwan, Japan, and Korea areas.
	 PAL	Set TV system compatibility to PAL. This option is suitable for Germany, England, Italy, Netherlands, China, Japan, and Hong Kong.
 Icon	On	Enable OSD icons to display on the screen.
	Off	Disable OSD icons.
 LCD Bright	-2→+2	Set LCD brightness. A positive value makes the LCD brighter; while a negative value makes the LCD dimmer.
 Format	Yes	Format the storage medium. Note that all files stored in the medium will be gone.
	No	Cancel action.

● Menu items in Setting mode (continued)

Item	Option	Description
Auto Off	 Off	Disable Auto-off function.
	 1 min	The camera automatically shuts down when staying inactive for over 1 minute.
	 3 min	The camera automatically shuts down when staying inactive for over 3 minutes.
	 5 min	The camera automatically shuts down when staying inactive for over 5 minutes.
 Language	-	Lets you select the language used for OSD.
 Default	Yes	Restore factory defaults. Note that your current settings will be overridden.
	No	Cancel action.
 USB Mode	Menu	When connected to a PC, the camera displays a menu for you to choose a desired connection mode.
	Camera	When connected to a PC, the camera automatically enters Camera (PC camera) mode.
	Disk	When connected to a PC, the camera automatically enters Disk (removable disk) mode.
	Printer	When connected to a PC, the camera automatically enters Printer mode.

Copying Files to Your PC

● Installing the driver to your PC

You need to install the camera driver to ensure that video clips can be played back on your PC. To install the software:

1 Insert the driver CD.

Turn on your computer. Then place the accessory CD into the CD-ROM drive.

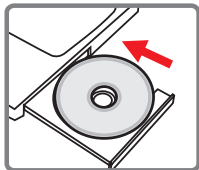

- ⚠ Do not connect the camera to your computer at this stage.
- ⚠ Shut down all other applications running on your computer.
- ⚠ If the autorun screen does not appear automatically, double-click on **My Computer** and then the CD-ROM drive. Then start the **Setup.exe** program manually.

2 Start the installation.

Click on the  icon to launch the installation of the driver.

- ⚠ **Notice for Windows 2000 users:**
During the installation process, a warning message regarding digital signature may appear twice or more. Please click on **Yes** to continue the process. The software is fully compatible with Windows 2000 operation system.

● Installing the driver to your PC (continued)

3 Install the driver.

The **Install Shield Wizard** will then appear and automatically install the program. Click on **Next** and follow the on-screen instructions to complete the installation.

4 Install codecs.

After the driver installation is completed, the program will prompt you to install **Windows Media Player Codecs**. If you are not sure whether the codecs have been installed in your computer, please click on **Yes** and follow the on-screen instructions to complete the installation.

5 Install Direct X 8.0 or above.

After the codecs installation is completed, you will be prompted to install **Direct X 8.0** or above if the program is not yet installed in your computer. Please click on **Yes** to continue.

❗ *Windows Media Player Codecs and Direct X 8.0 or above are necessary for viewing the video clips recorded by the camera.*

6 Restart the computer.

After the installation is completed, you may need to restart your computer for the driver to take effect.

● Connecting the camera to your PC

1 Connect the USB cable to your computer.

Turn on your computer, and then connect the accessory USB cable to the USB port of your computer. Make sure the cable and the port are correctly aligned.

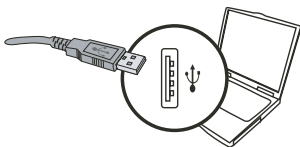

2 Connect the USB cable to your camera.

Connect the other end of the USB cable to your camera.

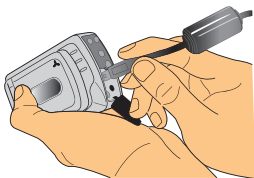



3 Turn on the camera and switch to Disk mode.

Turn on your camera. Use the joystick to select the Disk item and press the center of the joystick to confirm. Note that if the camera automatically enters Camera (PC camera) mode, you can press the **Menu** button to bring up the options menu.

ⓘ Notice for Windows 2000/XP/ME users:

If you want to disconnect the camera from your computer, please follow these steps:

1. Double-click  in the system tray.
2. Click  (USB Disk), and then click **Stop**.
3. Select the camera when the confirmation screen appears and click **OK**.
4. Follow the on-screen instructions to safely disconnect the camera from your computer.

● Copying files to the PC

1 This step varies depending on your operation system:

For Windows XP users:

After the camera is connected to your computer, a dialogue window will appear automatically. Please select the item **Open folder to view files using Windows Explorer** and click **OK**.

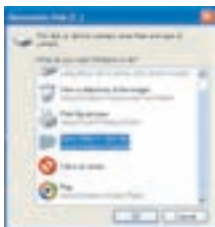

For Windows 2000/ME/98SE users:

Double-click on **My Computer**. Then double-click on the icon of the removable disk that has just appeared.

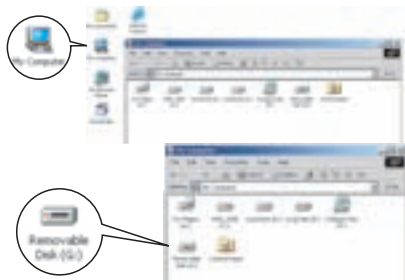

! Some users may find two removable disks appear in **My Computer**. That is because the OS detects two storage media in the camera (the internal memory and the SD/MMC card). If you have two removable disks and cannot find your files in one of the disks, try to find them in the other disk.

● Copying files to the PC (continued)

2 Double-click on the **DCIM** file folder.



Windows XP



Windows 2000/ME/98 SE

3 Double-click on the **100MEDIA** file folder.

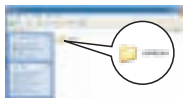

Windows XP



Windows 2000/ME/98 SE

4 Drag the target file into **My Documents** or the destination folder.

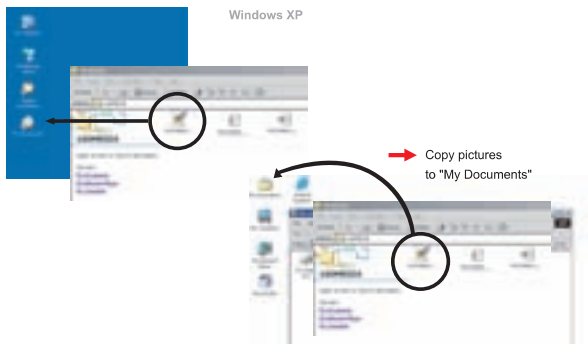

● Viewing/Playing files on your PC

- 1 Double-click on **My Documents** or any other folder that stores your files.



Windows XP

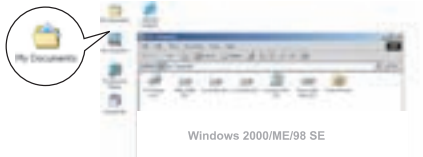

Windows 2000/ME/98 SE

- 2 Double-click on the desired file, and the file will be opened by the program matching the file type.



Windows XP



Windows 2000/ME/98 SE

● File location

After connecting the camera to your computer, a removable disk will appear in your computer. The removable disk actually represents the storage medium of your camera. In the disk you can find all of your recordings. Refer to the figure below to see where the files are stored.

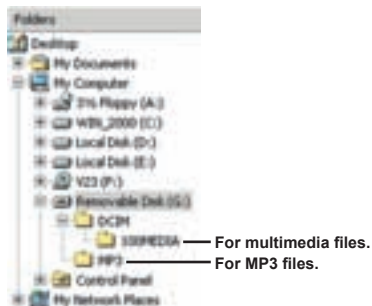

Using PC Camera

● Installing the software

The PC camera software is included in the camera driver, and therefore you should install the driver before using the PC camera function. If you have not yet installed the driver, see page 29 for details on the installation.

● Starting the application

1 Connect the camera to your computer.

Connect the camera to your computer using the accessory USB cable.

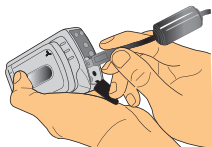

2 Turn on the camera and switch to Camera mode.

Turn on your camera. Use the joystick to select the Camera item and press the center of the joystick to confirm. Note that if the camera automatically enters Disk (removable disk) mode, you can press the **Menu** button to bring up the options menu.

❗ If you want to use the Video Conferencing function, please install programs such as **Netmeeting** to serve the purpose.

☛ Notice for Windows ME users:

When the indicated screen appears, please select **Automatic search for a better driver** and click **Next** to continue.

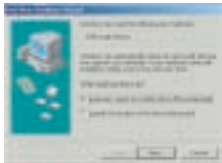

● Starting the application (continued)

☛ Notice for Windows 98SE users:

1. Click **Next** when the following screen appears.



2. When the following screen appears, select **Search for the best driver for your device** and click **Next** to continue.



3. During installation, some users may need to insert a licensed 98SE CD into the CD-ROM drive for copying the needed files.
4. Follow the on-screen instructions to complete the installation.

☛ Notice for Windows 2000 users:

When using the PC camera function for the first time, the warning message regarding digital signature may appear twice or more. Please click **Yes** to continue the installation. The camera is fully compatible with Windows 2000 operation system.

● Starting the application (continued)

3 Launch IS-DV program.

Double-click the **IS-DV** icon () on the Desktop to start the program. After the program starts, you can begin to use the PC camera function.

! If you cannot find the program shortcut on the desktop, you can start the program from the **Programs** menu.

● Using IS-DV PC Camera

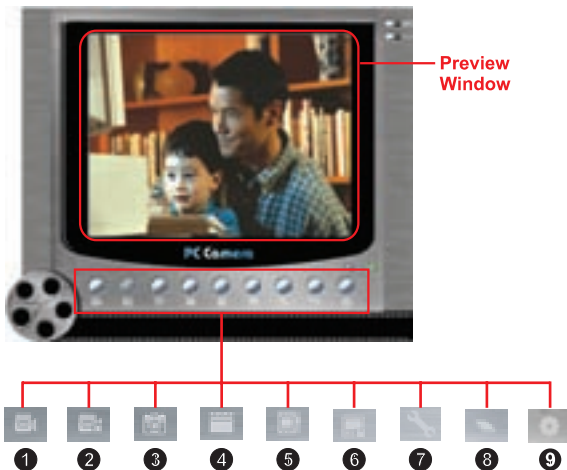



- | | |
|---------------------------------------|------------------------------------|
| 1 Start recording a video clip | 6 Start/Stop preview window |
| 2 Stop recording | 7 Setting * |
| 3 Snapshot | 8 Open album |
| 4 Format * | 9 Select video source |
| 5 Source * | * Sub-menu available. |

❗ To view pictures taken by IS-DV PC Camera, please click on  to open the photo album. Or, as an alternate option, go to the "Work Temp" folder to find the files. The full path is as following:

C:\Program Files\IS-DV\Work Temp

● Using IS-DV PC Camera (continued)

❖ Recording an AVI movie

1. Click on the  icon.
2. Press  to specify the path and name of the AVI file.
3. Set the frame rate and recording time according to your needs.
4. Press the **Start to Record** button to begin recording.
5. To stop recording, click on the  icon.

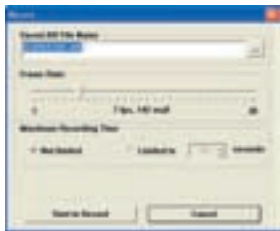

❖ Taking a snapshot

Click on the  icon to take a snapshot.

❖ Configuring Format options

■ Color Space:

Select one of the following functions according to your needs.

- RGB 24: This item is for retaining better quality.
- I420: This item indicates the AVI movie will be more compressed to gain the advantage of faster processing speed.

■ Output Size:

Set output size to change the size of the preview window. The default size is 320x240. Select larger pixels when you need a larger preview window.

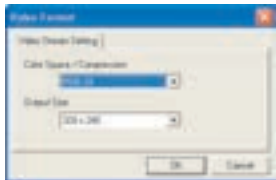

● Using IS-DV PC Camera (continued)

❖ Configuring Source options

■ Device Control:

- Brightness: You can check the “Auto” item and let the program adjust image brightness for you, or uncheck the “Auto” item and slide the bar to adjust image brightness manually.
- Quality: If the network bandwidth is congested when using PC Camera, slide the bar toward “Faster Video” to avoid this problem.



❖ Configuring Flicker options

If you take your camera abroad, and find the screen of your computer flickers when using PC Camera function, please check the Cancel Flicker item to prevent noises from appearing on the screen. Or, you can refer to the Flicker Settings table for proper flicker value that suits the country you are staying.

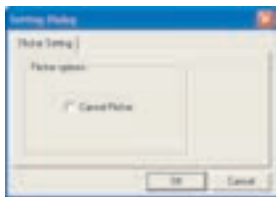

Addenda

➔ Troubleshooting

When using the camera:		
Problem	Cause	Solution
The camera can not be powered on normally.	The batteries are out of power.	Replace the batteries.
	The batteries are incorrectly installed.	Re-install the batteries.
The camera is still powered on, but the LCD screen does not display.	If the camera stays idle for over one minute, the LCD screen will automatically shut down to save power.	Press any button except the power button to reactivate the display.
Can not take pictures or video clips when pressing the Shutter or Record button.	Out of memory.	Free some space from the SD/MMC card or the internal memory.
	The camera is recharging the flash strobe.	Wait until the flash strobe is fully charged.
	Using a "protected" SD card.	Set the SD card to be writable.
The LCD screen displays "MEMORY ERROR" or "CARD ERROR" message. Or the camera cannot read the memory card.	The format of the memory card is not compatible with the camera.	Use the camera "Format" function to format the card.
	The memory card is corrupted.	Replace the memory card with a new one.

Addenda

When using the camera:		
Problem	Cause	Solution
I did not delete the pictures and video clips, but can not find them in the memory card.	The lost recordings are saved in the internal memory.	It happens when you insert a memory card after taking a few pictures or video clips. You can access those files after removing the memory card.
Cannot use the flash strobe.	If the battery life icon indicates low battery, the flash strobe may be disabled due to insufficient voltage.	Replace the batteries.
The camera does not respond to any action during operation.	The camera encounters software failure.	Remove the battery pack and replace it into the compartment. Then power on the camera.
The recorded pictures appear too blurred.	The focus is not correctly set.	Adjust the focus to an appropriate position.
The recorded pictures or video clips appear too dark.	The environment of shooting or recording does not have adequate light.	Use flash strobe when taking pictures. Add extra light sources when recording video clips.
Noises occur when viewing images on the LCD screen or on the computer.	The flicker setting does not match the standard of the country you are staying.	Adjust the flicker setting. For more information, please refer to the "Flicker Settings" table on page 45.

Addenda

When connecting the camera to the computer or TV:		
Problem	Cause	Solution
I cannot view the video clips on my computer.	Driver or software is not installed on the computer.	Install <i>Direct X 8.0</i> or above and <i>Windows Media 9.0 Codecs</i> to solve this problem. See page 29 for details on installing the software, or go to http://www.microsoft.com to download the required files.
Driver installation failed.	The installation is terminated abnormally.	Remove the driver and other related programs. Follow the installation steps in the manual to re-install the driver.
	The camera has been connected to the PC via the USB cable before installing the driver.	Install the driver before plugging in the USB cable.
The TV screen does not display after connecting the camera to the TV.	The camera is not correctly connected to the TV.	Reconnect the camera to TV correctly.
A conflict with other installed camera or capture device occurred.	The device is not compatible with the camera.	If you have any other camera or capture device installed in your computer, please completely remove the camera and its driver from the computer to avoid the conflict.
Noises occur on my computer screen when using Video Conferencing.	The flicker setting does not match the standard of the country you are staying.	Adjust the flicker setting. For more information, please refer to the "Flicker Settings" table on page 45.





Addenda

➔ Flicker Settings

Country	England	Germany	France	Italy	Spain	Netherlands
Setting	50Hz	50Hz	60Hz	50Hz	50Hz	50Hz
Country	Portugal	America	Taiwan	China	Japan	Korea
Setting	50Hz	60Hz	60Hz	50Hz	50/60Hz	60Hz

Note: The flicker setting is based on the frequency standard of your local power supply.

➔ Battery Life Indicator

Icon	Description
	Full battery life
	Moderate battery life
	Low battery life
	Empty battery life

Note: To avoid sudden outage of power supply, you are recommended to replace batteries when the icon indicates low battery life.

Addenda

➔ Storage Capacity

Memory	Video		Audio
	VGA	QVGA	Maximum
Flash memory (8MB for storage)	45 sec.	180 sec.	180 sec.
SD/MMC card (128MB)	450 sec.	1800 sec.	2400 sec.
SD/MMC card (256MB)	900 sec.	3600 sec.	4800 sec.
SD/MMC card (512MB)	1800 sec.	7200 sec.	9600 sec.
SD/MMC card (1GB)	3600 sec.	14400 sec.	19200 sec.

Memory	Still picture		
	5M	3M	1M
Flash memory (8MB for storage)	12	20	100
SD/MMC card (128MB)	140	240	1000
SD/MMC card (256MB)	280	480	2000
SD/MMC card (512MB)	560	960	5000
SD/MMC card (1GB)	1120	1920	10000

Note: The actual value of capacity may vary (up to $\pm 30\%$) depending on the color saturation and complexity of your subject and surroundings.

Addenda

➔ System Message

Message	Description
Recording	The camera is recording a file.
Please Unlock SD Card	If you insert a SD card and the card is set to "Protected", this message will show up when the camera tries to write data into the card.
No Files To Play	When the camera is set to Playback mode without any existing file to play, this message will show up.
Please Change Batteries	The battery life of the camera is low. You should replace the batteries with new ones immediately.
Memory Full	The storage memory is full and can not store any more files. Please change the SD/MMC card or delete some files to free some memory space.
Card Error	The inserted card is not compatible with the camera. Please change the card or try formatting the card.
Memory Error	The camera can not access data in the internal memory. Please format the medium to solve this problem.
Strobe Is Charging	The flash strobe is charging.
File Format Error	The file being played is not compatible with the camera.
Deleting	The camera is performing file deletion.
Formatting	The camera is formatting the storage medium.
Setting	The camera is performing a setting action.

Addenda

➔ Specifications

Main Functions

- Digital Video Camcorder (Video Resolution):
 - VGA (640 x 480 pixels) / up to 30 fps
 - QVGA (320 x 240 pixels) / up to 30 fps
 - Digital Still Camera (Hardware Resolution):
 - 5.0 Mega (2560 x 1920 pixels)
 - 3.1 Mega (2048 x 1536 pixels)
 - 1.3 Mega (1280 x 960 pixels)
 - MP3 Player: Full Function MP3 Player
 - Digital Voice Recorder
 - PC Camera:
 - VGA (640 x 480 pixels)
 - QVGA (320 x 240 pixels)
-
- Sensor Resolution: 3.1 Mega (2048 x 1536 pixels)
 - Max. Output resolution: 5.0 Mega (2560 x 1920 pixels)
 - Internal Memory: 32MB DDR Ram (for Processing)
16MB Flash memory (8MB for Storage)
 - External Memory: Built-in SD/MMC slot (Max: 1GB)
 - Digital Zoom: 4X
 - F/N: 2.8/5.6
 - TV-Out: Support NTSC/PAL TV System
 - Interface: USB 2.0
 - Built-in Microphone
 - Built-in Flash Strobe
 - Built-in Speaker
 - Battery: NP60 Li-ion Rechargeable Battery (3.7V 850mAh)
 - Power Saving: 1min/3min/5min/Off
 - Dimensions: 101.5 x 45.8 x 60 mm
 - Includes Battery Charger
-
- 1.8" LTPS panel
 - MPEG4 VGA 30fps
 - Video Stabilization
 - Direct Connect to Printer
-

Note: Specifications are subject to change without notification.