

OLYMPUS

UFL-3

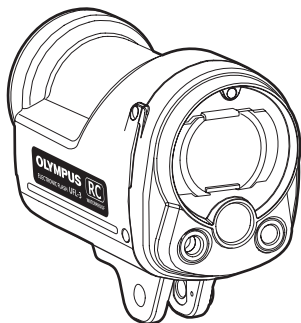

ENGLISH

EN Instruction Manual Electronic Flash

IMPORTANT SAFETY INSTRUCTIONS

When using your photographic equipment, basic safety precautions should always be followed, including the following:

- Read and understand all instructions before using.
- Close supervision is necessary when any flash is used by or near children. Do not leave flash unattended while in use.
- Care must be taken as burns can occur from touching hot parts.
- Do not operate if the flash has been dropped or damaged - until it has been examined by qualified service personnel.
- Let flash cool completely before putting away.
- To reduce the risk of electric shock, do not disassemble this flash, but take it to qualified service personnel when service or repair work is required. Incorrect reassembly can cause electric shock when the flash is used subsequently.
- The use of an accessory attachment not recommended by the manufacturer may cause a risk of fire, electric shock, or injury to persons.

SAVE THESE INSTRUCTIONS

Thank you for purchasing an Olympus product. Please read this instruction manual carefully and use the product safely and correctly. Please keep this instruction manual for reference after reading it.

Introduction

- Unauthorized copying of this manual in part or in full, except for private use, is prohibited. Unauthorized reproduction is strictly prohibited.
- OLYMPUS IMAGING CORP. shall not be responsible in any way for lost profits or any claims by third parties in case of any damage occurring from unsuitable use of this product.
- OLYMPUS IMAGING CORP. shall not be responsible for damage, lost profits, etc., caused by loss of image data because of defects, disassembly, repair or modification of this product by people other than third parties specified by OLYMPUS IMAGING CORP. or for other reasons.
- OLYMPUS IMAGING CORP. reserves the right to alter the features and contents of this publication without obligation or advance notice. For the latest information of product name and numbers etc., please contact your local service station.
- If you have any queries regarding this manual, please contact your local service station.

Please read the following items before use

This product is a precision device designed for use at a water depth within 75 m. Please handle it with sufficient care.

- Please read this instruction manual on handling and carrying out the system check as well as care, maintenance and storage of this product.
- OLYMPUS IMAGING CORP. shall in no way be responsible for accidents involving immersion of the flash. Any expenses incurred for damage of internal materials or loss of recorded contents caused by immersion of the flash will not be compensated.
- OLYMPUS IMAGING CORP. shall not pay any compensation for accidents (injuries or material damage) that may occur during the use of this product.

For customers in North and South America

Declaration of Conformity

This device complies with Part 15 of FCC Rules and Industry Canada licence-exempt RSS standard(s). Operation is subject to the following two conditions:

- (1) This device may not cause harmful interference.
- (2) This device must accept any interference received, including interference that may cause undesired operation.

Any unauthorized changes or modifications to this equipment would void the user's authority to operate.

This Class B digital apparatus complies with Canadian ICES-003. CAN ICES-3(B)/NMB-3(B)

For customers in Europe



"CE" mark indicates that this product complies with the European requirements for safety, health, environment and customer protection. "CE" mark cameras are intended for sales in Europe.



This symbol [crossed-out wheeled bin WEEE Annex IV] indicates separate collection of waste electrical and electronic equipment in the EU countries.

Please do not throw the equipment into the domestic refuse.

Please use the return and collection systems available in your country for the disposal of this product.

SAFETY PRECAUTIONS

This instruction manual uses a variety of common symbols and icons to assist you in proper handling and usage of this product properly, and to warn you of potential hazards to yourself and others as well as to property.

	An exclamation mark enclosed in a triangle alerts you to important operating and maintenance instructions in the documentation provided with the product.
DANGER	If the product is used without observing the information given under this symbol, serious injury or death may result.
WARNING	If the product is used without observing the information given under this symbol, injury or death may result.
CAUTION	If the product is used without observing the information given under this symbol, minor personal injury, damage to the equipment, or loss of valuable data may result.



DANGER

- This product is fitted with a high voltage circuit. Never dismantle or modify it. It may cause burns by a short circuit.
- Do not use this product in places with the risk of combustible and explosive gas present in the air. It may cause a fire or an explosion.
- Do not use the flash pointing to the driver etc. It may cause a serious accident.

 **WARNING**

- Never use the flash in front of the eyes especially for infants or children within 1 m. It may cause permanent vision impairment, etc.
 - Keep the flash and batteries out of the reach of infants and children. There is the possibility of the occurrence of the following types of accidents:
 - Swallowing of small parts. Please consult a physician immediately if any parts have been swallowed.
 - Triggering of the flash in front of the eyes may cause permanent vision impairment etc.
 - Injury from parts of the body getting caught in parts which open and close.
 - If the following cases occur regardless of use on land or underwater*, stop using it and turn off the power then remove the batteries immediately. Please consult your local service station or dealer:
 - If water or foreign objects come into contact with the electronic flash inside.
 - If water penetration can be seen on the inside of the flash.
 - If the product is in some way broken or internally exposed do not touch it under any circumstances. Regardless of the batteries being inserted, there is the possibility of an electrical shock by a short circuit.
- * When using in water, come to the surface as fast as possible, however, keeping in mind the needed time to come to the surface and the necessary decompression time, wipe the body of any water and take out the batteries.
- Do not store the flash in locations with high humidity or dust and much dust. It may cause a fire or an electrical shock.
 - Do not use the flash when covering the light-emitting part with an easily burnable item, such as a handkerchief.
 - Do not touch the light-emitting part with your hand soon after the continuous emission. It may cause burns.
 - The grease for silicone O-ring for this product is not edible.

 **CAUTION**

- If a bad smell, abnormal noise, deformation or smoke occurs stop use immediately, turn off the power, and remove the batteries. Be careful when removing the batteries as they may be hot. Contact your local service station or dealer before using the product, as it may cause a fire or burns.

- Do not place this product at locations with abnormally high or abnormally low temperatures or at locations with extreme temperature changes. The product may deteriorate or may cause a fire.
- Do not alter the battery compartment or try to insert any foreign objects into it.
- Do not store the flash at the locations subject to vibrations. It may cause malfunction.
- Opening and closing at locations with sand, dust, or dirt may impair the waterproof characteristic and cause water leakage. This should be avoided.
- This product has been designed and manufactured for use at a water depth within 75 m. Please note that diving at depths in excess of 75 m may cause deformation or damage to this product. In this case, water penetration may occur.
- Rough handling, such as jumping into the water with the flash in your hand or in an outside pocket or throwing the flash into the water could lead to water penetration. Please always take care when handing it from hand to hand etc.
- Before traveling by air, please make sure to remove the O-ring, otherwise the difference in air pressure may make it impossible to open the flash.

Battery handling precautions

Follow these important guidelines to prevent batteries from leaking, overheating, burning, exploding, or causing electrical shocks or burns.

DANGER

- Never heat or incinerate batteries. It could cause a fire or an explosion etc.
- Never contact terminals (+) and (-) with metal.
- Take precautions when carrying or storing batteries to prevent them from coming into contact with any metal objects such as jewelry, pins, etc. It may cause burns and an injury by short circuit.
- Battery shall not be exposed to excessive heat such as sunshine, fire or the like.
- Never store batteries where they will be exposed to direct sunlight, or subjected to high temperatures in a hot vehicle, near a heat source, etc. It may cause burns or an injury by battery fluid leaks, overheating or an explosion.

- Do not use solder, transform, modify or dismantle the batteries. There is the risk of destroying the terminal safety valve and the scattering of internal contents. It may cause a fire or an explosion.
- Do not connect the batteries to a power socket or car cigarette lighter. It could cause a fire or an explosion etc.
- If battery fluid gets into your eyes, flush your eyes immediately with clear, cold running water and seek medical attention immediately.

WARNING

EN

- Keep batteries dry at all times.
- Do not touch the batteries with wet hands. It may cause electrical shocks or malfunctions.
- To prevent batteries from leaking, overheating, or causing a fire, explosion or injury:
 - Use only batteries recommended for use with this product.
 - Never mix batteries (old and new batteries, charged and uncharged batteries, batteries of different manufacture or capacity, etc.).
 - Never attempt to charge alkaline or lithium batteries.
 - Insert the batteries carefully with the correct polarity as described in the operating instructions. Do not insert batteries forcibly into the battery compartment.
 - Never use batteries if their body is not covered by the insulating sheet or if the sheet is torn, as this may cause fluid leaks, fire, or injury.
 - Never use batteries if their body is not covered by the insulating sheet or if the sheet is torn even if they are sold as new ones.
- The following batteries cannot be used:

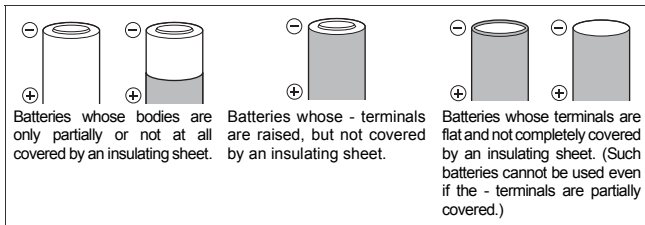

- If NiMH batteries are not charged within the specified time, stop charging them and do not use them. Please read the manual carefully to use the rechargeable batteries.
- Do not use batteries if they are cracked or broken. It may cause an explosion or overheating.
- If a battery leaks, becomes discolored or deformed, or becomes abnormal in any other way during operation, stop using it. It may cause a fire or an electrical shock. Please contact your local service station or dealer.
- Do not remove batteries immediately after using them. Batteries may become hot during prolonged use, which may cause burns.
- If a battery leaks fluid onto your clothing or skin, remove the clothing and flush the affected area with clean, running cold water immediately. If the fluid burns your skin, seek medical attention immediately.
- Never subject batteries to strong shocks or continuous vibration.
- Always remove batteries if they are not used for a long period. Otherwise, batteries may become overheated, leak fluid or cause a fire or an injury.

 **CAUTION**

- Keep batteries' terminals clean. If they are not clean from sweat or grease, it may cause contact failure. Clean them with a dry cloth.
- Using batteries at a low temperature may cause a shorter battery life or lower performance. Using the batteries at a moderate temperature will restore the performance.
- Before going on a long trip, and especially before traveling abroad, purchase an ample supply of extra batteries. The recommended batteries may be difficult to obtain while traveling.

About O-ring

Please note the following points to use the O-ring.

- When sealing this product, make sure that no hairs, fibers, sand particles or other foreign matter stick not only to the O-ring, but also to the contact surface. Even a single hair or a single grain of sand may cause water leakage. Please check with special care.

Examples of foreign matter sticking to the O-ring

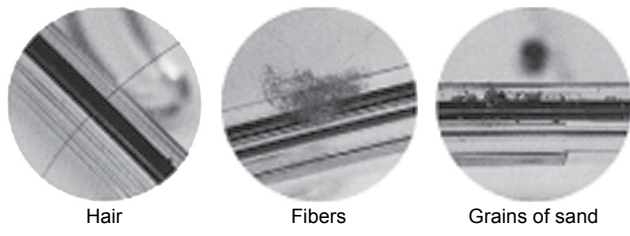

EN

- The O-ring is a consumption product. Please replace it at least once a year with a new one. Also perform maintenance with every use.
- Deterioration of the O-ring will progress according to the conditions of use and the storage conditions. Immediately replace the O-ring with a new one if it is damaged, shows cracks, or has lost its elasticity.
- At the time of O-ring maintenance, clean the inside of the O-ring groove and confirm the absence of dirt, dust, sand, and other foreign matter.
- Apply the specified silicone O-ring grease to the O-ring.
- The waterproof function is not effective when the O-ring is not installed correctly. When installing the O-ring, take care that it does not project from the groove and that it is not twisted. Also, when installing the battery cap, close it after confirming that the O-ring has not come out of the groove.

Handling the product

- Use or storage of the product at the following locations may cause defective operation, defects, trouble, damage, a fire, internal clouding, or water leakage. Always avoid these locations:
 - Place in direct sunlight such as in a closed vehicle.

- Places where there are open fires.
 - Places where water is deeper than 75 m.
 - Places subject to vibrations.
 - Places where high temperatures exist or high humidity and/or where extreme differences in temperatures exist.
 - Places where volatile chemicals are stored or used.
- Do not apply excessive force on the arm mount.
 - In order to prevent the flash from overheating and losing quality, after using the flash consecutively on full power, stop after 10 times for a period of 10 minutes and allow the flash to cool down.
 - When this product is not used for a long time, the O-ring may deteriorate, diminishing its waterproof properties. Please check the O-ring before use.
 - Do not use the following chemicals for cleaning, corrosion prevention, prevention of fogging, repair or other purposes. When these are used for the flash directly or indirectly (with the chemicals in vaporized state), they may cause cracking or other problems.

Chemicals which cannot be used	Explanation
Volatile organic solvents, chemical detergents	Do not clean the flash with alcohol, gasoline, thinner or other volatile organic solvents or with chemical detergents etc. Pure water or lukewarm water is sufficient.
Anticorrosion agent	Do not use anticorrosion agents. The metal parts use stainless steel or brass, and washing with pure water is sufficient.
Adhesive	Do not use adhesive for repairs or other purposes. When repair is required, please contact your local service station or dealer.

- Do not perform operations other than specified in this instruction manual, do not remove or modify parts other than specified, and do not use parts other than specified.
Any troubles in taking pictures or with the equipment resulting from the above actions shall be outside the guarantee.

Contents

EN

Introduction.....	2
Please read the following items before use.....	2
SAFETY PRECAUTIONS.....	3
Battery handling precautions.....	5
About O-ring.....	8
Handling the product.....	8
1. Name of the Parts.....	12
Flash.....	12
Checking the package contents.....	12
2. Maintaining the Waterproof Function.....	14
Removing the O-ring.....	14
Removing any sand, dirt, etc.....	15
Applying grease to the O-ring.....	16
Installing the O-ring.....	16
3. Inserting the Batteries.....	17
Usable batteries (sold separately).....	17
Inserting the batteries.....	17
4. Mounting the Flash.....	19
Attaching to an arm.....	19
Connecting to a camera's underwater case.....	20
5. Using as TTL (auto-modulating) flash.....	21
Turning on the electronic flash.....	21
Shooting.....	22
Using with RC A mode.....	22
Using with RC B mode.....	22
Shooting.....	22
6. Using as Slave Flash.....	23
Using the diffuser.....	24
Attaching the diffuser.....	24
Detaching the diffuser.....	25
7. Handling After Shooting.....	26
Cleaning the flash with pure water.....	26
Wiping off any waterdrops.....	26
Removing the batteries.....	26



Drying the flash.....	27
Perform maintenance on the O-ring	27
Replace consumable products	27
8. Appendix	28
Q & A on the use of the UFL-3	28
Troubleshooting.....	32
Specifications	33

1. Name of the Parts

Flash

EN

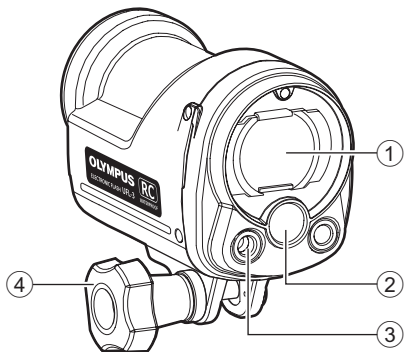

- ① Light emitting part
- ② Target light

- ③ Fiber-optic cable socket
- ④ Arm mount knob

Checking the package contents

The items listed at the right are included with the electronic flash.

Contact your local service station or dealer if accessories should be missing or damaged.

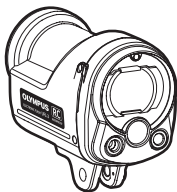

Electronic flash
(main body)

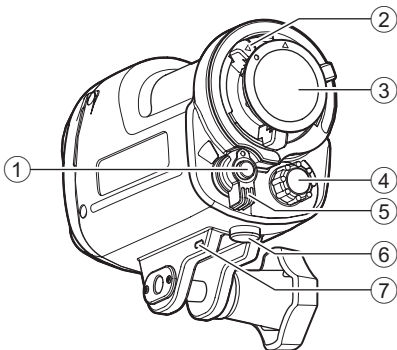

① button

- The target light turns on when press this button. The target light turns off when press this button again.
- The target light turns off when the flash emits, and lights up again when the flash is ready to emit (when the Ready lamp turns in red).

② Battery cap lock

③ Battery cap

④ Light level dial

⑤ Mode dial

⑥ Ready/TTL lamp

- Turns in red when the flash is ready.
- Turns in green for approx. 2 seconds after emitting with TTL flash output.

⑦ Strap eyelet



Silicone grease

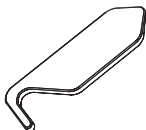

O-ring remover

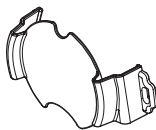

Diffuser



Arm mount knob



Diffuser strap

- Instruction manual (this manual)

2. Maintaining the Waterproof Function

This product is sealed with an O-ring. Maintenance of the waterproof function is required even before using this product underwater for the first time.

For handling the O-ring, refer to P.8.

Removing the O-ring

EN

Open the battery cap (▶ P.17) and remove the O-ring from the battery cap.

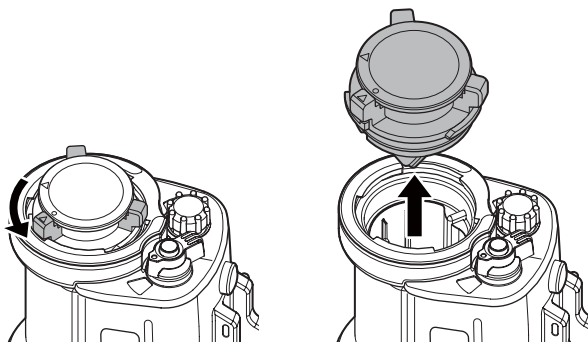

- ① Insert the O-ring remover between the O-ring and the wall of the O-ring groove.
- ② Move the tip of the inserted remover under the O-ring. (Take care not to damage the O-ring groove with the tip of the remover.)
- ③ Hold the O-ring with your fingertips after it has come out of the groove and remove it from the flash.

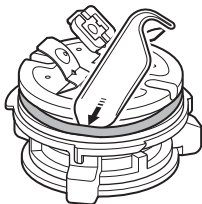

Removing any sand, dirt, etc.

After visually checking that dirt, sand, and other foreign matter has been removed from the O-ring, check for damage and cracks by squeezing the entire circumference of the O-ring lightly with your fingertips.

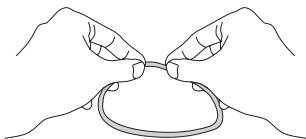



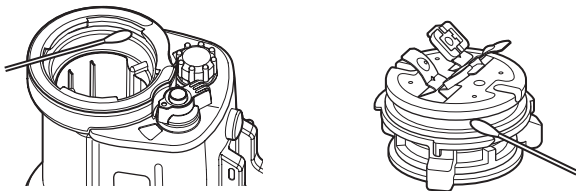

Using a clean cloth free of fibers or a lint-free cotton swab, remove any foreign matter attached to the grooves of the O-ring. Also remove sand and dirt particles attached to the O-ring contact surface (battery cap side).



⚠ CAUTION

- When a mechanical pencil or a similar other sharp object is used to remove the O-ring or to clean the inside of the O-ring groove, the O-ring may be damaged and water leakage may be caused. Please use the provided O-ring remover.
- When the O-ring is checked with the fingertips, take care not to stretch the O-ring.
- Never use alcohol, thinner, benzene or similar solvents or chemicals detergents to clean the O-ring. When such chemicals are used, it is likely that the O-ring will be damaged or that its deterioration will be accelerated.
- Deterioration of the O-ring is accelerated by the conditions of use and the storage conditions. Replace the O-ring even before a year has passed if it shows signs of damage, cracking or loss of elasticity.

Applying grease to the O-ring

1	Apply the specified grease.		Make sure there is no dirt on your fingers or on the O-ring; then squeeze about 10 mm of grease onto your fingertip.
2	Spread the grease over the O-ring.		Using two fingers and a thumb, spread the grease over the O-ring while rubbing it in. Use caution not to squeeze or pull the O-ring too hard.
3	Check that there is no damage or irregularities on the O-ring.		Once the grease has permeated throughout the O-ring, check it for damage or irregularities (both visually and by touch). If you notice any abnormalities, replace the O-ring with a new one.
4	Apply the grease to the O-ring contact surface.		Use any residual grease on your fingertips to clean and lubricate the O-ring contact surface on the flash.

EN

Installing the O-ring

Confirm that no foreign matter is attached, apply a thin coat of the accessory grease to the O-ring, and fit the O-ring into the groove. At this time, confirm that the O-ring does not stick out from the groove.

CAUTION

- Always perform maintenance of the waterproof function even when the battery cap has been opened to exchange the battery. Neglecting this maintenance may result in water leakage.
- When the flash is not to be used for a long time, remove the O-ring from the groove to prevent deformation of the O-ring, apply a thin coat of silicone grease, and store it in a clean plastic bag.
- When drying is done with salt attached, it is likely that a function impairment will be caused. After use, always wash off any salt.

Examples of foreign matter sticking to the O-ring

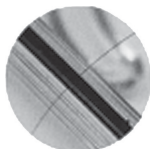

Hair



Fibers

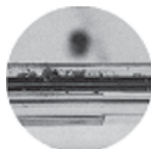

Grains of sand

3. Inserting the Batteries

Usable batteries (sold separately)

Always use one of the following battery combinations:

AA alkaline batteries/AA NiMH batteries

- Manganese batteries are not to be used.

Inserting the batteries

While installing and exchanging batteries make sure to wipe off the any water from flash and always use dry hands. Pay especial attention for any drips from hair and wetsuits.

- ① Make sure that the mode dial is in the OFF position.
- ② Turn “a” counter-clockwise to the OPEN ● position.
- ③ Pull the battery cap straight out.
- ④ Insert four batteries aligned to the + and – marks.
- ⑤ Take care to insert the batteries in the correct direction.
 - Check the O-ring to make sure there are no scratches or debris, and apply a light coating of the included silicon grease. (👉 P.16)

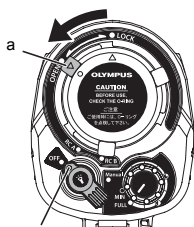

Mode dial

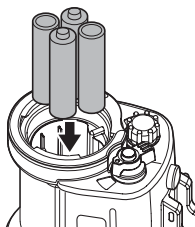

- ⑥ Align the round mark and “a” on the battery cap with the OPEN ● position, insert the battery cap into the flash.

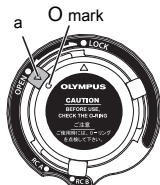

EN

- ⑦ Turn “a” clockwise to the LOCK position. Turn until you hear the sound of it clicking into place.

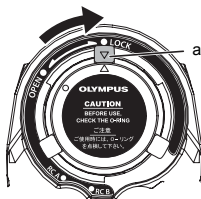

⚠ CAUTION

- Make sure to use the same type of batteries.
- Always replace all batteries at the same time.

4. Mounting the Flash

Attaching to an arm

Attach the flash to the arm. When attaching the arm to the camera, make sure to read the arm's instruction manual on how to attach the arm.

- ① Loosen the arm mount knob by turning in an counterclockwise direction.
- ② Place part **A** in the space between the arm mount.
- ③ Turn the loosened knob, in step ①, in a clockwise direction all the way to clamp the arm to the flash.
 - Be sure to double check the arm is firmly fastened to the flash.

EN

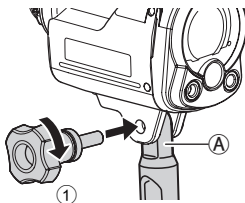

It is possible to adjust the direction of the flash while turning on the target light.

Connecting to a camera's underwater case

Connect the flash to the camera's underwater case. Use the underwater fiber optic cable (optional) for connection.

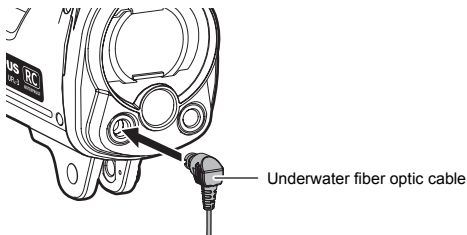

- Insert the plugs of the underwater fiber optic cable into the connectors on the camera's underwater case and on the flash's fiber optic cable, all the way in until the black rod of the connector to be inserted completely.
- You can connect and disconnect the underwater fiber optic cable while under water.
- For further details, refer to the instruction manuals of the underwater fiber optic cable (optional) and the camera's underwater case.

5. Using as TTL (auto-modulating) flash

When using the flash with a camera equipped with a wireless RC flash function, it can be used as the TTL (auto-modulating) flash. The light quantity of this flash can be controlled automatically by the setting of the flash mode, correction of the light emission amount and so forth on the camera. For information about the setting of the camera, refer to the camera's instruction manual.

Turning on the electronic flash

- ① Turn the mode dial to set one of the RC A or RC B.
The flash turns on.

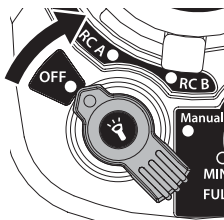

To turn off, turn the mode dial to set the OFF position.

The Ready/TTL lamp turns red when the charging is completed and the flash emission is possible.

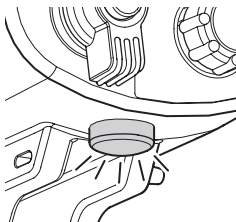

⚠ CAUTION

- If it takes 30 seconds or more to reach the state that the flash emission is possible after the power is turned on or the Ready/TTL lamp goes off, replace batteries with new ones.
- The electronic flash automatically turns off when no operations are performed for 30 minutes. Turn it on again.

Shooting

Using with RC A mode

Operates according to the setting of the A group of the RC mode on the camera.

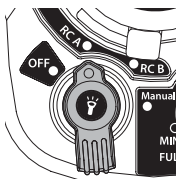

EN

- ① Turn the mode dial to set "RC A".
- ② Set the camera's RC mode to ON and set the camera's built-in flash so as to allow it to be emitted.
- ③ Set the camera's RC flash (emits in accordance with the setting of the A group).
 - Set the channel to "1".
 - This flash is not emitted when set the "Auto" or "Super FP Flash" in the camera.

Using with RC B mode

Operates according to the setting of the B group of the RC mode on the camera.

- ① Turn the mode dial to set "RC B".
- ② Set the camera's RC mode to ON and set the camera's built-in flash so as to allow it to be emitted.
- ③ Set the camera's RC flash (emits in accordance with the setting of the B group).
 - Set the channel to "1".
 - This flash is not emitted when set the "Auto" or "Super FP Flash" in the camera.

Shooting

After Ready/TTL lamp lights in red, press the camera's shutter button. If the TTL auto-modulation functions is worked at the time of emission, Ready/TTL lamp lights in green for approximately 2 seconds.

6. Using as Slave Flash

When using the flash with a camera that is not equipped with a wireless RC flash function, use as a manual flash. Set the amount of light emission manually.

- ① Turn the mode dial to set "Manual".
- ② Turn the light level dial to set the light level (GNo.).
- ③ Setup the camera in the following way.
 - Set cameras with slave mode to slave mode.
 - Set cameras with manual flash emission mode to manual flash mode. This setup will function also if you attach an external flash with manual flash emission mode to the camera.

EN

CAUTION

- The slave flash mode cannot be used with cameras that perform a pre-flash because the electronic flash will be emitted simultaneously with the pre-flash.
- If other photographers are shooting using flash, the electronic flash may react to those lights and be emitted.

Using the diffuser

Use of the diffuser is highly recommended for shooting short camera-to-subject distances.

Attaching the diffuser

- 1 Attach the included diffuser strap to the strap eyelets on the diffuser and the flash.

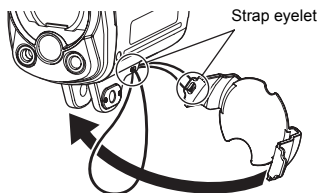

- 2 Align the grooves on the top and bottom of the diffuser with the protrusions on the reflector.
- 3 Firmly set the tabs on the diffuser into the grooves on the right and left side of the body.

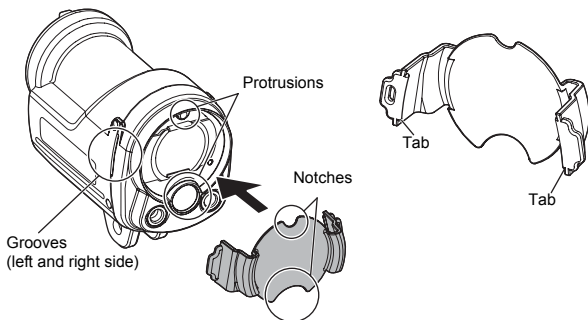

⚠ CAUTION

- Always make sure that the diffuser is properly attached before use. If not properly attached, it may fall off, get lost or become damaged.

Detaching the diffuser

Pinch in and pull up on the tabs (A) simultaneously to remove the tabs from the side grooves.

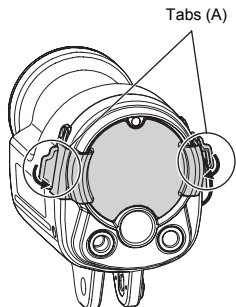

EN

⚠ CAUTION

- Do not try to forcibly remove the diffuser with the tab on only one side as doing so may cause breakage.

7. Handling After Shooting

Cleaning the flash with pure water

After using this flash, seal it again with the battery cap and rinse it with pure water as soon as possible. After use in salt water, the flash should be immersed for an extended period of time in a bowl of pure water to remove any salt water or salt residues.

Operate the switches of the flash when it is in clean tap water to remove any salt from their shafts.

CAUTION

- Leakage may occur to some parts if exposed to high water pressure.
- Do not disassemble the flash for cleaning.
- If the flash is dried before all salt has been removed, this could affect its performance. Always make sure all salt has been removed.

Wiping off any waterdrops

After underwater shooting, remove any drops of water from the flash. Use pressurized air or lint-free cloth to carefully wipe away any water from the buttons, the battery cap and the gaps between the battery cap and the body of the flash.

CAUTION

- Waterdrops may spill into the flash when the battery cap is removed, especially when they remain between the flash and the battery cap. Take special care to wipe off all waterdrops.

Removing the batteries

- ① Remove the battery cap and take out the batteries.
- ② After removing the batteries, be sure to replace the battery cap.

CAUTION

- Before opening the battery cap, make sure that your hands or gloves are free of sand, fibers, etc.
- Do not open or close the battery cap at locations where water or sand may be sprayed. When this cannot be avoided because you have to exchange the battery, place a sheet upwind from some object and take care that no water or sand is sprayed.
- Never touch the batteries when your hands are wet with salt water.

Note :

Moisten a towel etc. in advance with pure water and keep it in a plastic bag so that you can wipe the salt from your hands and fingers before handling the flash.

Drying the flash

After washing the flash, dry it with a clean, soft, lint-free cloth. Then, leave it to dry completely in a well-ventilated location protected from direct sunlight.

⚠ CAUTION

- Never use hot air from a hair dryer or other appliance to dry the flash. This could deteriorate or deform the flash and O-ring and lead to water penetration.
- When wiping the flash, take care not to scratch it.

EN

Perform maintenance on the O-ring

Always carry out maintenance on the O-ring after use, to maintain optimum waterproofing performance.

See “2. Maintaining the Waterproof Function” (👉 P.14)

Replace consumable products

- The O-ring is a consumable product. Independent of the number of times the flash is used, it is recommended that the O-ring should be replaced by a new one at least once a year.
- Deterioration of the O-ring is accelerated by the conditions of use and the storage conditions. Replace the O-ring even before a year has passed if it shows signs of damage, cracking or loss of elasticity.

Note :

Please use original Olympus silicone O-ring grease and the O-rings. These products can be purchased at an Olympus service station.

8. Appendix

Q & A on the use of the UFL-3

Q1: What cautions must be observed when taking off the battery cap?

A1: Pay attention to the following points:

- ① Take the cap off in a place where it is safe from spray and the scattering of sand.
- ② Wipe off all water drops in the gap between the battery cap and the body, and any place that is uneven. As when taking off the cap water drops may run inside.
- ③ Make sure there is no rubbish, hair or other foreign matter sticking to the O-ring and O-ring contact surface (battery cap side).
- ④ Before returning the battery cap, make sure the O-ring is correctly aligned with the O-ring groove on the battery cap.

Q2: What cautions must be observed when using and storing the flash?

A2: ① When the flash is used, left or stored at the following locations, defective operation or trouble may be caused. Always avoid such locations:

- Places where the flash can reach high temperatures under direct sunlight or in a car, places with extremely low temperatures, and places with extreme temperature variations.
 - Places with open fire
 - Places with volatile substances
 - Places with vibrations
- ② The following instances could lead to operational problems and/or damage to this flash. Avoid knocks and sudden increases in pressure caused by:
- Hitting other objects
 - Dropping
 - Placing heavy objects on top of the flash
- ③ When the flash is not used for a long time, trouble from formation of mold etc. may be caused. Before use, confirm the operation of all operating parts and perform the O-ring maintenance.
See "2. Maintaining the Waterproof Function" (🔍 P.14)
- ④ Store the flash after removing the batteries.

Q3: How to handle the flash after use?

A3: Refer to P.28.

Q4: What are the causes for entry of water?

A4: The main causes for the entry of water are shown below. Please check them most carefully.

- ① Forgetting to install the O-ring
- ② The O-ring is partly or completely outside the groove
- ③ Damage, deterioration, or deformation of the O-ring
- ④ Sand, fibers, hair or other foreign matter on the O-ring
- ⑤ Sand, fibers, hair or other foreign matter on the O-ring groove or the O-ring contact surface
- ⑥ Throwing the flash from a boat into the water, jumping with the flash into the water, or other sudden application of strong forces onto the flash. When entering the water, hand the flash over gently or avoid impacts in other ways.

Q5: What are the important points for O-ring maintenance?

A5: Please observe the following items.

- ① Never use alcohol, thinner, benzene or similar organic solvents or chemical detergents to clean the O-ring. When such chemicals are used, it is to be feared that the O-ring will be damaged or that its deterioration will be accelerated.
- ② Use the original Olympus silicone O-ring grease (white cap). The grease of other companies are not suitable for this silicone O-ring, and use of such grease may cause deterioration of the surface and impairment of the waterproof function.
- ③ In order to avoid deformation of the O-ring when the flash is not used for a long time, remove the O-ring from the flash, apply the special grease, and store the O-ring in a clean plastic bag. For reuse, confirm that the O-ring is free of damage and cracks, that it has sufficient elasticity, that the surface is free of stickiness and other abnormalities, and use it after applying a thin coat of the special grease. Excessive application of grease does not improve the waterproof function or the maximum level of pressure. However, it may facilitate attachment of sand, dirt, etc. A thin, uniform coat produces the best result.
- ④ The O-ring is a consumable product. Replace it at least once a year.
- ⑤ Deterioration of the O-ring is accelerated by the use conditions and the storage conditions. Replace the O-ring immediately by a new one if it shows signs of damage, cracking or loss of elasticity.

Q6: What are the important points for the flash maintenance?

A6: Please observe the following items. Never use the following chemicals for cleaning, corrosion protection, repair or other purposes:

- Never use alcohol, thinner, benzene or similar volatile organic solvents or chemical detergents to clean the flash. Pure water or lukewarm water is sufficient for cleaning.
- Do not use anticorrosion agents on the metal parts. The metal parts are made of aluminum, brass or stainless steel. Cleaning with pure water is sufficient.
- Do not use adhesive for repairs or other purposes. When repair is required, please contact your local service station or dealer.

Q7: Please tell me about repairs.

A7: Please contact your local service station or dealer, if repairs should be necessary. Do not try to repair, disassemble or modify the flash yourself. Repair, disassembly or modification by you or third parties not authorized by Olympus invalidates the guarantee.

Q8: What are the model numbers of the UFL-3 accessories?

A8: The following accessories are being sold.

O-ring for the battery cap (POL-U1)

Silicone O-ring grease (PSOLG-1/2/3)

- * Please contact your local service station or dealer when replacement is required. Replacement will be made against payment.

Troubleshooting

Q: What is the recommended white balance setting for the camera when using the electronic flash?

A: The auto white balance mode is recommended. If you use the manual white balance mode, set the color temperature to around 5400K. Note that the color temperature varies depending on the flash intensity.

EN

Q: The flash wasn't emitted when shooting in RC mode. What is wrong?

A: Verify that the camera and the electronic flash are set to the same channel and that the group is set correctly.

Q: How can I find out if my camera is compatible with wireless flash?

A: You can use the RC mode only with cameras compatible with the Olympus wireless RC flash system. With other cameras you may be able to use the electronic flash as slave flash if the camera's built-in flash can be set to slave flash mode or manual flash mode. For details, refer to the camera's instruction manual.

Q: Why did the electronic flash automatically turn off?

A: The electronic flash automatically turns off when no operations are performed for 30 minutes. Turn it on again.

Specifications

MODEL NO.	UFL-3
Type	Electronic flash for the Olympus underwater-use digital camera
Guide Number	22 (land shooting, flash intensity at FULL)
Firing angle	Equivalent to image angle of 24 mm (35mm conversion) lens (land shooting)
Flash emission count	AA alkaline batteries: Approx. 240 times AA NiMH batteries (1900 mAh): Approx. 330 times
Recharge time (Full flash)	AA alkaline batteries: Approx. 2.6 seconds AA NiMH batteries (1900 mAh): Approx. 1.9 seconds
Flash modes	TTL Manual
Light Temperature	5400 K
Waterproofing	75 m
Operating environment temperature	0°C to 40°C (32°F to 104°F)
Power supply	AA alkaline batteries/AA NiMH batteries (four)
Dimensions	69 mm (W) × 109 mm (H) × 133 mm (D) (excluding protrusions)
Weight	Approx. 465 g (without batteries)
Weight under water	Approx. 10 g (including batteries, in the freshwater)

* We reserve the right to change the external appearance and the specifications without notice.

OLYMPUS

<http://www.olympus.com/>

OLYMPUS IMAGING AMERICA INC.

3500 Corporate Parkway, P.O. Box 610, Center Valley, PA 18034-0610, U.S.A. Tel. 484-896-5000

Technical Support (U.S.A. / Canada)

24/7 online automated help:

<http://www.olympusamerica.com/support>

Phone customer support:

Tel. 1-800-260-1625 (Toll-free)

Our phone customer support is available from
9 am to 9 pm (Monday to Friday) ET

<http://olympusamerica.com/contactus>

Olympus software updates can be obtained at:

<http://www.olympusamerica.com/digital>

OLYMPUS EUROPA SE & CO. KG

Premises: Consumer Product Division
Wendenstrasse 14-18, 20097
Hamburg, Germany

Tel: +49 40-23 77 3-0 / Fax: +49 40-23 07 61

Goods delivery: Modul H, Willi-Bleicher Str. 36,
52353 Düren, Germany

Letters: Postfach 10 49 08, 20034 Hamburg,
Germany

European Technical Customer Support:

Please visit our homepage <http://www.olympus-europa.com> or call our TOLL FREE NUMBER* :
00800 - 67 10 83 00

for Austria, Belgium, Czech Republic, Denmark, Finland, France, Germany, Luxemburg,
Netherlands, Norway, Poland, Portugal, Russia, Spain, Sweden, Switzerland, United Kingdom.

* Please note some (mobile) phone services / provider do not permit access or request an
additional prefix to +800 numbers.

For all not listed European Countries and in case that you can't get connected to the above mentioned number,
please make use of the following CHARGED NUMBERS **+49 40 - 237 73 899**