



Final 300i loudspeaker User Manual

release 1.4 –US-

Final Sound B.V. Eisenhowerweg 8D 5466AC Veghel The Netherlands <http://www.finalsound.com>

Final Sound, L.L.C. 500 West Cummings Park, Suite 2500 Woburn, MA 01801 T:(781) 938-6416 F:(781) 938-6415

TABLE OF CONTENTS

1.	Safety Instructions.....	3
2.	Panel safety.....	4
3.	Congratulations	5
4.	Final Sound Model F300i floor standing loudspeakers.....	6
5.	Final Sound 300i wall mountable loudspeakers	11
6.	Final Sound center loudspeaker	13
7.	Final Sound subwoofer.....	16
8.	300i specifications	21
9.	Frequently asked questions	22
10.	Warranty.....	27
11.	Limited Warranty Registration Card	29

1. Safety Instructions



WARNING:

Do not exposure to rain, moisture or high humidity.

Do not open - High voltage inside

Do not cover the speaker. (e.g. with curtains)

Use only a mains-adaptor approved for the country of use.

Refer servicing to a qualified Final Sound dealer.

Important Safety Instructions:

- 1) Read these instructions.
- 2) Keep these instructions.
- 3) Heed all warnings.
- 4) Follow all instructions.
- 5) Do not use this apparatus near water.
- 6) Clean only with dry cloth.
- 7) Do not block any ventilations openings. Install in accordance with the manufacturer's instructions.
- 8) Do not install near any heat sources such as radiators, heat registers, stoves, or other apparatus (including amplifiers) that produce heat.
- 9) Do not defeat the safety purpose of the polarized or grounding-type plug. A polarized plug has two blades with one wider than the other. A grounding type plug has two blades and a third grounding prong. The wide blade or the third prong is provided for your safety. If the provided plug does not fit into your outlet, consult an electrician for replacement of the obsolete outlet
- 10) Protect the 12V DC power adaptor cord from being walked on or pinched particularly at plugs, convenience receptacles, and the point where they exit from the apparatus.
- 11) Use only with the cart, stand, tripod, bracket, or table specified by the manufacturer, or sold with the apparatus. When a cart is used, use caution when moving the cart/apparatus combination to avoid injury from tip-over.
- 12) Unplug this apparatus during thunderstorms or when unused for long periods of time.
- 13) Refer all servicing to qualified service personnel. Servicing is required when the apparatus has been damaged in any way, for instance when the power-supply cord or plug is damaged, liquid has been spilled or objects are fallen into the apparatus, the apparatus has been exposed to rain or moisture, does not operate normally, or has been dropped.
- 14) Do not open the apparatus.
- 15) To reduce the risk of electric shock, do not remove the back panel of the subwoofer. There are no user-serviceable parts inside. Refer servicing to a qualified Final Sound dealer.



Warning: High Voltage Inside. To reduce the risk of fire or electric shock, do not expose this apparatus to rain or moisture.

Warning: The apparatus shall not be exposed to dripping or splashing and no objects filled with liquids, such as vases, shall be placed on the apparatus.

Explanation of used symbols:



This flash symbol indicates that the outlet carrying this symbol is carrying a dangerous voltage.



The double insulation symbol indicates a double insulated product. In a double-insulated product, two systems of insulation are provided instead of grounding.



The exclamation mark indicates that special attention has to be given to the indicated remark.

2. Panel safety

Listening to electrostatic loudspeakers is a unique experience, well known by music friends dedicated to inner detail, neutrality, soundstage and reality. Music lovers, addicted towards electrostatic transducers, don't select their panels because of sheer sound pressure level output or the ability to shake the rafters. They like the inner qualities of electrostatic performance and what the panels can tell you about the music and the qualities of the recording. Although the Final electrostatic loudspeakers can reach respectable sound pressure levels and will easily exceed levels used during normal listening practice, we do not recommend to use these panels for PA applications or to overwhelm the audience during parties. Final panels are protected against accidental overload, but every protection circuit in a loudspeaker is a deliberately chosen compromise. Protecting against every possible fault condition is, from a music reproduction point of view, a serious trade off.

3. Congratulations

Congratulations on your purchase of a Final Sound flat-panel loudspeaker system.

You have invested in the finest instrument for audio reproduction available. The Final Sound product line consists of front- and rear flat-panel loudspeakers, center loudspeakers and subwoofers.

The product line is based on a unique modular system. Final Sound offers you the possibility to start buying a stereo system and easily extend this at any convenient time into a complete Final Sound Home Theatre system. You can do this just by adding a center loudspeaker and/or another set of Final Sound flat-panel loudspeakers.

The Final product line is designed to surpass the performance of other existing loudspeakers and contains some of the most elegant and sophisticated designs ever used for music reproduction.

Our flat-panel loudspeakers are capable of producing very pure and accurate sound due to their ultra low mass diaphragm. The Final Sound technology has evolved through many years of research and development.

The Final Sound subwoofers are designed to match perfectly with the characteristics of the Final Sound loudspeaker panels.

The Model F300i loudspeakers are designed for the use in a stereo setting, a virtual surround system or a so-called 5.1 home theatre configuration.

The Model F300i flat-panel loudspeakers are floor-standing loudspeakers. However, Final Sound provides a wall mountable version of the 300i panel.

300i-based stereo system

The Final Sound Model F300i stereo system consists of the following components:

- 2 F300i Final Sound flat-panel loudspeakers (left and right channel).
- The F300i does not reproduce frequencies below 95Hz. Therefore it is very important that a subwoofer, such as our S110 or S220 (purchased separately), that can reproduce the lower frequencies be used.

300i-based home theatre system

It is simple to build a 300i-based home theatre system with the following components:

- 4 F300i Final Sound flat-panel loudspeakers (left, right and surround channels).
- A Final Sound center panel (150i, 300i or 400i).
- A subwoofer (S110 or S220).

300i-based virtual surround system

- 2 F300i Final Sound flat-panel loudspeakers (left and right).
- A receiver or processor with virtual surround capability (SRS or Dolby Virtual) or a Final Sound virtual surround receiver.
- A subwoofer (S110 or S220).

Manual contents

This manual includes the instructions for the Final 300i, the Final 300i wall mountable panels and basic information about the Final subwoofer.

Please read and follow these instructions carefully before you connect your Final Sound system to your amplifier. These instructions are very important and will prevent you from experiencing any delay or system damage, which might occur in a trial and error situation.

The Final Sound product line consists of separate products, which can function individually or perform as a complete system.

4. Final Sound Model F300i floor standing loudspeakers

How to unpack the Final Sound F300i stereo system

The Final Sound Model F300i stereo system consists of two separate packaging units. The Model F300i flat-panel loudspeakers and the optional Final Sound subwoofer are packed separately.

(the 300i panels for the rear channels in home theatre applications are basically the same panels as the front loudspeakers. All unpacking and assembling instructions for the rear panels are identical to those for the stereo front panels)

The Model F300i Stereo flat-panel loudspeaker packaging contains:

- 2 Model F300i flat-panel loudspeakers (left and right)
- 2 power supplies 12VDC
- 2 footplate assemblies
- assembly materials including screws to fix the flat-panels on the footplates
- 1 manual

Each individual component is packed in its own carton. The easiest way to unpack is to open the upper side of the box (check the labels), take out the separate units and carefully remove the cartons and plastic bags. Take care to avoid putting pressure on the black loudspeaker's stator plates.

If your packaging is not complete, do not operate the system but contact your dealer.

We recommend you to save all packaging materials for possible later use.

If any unit appears to be damaged when unpacking, do not operate the damaged unit. Repack the unit in its original carton and notify your authorized Final Sound dealer immediately.

Assembling Model 300i

Assembling the Model300i floor standing panels is straightforward. The kit should contain:

- Two foot plates
- Two aluminum spacers
- 8 spikes
- 6 hexagon screws
- 1 Allen key

Just follow the pictures for assembling the 300i models.

What's in the 300i package?

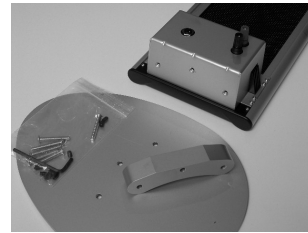

Position the three parts like this

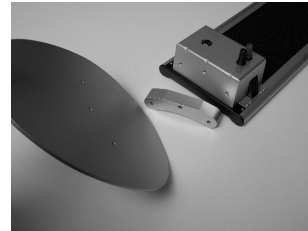

Put them together using the screws



Fix the screws firmly, using the Allen key

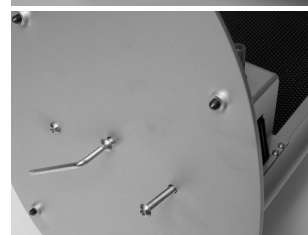

And then really tight

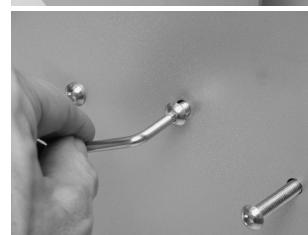

Mount the spikes or feet



The end result should be like this



What is the function of the Final Sound front and rear loudspeaker panels?

The Final Sound flat-panel front loudspeakers are the main channels in a stereo setting or a virtual surround system and have a dual role in a home theatre system. The front left and right loudspeakers, will handle the larger special effects, the musical score, and any left and right effects. The rear loudspeakers are used to create ambient effects. In a home cinema setting even actions occurring at the back of the listener will be reproduced. Both in a stereo configuration and a home theater configuration, the flat-panel loudspeakers function in close harmony with the Final Sound subwoofer.

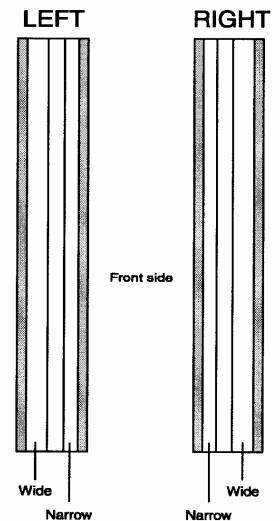

Where do I place the Final Sound loudspeaker panels?

There is a difference between a left (front/rear) and a right (front/rear) Final Sound loudspeaker panel. Each Final Sound loudspeaker panel is divided with two vertical spacers in three segments. The narrow strips have to be oriented to the inside. The difference is shown in the figure on this page.

To illustrate the best position for the loudspeaker panels we have to differentiate between Final Sound *Stereo* and Final Sound *Home Theatre* configurations. Please note that electrostatics are dipoles, i.e. the loudspeakers produce sound from both sides of the panels. This means an electrostatic loudspeaker should always be placed away from the wall and turned under a slight angle with the wall (not parallel with the wall).

Typical room layout

The figure represents a typical room set up for stereo and/or home theatre. The figure shows:

- The subwoofer's preferred positions, depending on the panels you choose.
- The base line between the front loudspeakers.
- The stereo loudspeaker's position.
- The full home theatre loudspeaker placement.
- The preferred position for the center loudspeaker.
- A preferred unequal distance between the side walls and the panels (a, b, c and d).

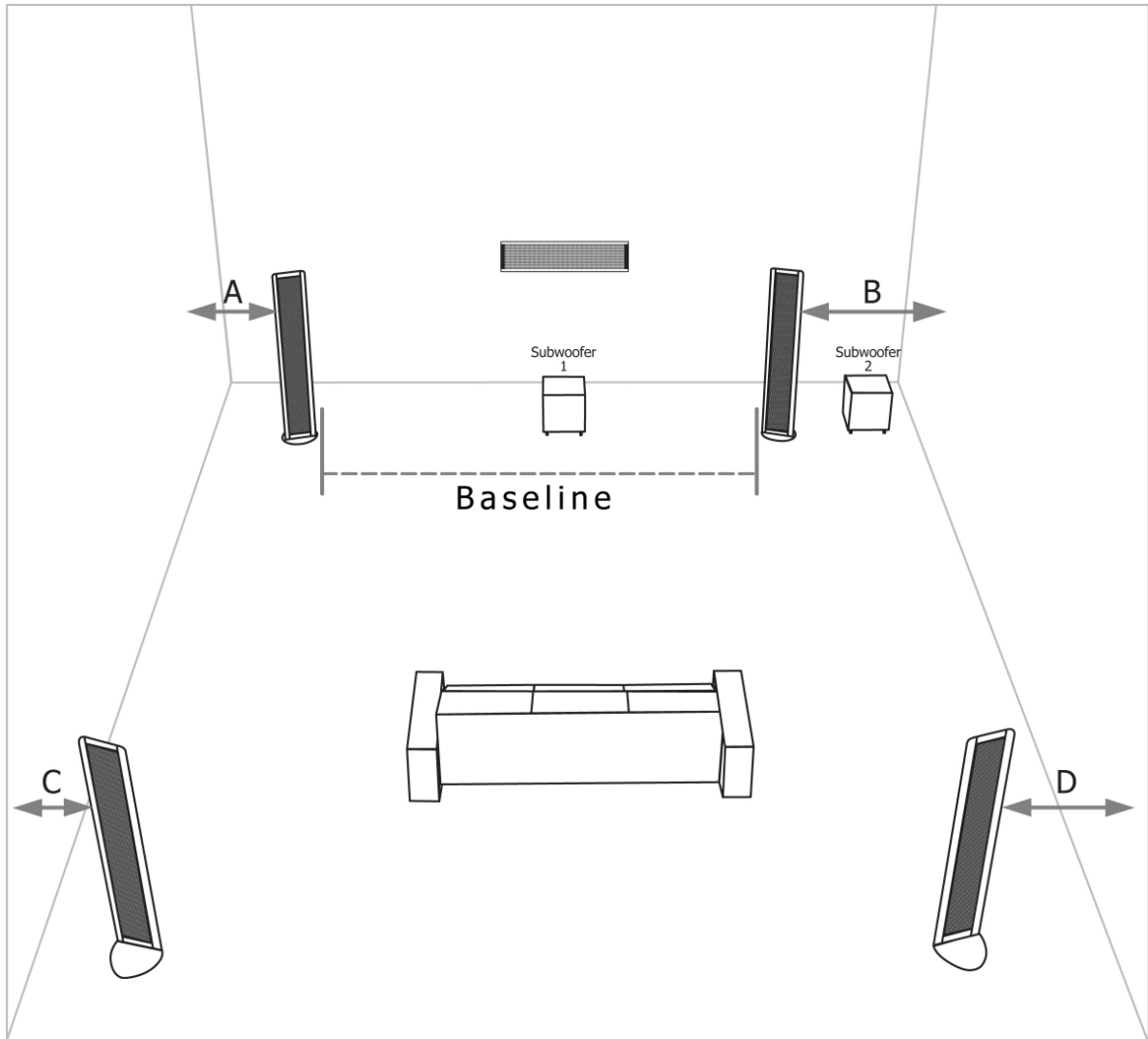

Application 1: The Final Sound home theatre configuration:

The Final Sound home theatre configuration consists of two front-loudspeakers, two rear/surround loudspeakers, a center loudspeaker and preferably our S110/S220 subwoofer. We recommend a symmetric positioning of the loudspeakers with respect to the screen, as to enhance the “home cinema experience”. Center loudspeaker and front loudspeaker panels should be located on the same horizontal axis. Sometimes it’s even better to place the center loudspeaker slightly further away than the front loudspeakers.

The surround or rear loudspeakers should be positioned adjacent to and slightly behind the primary listening area, on the rear wall or floor to provide a sense of spaciousness and ambience for all surround sound formats.

For the subwoofer’s instructions and placement, you can read more in the chapter ‘Final Sound subwoofer’.

Audio/Video receiver settings

The loudspeakers in the Final Sound home theatre system are designed to function in perfect harmony as a full range system together with the subwoofer. For an optimum performance your audio/video receiver settings are very important.

In terms of your audio/video receiver settings, the front-, rear- and center loudspeaker channels have to be set as SMALL satellites, when using the Model F300i flat-panel loudspeakers. How to install the optimal channel settings differs with the brands of the audio/video receivers and therefore we recommend reading the audio/video receiver manual or contact your dealer how to get the best settings in order to get the Real Final Sound out of your system.

Application 2: Final Sound stereo configuration:

The panels in a stereo setting (two front panels) are preferably located in a symmetrical way and away from the walls for optimum imaging. The panels need to point slightly towards the favorite listening position as you can see in the figure above. The other loudspeaker panels shown are not applicable in a stereo setting. For most of the Final panels you need a subwoofer.

Application 3: Final Sound virtual surround configuration:

For virtual surround, you only need two front panels, a subwoofer and a surround receiver with a virtual surround mode (e.g. Dolby Virtual or SRS). This mode, together with two loudspeakers, will present a kind of five channel emulation which will give you a very broad stereo stage just as in a movie theatre.

How do I connect the Final Sound loudspeaker panels safely?

The loudspeaker panels are labeled with an L (Left) and R (Right) code.

Each flat-panel loudspeaker panel comes with a 12VDC power supply, which has to be connected to the mains. It is necessary to connect the flat-panel loudspeakers to the mains; otherwise they won't function. The flat-panel loudspeakers are designed to stay on the mains permanently, however it is better to disconnect them during thunderstorms and when they will be not used for a long time.

The front and rear flat-panel loudspeakers are equipped with loudspeaker terminals, which are suited for spades or common loudspeaker wires. The red loudspeaker terminal has to be connected to the red terminal (+) on the audio/video receiver and the black terminal has to be connected to the black terminal (-) on the audio/video receiver.

Before connecting the front and rear loudspeaker panels, all sound system equipment should be disconnected from the mains. This will avoid the risk of damage to your system while connections are made or broken. If you experience any problems installing the flat-panel loudspeakers please contact your authorized Final Sound dealer.

How to clean and maintain the Final Sound loudspeaker panels?

Always unplug the Final Sound flat-panel loudspeakers from the mains and shut off all sound equipment before you start cleaning.

Dry clothe cleaning

Dry clothe cleaning is a weekly recommendation to wipe off dust. Cleaning on a regular base will prevent the insides of the panels to collect too much dust. To prevent fire or shock hazard, clean only with a DRY clothe and prevent pushing the black(sound producing) parts of the loudspeaker panels. Never use cleansers or chemicals or any liquids, which risk dripping into the loudspeaker panels. Using chemicals can harm the stator's protective cover. In that case, the panel does not approve to the safety regulations any more.

Vacuum cleaning

It's important to vacuum clean the panels once in two months. Switch off the panel's power and wait at least 15 minutes to start cleaning. Use a soft brush and don't apply too much air pressure to the panels. If the vacuum cleaner is very strong, keep some distance between the vacuum cleaner's brush and the panels. Vacuum clean both loudspeaker panels (both the front and back side).

5. Final Sound 300i wall mountable loudspeakers

How to unpack the Final Sound F300i wall mount stereo system

The Final Sound Model F300i wall mount stereo system consists of two separate packaging units. The Model F300i flat-panel wall mountable loudspeakers and the optional Final Sound subwoofer are packed separately.

(the 300i wall mountable panels for the rear channels in home theatre applications are basically the same panels as the front wall mountable loudspeakers. All unpacking and assembling instructions for the rear panels are identical to those for the stereo front panels)

The Model F300i stereo flat-panel wall mountable loudspeaker packaging contains:

- 2 Model F300i wall mountable flat-panel loudspeakers (left and right)
- 2 power supplies 12VDC
- Wall bracket kit and assembly materials
- 1 manual

Each individual component is packed in its own carton. The easiest way to unpack is to open the upper side of the box (check the labels), take out the separate units and carefully remove the cartons and plastic bags. Take care to avoid putting pressure on the black loudspeaker's stator plates.

If your packaging is not complete, do not operate the system but contact your dealer.

We recommend you to save all packaging materials for possible later use.

If any unit appears to be damaged when unpacking, do not operate the damaged unit. Repack the unit in its original carton and notify your authorized Final Sound dealer immediately.

Assembling Model 300i wall mountable

Assembling the Model 300i wall mountable panels is straightforward. The kit should contain:

- wall bracket kit
- 1 Allen key

Just follow the pictures for assembling the 300i wall mountable models.

You need the included wall bracket kit consisting off:

- 1 Allen key
- wall plate
- cover plate
- ball-bar
- 2 hexagon screws
- 4 screws and plugs

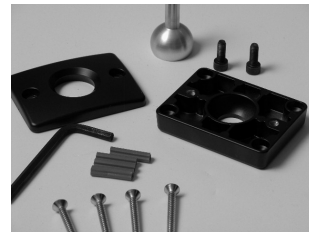

The 300i wall mountable is basically a 300i panel without floor standing support. The electronics housing is in the middle of the panel.

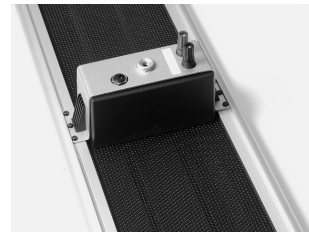

Mount the bracket's wall plate to the wall



Insert the ball-bar into the cover plate and screw the ball-bar into the loudspeaker's electronic housing

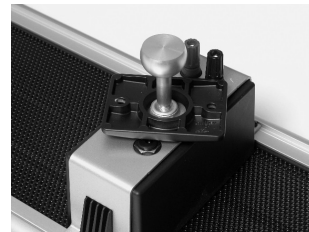

Mount the ball-bar firmly



Attach the panel to the bracket's wall plate, which was mounted earlier to the wall. You need the two hex bolts and the supplied Allen key for mounting the two parts together

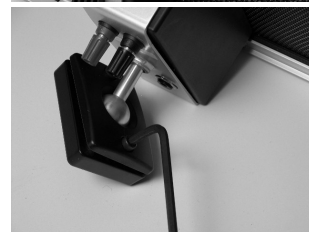

6. Final Sound center loudspeaker

For building a home theatre based on 300i using floor standing models, 300i wall mountable models or a combination, Final recommends a 300i center panel. Center panels can be wall mountable or fit to a table top stand.

How to unpack a Final Sound center panel?

A Final Sound center panel comes in one packaging unit.

A Final Sound center panel package contains:

- 1 center panel
- 1 power supply 12VDC
- assembly materials including screws to fix the flat-panels to the wall
- 1 manual
- a table top stand (included in the 300i package and optional for the 90i and 150i)

Each individual component is packed in its own carton. The easiest way to unpack is to open the upper side of the box(check the labels), take out the separate units and carefully remove the cartons and plastic bags. Take care to avoid putting pressure on the black loudspeaker's stator plates.

If your packaging is not complete, do not operate the system but contact your dealer.

We recommend you to save all packaging materials for possible later use.

If any unit appears to be damaged when unpacking, do not operate the damaged unit. Repack the unit in its original carton and notify your authorized Final Sound dealer immediately.

Assembling center panels

Assembling a center panel is straightforward. The kit should contain:

- wall bracket kit (the wall bracket is also used to fix the center panel to the table top stand)
- 1 Allen key

Just follow the pictures for assembling center panels.

The bracket's wall plate can be used to mount the loudspeaker to the wall or to fix the loudspeaker to the set top stand



Install the wall plate to the bracket



Install the bracket to the foot plate

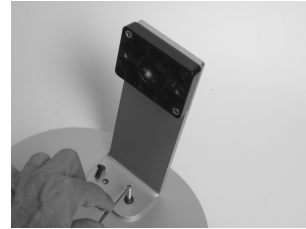

Insert the ball-bar into the cover plate and screw the ball-bar into the loudspeaker



Attach the panel to the set top stand

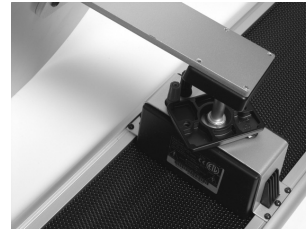

Adjust the speaker's position and firmly attach both screws



Attach the rubber pads to the footplate

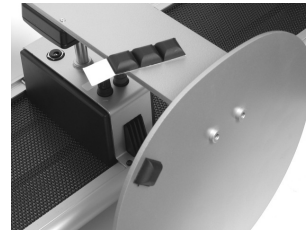

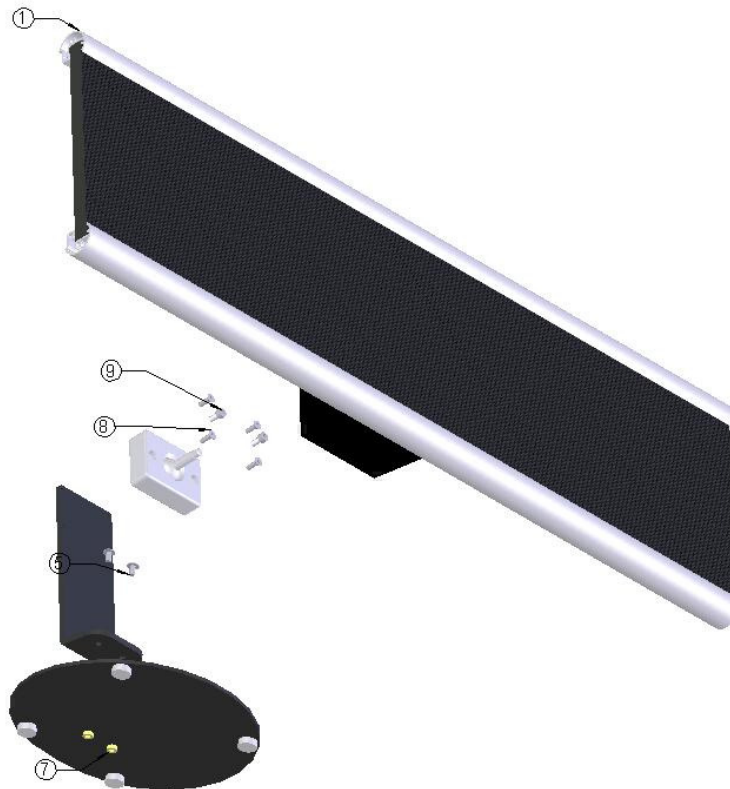

What is the function of a center loudspeaker?

The center channel in a home theatre system is responsible to keep the voices and some special effects locked on-screen. The Final Sound flat-panel center loudspeaker is a true line source, with a single loudspeaker element to deliver precise localization. The Final Sound flat-panel center loudspeaker is designed to function in harmony with the Final Sound subwoofer and the front and rear flat panels.

Application 1: Center panel in a Final Sound home theatre configuration:

The Final Sound home theatre configuration consists of two front-loudspeakers, two rear/surround loudspeakers, a center loudspeaker and a Final S110/S220 subwoofer. We recommend a symmetric positioning of the loudspeakers with respect to the screen, as to enhance the "home cinema experience". Center loudspeaker and front loudspeaker panels should be located on the same horizontal axis. Sometimes it's even better to place the center loudspeaker slightly further away than the front loudspeakers.

How do I connect the Final Sound center loudspeaker panels safely?

The center panel connects identically to the other panels in the system.

7. Final Sound subwoofer

How do I unpack the Final Sound subwoofer safely?

This package includes:

- One AC-power cord
- One Final Sound subwoofer
- One user manual for the subwoofer

If your package is not complete, do not operate the system but contact your Final Sound Dealer.

The easiest way to unpack is the following. Put the box on a flat surface on the ground. Open one side by cutting the tape carefully without damaging the contents of the box. You find the subwoofer in a plastic foil, with shock absorbing buffers positioned around the corners. Now carefully take out the subwoofer, please avoid touching the woofer unit positioned at the downside of the cabinet. We recommend saving all packaging materials for possible later use. Avoid touching the drive units.

If any unit appears to be damaged when unpacking, do not operate the damaged unit. Repack the unit in its original carton and notify your authorized Final Sound dealer immediately.

For further details please look at the manual supplied with the subwoofer.

Assembling subwoofers

The Final subwoofers arrive 'complete' assembled out of the box.



What is the function of the Final Sound subwoofer?

Both Final Sound subwoofers (S110/S220) are capable to reproduce music signals up to 200 Hz. This Final Sound subwoofers are designed to match perfectly with the characteristics of the Final Sound Model F300i flat-panel loudspeakers and belongs with the electronics and its perfect driver to the upper end of the subwoofer range. The Final Sound S110 subwoofer cabinet is provided with a down-firing driver and a build-in amplifier. The S220 subwoofer is provided with a front-firing driver and a build-in amplifier.

Where do I place the Final Sound subwoofer?

(For placement suggestions: see the figure in chapter 'Final Sound Model 300i front and rear loudspeakers')

Coloration, due to resonance, is strongest at bass frequencies between 20 and 200 Hertz. It's much easier to obtain high absorption at higher frequencies. So, the placement of a subwoofer is critical. Theoretically, the smoothest low-frequency response is obtained when the subwoofer is as close as possible to the listener's ears. The received sound from the subwoofer is then dominated by the direct radiation rather than by room resonances. Practically the subwoofer should be placed on the base line between the front panels. That's also advisable from a phase perspective and if the subwoofer outputs frequencies higher than 100Hz. You cannot locate frequencies below 100Hertz. If the output is above 100Hz, it's easy to locate the sound coming from the subwoofer. Then, it's common wisdom to keep the sub near the front panels and not along the wall or in the corner.

If you don't want to put the sub between the front panels and if the output is below 100Hz, the second best location is nearby the corner of the room, consistent with the acoustic theory that all the room modes will be excited evenly from this location. But, useful lessons learned from the real world tells us that the best approach in coping with subwoofers is to use your ears and play around a little bit.

How do I perform a safe subwoofer connection?

IMPORTANT: Before connecting the subwoofer, all sound system equipment should be disconnected from the mains until you have gone through all steps below. This will avoid the risk of damage to your system while connections are made or broken.



Warning: High voltage inside. To reduce the risk of fire or electric shock, do not expose this apparatus to rain or moisture.

The following connection schemes are the MOST COMMON for connecting subwoofers to the Final panels. The DEDICATED Final subwoofers will bring ADDITIONAL high pass filtering opportunities which are fully explained in the subwoofer's manual. We prefer to connect the panels using the high pass filtering in the dedicated Final subwoofer. It will bring a significant better performance.

CONNECTING FOR STEREO

(Figure 1) If you use an integrated stereo amplifier or stereo receiver.

- Connect the subwoofer's HI-LEVEL IN terminals to the amplifier's loudspeaker terminals (together with the electrostatic panels).
- You cannot use the subwoofer's special high pass filter facilities for driving the electrostatic panels.

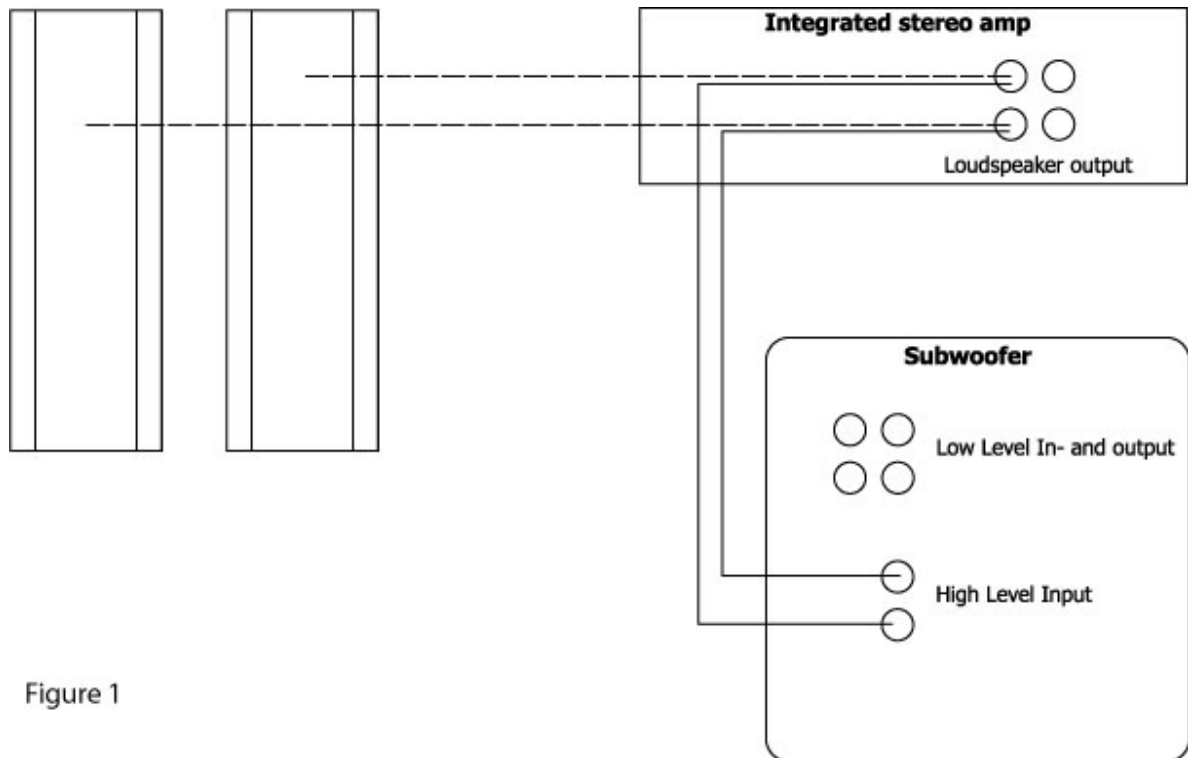

Figure 1

CONNECTING FOR HOME THEATRE

(Figure 2) If you have an AV-receiver for five, six or seven channel Dolby Digital/DTS surround sound, you can use the 'standard' LFE connection method for subwoofers.

- Connect the AV-receiver's LFE output to the subwoofer's left OR right LINE IN RCA terminal.
- Connect the five (six or seven) electrostatic panels to the five (six or seven) AV-receiver's loudspeaker output terminals.
- Adjust the 'loudspeaker size' in the receiver's menu to SMALL. This will activate the receiver's LFE output.
- If possible, adjust the crossover frequency between the panels and the subwoofer in the menu. Choose the panel's lowest frequency to start.
- You cannot use the subwoofer's special high pass filter facilities for driving the electrostatic panels.

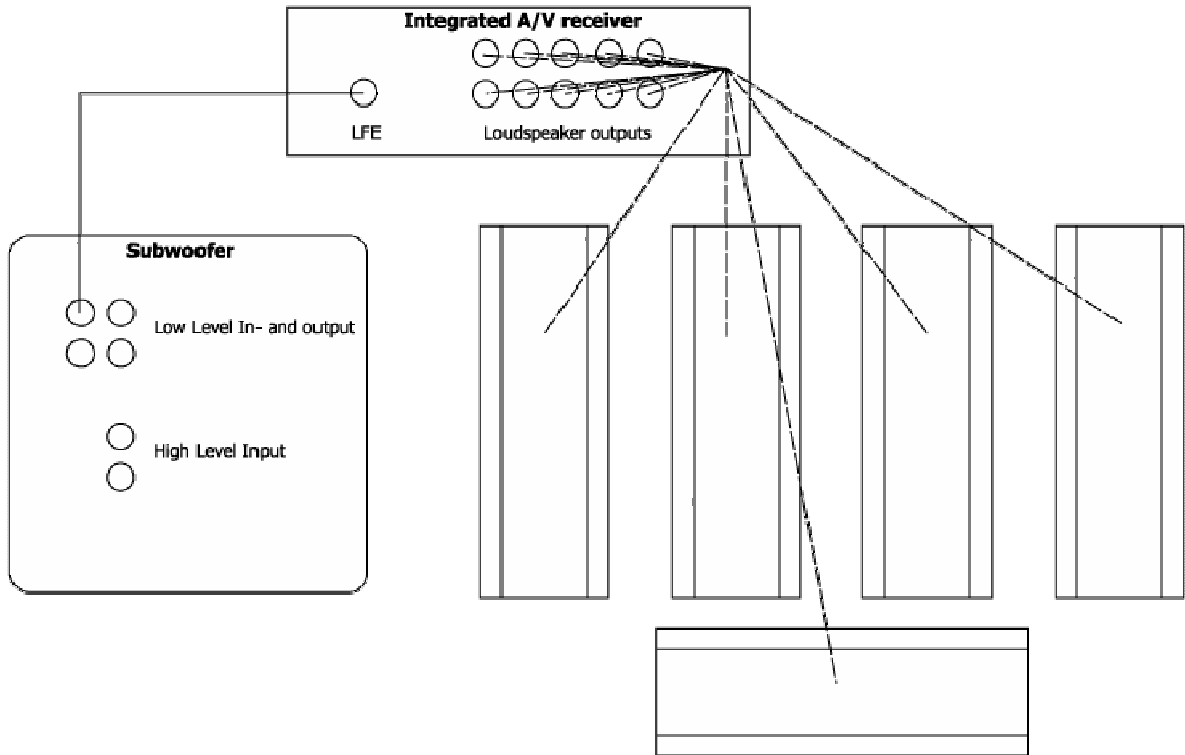

Figure 2

How to adjust a subwoofer

This procedure is valid for most subwoofers on the market and also for using the Final Sound subwoofer in 'standard mode'. For adjusting the Final Sound subwoofers in the special high pass mode, we refer to the dedicated subwoofer manuals.

- Position the subwoofer in the desired location.
- Connect the subwoofer according to this manual's instructions.
- Set the sub's volume control to a minimum and the phase switch (as a starting point) to 0 degrees.
- Adjust the Variable Phase control to 'minimum' (not every subwoofer in the market is equipped with a variable phase control).
- Adjust the sub's Low Pass control (crossover frequency) to the panel's lowest frequency (see Table 1).
- Keep the Variable Bass Equalizer at 'Min' (only for Final models).
- Play some music you are familiar with.
- Turn up the subwoofer volume to a level that matches the main loudspeaker's level.
- Now listen to modern music with some kind of strong bass rhythm.

- Adjust the Variable Phase control now. This is only necessary if the subwoofer's position is not on the baseline between the loudspeakers or left to the left loudspeaker and right to the right loudspeaker. If the subwoofer is before or behind the baseline, or somewhere else in the room, adjustment of the phase might be necessary. The Phase control is in the right position, if you're not aware of a time difference between the mid/high frequencies and the lower frequencies on the listening position. The system is definitely out of phase when the bass frequencies lag behind the rest of the spectrum or there's a time difference anyway. If it's not possible to get the right timing, reverse the Phase Switch from '0' to '180' and try again. If this is not helpful, diminish the distance between the subwoofer and the electrostatic panels.
- Readjust the volume control after adjusting the phase.
- You can slightly adjust the crossover frequency. You should be unaware that there's a crossover 'area'. There should be a seamless transition from the subwoofer to the panels. Use, as an example, piano music to make the right adjustment.
- Readjust the volume control again.
- If you have a dedicated stereo/surround setup guide/disc, refer to the directions included in it.
- Note that you may need to try more than one location for the subwoofer to reach optimum results.

TABLE 1 Recommended Crossover Settings

Model:	90i	150i	300i	400i	600i	1000i
Crossover setting:	150Hz	130Hz	95Hz	65Hz	45Hz	38Hz

Important information about dedicated Final subwoofers

The Final Sound subwoofers, are specially designed to match the requirements of the Final electrostatic loudspeaker. The crossover frequencies to several models Final electrostatic panels are programmed inside the subwoofer just as the time and phase behavior. So, contrary to common subwoofer's technology, the Final subwoofer is equipped with additional high pass filters for driving the electrostatic panels. Aside of this added feature, it's also possible to use these subwoofers in any other non Final stereo or home theatre system.

Using these subwoofers together with the Final electrostatic panels of your choice, needs a different approach when connecting your system.

Cross over frequency

The Final Sound Subwoofers covers the low frequency range up to 200Hz. While the F300i covers the frequency range from 95Hz up to 20Khz, it is important to define carefully the crossover frequency between the subwoofer and the electrostatic panels, which is influenced by the acoustic properties of the room and the placement of the subwoofer.

The dedicated subwoofer manual, included in the subwoofer packaging, will provide you with all the information about setting up and configuring the Final Sound subwoofers.

How to clean and maintain the Final Sound subwoofer

After switching the Final Sound subwoofer off, always unplug the subwoofer from the amplifier and disconnect the power cord before you start cleaning. To prevent fire or shock hazard, clean only with a damp cloth. Never use cleansers or chemicals. Never leave a wet cloth on the surface of the cabinet.

8. 300i specifications

300i specs

Frequency response: 95-22kHz +/- 3dB

Sensitivity: 86 dB (2.83 volts at 1 meter)

Impedance: nominal 4 ohm

Amplifier minimum: 40 Watt

Amplifier recommended: 60 Watt

Dimensions: 49.2 x 8.1 x 1 inch (125 x 20.7 x 2.5cm)

Dimensions (electronics housing): 7.1 x 2.8 x 2inch (18 x 7 x 5cm)

Weight: 17.64lbs. (8.0kg)

Mounts: floor Stand (standard)

 wall mount (optional)

Finish: satin silver with black (standard)

9. Frequently asked questions

Which is better, electrostatic or cone drivers?

You don't have to be a rocket scientist or a physicist to see that electrostatic drivers are very light and fast. In fact, the moving mass of an electrostatic panel is 1/30 the weight of a typical cone driver. For instance, the moving mass of the entire sounding surface of a model 90i is approx. 1 gram. This makes electrostatic drivers very fast in comparison with a lot of conventional designs. The result is obvious to all who listen to them. If a driver is light and fast, it can easily follow the so-called musical signal's 'envelope'. So the rise time (attack) of percussive signals and the decay are very fast and natural. As a result, an electrostatic driver will provide you with fast transients, greater clarity, detail, low level resolution and a marvellous stereo imaging.

How does the Final system work?

In a Final electrostatic driver, a thin conductive film (diaphragm) is suspended between two perforated "stator" assemblies. Spacers – the thin black lines that run down the surface – separate the film from the metal stators. The stators are insulated with a special paint and power is supplied to them by a DC (low voltage) source followed by a DC high voltage generator. The amplifier sends the audio signal via a transformer to the diaphragm, which it makes move to the front plate when the audio signal is positive and to the rear plate when it is negative. The moving diaphragm is coupled to the air and sound waves will reach our ears.

Because all the sound emerges from one single diaphragm, the sound keeps its phase relationship, resulting in a more realistic sound. A proper phase behaviour and the diaphragm's ability to follow the music's waveform very accurately (due to the diaphragm's minimal weight), adds to the impression of startling clarity, realism and a holographic imaging. Final electrostatic panels are also dipolar line arrays. The sound is radiating to the front and to the back, but basically out of phase. The advantage is that, due to noise cancellation, the panels do not radiate much sound to the sides. A dipole is less influenced by room acoustics and sounds more like the original recording did. The line array character also adds to the 'less room interaction behaviour'. Usually, line arrays do not enforce floor and ceiling reflexions.

What about the Inverter?

The Final electrostatic drivers are based on our patented Inverter technology. As most great ideas in history, the underlying principles are basically simple. A traditional electrostatic driver will put the high voltage to the membrane and the musical signal to the stators. In an Inverter based electrostatic driver, this is vice versa. The main advantage is that we can separate the diaphragm in pre-defined radiating areas for high, mid and low frequencies. When you can size radiating areas, you can also size the driver's radiating patterns. That's the main reason that our electrostatic loudspeakers do not have a 'hotspot'. They present a wide stereo image from nearly every listening position in the room.

What happened to the loudspeaker's enclosure?

There is an inherent relationship between dynamic drivers and enclosures. The enclosure's shape, volume and size are important supporting parameters to accomplish a specified performance level from dynamic systems. So between dynamic drivers and enclosures are almost mathematical dependencies. Basically, a dynamic driver is designed to operate in an enclosure.

Electrostatic drivers don't need enclosures. The only reason for finding enclosed electrostatic loudspeakers has to do with electrical safety. Due to our patented Inverter technology, Final electrostatic panels don't need enclosures for electrical safety reasons. Getting rid of enclosures is pretty cost effective and it translates into a reasonable consumer price. Since the speaker cabinet is the most expensive part in most of the dynamic systems (woofers, tweeters, and crossovers are usually less than 30% of the materials cost of a typical box speaker). Because there is no cabinet, Final electrostatic loudspeakers do not have any cabinet induced coloration and sound very neutral.

How much power do you need?

The simplicity of the Final Inverter Technology enables the loudspeaker's impedance to remain well above 4 ohms across the entire frequency spectrum. This allows the use of smaller amplifiers - as low as 35 watts - to drive the loudspeakers. Most high-performance electrostatic loudspeakers required

more powerful and expensive amplifiers with 100-200 watts per channel to cope with very low impedances.

Although our loudspeakers will work fine with the majority of reasonably priced amplifiers from 35 Watt/channel and up, we also know that our panels will benefit when driven by high powered quality amps. This knowledge is not limited to the use of electrostatic loudspeakers but is true for any loudspeaker in the market. Exceptions are the high sensitive loudspeakers which you can drive with low powered triode and other tube amplifiers. But this belongs to the exclusive domain of audiophile knowledge and the ultimate dedication towards sound quality. To complete this chapter; room size and room acoustics have something to do with this equation as well. Bigger rooms need more power, smaller rooms less. Rooms with lots of absorption from drapes and furniture need more power; reflective rooms less.

How large are the panels? Is there a special model for a center channel?

The panels come in a range of sizes from 20" tall to 80" tall for front and rear channel use. The center panels range from 21" to 48" and can only be used in a horizontal position. The center panel includes a separate vertically aligned tweeter assembly that extends the vertical response of the center channel to 60 degrees off axis.

The Model 90i, 150i, 300i can be floor standing or wall mounted. The larger panels are designed primarily as floor-standing loudspeakers. The wall brackets are included in the price for the 90i and 150i and the 300i wall mountable models. Floor stands are included with the larger models. The panels are sized to match the height of the most popular selling brands of plasma TV between 32" and 60" diagonal.

Where should I place my subwoofer?

Coloration, due to resonance, is strongest at bass frequencies between 20 and 200 Hertz. It's much easier to obtain high absorption at higher frequencies. So, the placement of a subwoofer is critical. Theoretically, the smoothest low-frequency response is obtained when the subwoofer is as close as possible to the listener's ears. The received sound from the subwoofer is then dominated by the direct radiation rather than by room resonances. Practically, the subwoofer should be placed on the base line between the front panels. That's also advisable from a phase perspective and if the subwoofer outputs frequencies higher than 100Hz. You cannot locate frequencies below 100Hertz. If the output is above 100Hz, it's easy to locate the sound coming from the subwoofer. Then, it's common wisdom to keep the sub near the front panels and not along the wall or in the corner.

If you don't want to put the sub between the front panels and if the output is below 100Hz, the second best location is nearby the corner of the room, consistent with the acoustic theory that all the room modes will be excited evenly from this location. But, useful lessons learned from the real world tells us that the best approach in coping with subwoofers is to use your ears and play around a little bit. Can I mix and match the Final panels and subwoofers?

Our lines of loudspeakers and subwoofers are modular, scalable and customisable. Basically, we do have a line for home theatres and a line for professionals and most discriminating audio consumers. The home theatre packages will bring you five panels in one box and additional subwoofers and optional floor stands. But, because we're modular and customisable, nothing stops you to design your own home theatre configuration, using any combination of Final panels you like. Stereo-systems and home theatres are also scalable. Depending on your room's sizes, you can build a system with small panels, but also head towards a theatre consisting of five large 600 electrostatics. It's all up to you and your dealer might give you some good advice. The Final family of electrostatics is arguably the most flexible offering in the world.

What are the key features of Final electrostatic loudspeakers?

The Inverter technology represents a major breakthrough in electrostatic loudspeaker design. High resolution and detail: The diaphragm's combination of low mass together with instant acceleration and deceleration, will bring a very natural and fast reproduction of the audio signal.

Huge stereo stage: The application of the patented inverter technology will bring a wide stereo stage, without the 'hot spot' traditional electrostatic loudspeakers are known for.

Easy amplifier match: The inverter technology will raise the impedance to values comparable with most dynamic loudspeakers in the market. You can drive any Final electrostatic loudspeaker with any good amplifier, delivering between 35-100 watt power.

Sound: Final electrostatic loudspeakers do have a low distortion, good dynamic behaviour, neutrality, speed, clarity and low level resolution.

Design: Final electrostatic loudspeakers are basically elegant flat panels and they combine perfectly with flat panel screens and televisions.

Any size: The Final family of electrostatic loudspeakers starts with small high definition panels for smaller rooms and customers on a tight budget. The smaller models do have the same sonic qualities as the larger panels.

Modular and flexible: Although Final Sound can provide you with standard home theatre packages, you can basically build theatre and sound systems with any combination of panels. It can suit your tastes, your room size and your budget.

Specially designed subwoofers: Most of our electrostatic loudspeaker panels need a subwoofer. Final Sound offers a family of subwoofers which are matched perfectly in terms of speed, articulation, dynamic behaviour and power output.

Placement: depending on the panel's size and application, we deliver footplates, floor stands, set tops and wall mounts.

Does a Final Sound flat-panel loudspeaker get dirty?

Yes it does, just as every other object in your room, but it depends for a great deal on the place where the loudspeakers are situated. Next to the fireplace or the kitchen are places we do not recommend. You should appreciate that a Final Sound electrostatic loudspeaker is not covered, because that would be detrimental to the sound. Come to that, a little dust is not a problem since the stators can easily be cleaned with a vacuum cleaner (see instructions in this manual).

What about funny noises your flat-panel loudspeakers might produce?

Funny noises can occur sometimes when you listen closely to the panels. These are normal to electrostatic loudspeakers in general, and are absolutely harmless. These do not affect the loudspeaker or the audio-system. Whether circumstances are mostly responsible for any electrostatic loudspeaker producing some noises.

How long does a Final Sound flat-panel loudspeaker last?

Electrostatic loudspeakers have been on the market since 1935, although materials allowing for an optimization of the technology have only become available in the last 10 years. Final Sound uses diaphragms that last a great many years. Final Sound is constantly involved in research to further improve its technology.

Could my children, pets, or myself be shocked by the high-voltage present in the flat-panel loudspeakers?

No. Whilst your Final Sound loudspeaker systems are indeed connected to a power supply, they have excellent insulation. When you remove your sweater in the winter, its electrostatic charge will be considerably greater than the charge on the diaphragm in a Final Sound loudspeaker. But of course, you should not open the loudspeaker, nor repair them. Only your authorized Final Sound service technician, who is professionally trained in the workings of all Final Sound products, should carry out this work. We stress not to touch any product that is connected to the power supply, during operation.

Will excessive smoke or dust cause any problems?

Exposure to excessive contaminants, such as smoke or dust, may potentially affect the performance of the electrostatic diaphragm and may cause discoloration of the diaphragm. Dirt and dust may be removed by means of a soft brush attached to your vacuum cleaner. See the vacuum cleaning instructions in this manual.

Are Final Sound front and rear flat-panel loudspeakers to be treated as satellites?

Yes, they have to be installed as satellites on your audio/video receiver or multi channel amplifier. The correct settings are "SMALL satellites" for the Model F300i flat-panel loudspeakers, which correlates with the frequency range of the loudspeaker output.

Should I unplug my Final Sound home theatre system during lightning?

Yes. Unplugging before the storm is even better. It's a good idea to disconnect all of your audio/video components during stormy weather.

What is to be done when puncturing, knocking over or come in contact with fluids and fire damages the Final Sound loudspeakers?

Unplug your Final Sound loudspeaker and contact your Final Sound dealer.

Why do I need a Final Sound subwoofer?

The Final Sound home theater is based on the 5+1 multi channel amplifiers, which require two front loudspeakers, two rear loudspeakers, one center loudspeaker and a subwoofer.

The subwoofer will produce the lowest frequencies when necessary and is designed to function in harmony with the other Final Sound loudspeakers.

Also, most of our electrostatic panels need a subwoofer for reproducing the lowest frequencies.

What are the roles of the six loudspeakers in a home theatre system?

Your main channels, e.g. the left and right loudspeakers, will handle the larger special effects, the musical score, and any left and right effects.

The center channel will handle almost all the dialogue as well as 60-70% of the main action on the screen.

The rear channels are for ambient effects or to recreate different settings, as well as the screen action that is recorded to happen at the rear of the listener.

The subwoofer handles the extremely low frequencies such as the explosions in an action film or the deepest rumble of a bass drum.

What is "timbre matching"?

This means that all of the loudspeakers in a home theater system have the same sound characteristics or voicing. This allows for a smooth, convincing transitions between left, center, right, and rear/surround channels.

Are Final loudspeakers suitable for Dolby Digital AC-3, DTS, etc.?

Yes. Final loudspeakers are very accurate to be used with any decoding system designed for the home theater.

What is the warranty?

Your Final Sound Home theatre system can be provided with limited 3-year warranty coverage on the flat-panel loudspeakers and 1-year warranty coverage on the subwoofer if the registry card in the manual is completed and returned to Final Sound. The limited warranty will not be honored when the product has been used or handled other than in accordance with the instructions in the user manual. See for more details the chapter Warranty Conditions in this manual.

Is a Final loudspeaker protected against overloading?

Basically: yes. The design of the Final Inverted series of electrostatic loudspeakers has been done with the protection of the user in mind and the protection of the loudspeaker against mistreatment. The design has several levels of protection built into the electronics. One of those circuits protects against overloading. In case of an overload condition, the loudspeaker will shut off for a short period of time. If the overload condition is persistent, please reduce the volume of the amplifier. But, protecting a loudspeaker is always a trade off between simply cutting off musical information and allowing dynamics

to surpass reasonable sound levels. Before serious damage can be done, every loudspeaker will first give a clear warning signal by means of severe audible distortion. That's the moment to lower the volume. If the state of overloading (and severe audible distortion) will continue, serious damage to the panels can occur. Because of the protection circuit's 'trade off' behavior, we do not guarantee that this circuit will protect the loudspeaker against all possible kinds of mistreatment. Damage resulting from such mistreatment is not covered by our warranty conditions.

Where can I find more information about Final Sound?

For any questions about Final Sound or about installing your loudspeakers, contact your Final Sound dealer or visit our website at www.finalsound.com.

10. Warranty

Automatic Coverage

Thank you for purchasing this Final Sound product. We have made every effort to insure that it represents the highest level of performance, reliability and finish. A Limited Ninety Day Warranty covers your Final Sound product. This ninety-day coverage is automatic upon your acceptance of delivery and no registration is required.

Free Extended Warranty Coverage

Additionally, you have the option, at no cost to you, to secure extended warranty coverage for a period of three years from the date of purchase by the original purchaser by simply returning this completed Limited three Year Warranty Registration Card and a photocopy of your original purchase receipt to Final Sound within thirty days of product delivery.

Limited Ninety Day Warranty

Final Sound, warrants the product designated herein to be free of manufacturing defects in material and workmanship, subject to the conditions hereinafter set forth, for a period of ninety (90) days from the date of purchase by the original purchaser.

Conditions

This warranty is subject to the following conditions and limitations: the warranty is void and inapplicable if the product has been used or handled other than in accordance with the instructions in the owner's manual, abused or misused, damaged by accident or neglect or in being transported, or the defect is due to the product being repaired or tampered with by anyone other than Final Sound or an authorized Final Sound dealer. If returned, the product must be properly packaged and shipped to Final Sound or an authorized Final Sound dealer by the customer at his or her sole expense. A returned product must be accompanied by a written description of the defect and proof of the date of purchase. Final Sound reserves the right to modify the design of any product without obligation to purchaser of previously manufactured products and to change the prices or specifications of any product without notice or obligation to any person.

Exclusions

Any implied warranties relating to the above product shall be limited to the duration of the above warranty. The warranty does not extend to any incidental or consequential costs or damages to the purchaser. Some countries do not allow limitations on how long an implied warranty lasts or exclusion or limitation of incidental or consequential damages, so the above limitations or exclusions may not apply to you. This warranty gives you specific legal rights, and you may also have other rights, which vary from country to country. This warranty represents a limited warranty as defined above.

Optional Limited Three Year Warranty

Upon receipt of the completed Limited Three Year Warranty Registration Card and copy of the original purchase receipt, the registered product will carry the following warranty coverage:

Limited Warranty

Final Sound warrants the product designated herein to be free of manufacturing defects in material and workmanship, subject to the conditions hereinafter set forth, for a period of three years from the date of purchase by the original purchaser.

Conditions

This warranty is subject to the following conditions and limitations. The warranty is void and inapplicable if the product has been used or handled other than in accordance with the instructions in the owner's manual, abused or misused, damaged by accident or neglect or in being transported, or the defect is due to the product being repaired or tampered with by anyone other than Final Sound or an authorized Final Sound dealer. If returned, the product must be properly packaged and shipped to Final Sound or an authorized Final Sound dealer by the customer at his or her sole expense. A written description of the defect and a photocopy of the validated warranty must accompany a returned product. Final Sound reserves the right to modify the design of any product without obligation to purchasers of previously manufactured products and to change the prices or specifications of any product without notice or obligation to any person.

Remedy

In the event the product fails to meet the above Warranty and the above conditions have been met, the purchaser's sole remedy under this Limited Warranty shall be to return the product to Final Sound or an authorized Final Sound dealer where the defect will be rectified without charge for parts or labor.

Restriction

This Warranty is for the sole benefit of the original purchaser of the covered product, is restricted to the original purchaser, and shall not be transferred to a subsequent purchaser of the product.

Duration

This Warranty expires on the third anniversary of the date of purchase. During the first ninety (90) days following the date of purchase by the original purchaser, the Final Sound Limited Ninety Day Warranty supersedes this Warranty.

Exclusions

Any implied warranties relating to the above product shall be limited to the duration of the above warranty. The warranty does not extend to any incidental or consequential costs or damages to the purchaser. Some countries do not allow limitations on how long an implied warranty lasts or exclusion or limitation of incidental or consequential damages, so the above limitations or exclusions may not apply to you. This Warranty gives you specific legal rights, and you may also have other rights, which vary from country to country. This Warranty represents a limited warranty as defined above.

11. Limited Warranty Registration Card

In order to validate your warranty registration we kindly ask you to fill in the following data. For registration, this form has to be accompanied by a copy of your purchase receipt. We thank you and wish you great enjoyment with your new Final Sound product.

Name: _____
Email: _____
Address: _____
City: _____ .State _____
Country: _____
Authorized Final Sound dealer: _____
Salesperson's Name: _____

Please fill in for warranty registration the serial numbers of all units you have bought.
(Numbers appear on labels at the back of the product)

1 Final Sound Center Loudspeaker: _____
1 set Final Sound Front Loudspeakers (Home Theatre or Stereo System, 2 panels): _____
1 set Final Sound Rear Loudspeakers (2 panels): _____
1 Final Sound Subwoofer: _____

To improve our products and customer service, we would greatly appreciate your answers to the following questions.

Title or profession: _____ Age: _____

How did you find out about Final Sound? _____

Advertisement in _____

Relations/friends _____

Internet: _____

Other _____

What kind of amplifier do you use?

Brand: _____

Type: _____

If you have any comments on our products and services, please use the back of the form.
Thank you very much for taking time to complete in this form and sending it to:

Final Sound Eisenhowerweg 8D 5466 AC Veghel The Netherlands

For US customers ONLY:

Final Sound, L.L.C. 500 West Cummings Park, Suite 2500 Woburn, MA 01801 T:(781) 938-6416 F:(781) 938-6415

© 2007 Final Sound

