



NFD 2544

User's manual

Dear customer,

Thank you for having chosen our induction ceramic hob.
In order to make the best use of your appliance, we would advise you to read carefully the following notes and to keep them for a later consulting.

SUMMARY

SAFETY	15
PRECAUTIONS BEFORE USING.....	15
USING THE APPLIANCE	15
PRECAUTIONS NOT TO DAMAGE THE APPLIANCE	16
PRECAUTIONS IN CASE OF APPLIANCE FAILURE.....	16
OTHER PROTECTIONS	16
DESCRIPTION OF THE APPLIANCE	17
TECHNICAL DATA.....	17
CONTROL PANEL	17
USE	17
SENSITIVE TOUCHES.....	17
DISPLAY	17
VENTILATION.....	18
STARTING-UP AND APPLIANCE MANAGEMENT	18
BEFORE THE FIRST USE.....	18
INDUCTION PRINCIPLE	18
STARTING-UP	18
RESIDUAL HEAT INDICATION.....	18
TIMER	19
CONTROL PANEL LOCKING.....	19
COOKING ADVICE	20
SETTING UP THE COOKING LEVELS / TEMPERATURES	20
MAXIMUM TEMPERATURE AND « SMOKING POINT »	20
COOKING ADVICE	20
MAINTENANCE AND CLEANING	21
GLASS CLEANING	21
COOKING SURFACE CLEANING	21
WHAT TO DO IN CASE OF A PROBLEM	22
ENVIRONMENT PROTECTION	22
INSTALLATION INSTRUCTIONS	23
ELECTRICAL CONNECTION	24

SAFETY

Precautions before using

- Unpack all the materials.
- The installation and connecting of the appliance have to be done by approved specialists. The manufacturer can not be responsible for damage caused by building-in or connecting errors.
- To be used, the appliance must be well-equipped and installed in a kitchen unit and an adapted and approved work surface.
- This domestic appliance is exclusively for the cooking of food, to the exclusion of any other domestic, commercial or industrial use.
- Remove all labels and self-adhesives from the ceramic glass.
- Do not change or alter the appliance.
- The cooking plate can not be used as freestanding or as working surface.
- The appliance must be grounded and connected conforming to local standards.
- Do not use any extension cable to connect it.
- The appliance can not be used above a dishwasher or a tumble-dryer: steam may damage the electronic appliances.

Using the appliance

- This appliance can only be used for a domestic use for cook, fry and grill the foods.
- Switch the heating zones off after using.
- Keep an eye on the cooking using grease or oils: that may quickly ignite.
- Be careful not to burn yourself while or after using the appliance.
- Make sure no cable of any fixed or moving appliance contacts with the glass or the hot saucepan.
- Magnetically objects (credit cards, floppy disks, calculators) should not be placed near to the engaged appliance.
- Do not place any metallic object except heating containers. In case of untimely engaging or residual heat, this one may heat, melt or even burn.
- Never cover the appliance with a cloth or a protection sheet. This is supposed to become very hot and catch fire.
- This appliance is not intended for use by persons (including children) with reduced physical, sensory or mental capabilities, or lack of experience and knowledge, unless they have been given supervision or instruction concerning use of the appliance by a person responsible for their safety.
- Children should be supervised to ensure that they do not play with the appliance.
- Metallic objects such as knives, forks, spoons and lids should not be placed on the hob surface since they can get hot.
- Do not use this appliance to heat a room.
- Take away any inflammable material from the appliance (plastic, aluminium paper, tissue,...). However if some object should be in contact with the warm surface, take it away with a spatula.
- The appliance could be noisy during the running. That's not a functioning problem and don't disturb the performance of the appliance.

Precautions not to damage the appliance

- Raw pan bottoms or damaged saucepans (not enamelled cast iron pots,) may damage the ceramic glass.
- Sand or other abrasive materials may damage ceramic glass.
- Avoid dropping objects, even little ones, on the vitroceramic.
- Do not hit the edges of the glass with saucepans.
- Make sure that the ventilation of the appliance works according to the manufacturer's instructions.
- Do not put or leave empty saucepans on the vitroceramic hobs.
- Sugar, synthetic materials or aluminium sheets must not contact with the heating zones. These may cause breaks or other alterations of the vitroceramic glass by cooling: switch on the appliance and take them immediately out of the hot heating zone (be careful: do not burn yourself).
- Never place any hot container over the control panel.
- If a drawer is situated under the embedded appliance, make sure the space between the content of the drawer and the inferior part of the appliance is large enough (2cm). This is essential to guaranty correct ventilation.
- Never put any inflammable object (ex. sprays) into the drawer situated under the vitroceramic hob. The eventual cutlery drawers must be resistant to heat.

Precautions in case of appliance failure

- If a defect is noticed, switch on the appliance and turn off the electrical supplying.
- If the ceramic glass is cracked or fissured, you must unplug the appliance and contact the after sales service.
- Repairing has to be done by specialists. Do not open the appliance by yourself.
- **WARNING:** If the surface is cracked, switch off the appliance to avoid the possibility of electric shock.

Other protections

- For the users of pacemaker, the magnetic field could influence its operating. We recommend getting information to the retailer or of the doctor.
- Do not to use aluminium or synthetic material containers: they could melt on still hot cooking zones.

DESCRIPTION OF THE APPLIANCE

Technical data

Type	Total Power	Heating zone location	Nominal Power*
7325440	2800W	Front Rear	1400W 1400W

* Average measured power

Control panel

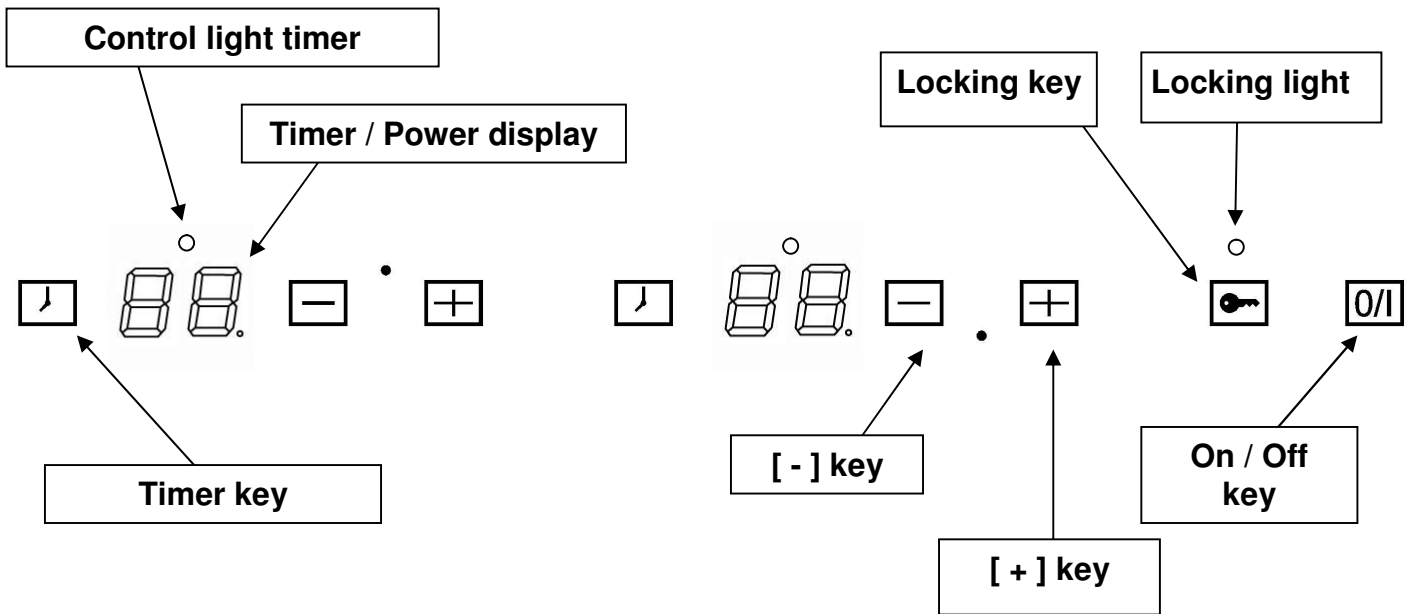

USE



Sensitive touches

Your ceramic hob is equipped with electronic controls with sensitive touch keys. When your finger touches the key, the corresponding command is activated. This activation is validated by a control light, a letter or a number in the display and/or a “beep” sound.

Touch only one key on the same time.

Display

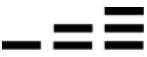
Display

0
1...9
E
H



Designation

Zero
Power level
Error message
Residual heat
Dynamic temperature level
Dynamic temperature level
Dynamic temperature level

Function

The heating zone is activated
Selection of the cooking level
Electronic failure
The heating zone is hot
Temperature increase
Temperature decrease
Temperature is reach

Ventilation

The cooling system is fully automatic. The cooling fan starts with a low speed when the calories brought out by the electronic system reach a certain level. The ventilation starts his high speed when the hob is intensively used. The cooling fan reduces his speed and stops automatically when the electronic circuit is cooled enough.

STARTING-UP AND APPLIANCE MANAGEMENT

Before the first use

Clean your hob with a damp cloth, and then dry the surface thoroughly. Do not use detergent which risks causing blue-tinted colour on the glass surface.

Induction principle

An induction coil is located under each heating zone. When it is engaged, it produces a variable electromagnetic field which produces inductive currents in the ferromagnetic bottom plate of the pan. The result is a heating-up of the pan located on the heating zone.

Starting-up

- **Start-up/ switch off the hob :**

<u>Action</u>	<u>Control panel</u>	<u>Display</u>
To start	Press key [0/I]	[0]
To stop	Press key [0/I]	nothing or [H]

- **Start-up/ switch off the heating zone :**

To turn on the hob press first the [0/I] key, then the desired heating zone press [+]:

<u>Action</u>	<u>Control panel</u>	<u>Display</u>
Increase power	Press key [+]	[4] to [9]
Decrease power	Press key [-]	[9] to [1]
Stop	Press simultaneous [+] and [-]	[0] or [H]

Residual heat indication

After the switch-off of the hob, the heating zone is still hot and indicates [H] on the display. The symbol [H] disappears when the heating zone may be touched without danger. As far as the residual heat indicator is on light, don't touch the heating zone and don't put any heat sensitive object on them. There are risks of burn and fire.

Timer

The timer is able to be used with a time setting from 0 to 99 minutes.

- **Setting and modification of the cooking time**

<u>Action</u>	<u>Control panel</u>	<u>Display</u>
To select the heating zone	Press key [+]	The zone control light is on
To select the power level	Press key [+] or [-]	[1] ... [9]
To select « Timer »	Press key []	The time displays [00]
Increase the time	Press key [+]	The time increases...
Decrease the time	Press key [-]	The time decreases...

After a few seconds the control light stops with blinking.

The time is confirmed and the cooking starts until the time reaches [00].

- **To stop the cooking time**

<u>Action</u>	<u>Control panel</u>	<u>Display</u>
To select « Timer »	Press key []	The remaining time
To stop the « Timer »	Press key [-] and [+] Or press [0/I]	Displays [00] then stops

As soon as the selected cooking time is finished the timer displays blinking [00] and a sound rings.

To stop the sound and the blinking it is enough to press the key []

- **Egg timer function**

<u>Action</u>	<u>Control panel</u>	<u>Display</u>
Activate the hob	Press key [0/I]	The zone control light is on
Select« Timer »	Press key []	Time [00] minutes
Increase the time	Press key [+]	The time increases
Decrease the time	Press key [-]	The time decreases

After a few seconds the control light stops with blinking.

As soon as the selected cooking time is finished the timer displays blinking [00] and a sound rings.

To stop the sound and the blinking it is enough to press the key [].

Control panel locking

To avoid modifying a setting of cooking zones , in particular with within the framework of cleaning the control panel can be locked (with exception to the On/Off key [0/I]).

- **Locking**

<u>Action</u>	<u>Control panel</u>	<u>Display</u>
Start	Press key [0/I]	[0] or [H]
Wok locking	Press []	Locking light on

- **Unlocking**

<u>Action</u>	<u>Control panel</u>	<u>Display</u>
Unlocking the Wok	Press []	[0] or [H]

COOKING ADVICE

Setting up the cooking levels / temperatures

Cooking levels	Temperature (°C)
1	50
2	75
3	100
4	125
5	150
6	170
7	190
8	205
9	220

You can cook directly on the heating surface with or without fat (oil or grease)

Avoid reaching the « smoking point » (too high temperature) when you are cooking with oil or fat. Food will lose its nutritive value.

In order to conserve all the flavour and quality, be sure to adjust the right temperature in accordance with the type of cooking required.

Maximum temperature and « smoking point »

Grease / Oil	Maximum recommended temperature (°C) / power	Smoke point (°C)
Butter	130 / 4	150
Lard	170 / 6	200
Beef fat	180 / 6	210
Olive oil	180 / 6	200
Sunflower oil	200 / 7	220
Peanut oil	200 / 7	235
Coconut oil	200 / 7	240

Cooking advice

Type of foods	Temperature (°C)	Power
Fish and seafood	170-180	6
Veal	160-180	6
Beef	200-210	8
Pork	180-210	7
Lamb	180-200	7
Poultry	160-180	6
Sausage	200	7-8
Fried egg	140	4-5
Pancake / omelette	140-160	5
Fruits	140-160	5
Vegetables	140-160	5
To simmer rice previously cooked	140-160	5
To simmer Pasta previously cooked	140-160	5

MAINTENANCE AND CLEANING

Glass cleaning

Clean the control panel using a little washing up liquid diluted in water or a recommended commercial vitroc ceramic product.

Highly corrosive or abrasive detergents and cleaning equipment likely to cause scratches must be avoided at all costs.

Dry the appliance with a clean rag.

Spillages of sugar, jam, jelly, etc. must be removed immediately.

Cooking surface cleaning

Cold cooking surface: Remove light marks with a damp cloth using washing up liquid diluted in a little water. Then rinse with cold water and dry the surface thoroughly with movements that follow the natural grooves of the cooking surface (no circular movements).

Warm cooking surface: Switch-off the appliance and let it cool to 90°C (level 2)

Put icicles on the cooking surface and remove light marks with a spatula and push them into the drain. Clean the drain with absorbent paper for example. Cold water can replace the icicles.

Then dry the surface thoroughly with movements that follow the natural grooves of the cooking surface (no circular movements) with a clean rag.

Some marks that come from acid naturally contained in food can be cleaned with lemon juice when the appliance is cold.

Do not clean the hob if the glass is too hot: risk of burn.

Highly corrosive or abrasive detergents and cleaning equipment likely to cause scratches must be avoided at all costs.

Never use any steam-driven or pressure appliances.

WHAT TO DO IN CASE OF A PROBLEM

The hob or the cooking zone doesn't start-up

- The hob is badly connected on the electrical network.
- The protection fuse cut-off
- The locking function is activated
- The sensitive keys are covered of grease or water.
- An object is put on a key.

The symbol [E] displays

- Disconnect and replug the hob.
- Call the After-sales Service.

One or all cooking zones cut-off

- The safety system functioned
- You forgot to cut-off the cooking zone for a long time.
- One or more sensitive keys are covered.
- The pan is empty and its bottom overheated.
- The appliance has an automatic reducing system of the power level and an automatic cut-off system when there is overheating.

Continuous ventilation after cutting-off the hob

- This is not a failure, the fan continuous to protect the electronic device.
- The fan cooling stops automatically.

ENVIRONMENT PROTECTION

- The packaging material is ecological and can be recycled.
- The worn appliances contain certain noble metals. Apply to the local government about the possibilities of recycling.

- Don't throw your appliance with the household refuses
 - Get in touch with the waste collection center of your commune that is adapted to the recycling of the household appliances.

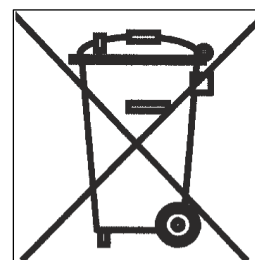

INSTALLATION INSTRUCTIONS

The installation comes under the exclusive responsibility of specialists.
The installer is held to respect the legislation and the standards enforce in his home country.

How to stick the gasket

The gasket supplied with the hob avoids all infiltration of liquids in the cabinet.
His installation has to be done carefully, in conformity of the following drawing.

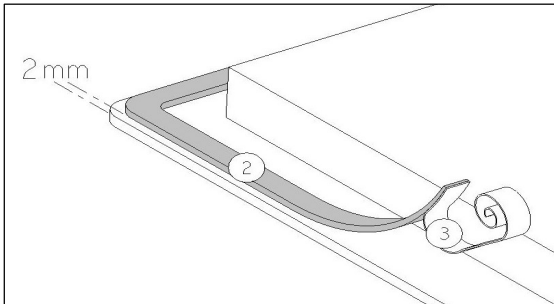

Stick the gasket (2) two millimeters from the external edge of the glass, after removing the protection sheet (3).

Fitting – installing

- The cut out sizes are:

Appliance	Cut out
7325440	370 x 490 mm

- **Ensure that there is a distance of 50 mm between the hob and the wall or sides.**
- The hobs are classified as “Y” class for heat protection. Ideally the hob should be installed with plenty of space on either side. There may be a wall at the rear and tall units or a wall at one side. **On the other side, however, no unit or divider must stand higher than the hob.**
- The piece of furniture or the support in which the hob is to be fitted, as well as the edges of furniture, the laminate coatings and the glue used to fix them, must be able to resist temperatures of up to 100 °C.
- The mural rods of edge must be heat-resisting.
- Materials which are often used to make worktops expand on contact with water. To protect the cut out edge, apply a coat of varnish or special sealant. Particular care must be given to applying the adhesive joint supplied with the hob to prevent any leakage into the supporting furniture. This gasket guaranties a correct seal when used in conjunction with smooth work top surfaces.
- Not to install the hob to the top of a not ventilated oven or a dishwasher.
- To guarantee under the bottom of the hob casing **a space of 20 mm** to ensure a good air circulation of the electronic device.
- To guarantee between the work top and the top of the drawer or oven a space of 5 mm to allow the exit of the air flow.
- If a drawer is placed under the work, avoid to put into this drawer flammable objects (for example: sprays) or not heat-resistant objects.
- The safety gap between the hob and the cooker hood placed above must respect the indications of the hood manufacturer. In case of absence of instructions respect a distance minimum of 760 mm.
- The connection cord should be subjected, after building, with no mechanical constraint, such for example of the fact of the drawer.
- The installation of the hob in no stationary sites (for example: boat) should be undertaken by specialists.

ELECTRICAL CONNECTION

- The installation of this appliance and the connection to the electrical network should be entrusted only to an electrician perfectly to the fact of the normative regulations and which respects them scrupulously.
- Protection against the parts under tension must be ensured after the building-in.
- The data of connection necessary are on the stickers place on the hob casing near the connection box.
- The connection to the main must be made using an earthed plug or via an omnipolar circuit breaking device with a contact opening of at least 3 mm.
- The electrical circuit must be separated from the network by adapted devices, for example: circuit breakers, fuses or contactors.

Caution!

This appliance has only to be connected to a network 230 V~ 50/60 Hz

Connect always the earth wire.

Respect the connection diagram.

Use the connecting cable that is attached to the device.

The green / yellow wire correspond to the earth wire, the blue wire correspond neutral wire and the brown wire correspond to the phase.

Mains	Connection	Cable diameter	Cable	Protection calibre
230V~ 50/60Hz	1 Ph. + N	3 x 2,5 mm ²	H 05 VV - F H 05 RR - F	16 A *

(*) calculated with the simultaneous factor following standard EN 60 335-2-6/1990

Caution! Ensure that you correctly attach the wires and the bridges and tighten the screws properly.

We cannot be held responsible for any incident resulting from incorrect connection or which could arise from the use of an appliance which has not been earthed or has been equipped with a faulty earth connection

Foster spa

42041 Brescello (RE) - Italy

tel. +39.0522.687425 - tel. Servizio Assistenza +39.0522.684450

fax +39.0522.686019 - fax Servizio Ricambi +39.0522.962166

e-mail: service@fosterspa.com

www.fosterspa.com