

**Operator: Save these instructions for future use!**

**FAILURE TO READ AND FOLLOW ALL INSTRUCTIONS CAREFULLY BEFORE  
 INSTALLING OR OPERATING THIS CONTROL COULD CAUSE PERSONAL  
 INJURY AND/OR PROPERTY DAMAGE.**

## PREPARATIONS

### YOUR THERMOSTAT REPLACES

Description	1F85-277
Heat Pump (No Aux. or Emergency Heat)	Yes
Heat Pump (with Aux. or Emergency Heat)	Yes
Standard Heat & Cooling Systems	Yes
Two Stage Heat & Two Stage Cool	Yes
Standard Heat Only Systems	Yes
Millivolt Heat Only Systems – Floor or Wall Furnaces	Yes
Standard Central Air Conditioning	Yes
Gas or Oil Heat	Yes
Electric Furnace	Yes
Hydronic (Hot Water) Zone Heat – 2 Wires	Yes
Hydronic (Hot Water) Zone Heat – 3 Wires	No

Assemble tools required as shown below.

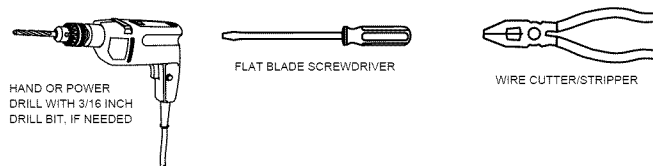

## REMOVING OLD THERMOSTAT

### CAUTION

To prevent electrical shock and/or equipment damage, disconnect electric power to system at main fuse or circuit breaker box until installation is complete.

Before removing wires from old thermostat's switching subbase, **label each wire** with the terminal designation it was removed from.

- Shut off electricity at the main fuse box until installation is complete. Ensure that electrical power is disconnected.
- Remove Old Thermostat:** A standard heat/cool thermostat consists of three basic parts:
  - The cover, which may be either a snap-on or hinge type.
  - The base, which is removed by loosening all captive screws.
  - The switching subbase, which is removed by unscrewing the mounting screws that hold it on the wall or adaptor plate.
- Remove the front cover of the old thermostat. **With wires still attached**, remove wall plate from the wall. If the old thermostat has a wall mounting plate, remove the thermostat and the wall mounting plate as an assembly.
- Identify each wire attached to the old thermostat.
- Disconnect the wires from the old thermostat one at a time. **DO NOT LET WIRES FALL BACK INTO THE WALL.**
- Install new thermostat using the following procedures.

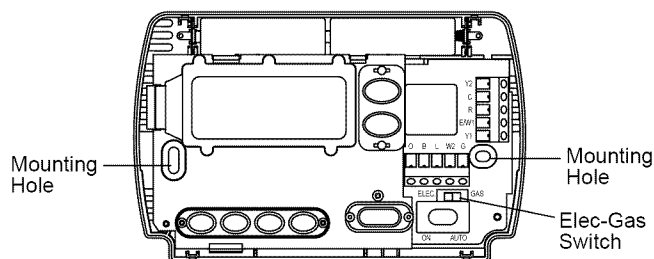

Figure 1 – Thermostat base

**ATTENTION!** This product does not contain mercury. However, this product may replace a unit which contains mercury.

Do not open mercury cells. If a cell becomes damaged, do **not** touch any spilled mercury. Wearing non-absorbent gloves, clean up the spilled mercury and place into a container which can be sealed. If a cell becomes damaged, the unit should be discarded.

Mercury must not be discarded in household trash. When the unit this product is replacing is to be discarded, place in a suitable container and return to White-Rodgers at 2895 Harrison Street, Batesville, AR 72501 for proper disposal.

# MOUNTING AND WIRING

## ⚠ WARNING

Do not use on circuits exceeding specified voltage. Higher voltage will damage control and could cause shock or fire hazard.

Do not short out terminals on gas valve or primary control to test. Short or incorrect wiring will damage thermostat and could cause personal injury and/or property damage.

Thermostat installation and all components of the system shall conform to Class II circuits per the NEC code.

## ⚠ CAUTION

Take care when securing and routing wires so they do not short to adjacent terminals or rear of thermostat. Personal injury and/or property damage may occur.

### Attach Thermostat Base to Wall

1. Remove the packing material from the thermostat. Gently pull the cover straight off the base. Forcing or prying on the thermostat will cause damage to the unit.
2. Connect wires beneath terminal screws on base using appropriate wiring schematic (see figs. 2 through 4).
3. Place base over hole in wall and mark mounting hole locations on wall using base as a template.
4. Move base out of the way. Drill mounting holes.
5. Fasten base loosely to wall, as shown in fig. 1, using two mounting screws. Place a level against bottom of base, adjust until level, and then tighten screws. (Leveling is for appearance only and will not affect thermostat operation.) If you are using existing mounting holes, or if holes drilled are too large and do not allow you to tighten base snugly, use plastic screw anchors to secure subbase.
6. Push excess wire into wall and plug hole with a fire-resistant material (such as fiberglass insulation) to prevent drafts from affecting thermostat operation.

### Electric/Gas Switch (Fan Option)

This thermostat is configured from the factory to operate a heat/cool, fossil fuel (gas, oil, etc.), forced air system. It is configured correctly for any system that DOES NOT require the thermostat to energize the fan on a call for heat. If your system is an electric heat or heat-pump system that REQUIRES the thermostat to turn on the fan on a call for heat, locate the ELEC/GAS switch on the back of the thermostat (see fig. 1) and switch it to the **ELEC** position. This will allow the thermostat to energize the fan immediately on a call for heat. If you are unsure if the heating/cooling system requires the thermostat to control the fan, contact a qualified heating and air conditioning service person.

When the thermostat is configured for Heat Pump, the thermostat will always power the circulator fan on a call for heat in the HEAT mode. The ELEC/GAS switch must be set to match the type of Auxiliary heat your system uses for proper operation in the EMERGENCY mode.

All wiring diagrams are for typical systems only. Refer to equipment manufacturers' instructions for specific system wiring information.

### Battery Location

2 "AA" alkaline batteries are included in the thermostat at the factory with a battery tag to prevent power drainage. You must remove the battery tag to engage the batteries.

If "**BATT**" is displayed, the batteries are low and should be replaced with fresh "AA" Energizer® alkaline batteries. To replace batteries, press system button to **OFF**, install the batteries along the top of the base (see Fig. 1). The batteries must be installed with the positive (+) end to the left.

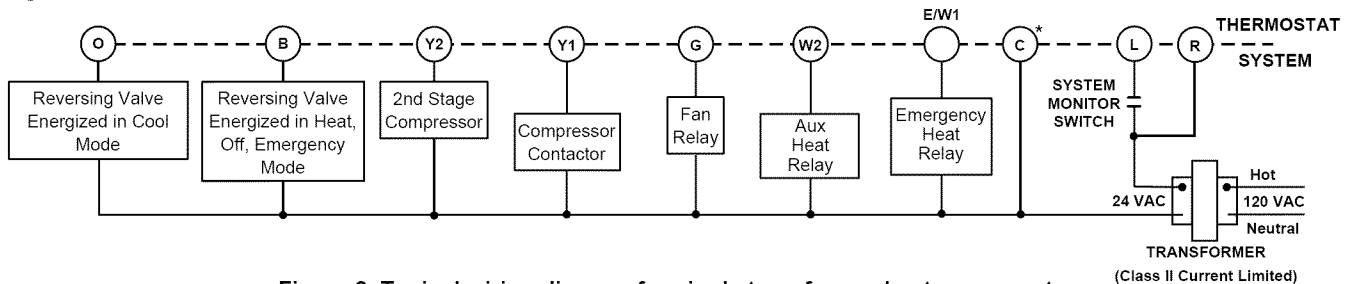

Figure 2. Typical wiring diagram for single transformer heat pump systems

\*The 24 volt neutral connection to terminal C on the thermostat is not required if you replace the batteries once a year with fresh "AA" Energizer® alkaline batteries.

## NOTE

If safety circuits are in only one of the systems, remove the transformer of the system with **NO** safety circuits.

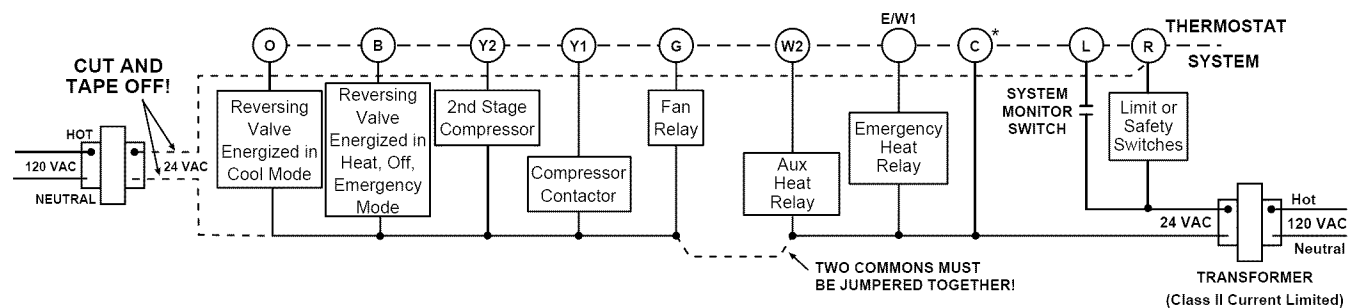

Figure 3. Typical wiring diagram for two transformer heat pump systems with **NO** safety circuits

\*The 24 volt neutral connection to terminal C on the thermostat is not required if you replace the batteries once a year with fresh "AA" Energizer® alkaline batteries.

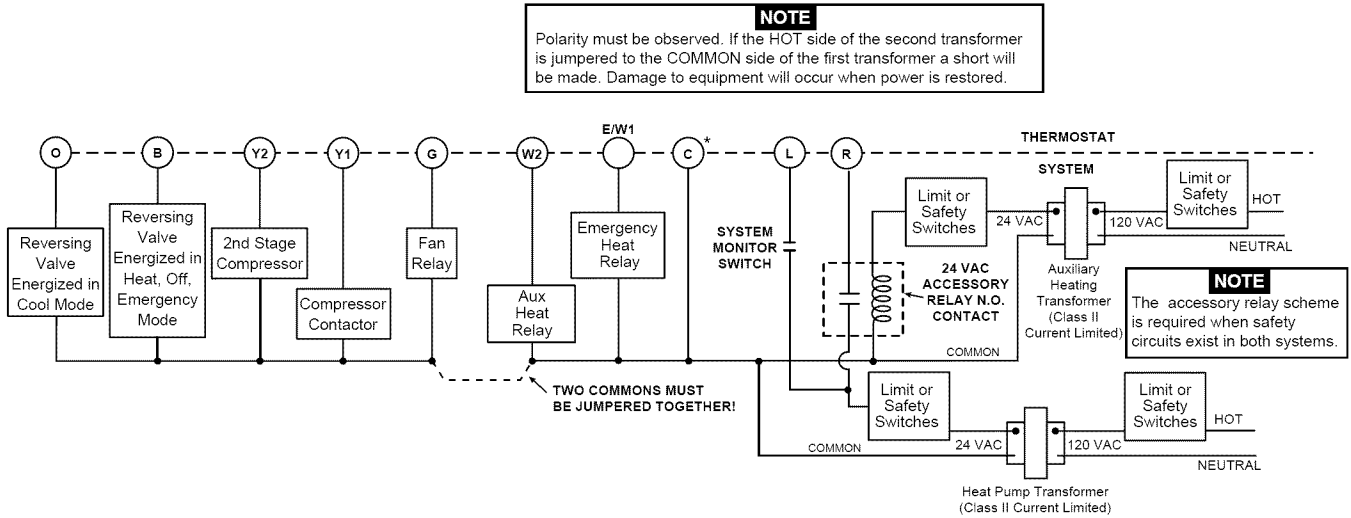

Figure 4. Typical wiring diagram for two transformer heat pump systems with safety circuits in BOTH systems

\*The 24 volt neutral connection to terminal C on the thermostat is not required if you replace the batteries once a year with fresh "AA" Energizer® alkaline batteries.

### Heat Pump Terminal Outputs

Refer to equipment manufacturers' instructions for specific system wiring information.

You can configure the thermostat for use with the following heat pump system types:

**HEAT PUMP TYPE 1.** Single stage compressor system; gas or electric backup.

This thermostat is designed to operate a single-transformer system. If you have a two-transformer system, cut and tape off

one transformer. If transformer safety circuits are in only one of the systems, remove the transformer of the system with NO safety circuits. If required, replace remaining transformer with a 75VA Class II transformer. After disconnecting one transformer, the two commons must be jumpered together.

Use the terminal output information below to help you wire the thermostat properly for your heat pump system. After wiring, see **CONFIGURATION** section for proper thermostat configuration.

THERMOSTAT TERMINALS (HEAT PUMP)										
SYSTEM	L	C*	R	W2	E/W1	Y2	Y1	G	O	B
Heat Pump 1	Malfunction Light	24 Volt (Common)	24 Volt (Hot)	HP 1 and Emergency 2nd stage	Emergency Mode 1st stage	No Output	Heat and Cool mode 1st stage (compressor)	Blower/Fan Energized on call for Heat and Cool	Energized in Cool Mode	Energized in Heat OFF
Heat Pump 2				HP 2 3rd stage		2nd stage compressor		Set GAS/ELEC switch for Emergency mode		Emergency mode

\*The 24 volt neutral connection to terminal C on the thermostat is not required if you replace the batteries once a year with fresh "AA" Energizer® alkaline batteries.

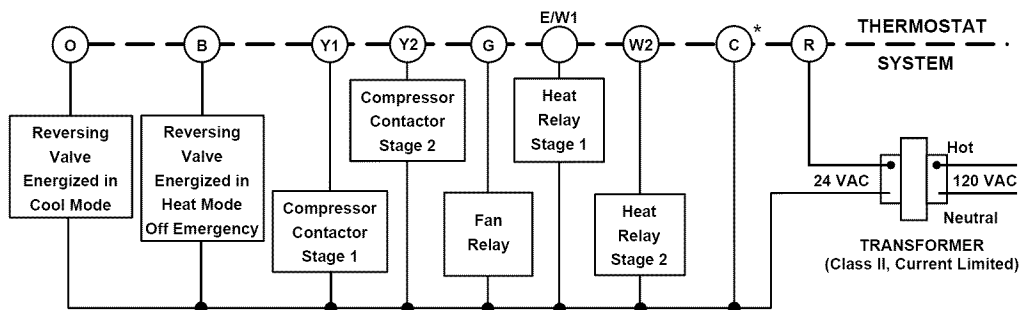

Figure 5. Typical wiring diagram for single transformer multi-stage systems

\*The 24 volt neutral connection to terminal C on the thermostat is not required if you replace the batteries once a year with fresh "AA" Energizer® alkaline batteries.

## Multi-Stage Terminal Outputs

Refer to equipment manufacturers' instructions for specific system wiring information.

You can configure the thermostat for use with either multi-stage electric heat systems or multi-stage gas systems. When configured for **electric** heat, the **G** terminal (blower/fan) will be energized on a call for heat.

This thermostat is designed to operate a single-transformer system. If you have a two-transformer system, cut and tape off

one transformer. If transformer safety circuits are in only one of the systems, remove the transformer of the system with NO safety circuits. If required, replace remaining transformer with a 75VA Class II transformer. After disconnecting one transformer, the two commons must be jumpered together.

Use the terminal output information below to help you wire the thermostat properly for your multi-stage system. After wiring, see **CONFIGURATION** section for proper thermostat configuration.

THERMOSTAT TERMINALS (MULTI-STAGE)										
SYSTEM	L	C*	R	W2	EW1	Y2	Y1	G	O	B
Multi-stage	Malfunction Light	24 Volt (Common)	24 Volt (Hot)	Heat Mode 2nd stage	Heat mode 1st stage	Cool Mode 2nd stage	Cool Mode 1st stage	Blower/Fan Energized on call for Cool (and Heat if configured to Electric Heat)	Energized in Cool Mode	Energized in Heat, Off, Emergency Modes

\*The 24 volt neutral connection to terminal C on the thermostat is not required if you replace the batteries once a year with fresh "AA" Energizer® alkaline batteries.

## CHECK THERMOSTAT OPERATION

### NOTE

To prevent static discharge problems, touch side of thermostat to release static build-up before touching any keys.

If at any time during testing your system does not operate properly, contact a qualified serviceperson.

### Fan Operation

If your system does not have a **G** terminal connection, skip to **Heating System**.

1. Turn on power to system.
2. Move FAN switch to **ON** position. The blower should begin to operate.
3. Move FAN switch to **AUTO** position. The blower should stop immediately.

### CAUTION

Do not allow the compressor to run unless the compressor oil heaters have been operational for 6 hours and the system has not been operational for at least 5 minutes.

### Heating System

1. Press SYSTEM button to select the **Flame icon** (🔥). If the auxiliary heating system has a standing pilot, be sure to light it.
2. Press ⏴ to adjust thermostat setting to 1° above room temperature. The heating system should begin to operate. The display should show **"STG1"**. However, if the setpoint temperature display is flashing, the compressor lockout feature is operating (see Configuration menu, item 5).
3. Adjust temperature setting to 3° above room temperature. If your system configuration is set at MS2, HP2 or HP1, the auxiliary heat system should begin to operate and the display should show **"STG1+2"**.
4. Press ⏴ to adjust the thermostat below room temperature. The heating system should stop operating.

### Emergency System

EMER bypasses the Heat Pump to use the heat source wired to terminal E on the thermostat. EMER is typically used when compressor operation is not desired, or you prefer back-up heat only.

1. Press SYSTEM button to select EMER. **"EMER"** will flash on the display.
2. Press ⏴ to adjust thermostat setting above room temperature. The Aux. heating system will begin to operate. The display will show **"STG1"** flashing **"EMER"** and **Flame icon** (🔥) to indicate that the Aux. system is operating.
3. Adjust temperature setting to 3° above room temperature. The auxiliary heat system should begin to operate and the display should show **"STG1+2"**.
4. Press ⏴ to adjust the thermostat below room temperature. The Aux. heating system should stop operating.

### CAUTION

To prevent compressor and/or property damage, if the outdoor temperature is below 50°F, DO NOT operate the cooling system.

### Cooling System

1. Press SYSTEM button to select the **Snowflake icon** (❄️).
2. Press ⏴ to adjust thermostat setting below room temperature. The blower should come on immediately on high speed, followed by cold air circulation. The display should show **"STG1"**.
3. Adjust temperature setting to 3° below room temperature. The second stage cooling should begin to operate and the display should show **"STG1+2"**.
4. Press ⏴ to adjust the temperature setting above room temperature. The cooling system should stop operating.

Before you begin programming your thermostat, you should be familiar with its features and with the display and the location and operation of the thermostat buttons. Your thermostat consists of two parts: the thermostat cover and the base. To remove the cover, pull it straight out from the base. To replace the cover, line up the cover with the base and press until the cover snaps onto the base.

## The Thermostat Buttons and Switches

- ① Raises temperature setting
- ② Lowers temperature setting.
- ③ TIME button.
- ④ PRGM (program) button.
- ⑤ RUN (run program) button.
- ⑥ HOLD temperature button.
- ⑦ FAN switch (ON, AUTO)
- ⑧ SYSTEM button (COOL, AUTO, HEAT, EMER, OFF)

## The Display

- ⑨ Indicates day of the week.
- ⑩ **Flame icon** (🔥) is displayed when the system is in **HEAT** mode. **Snowflake icon** (❄️) is displayed when the system is in **COOL** mode. **Flame icon** (🔥) and **Snowflake icon** (❄️) are displayed simultaneously when thermostat is in **AUTO** mode.
- ⑪ Displays **"BATT"** when the 2 "AA" batteries are low and should be replaced. Only **"BATT"** and **"LO"** in the minutes field are displayed when batteries are low and with no system power.
- ⑫ Alternately displays current time and temperature. Displays **"LO"** in the minutes field when batteries are low.
- ⑬ The word **"HOLD"** is displayed when the thermostat is in the HOLD mode. **"HOLD" is displayed flashing when the thermostat is in a temporary HOLD mode.**
- ⑭ Displays currently programmed set temperature (this is blank when SYSTEM is OFF).
- ⑮ Displays **"FLTR"** when the system has run for the programmed filter time period as a reminder to change or clean your filter.

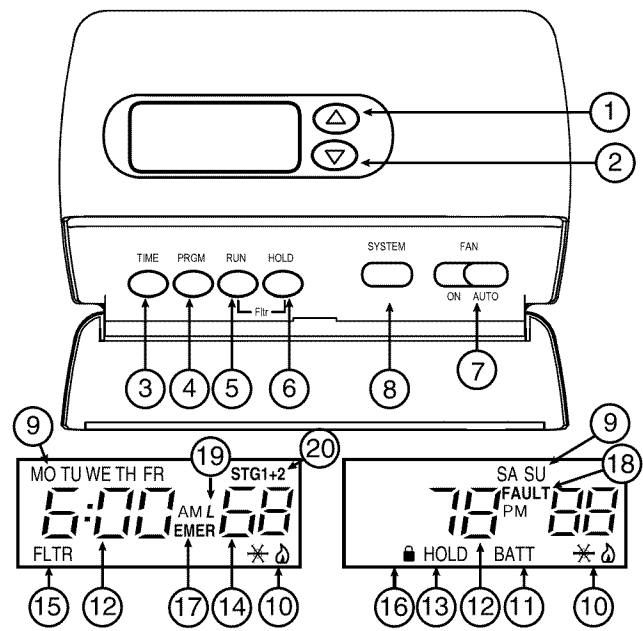

Figure 6 – Thermostat display, buttons and switches

- ⑯ Display (🔒) when in keypad lockout mode.
- ⑰ **"EMER"** is displayed flashing when the system is in EMER mode.
- ⑱ The word **"FAULT"** will be displayed when there is a malfunction in the HEAT/COOL system.
- ⑲ Display (L) when limited HEAT/COOL range is activated. The "L" icon will flash if an attempt is made to adjust the temperature beyond the limited HEAT/COOL temperature range.
- ⑳ **Stage1 & 2** indicators: The thermostat shall indicate when the first and second stage is energized except in emergency mode. The icon is **"STG 1"** for the first stage energized. The icons for the first and second stage energized are **"STG1+2"** located in the upper right side of the display.

## CONFIGURATION MENU

The configuration menu allows you to set certain thermostat operating characteristics to your system or personal requirements.





Set SYSTEM button to **OFF**, then simultaneously press  $\odot$  and  $\ominus$  to enter configuration menu. The display will show the first item in the configuration menu.

The configuration menu table summarizes the configuration options. An explanation of each option follows.



Press SYSTEM to change to the next menu item. To exit the menu and return to the program operation, press RUN. If no keys are pressed within fifteen minutes, the thermostat will revert to normal operation.

- 1) **Single Stage, Multi-stage or Heat Pump System Configuration** – This control can be configured for Heat Pump or two stage heat/two stage cool multi-stage operation. The display indicates **"MS 2"** (default for multi-stage mode) in the display. The Multi-stage configuration can be toggled to **"SS1"**, **"HP2"**, or **"HP1"** by pressing the  $\odot$  or  $\ominus$  key. In Multi-stage configuration, SYSTEM button will not have **EMER**gency mode.
- 2) **Programs Per Week** – This control can be configured for 7 independent day or 5/1/1/ programming or non-programmable mode. The display indicates **"7d"** as default. The programs per week can be toggled to **"5d"** or **"0d"** by pressing the  $\odot$  or  $\ominus$  keys. With **"0d"** selected for non-



# CONFIGURATION MENU





















Press the SYSTEM button until OFF is displayed, then press the  and  simultaneously				
INSTALLER/CONFIGURATION MENU				
Step	Press Button(s)	Displayed (Factory Default)	Press  or  to select	Comments
1	System	MS 2	SS1, HP2, HP1	Selects Single stage, Multi-stage, or Heat Pump (Single stage or 2-stage) System Configuration
2	System	7d	5d, 0d	Selects Programs Per Week
3	System	PRG 4	PRG 2	Selects Programmable Periods (PRG 2 = 2 programmable periods; PRG 4 = 4 programmable periods)
4	System	4:00 HOLD	0:15 to 4:00 (increments of 15 minutes)	Selects Temporary Program Override Time
5	System	EMR (ON)	OFF	Selects Energy Management Recovery OFF or ON
6	System	FA	SL	Selects Fast or Slow Cycle Selection
7	System	CL (OFF)	CL (ON)	Selects Compressor Lockout CL OFF or ON
8	System	CDL (ON)	CDL (OFF)	Selects Backlight Display
9	System	FA (ON)	FA (OFF)	Selects Fast Second Stage ON or OFF
10	System	0 FLTR	50-1950 (increments of 50)	Selects filter replacement run time
11	System	0°F (Room Temperature)	4 LO to 4 HI	Selects Temperature Display Adjustment 4 LO to 4 HI
12	System	°F	°C	Selects temperature display F° or °C selection
13	System	AU On	OFF	Selects AUTO Mode ON or OFF
14	System	LR (90)	LR 62 to LR89	Selects Limited HEAT range
15	System	LR (45)	LR 46 to LR 82	Selects Limited COOL range
16	System	CA (OFF)	CA (ON)	Feature Not Available
17	System	 (OFF)	(ON)	Selects Keypad Lockout
18	System	0	001 to 999	Selects Keypad lockout combination number Press System to set code
19	Run			Returns to the OFF position

programmable, SYSTEM button selection will skip Programmable periods (item 3), programmable hold time (item 4) and EMR (item 5).

- 3) Programmable Periods** – This control can be configured for 4 or 2 programmable periods. The display indicates “PRG 4” in the display as default. The programmable periods can be toggled to “PRG 2” by pressing the  or  keys.
- 4) Select Temporary Program Override Time** – The thermostat can hold any temperature you set it to for the amount of time you select on this option. Your choices are 0:15 to 4:00 hours in 15 minute increments.

Example:

- You have selected 3:00 hours for the Temporary Program Override time period.
- With the thermostat set to Heat or Cool, press  or  to set the temperature to your preference. The thermostat will maintain this temperature setting for 3 hours with “HOLD” blinking to remind you it is in Temporary Hold. After 3 hours, the thermostat will go back to the program temperature and “HOLD” will no longer blink or display.

- 5) **Select Energy Management Recovery OFF or ON** – Energy Management Recovery (EMR) causes the thermostat to start heating or cooling early to make the building temperature reach the program setpoint at the time you specify. Heating will start 5 minutes early for every 1° of temperature required to reach setpoint. Cooling allows more time per degree because it takes longer to reach temperature.
- Example:** You select EMR and have your heating programmed to 65° at night and 70° at 7 AM. If the building temperature is 65° the difference between 65° and 70° is 5°. Allowing 5 minutes per degree the thermostat setpoint will change to 70° at 6:35 AM.
- 6) **Fast or Slow Cycle Selection** – The factory default setting is fast cycle, which cycles 1st stage at approximately 1.2°F and 2nd stage 0.75°F. If you prefer slow cycle, press the  or  key to change to SL. The 1st stage and 2nd stage would be 1.5°F and 1.2°F respectively.
- 7) **Select Compressor Lockout CL OFF or ON** – Selecting CL ON will cause the thermostat to wait 5 minutes before turning on the compressor if the heating and cooling system loses power. It will also wait 5 minutes minimum between cooling and heating cycles. This is intended to help protect the compressor from short cycling. Some newer compressors already have a time delay built in and do not require this feature. Your compressor manufacturer can tell you if the lockout feature is already present in their system. When the thermostat compressor time delay occurs it will flash the setpoint for about five minutes.
- 8) **Select Backlight Display** – The display backlight improves display contrast in low lighting conditions. When the C terminal is powered, selecting backlight CdL ON will turn the light on continuously. Select backlight OFF will keep the light on momentarily after any key is pressed. When the C terminal is not powered, this selection has no effect.
- 9) **Select (Fast) Second Stage ON or OFF** – In the run mode, if the setpoint temperature is manually raised by 3°F (2°C) or more above the actual temperature with the , and the fast second stage feature is enabled, FA ON, the second stage will energize immediately. With FA OFF, second stage will not energize until the setpoint temperature is 1°F or more above actual temperature for more than ten minutes.
- 10) **Select filter replacement run time** – The thermostat will display FLTR after a set time of operation. This is a reminder to change or clean your air filter. This time can be set from 0 to 1950 hours in 50 hour increments. **A selection of 000 will cancel this feature.** When “FLTR” is displayed, you can clear it by pressing HOLD and RUN at the same time. This resets the timer and starts counting the hours until the next filter change. Contact your system manufacturer for a specific replacement/maintenance interval.
- 11) **Select Temperature Display Adjustment 4 LO to 4 HI** – Allows you to adjust the room temperature display up to 4° higher or lower. Your thermostat was accurately calibrated at the factory but you have the option to change the display temperature to match your previous thermostat. The current or adjusted room temperature will be displayed on the left side of the display.
- 12) **Select F° or C° Readout** – Changes the display readout to Centigrade or Fahrenheit as required.
- 13) **Selected Auto mode** – This control will feature AUTO changeover mode when AU on is selected (default). Press the  or  keys in the menu mode to defeat the auto changeover mode (OFF).
- 14) **Limited Heat Range** – This feature provides a maximum setpoint temperature for heat. The default setting is 90°F. It can be changed between 62°F and 89°F by pressing the  or  key.
- 15) **Limited Cool Range** – This feature provides a minimum setpoint temperature for cool. The default setting is 45°F. It can be changed between 46°F and 82°F by pressing the  or  key.
- 16) **Compressor Defeat on Comfort Alert error** – By selecting CAL on (default), the compressor will be locked when any CA error is detected. The compressor will not be locked when CA error is detected if CAL is OFF.
- 17 & 18) **Keypad Lockout** – This menu selection will display lock icon () and “OFF” (default, keypad not locked out). The  and  are used to toggle the selection between OFF and ON (keypad locked out). When the keypad lockout selection is enabled (ON), and the SYSTEM button is pressed again, the display will indicate the number “0” (default, still disabled) in the time digits. The  and  are used to set the combination number from 0 to 999. If a combination of 0 is selected and the SYSTEM button is pressed, the menu will be exited and keypad will not be locked. If 1 to 999 is selected and the SYSTEM button is pressed, the combination is stored into memory and the menu is exited. The () will display designating keypad locked with a valid combination. The SYSTEM button will operate for 10 seconds after the menu mode is exited to allow the user to change the mode from OFF to the desired SYSTEM mode.
- While the keypad is locked out, a simultaneous press of  and  will enter the configuration menu from any mode instead of only OFF mode. When the menu is entered with the keypad lockout feature enabled, the first menu item displayed is the combination code 0. The  or  keys are used to set the combination unlock number from 0 to 999. If the unlock number matches exactly with the combination lock number stored in memory when the SYSTEM button is pressed, the keypad is unlocked and the () is removed. If the unlock number does not match when the SYSTEM button is pressed, the menu is exited and the keypad remains disabled.
- To reset the combination code and unlock the keypad if the code is forgotten, see troubleshooting section.

# SPECIFICATIONS

## ELECTRICAL DATA

### Electrical Rating:

- 20 to 30 VAC 50/60 Hz or DC
- 0.05 to 1.5 Amps (Load per terminal)
- 2.5 Amps Maximum Total Load (All terminals combined)

## THERMAL DATA

### Setpoint Temperature Range:

45°F to 90°F (7°C to 32°C)

### Operating Ambient Temperature Range:

32°F to 105°F

### Operating Humidity Range:

0 to 90% RH (non-condensing)

### Shipping Temperature Range:

-40°F to 150°F

# OPERATION

The system "mode" is selected by pressing the SYSTEM button. Icons on the bottom right corner of the display will indicate the mode: **COOL** (✖), **AUTO** (✖ ⏸), **HEAT** (⏸), **EMER**, or **OFF**. In any mode except **OFF**, the setpoint temperature will be shown on the right side of the display. In **OFF**, this area will be blank. The current temperature will be displayed on the left side of the display.

To operate properly in the **AUTO** mode, the heat setpoint temperature cannot be the same as or higher than the cool setpoint temperature. The heat setpoint must be at least 1° lower than the cool setpoint.

## Automatic System Changeover

When the thermostat is in the **AUTO** mode, both the **Flame** and **Snowflake** icons are displayed. The thermostat will call for heat or cool depending on the room temperature. The setpoint temperature displayed will be that of the last mode called. If the last system cycle was heat, the **HEAT** setpoint will be displayed. If the room temperature raises above the **HEAT** setpoint and the **COOL** setpoint and a call for cool is required, the temperature displayed will change to be the **COOL** setpoint.

## Second Stage Time Delay

Your thermostat is designed to determine the optimum time to activate the second stage. Simply raising the temperature in heating or lowering it in cooling will not always force the thermostat to bring the second stage on quickly. There is a time delay from 0-30 minutes depending on the performance of the first stage of the system.

**EXAMPLE:** For the last 2 hours the thermostat is set on 70° and the room temperature is 70° with the equipment using only the first stage of heat. Since the equipment is keeping the temperature within 1° of setpoint, the thermostat will delay second stage for a longer time if you manually raise the temperature or if the room temperature quickly changes. Once the second stage comes on, it will come on sooner the next time there is a difference between the setpoint and the room temperature. The net effect of the staging program is that when the first stage is capable of making temperature the second stage will delay longer. When the thermostat calculates that first stage cannot make temperature in a reasonable time, the second stage will come on sooner. This built in function automatically optimizes the use of additional stages of heat or cool.

## Manual Operation

**Permanent Program Override (HOLD)** – With the SYSTEM button set to **HEAT** or **COOL**, press the HOLD button once and release. **"HOLD"** will be displayed. Use ⏸ or ⏸ to adjust the temperature. The thermostat will hold the room temperature at the selected setting until you press RUN button to start program operation again.

**Temperature Program Override** – Press ⏸ or ⏸ until the display shows the temperature you want. The thermostat will override current programming and keep the room temperature at the selected temperature for a programmed time period. **"HOLD"** will be displayed and flashing. The thermostat will automatically revert to the program after programmed period.

- **LOW BATTERY INDICATOR** — If the 2 "AA" alkaline batteries are low and should be replaced, the display will be blank except for **"LO BATT"**. When the batteries are low, pressing any button will cause the display to operated for ten seconds. After ten seconds, the display will be blank except for **"LO BATT"**. You cannot program with low batteries, but you can override setpoint temperature. After **"LO BATT"** has been displayed for 4 weeks, the thermostat will raise the temperature 10 degrees above your setpoint on COOL mode and will drop the temperature 10 degrees below your setpoint on HEAT mode. If the **"LO BATT"** condition continues, and when it reaches certain value, the thermostat will turn off all the loads and **"LO BATT"** will flash.

- **SIMPLIFIED COPY DAY FUNCTION** — This feature allows Monday's program to be copied into the rest of the week's programming. **This feature is available the first time you programmed your thermostat.** To use this feature, simply enter the program for Monday as described in ENTERING YOUR PROGRAM, then press RUN or HOLD. The only way to restore this feature is to complete a software reset (see Reset Operation under TROUBLESHOOTING section).

- **COPY DAY FUNCTION** — This feature allows a selected day's program to be copied to the desired day's programming. To use this feature: in PRGM mode, select the day to be copied from by pressing the HOLD button. Enter the program for the selected day as described in ENTERING YOUR PROGRAM. Press and hold the TIME button for 4 seconds to begin the COPY mode. The LCD will display **"COPY"** and the selected day to be copied. The day the program will copy to will be flashing. Press the HOLD button to select the day you want to copy to. Press TIME to complete the Copy Day operation and return to PRGM mode. Press RUN to exit.



## PROGRAMMING YOUR THERMOSTAT

This section will help you plan your thermostat's program to meet your needs. For maximum comfort and efficiency, keep the following guidelines in mind when planning your program.

- When heating (cooling) your building, program the temperatures to be cooler (warmer) when the building is vacant or during periods of low activity.
- During early morning hours, the need for cooling is usually minimal.

### Planning Your Program

Look at the factory preprogrammed times and temperatures shown in the sample schedule. If this program will suit your needs, simply press the RUN button to begin running the factory preset program.

If you want to change the preprogrammed times and temperatures, follow these steps.

Determine the time periods and temperatures for your program. You can program four or two periods for each day (see Configuration menu, item 3). You may use the same heating and cooling temperatures for consecutive time periods. You can choose start times, heating temperatures, and cooling temperatures independently (for example, you may select 5:00 AM and 70° as the weekday **1st period heating** start time and temperature and also choose 7:00 AM and 76° as the weekday **1st period cooling** start time and temperature).

Use the table to plan your program time periods and the temperatures you want during each period. Fill in the complete table to have a record of your programs.

**SAMPLE**  
Heating/Cooling Schedule Plan (Factory Program)

Period		ALL DAYS OF THE WEEK	
		Start Time	Temperature
HEAT	1ST	6:00 AM	70 F
	2ND	8:00 AM	62 F
	3RD	5:00 PM	70 F
	4TH	10:00 PM	62 F
COOL	1ST	6:00 AM	78 F
	2ND	8:00 AM	85 F
	3RD	5:00 PM	78 F
	4TH	10:00 PM	82 F

## Entering Your Program

### Set Current Time and Day

1. Press TIME button once. The display will show the hour only.

EXAMPLE:

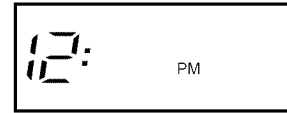

2. Press and hold either  $\ominus$  or  $\oplus$  until you reach the correct hour and AM/PM designation (**AM** begins at midnight; **PM** begins at noon).
3. Press TIME once again. The display window will show the minutes only.

EXAMPLE:

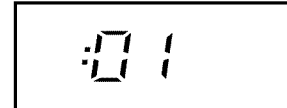

4. Press and hold either  $\ominus$  or  $\oplus$  until you reach the correct minutes.
5. Press TIME once again. The display will show the day of the week.
6. Press  $\ominus$  or  $\oplus$  until you reach the current day of the week.
7. Press RUN once. The display will show the correct time and room temperature alternately.

### Enter Heating Program

1. Move the SYSTEM switch to **HEAT**.
2. Press PRGM once. "MO" (indicating Monday program) will appear in the display. Also displayed are the currently programmed start time for the **1st heating** period and the currently programmed temperature (flashing).

EXAMPLE:

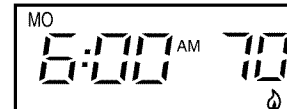

This display window shows that for Monday's 1st heating period, the start time is 6:00 AM, and 70° is the programmed temperature (this example reflects factory preprogramming).

3. Press  $\ominus$  or  $\oplus$  to change the displayed temperature to your selected temperature for Monday's 1st heating program period.
4. Press TIME once (the programmed time will flash). Press  $\ominus$  or  $\oplus$  until your selected start time for Monday's 1st

Heating/Cooling Schedule Plan

	PERIOD 1				PERIOD 2				PERIOD 3				PERIOD 4			
	HEAT		COOL		HEAT		COOL		HEAT		COOL		HEAT		COOL	
	Time	Temp	Time	Temp	Time	Temp	Time	Temp	Time	Temp	Time	Temp	Time	Temp	Time	Temp
Mon																
Tues																
Wed																
Thur																
Fri																
Sat																
Sun																

## OPERATION

heating program period appears. The time will change in 15-minute increments. When your selected time is displayed, press TIME again to return to the change temperature mode.

5. Press PRGM once. The currently programmed start time and setpoint temperature for the **Monday's 2nd heating** program period will appear.
6. Repeat steps 3 and 4 to select the start time and heating temperature for Monday's 2nd heating program period.
7. Repeat steps 3 through 5 for the 3rd and 4th heating program periods. Monday heating programs are now complete.

### NOTE

If you are programming your thermostat for the first time and you want programming for all days of the week to be the same as Monday's program, press RUN or HOLD at this point, and proceed to **Enter Cooling Program**. (This simplified COPY DAY feature only works the first time you program your thermostat. If you want to copy one day's programming to a specific day programming, refer to COPY DAY FUNCTION in OPERATING FEATURES. If you are changing your thermostat's programming, you must program each day separately.)

8. Press PRGM once. "TU" (indicating Tuesday program) will appear in the display, along with the start time for the 1st heating period and the currently programmed temperature.
9. Repeat steps 3 through 7 to complete Tuesday's heating programming.
10. Continue entering each day's programming until all heating periods time and temperatures have been entered.
11. When you have complete entering your heating program, press RUN.

## Enter Cooling Program

### ⚠ CAUTION

If the outside temperature is below 50°F, disconnect power to the cooling system before programming. Energizing the air conditioner compressor during cold weather may cause personal injury or property damage.

1. Press SYSTEM button to **COOL** position.
2. Follow **Enter Heating Program** for entering your cooling program, using your selected cooling times and temperatures.

### CHECK YOUR PROGRAMMING

Follow these steps to check your thermostat programming one final time before beginning thermostat operation.

1. Press SYSTEM button to **HEAT** position.
2. Press PRGM to view the 1st Monday heating period time and temperature. Each time you press PRGM, the next heating period time and temperature will be displayed in sequence for each weekday, then Saturday and Sunday program periods (you may change any time or temperature during this procedure).
3. Press RUN.
4. Press SYSTEM button to **COOL** position.
5. Repeat step 2 to check cooling program.
6. Press SYSTEM button to **HEAT** or **COOL** and press RUN to begin program operation.

NOTE: Batteries are not required to keep your programming or menu data. With two optional "AA" batteries installed, your thermostat will maintain time and continuously display the temperature during a loss of AC power. Installed batteries will also allow programming prior to installation.

**YOUR THERMOSTAT IS NOW PROGRAMMED AND READY TO PROVIDE MAXIMUM COMFORT AND EFFICIENCY!**



## TROUBLESHOOTING

### Reset Operation

If a voltage spike or static discharge blanks out the display or causes erratic thermostat operation, you can reset the thermostat by removing the wires from terminals **R** and **C** and removing batteries for 2 minutes. After resetting the thermostat, replace the wires and batteries. If the thermostat has been reset and still does not function correctly, contact your heating/cooling service person or place of purchase.

Symptom	Possible Cause	Corrective Action
<b>No Heat/No Cool/No Fan (common problems)</b>	<ol style="list-style-type: none"> <li>1. Blown fuse or tripped circuit breaker.</li> <li>2. Furnace power switch to OFF.</li> <li>3. Furnace blower compartment door or panel loose or not properly installed.</li> </ol>	<p>Replace fuse or reset breaker. Turn switch to ON. Replace door panel in proper position to engage safety interlock or door switch.</p>
<b>No Heat</b>	<ol style="list-style-type: none"> <li>1. Pilot light not lit.</li> <li>2. SYSTEM button not set to <b>HEAT</b>.</li> <li>3. Loose connection to thermostat or system.</li> <li>4. Furnace Lock-Out Condition. Heat may also be intermittent.</li> <li>5. Heating system requires service or thermostat requires replacement.</li> </ol>	<p>Re-light pilot. Press SYSTEM button to <b>HEAT</b> and raise setpoint above room temperature. Verify thermostat and system wires are securely attached. Many furnaces have safety devices that shut down when a lock-out condition occurs. If the heat works intermittently contact the furnace manufacturer or local service person for assistance. Diagnostic: Press SYSTEM button to <b>HEAT</b> and raise the setpoint above room temperature. Within a few seconds the thermostat should make a soft click</p>

## TROUBLESHOOTING

Symptom	Possible Cause	Corrective Action
<b>No Heat (continued)</b>	5. Heating system requires service or thermostat requires replacement. (continued)	sound. This sound usually indicates the thermostat is operating properly. If the thermostat does not click, try the reset operation listed above. If the thermostat does not click after being reset contact your heating and cooling service person or place of purchase for a replacement. If the thermostat clicks, contact the furnace manufacturer or a service person to verify the heating is operating correctly.
<b>No Cool</b>	<ol style="list-style-type: none"> <li>1. SYSTEM button not pressed to <b>COOL</b>.</li> <li>2. Loose connection to thermostat or system.</li> <li>3. Cooling system requires service or thermostat requires replacement.</li> </ol>	<p>Press SYSTEM button to <b>COOL</b> and lower setpoint below room temperature.</p> <p>Verify thermostat and system wires are securely attached.</p> <p>Same procedure as diagnostic for No Heat condition except set the thermostat to <b>COOL</b> and lower the setpoint below the room temperature. There may be up to a five minute delay before the thermostat clicks in Cooling.</p>
<b>Heat, Cool or Fan Runs Constantly</b>	<ol style="list-style-type: none"> <li>1. Possible short in wiring.</li> <li>2. Possible short in thermostat.</li> <li>3. Possible short in heat/cool/fan system.</li> <li>4. FAN Switch set to Fan On.</li> </ol>	Check each wire connection to verify they are not shorted or touching together. No bare wire should stick out from under terminal screws. Try resetting the thermostat as described above. If the condition persists the manufacturer of your system or service person can instruct you on how to test the Heat/Cool system for correct operation. If the system operates correctly, replace the thermostat.
<b>Furnace (Air Conditioner) Cycles Too Fast or Too Slow (narrow or wide temperature swing)</b>	1. The location of the thermostat and/or the size of the Heating System may be influencing the cycle rate.	Digital thermostats normally provide precise temperature control and may cycle faster than some older mechanical models. A faster cycle rate means the unit turns on and off more frequently but runs for a shorter time so there is no increase in energy use. If you would like to increase the cycle time, choose <b>SL</b> for slow cycle in the menu, step 4. If an acceptable cycle rate is not achieved as received or by choosing slow cycle, contact a local service person for additional suggestions.
<b>Thermostat Setting &amp; Thermostat Thermometer Disagree</b>	1. Thermostat thermometer setting requires adjustment.	The thermometer can be adjusted +/- 4 degrees. See Temperature Display Adjustment in the Configuration Menu section.
<b>Blank Display and/or Keypad Not Responding</b>	1. Voltage spike or static discharge.	Use the Reset Operation at top of previous page.
<b>Heat Setpoint will not Respond to the Temperature Up Key</b>	1. The desired setpoint conflicts with the setpoint of the <b>COOL</b> mode.	Change system mode to <b>COOL</b> . Raise the Cool setpoint. Return to <b>HEAT</b> mode and set desired temperature.
<b>Cool Setpoint will not Respond to the Temperature Down Key</b>	1. The desired setpoint conflicts with the setpoint of the <b>HEAT</b> mode.	Change system mode to <b>HEAT</b> . Lower the Heat setpoint. Return to <b>COOL</b> mode and set desired temperature.
<b>Forgot Keypad Lockout Code</b>		<p>CAUTION: This resets the thermostat to factory default settings of the configuration menu. After performing this reset, the thermostat will require configuration again. Be sure that you know the required configuration settings before resetting.</p> <p>With the thermostat in any mode, press  and  at the same time to enter the configuration menu at the point where the lockout code is to be entered. Press</p>

# TROUBLESHOOTING

Symptom	Possible Cause	Corrective Action
Forgot Keypad Lockout Code (continued)		⏪ and ⏩ and SYSTEM button at the same time to reset the lockout code, unlock the keypad and reset all configuration menu settings.
Why won't my 2nd or 3rd stage come on?	First stage is keeping up with demand.	Your thermostat is designed to determine the optimum time to activate the second stage. Simply raising the temperature in heating or lowering it in cooling will not always force the thermostat to bring the second stage on quickly. There is a time delay from 0-30 minutes depending on the performance of the first stage of the system.

# FAQ

Symptom	Corrective Action
My thermostat is reading in Celsius. How do I change it to Fahrenheit?	Your thermostat display can be set to display temperature in Fahrenheit or Celsius. This option can be set in the INSTALLER/CONFIGURATION MENU of your thermostat. See page 6 step 12.
Do I have to program a stop time for each program period?	There is no need to select a time to stop a programming period. Starting a new programming period will stop the previous program period.
My thermostat does not follow it's program. What should I do?	Unless the thermostat appears to be damaged it will follow the program that is in the memory. The most common reason a thermostat will appear not to be following the program is a programming error. Verify that the AM or PM settings are correct for each period. Also verify that the Day of the week is set correctly. Models with EMR (Energy Management Recovery) start early to make the temperature they are programmed for by the time specified in the program. See the CONFIGURATION MENU on page 6 step 3.
Between heating and cooling seasons, I want to turn my system off. Will this change my program?	Any time you wish to turn your system off, simply press the SYSTEM button until "OFF" is displayed. This will not affect your thermostat's programming in any way. To turn the system back on, press the SYSTEM button to <b>HEAT</b> or <b>COOL</b> and press RUN. The system will begin operating according to the current thermostat program. See under OPERATION page 8 & 9.
My display light does not work. Can it be fixed or replaced?	Because it is soldered to the circuit board it is not possible to repair or replace.
Do I have to reprogram my thermostat after I change the batteries?	No. This thermostat has permanent memory, although you will have to reset your clock.
My setpoint temperature is flashing. What does that mean?	When the thermostat compressor time delay occurs it will flash the setpoint for about five minutes. This is intended to help protect the compressor from short cycling.
How can I get a copy of the Operating Manual for my thermostat?	Visit our website at <a href="http://www.white-roddgers.com">www.white-roddgers.com</a> for operating manuals.
My program or configuration menu is all messed up, how do I start from the beginning?	You can perform software reset by pressing ⏪ ⏩ and SYSTEM buttons simultaneously when SYSTEM mode is <b>OFF</b> . See "Forget Keypad Lockout Code" under "TROUBLESHOOTING" for details.



The Emerson logo is a trademark and service mark of Emerson Electric Co.

St. Louis, Missouri      Markham, Ontario  
 314-577-1300              905-201-4701  
[www.white-roddgers.com](http://www.white-roddgers.com)