

M3A76-CM



Motherboard

E4414

First Edition V1

January 2009

Copyright © 2009 ASUSTeK Computer Inc. All Rights Reserved.

No part of this manual, including the products and software described in it, may be reproduced, transmitted, transcribed, stored in a retrieval system, or translated into any language in any form or by any means, except documentation kept by the purchaser for backup purposes, without the express written permission of ASUSTeK Computer Inc. ("ASUS").

Product warranty or service will not be extended if: (1) the product is repaired, modified or altered, unless such repair, modification or alteration is authorized in writing by ASUS; or (2) the serial number of the product is defaced or missing.

ASUS PROVIDES THIS MANUAL "AS IS" WITHOUT WARRANTY OF ANY KIND, EITHER EXPRESS OR IMPLIED, INCLUDING BUT NOT LIMITED TO THE IMPLIED WARRANTIES OR CONDITIONS OF MERCHANTABILITY OR FITNESS FOR A PARTICULAR PURPOSE. IN NO EVENT SHALL ASUS, ITS DIRECTORS, OFFICERS, EMPLOYEES OR AGENTS BE LIABLE FOR ANY INDIRECT, SPECIAL, INCIDENTAL, OR CONSEQUENTIAL DAMAGES (INCLUDING DAMAGES FOR LOSS OF PROFITS, LOSS OF BUSINESS, LOSS OF USE OR DATA, INTERRUPTION OF BUSINESS AND THE LIKE), EVEN IF ASUS HAS BEEN ADVISED OF THE POSSIBILITY OF SUCH DAMAGES ARISING FROM ANY DEFECT OR ERROR IN THIS MANUAL OR PRODUCT.

SPECIFICATIONS AND INFORMATION CONTAINED IN THIS MANUAL ARE FURNISHED FOR INFORMATIONAL USE ONLY, AND ARE SUBJECT TO CHANGE AT ANY TIME WITHOUT NOTICE, AND SHOULD NOT BE CONSTRUED AS A COMMITMENT BY ASUS. ASUS ASSUMES NO RESPONSIBILITY OR LIABILITY FOR ANY ERRORS OR INACCURACIES THAT MAY APPEAR IN THIS MANUAL, INCLUDING THE PRODUCTS AND SOFTWARE DESCRIBED IN IT.

Products and corporate names appearing in this manual may or may not be registered trademarks or copyrights of their respective companies, and are used only for identification or explanation and to the owners' benefit, without intent to infringe.

Contents

Notices.....	vi
Safety information	vii
About this guide	vii
M3A76-CM specifications summary	ix

Chapter 1: Product introduction

1.1	Welcome!	1-1
1.2	Package contents	1-1
1.3	Special features	1-1
1.3.1	Product highlights	1-1
1.3.2	Innovative ASUS features	1-3
1.4	Before you proceed	1-5
	Onboard LED	1-5
1.5	Motherboard overview	1-6
1.5.1	Placement direction	1-6
1.5.2	Screw holes	1-6
1.5.3	Motherboard layout.....	1-7
1.5.4	Layout contents.....	1-7
1.6	Central Processing Unit (CPU)	1-8
1.6.1	Installing the CPU	1-8
1.6.2	Installing the heatsink and fan	1-10
1.7	System memory	1-11
1.7.1	Overview	1-11
1.7.2	Memory configurations.....	1-12
1.7.3	Installing a DIMM	1-15
1.6.4	Removing a DIMM	1-15
1.8	Expansion slots	1-16
1.8.1	Installing an expansion card	1-16
1.8.2	Configuring an expansion card	1-16
1.8.4	PCI slots.....	1-16
1.8.5	PCI Express x1 slot.....	1-16
1.8.6	PCI Express x16 slot.....	1-16
1.9	Jumpers	1-17
1.10	Connectors	1-18
1.10.1	Rear panel connectors.....	1-18
1.10.2	Internal connectors	1-20

Contents

1.11	Software support	1-27
1.11.1	Installing an operating system	1-27
1.11.2	Support DVD information	1-27

Chapter 2: BIOS information

2.1	Managing and updating your BIOS	2-1
2.1.1	ASUS Update utility	2-1
2.1.2	ASUS EZ Flash 2 utility.....	2-2
2.1.3	ASUS CrashFree BIOS 3 utility	2-3
2.2	BIOS setup program	2-4
2.2.1	BIOS menu screen.....	2-5
2.2.2	Menu bar.....	2-5
2.2.3	Navigation keys.....	2-6
2.2.4	Menu items	2-6
2.2.5	Submenu items	2-6
2.2.6	Configuration fields	2-6
2.2.7	General help	2-6
2.2.8	Pop-up window	2-6
2.2.9	Scroll bar.....	2-6
2.3	Main menu	2-7
2.3.1	System Time	2-7
2.3.2	System Date	2-7
2.3.3	Primary IDE Master/Slave and SATA 1~6.....	2-7
2.3.4	SATA Configuration	2-8
2.3.5	System Information	2-9
2.4	Advanced menu	2-9
2.4.1	JumperFree Configuration	2-9
2.4.2	CPU Configuration	2-12
2.4.3	Chipset.....	2-12
2.4.4	Onboard Devices Configuration.....	2-13
2.4.5	PCI PnP	2-14
2.4.6	USB Configuration	2-14
2.5	Power menu	2-15
2.5.1	Suspend Mode.....	2-15
2.5.2	ACPI 2.0 Support	2-15
2.5.3	ACPI APIC Support.....	2-15

Contents

2.5.4	APM Configuration	2-15
2.5.5	HW Monitor Configuration.....	2-16
2.6	Boot menu	2-17
2.6.1	Boot Device Priority	2-17
2.6.2	Boot Settings Configuration	2-17
2.6.3	Security	2-18
2.7	Tools menu	2-19
2.7.1	ASUS EZ Flash 2.....	2-19
2.7.2	Express Gate	2-20
2.8	Exit menu	2-21

Notices

Federal Communications Commission Statement

This device complies with Part 15 of the FCC Rules. Operation is subject to the following two conditions:

- This device may not cause harmful interference, and
- This device must accept any interference received including interference that may cause undesired operation.

This equipment has been tested and found to comply with the limits for a Class B digital device, pursuant to Part 15 of the FCC Rules. These limits are designed to provide reasonable protection against harmful interference in a residential installation. This equipment generates, uses and can radiate radio frequency energy and, if not installed and used in accordance with manufacturer's instructions, may cause harmful interference to radio communications. However, there is no guarantee that interference will not occur in a particular installation. If this equipment does cause harmful interference to radio or television reception, which can be determined by turning the equipment off and on, the user is encouraged to try to correct the interference by one or more of the following measures:

- Reorient or relocate the receiving antenna.
- Increase the separation between the equipment and receiver.
- Connect the equipment to an outlet on a circuit different from that to which the receiver is connected.
- Consult the dealer or an experienced radio/TV technician for help.



The use of shielded cables for connection of the monitor to the graphics card is required to assure compliance with FCC regulations. Changes or modifications to this unit not expressly approved by the party responsible for compliance could void the user's authority to operate this equipment.

Canadian Department of Communications Statement

This digital apparatus does not exceed the Class B limits for radio noise emissions from digital apparatus set out in the Radio Interference Regulations of the Canadian Department of Communications.

This class B digital apparatus complies with Canadian ICES-003.



DO NOT throw the motherboard in municipal waste. This product has been designed to enable proper reuse of parts and recycling. This symbol of the crossed out wheeled bin indicates that the product (electrical and electronic equipment) should not be placed in municipal waste. Check local regulations for disposal of electronic products.



DO NOT throw the mercury-containing button cell battery in municipal waste. This symbol of the crossed out wheeled bin indicates that the battery should not be placed in municipal waste.

Safety information

Electrical safety

- To prevent electrical shock hazard, disconnect the power cable from the electrical outlet before relocating the system.
- When adding or removing devices to or from the system, ensure that the power cables for the devices are unplugged before the signal cables are connected. If possible, disconnect all power cables from the existing system before you add a device.
- Before connecting or removing signal cables from the motherboard, ensure that all power cables are unplugged.
- Seek professional assistance before using an adapter or extension cord. These devices could interrupt the grounding circuit.
- Ensure that your power supply is set to the correct voltage in your area. If you are not sure about the voltage of the electrical outlet you are using, contact your local power company.
- If the power supply is broken, do not try to fix it by yourself. Contact a qualified service technician or your retailer.

Operation safety

- Before installing the motherboard and adding devices on it, carefully read all the manuals that came with the package.
- Before using the product, ensure that all cables are correctly connected and the power cables are not damaged. If you detect any damage, contact your dealer immediately.
- To avoid short circuits, keep paper clips, screws, and staples away from connectors, slots, sockets and circuitry.
- Avoid dust, humidity, and temperature extremes. Do not place the product in any area where it may become wet.
- Place the product on a stable surface.
- If you encounter technical problems with the product, contact a qualified service technician or your retailer.

About this guide

This user guide contains the information you need when installing and configuring the motherboard.

How this guide is organized

This guide contains the following parts:

- **Chapter 1: Product introduction**
This chapter describes the features of the motherboard and the new technology it supports.
- **Chapter 2: BIOS information**
This chapter tells how to change system settings through the BIOS Setup menus. Detailed descriptions of the BIOS parameters are also provided.

Conventions used in this guide

To ensure that you perform certain tasks properly, take note of the following symbols used throughout this manual.



DANGER/WARNING: Information to prevent injury to yourself when trying to complete a task.



CAUTION: Information to prevent damage to the components when trying to complete a task.



IMPORTANT: Instructions that you **MUST** follow to complete a task.



NOTE: Tips and additional information to help you complete a task.

Where to find more information

Refer to the following sources for additional information and for product and software updates.

1. ASUS websites

The ASUS website provides updated information on ASUS hardware and software products. Refer to the ASUS contact information.

2. Optional documentation

Your product package may include optional documentation, such as warranty flyers, that may have been added by your dealer. These documents are not part of the standard package.

Typography

Bold text

Indicates a menu or an item to select.

Italics

Used to emphasize a word or a phrase.

<Key>

Keys enclosed in the less-than and greater-than sign means that you must press the enclosed key.

Example: <Enter> means that you must press the Enter or Return key.

<Key1>+<Key2>+<Key3>

If you must press two or more keys simultaneously, the key names are linked with a plus sign (+).

Example: <Ctrl>+<Alt>+<D>

Command

Means that you must type the command exactly as shown, then supply the required item or value enclosed in brackets.

Example: At the DOS prompt, type the command line:

```
afudos /i [filename]
```

```
afudos /iM3A76CM.ROM
```

M3A76-CM specifications summary

CPU	<p>AMD® Socket AM2+ / AM2 for AMD Phenom™ FX / Phenom™ / Athlon™ / Sempron™ processor</p> <p>AMD64 architecture enables simultaneous 32-bit and 64-bit computing</p> <p>Supports up to 125W CPU</p> <p>AMD Cool 'n' Quiet™ Technology</p>
Chipset	AMD 760G / SB710
System bus	Up to 5200 MT/s HyperTransport™ 3.0 interface for AM2+ CPU 2000 / 1600 MT/s for AM2 CPU
Memory	<p>Dual-channel memory architecture</p> <p>4 x 240-pin DIMM slots support unbuffered ECC and non-ECC DDR2 1066/800/667/533MHz</p> <p>Supports up to 8GB system memory</p> <p>* Due to AM2+ CPU limitation, only one DDR2 1066 DIMM is supported per channel. When four DDR2 1066 DIMMs are installed, all DIMMs run at 800MHz frequency by default for system stability.</p> <p>** Refer to www.asus.com or user manual for Memory QVL (Qualified Vendors List)</p> <p>*** Due to the memory address limitation on 32-bit Windows OS, when you install 4GB or more memory on the motherboard, the actual usable memory for the OS can be about 3GB or less. For effective use of memory, we recommend that you install a 64-bit Windows OS when having 4GB or more memory installed on the motherboard.</p>
Expansion slots	<p>1 x PCI Express™ x16 slot</p> <p>1 x PCI Express™ x1 slots</p> <p>2 x PCI slots</p> <p>Support PCI Express™ 2.0 / 1.0 Architecture</p>
Storage	<p>1 x UltraDMA 133/100/66/33</p> <p>6 x Serial ATA 3Gb/s connectors</p> <p>Supports RAID 0, RAID 1, RAID 0+1, RAID 5, and JBOD configuration (in Windows Vista only)</p>
Audio	<p>High Definition Audio 8-channel CODEC</p> <p>Supports Jack-Detect, Multistreaming Technologies, and S/PDIF Out interface</p>
USB	Supports up to 12 USB 2.0/1.1 ports (6 ports at mid-board, 6 ports at the back panel)
LAN	RTL8111C Gigabit LAN
Back panel I/O ports	<p>1 x PS/2 Keyboard/Mouse port</p> <p>1 x DVI port</p> <p>1 x VGA port</p> <p>1 x RJ45 port</p> <p>6 x USB 2.0/1.1 ports</p> <p>8-channel Audio I/O ports</p>

(continued on the next page)

M3A76-CM specifications summary

Internal I/O connectors	<p>3 x USB 2.0 connectors support additional 6 USB 2.0/1.1 ports</p> <p>1 x IDE connector</p> <p>1 x COM connector</p> <p>6 x SATA connectors</p> <p>1 x High definition front panel audio connector</p> <p>1 x system panel connector</p> <p>1 x CD audio-in connector</p> <p>1 x S/PDIF output connector</p> <p>1 x Printer port</p> <p>1 x chassis intrusion connector</p> <p>1 x CPU / 1 x Chassis fan connectors</p> <p>24-pin EATX power connector</p> <p>4-pin ATX 12V power connector</p>
Graphics	<p>Integrated ATI Radeon 3000</p> <p>Supports maximum shared memory up to 256MB</p> <p>Supports DVI-D with HDCP compliant with max. resolution up to 1920 x 1200 @60Hz dual-link</p> <p>Supports RGB with max. resolution up to 2048 x 1536 @85Hz</p> <p>Supports single-link DVI interface</p>
ASUS special features	<p>ASUS Q-Fan</p> <p>ASUS CrashFree BIOS3</p> <p>ASUS EZ Flash2</p> <p>ASUS MyLogo2</p> <p>ASUS AI NET2</p> <p>ASUS Express Gate</p>
ASUS Overclocking features	<p>SFS (Stepless Frequency Selection) from 200MHz to 550MHz at 1MHz increment</p> <p>Adjustable DRAM voltage</p> <p>ASUS CPR (CPU Parameter Recall)</p>
BIOS	<p>8Mb Flash ROM, AMI BIOS, PnP, DMI2.0, WfM2.0, ACPI2.0, SMBIOS 2.5</p>
Accessories	<p>User manual</p> <p>1 x Serial ATA cable</p> <p>1 x UltraDMA 133/100/66/33 cable</p> <p>1 x I/O shield</p>
Form Factor	<p>uATX Form factor: 9.6" x 9.6" (24.4cm x 24.4cm)</p>
Support DVD	<p>Drivers</p> <p>ASUS PC Probe II</p> <p>ASUS LiveUpdate Utility</p> <p>Anti-Virus software (OEM version)</p>

*Specifications are subject to change without notice.

Chapter 1

Product introduction

1.1 Welcome!

Thank you for buying an ASUS® M3A76-CM motherboard!

The motherboard delivers a host of new features and latest technologies, making it another standout in the long line of ASUS quality motherboards!

Before you start installing the motherboard, and hardware devices on it, check the items in your package with the list below.

1.2 Package contents

Check your motherboard package for the following items.

Motherboard	ASUS M3A76-CM motherboard
Cables	1 x Serial ATA cable 1 x Ultra DMA 133/100/66/33 cable
Accessories	1 x I/O shield
Application DVD	ASUS motherboard support DVD
Documentations	User manual



If any of the above items is damaged or missing, contact your retailer.

1.3 Special features

1.3.1 Product highlights



AMD® Socket AM2+ Phenom™ FX / Phenom™ / Athlon™ CPU support

This motherboard supports AMD® Socket AM2+ multi-core processors with unique L3 cache and delivers better overclocking capabilities with less power consumption. It features dual-channel DDR2 1066 memory support and accelerates data transfer rate up to 5200MT/s via HyperTransport™ 3.0 based system bus.



AMD® Socket AM2 Athlon™ / Sempron™ CPU support

The motherboard supports AMD® Socket AM2 Athlon™ processors. It features 2000 / 1600 MT/s HyperTransport™-based system bus, dual-channel un-buffered DDR2 800 memory support and AMD™ Cool 'n' Quiet™ Technology.



HyperTransport™ 3.0 support

HyperTransport™ 3.0 technology provides 2.6 times more bandwidth than HT1.0 that radically improves system efficiency for a smoother, faster computing environment.



64-bit CPU support

64-bit computing, the next generation technology to replace the current 32-bit architecture, delivers advanced system performance, faster memory access, and increased productivity. This motherboard provides excellent compatibility and flexibility by supporting either 64-bit or 32-bit architecture.



Dual-core CPU

Enjoy the extraordinary CPU power from the latest dual-core CPU. The advanced processing technology contains two physical CPU cores with individually dedicated L2 cache to satisfy the rising demand for more powerful processing capability.



Gigabit LAN solution

The onboard LAN controller is a highly integrated Gb LAN controller. It is enhanced with an ACPI management function to provide efficient power management for advanced operating systems.



AMD Cool 'n' Quiet Technology

The motherboard supports the AMD Cool 'n' Quiet Technology, which monitors system operation and automatically adjusts CPU voltage and frequency for a cool and quiet operating environment.



Dual channel DDR2 1066 support

This motherboard supports DDR2 1066, which provides faster data transfer rate and more bandwidth to increase memory data transfer rate and computing efficiency. This enhances system performance in 3D graphics and other memory demanding applications.



- DDR2 1066 is supported by AM2+ CPU only. Refer to the ASUS website at www.asus.com for the supported CPU models.
- Due to AM2+ CPU limitation, only one DDR2 1066 DIMM is supported per channel. When four DDR2 1066 DIMMs are installed, all DIMMs run at 800MHz frequency by default for system stability.



PCI Express 2.0 support

This motherboard supports the latest PCIe 2.0 devices for double speed and bandwidth which enhances system performance.



AMD 760G

The AMD 760G Northbridge is the latest AMD chipset designed for 5200MT/s HyperTransport™ 3.0 (HT 3.0) interface speed and external graphics in PCI Express™ 2.0 standard. It features the integrated ATI HD3000 graphics and fully DirectX 10.0 compliant.



DVI Interface

DVI (Digital Visual Interface) provides high visual quality of digital display devices such as LCD monitors.



Serial ATA 3Gb/s technology

The motherboard supports next-generation SATA hard drives based on the new SATA 3Gb/s storage specification.



8-channel High Definition Audio

The onboard 8-channel VT1708B High Definition Audio CODEC enables high-quality audio that automatically detects peripherals plugged into the audio I/O jacks. VT1708B also supports the Windows® Vista Premium OS.



USB 2.0 technology

USB 2.0 is the latest connectivity standard for next generation components and peripherals. Backwards compatible with current USB 1.1 peripherals, USB 2.0 delivers transfer speeds up to 40 times faster at 480Mb/s, for easy connectivity and ultra-fast data transfers.

1.3.2 Innovative ASUS features



ASUS MyLogo2™

Turn your favorite photos into 256-color boot logos to personalize your system.



ASUS CrashFree BIOS 3

ASUS CrashFree BIOS 3 is an auto-recovery tool that allows you to restore a corrupted BIOS file using the bundled support DVD or USB disk that contains the BIOS file.



ASUS EZ Flash 2

ASUS EZ Flash 2 is a utility that allows you to update the BIOS without using a DOS-based utility.



ASUS Q-Fan

ASUS Q-Fan technology intelligently adjusts CPU fan speeds according to system loading to ensure quiet, cool, and efficient operation.



ASUS Express Gate

With on 5 seconds boot-up time, the ASUS Express Gate allows you to instantly surf the Internet without entering Windows or the Hard Disk. You can now enjoy Skype, IM, YouTube, webmail and internet file downloads and sharing whenever and whatever you want.



- ASUS Express Gate supports file uploading from SATA HDDs, ODDs and USB drives and downloading to USB drives only.
- The actual boot time is subject to hardware configuration and product models.



AI NET2

AI NET2 remotely detects cable connection the second you turn on the system, and any faulty connections are reported back up to 100 meters at 1 meter accuracy.



Green ASUS

This motherboard and its packaging comply with the European Union's Restriction on the use of Hazardous Substances (RoHS). This is in line with the ASUS vision of creating environment-friendly and recyclable products/packaging to safeguard consumers' health while minimizing the impact on the environment.

1.4 Before you proceed

Take note of the following precautions before you install motherboard components or change any motherboard settings.



- Unplug the power cord from the wall socket before touching any component.
- Before handling components, use a grounded wrist strap or touch a safely grounded object or a metal object, such as the power supply case, to avoid damaging them due to static electricity.
- Hold components by the edges to avoid touching the ICs on them.
- Whenever you uninstall any component, place it on a grounded antistatic pad or in the bag that came with the component.
- Before you install or remove any component, switch off the ATX power supply and detach its power cord. Failure to do so may cause severe damage to the motherboard, peripherals, or components.

Onboard LED

The motherboard comes with a standby power LED that lights up to indicate that the system is ON, in sleep mode, or in soft-off mode. This is a reminder that you should shut down the system and unplug the power cable before removing or plugging in any motherboard component. The illustration below shows the location of the onboard LED.

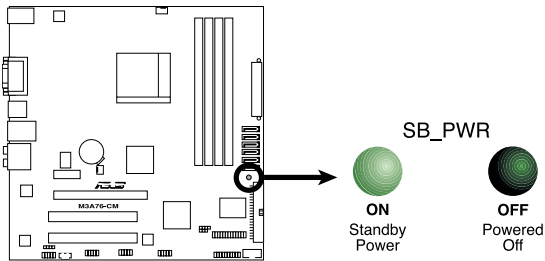

M3A76-CM Onboard LED

1.5 Motherboard overview

1.5.1 Placement direction

When installing the motherboard, ensure that you place it into the chassis in the correct orientation. The edge with external ports goes to the rear part of the chassis as indicated in the image below.

1.5.2 Screw holes

Place eight screws into the holes indicated by circles to secure the motherboard to the chassis.



Do not overtighten the screws! Doing so can damage the motherboard.

Place this side towards
the rear of the chassis.

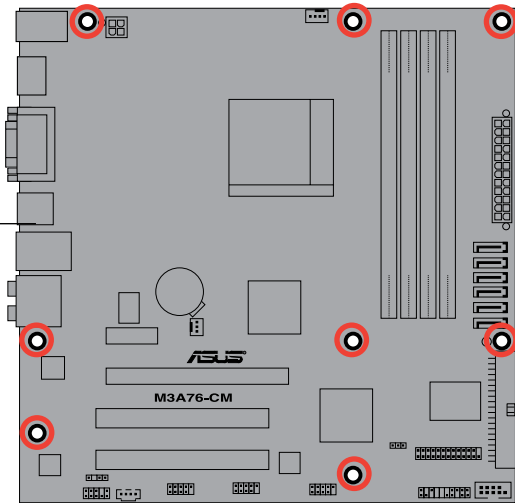

1.5.3 Motherboard layout

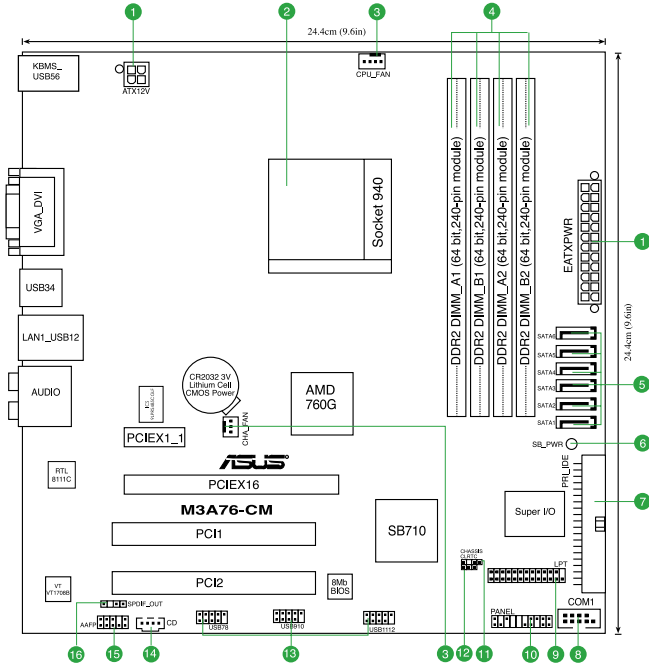

1.5.4 Layout contents

Connectors/Jumpers/Slots	Page	Connectors/Jumpers/Slots	Page
1. ATX power connectors (24-pin EATXPWR, 4-pin ATX12V)	1-21	9. LPT connector (26-1 pin LPT)	1-22
2. AM2/AM2+ CPU socket	1-8	10. System panel connector (20-8 pin PANEL)	1-23
3. CPU, CHASSIS fan connectors (4-pin CPU_FAN, 3-pin CHA_FAN)	1-24	11. Chassis intrusion connector	1-26
4. DDR2 DIMM slots	1-11	12. Clear RTC RAM (CLR_RTC)	1-17
5. Serial ATA connectors (7-pin SATA1-6)	1-22	13. USB connectors (10-1 pin USB78, USB910, USB1112)	1-24
6. Onboard LED	1-5	14. Optical drive audio connector (4-pin CD)	1-21
7. IDE connector (40-1 pin PRI_IDE)	1-20	15. Front panel audio connector (10-1 pin AAFP)	1-25
8. Serial port connector (10-1 pin COM1)	1-20	16. Digital audio connector (4-1 pin SPDIF_OUT)	1-25

1.6 Central Processing Unit (CPU)

The motherboard comes with an AM2+ / AM2 socket designed for AMD® AM2+ / AM2 Phenom™ FX / Phenom™ / Athlon™ / Sempron™ processor.



The AM2/AM2+ socket has a different pinout from the 940-pin socket designed for the AMD Opteron™ processor. Use a CPU that is designed for the AM2/AM2+ socket.

1.6.1 Installing the CPU

To install a CPU:

1. Locate the CPU socket on the motherboard.

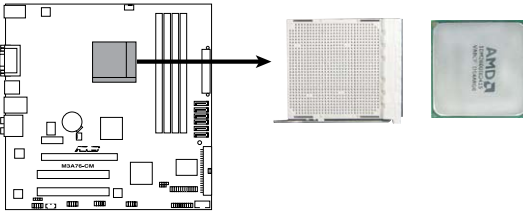

M3A76-CM CPU Socket 940

2. Press the lever sideways to unlock the socket, then lift it up to a 90°-100° angle.

Socket lever

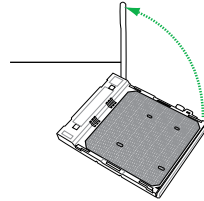

Ensure that the socket lever is lifted up to 90°-100° angle, otherwise the CPU will not fit in completely.

- Position the CPU above the socket such that the CPU corner with the gold triangle matches the socket corner with a small triangle.
- Carefully insert the CPU into the socket until it fits in place.



The CPU fits only in one correct orientation. DO NOT force the CPU into the socket to prevent bending the pins and damaging the CPU!

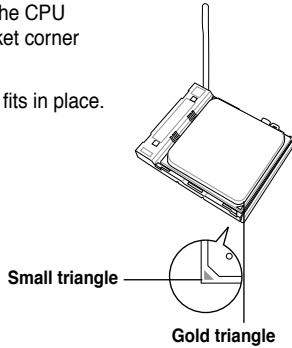

- When the CPU is in place, push down the socket lever to secure the CPU. The lever clicks on the side tab to indicate that it is locked.
- Install a CPU heatsink and fan following the instructions that came with the heatsink package. You can also refer to section **1.6.2 Installing heatsink and fan** for instructions.

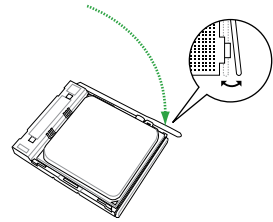

- Connect the CPU fan cable to the CPU_FAN connector on the motherboard.

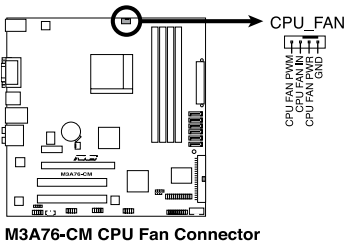

Do not forget to connect the CPU fan connector! Hardware monitoring errors can occur if you fail to plug this connector.

1.6.2 Installing the heatsink and fan



Ensure that you use only AMD-certified heatsink and fan assembly.

To install the CPU heatsink and fan:

1. Place the heatsink on top of the installed CPU, making sure that the heatsink fits properly on the retention module base.



- The retention module base is already installed on the motherboard upon purchase.
- You do not have to remove the retention module base when installing the CPU or installing other motherboard components.
- If you purchased a separate CPU heatsink and fan assembly, ensure that a Thermal Interface Material is properly applied to the CPU heatsink or CPU before you install the heatsink and fan assembly.

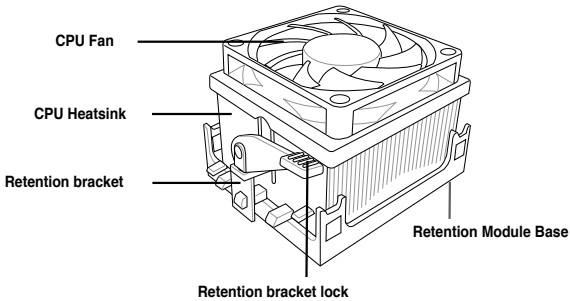

Your boxed CPU heatsink and fan assembly should come with installation instructions for the CPU, heatsink, and the retention mechanism. If the instructions in this section do not match the CPU documentation, follow the latter.

2. Attach one end of the retention bracket to the retention module base.

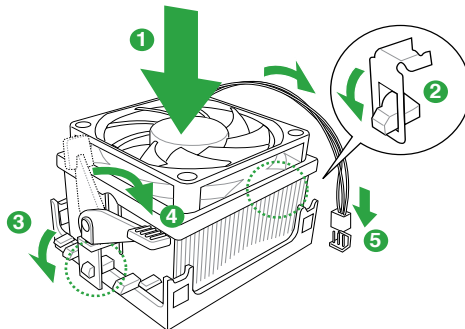

- Align the other end of the retention bracket to the retention module base. A clicking sound denotes that the retention bracket is in place.



Ensure that the fan and heatsink assembly perfectly fits the retention mechanism module base, otherwise you cannot snap the retention bracket in place.

- Push down the retention bracket lock on the retention mechanism to secure the heatsink and fan to the module base.
- When the fan and heatsink assembly is in place, connect the CPU fan cable to the connector on the motherboard labeled CPU_FAN.



Do not forget to connect the CPU fan connector! Hardware monitoring errors can occur if you fail to plug this connector.

1.7 System memory

1.7.1 Overview

The motherboard comes with four Double Data Rate 2 (DDR2) Dual Inline Memory Modules (DIMM) sockets. A DDR2 module has the same physical dimensions as a DDR DIMM but has a 240-pin footprint compared to the 184-pin DDR DIMM. DDR2 DIMMs are notched differently to prevent installation on a DDR DIMM socket. The figure illustrates the location of the DDR2 DIMM sockets:

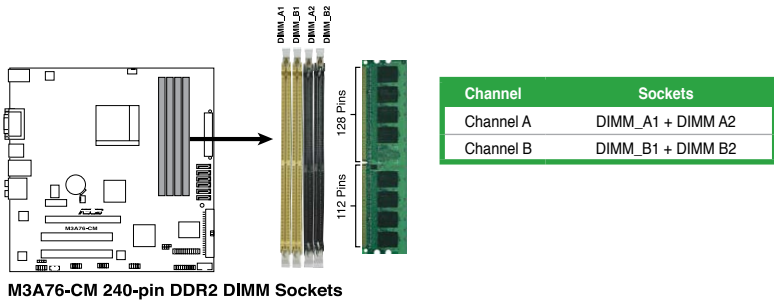

1.7.2 Memory configurations

You may install 512MB, 1GB and 2GB unbuffered ECC/non-ECC DDR2 DIMMs into the DIMM sockets.



- You may install varying memory sizes in Channel A and Channel B. The system maps the total size of the lower-sized channel for the dual-channel configuration. Any excess memory from the higher-sized channel is then mapped for single-channel operation.
- Always install DIMMs with the same CAS latency. For optimum compatibility, we recommend that you obtain memory modules from the same vendor.
- Due to the memory address limitation on 32-bit Windows® OS, when you install 4GB or more memory on the motherboard, the actual usable memory for the OS can be about 3GB or less. For effective use of memory, we recommend that you do any of the following:
 - Use a maximum of 3GB system memory if you are using a 32-bit Windows® OS.
 - Install a 64-bit Windows® OS when you want to install 4GB or more memory on the motherboard.
- This motherboard does not support DIMMs made up of 256 megabits (Mb) or less.



The motherboard supports up to 8GB memory modules on Windows® XP Professional x64 and Vista x64 editions. You may install a maximum of 2 GB DIMMs on each slot.

M3A76-CM Motherboard Qualified Vendors Lists (QVL)

DDR2-1066MHz capability

Size	Vendor	Part No.	CL	Chip Brand	SS/DS	Chip No.	DIMM support (Optional)		
							A*	B*	C*
512MB	Kingston	KVR1066D2N7/512	N/A	Elpida	SS	E5108AJBG-1J-E		•	•
1G	Kingston	KHX8500D2/1G	N/A	Kingston	DS	Heat-Sink Package		•	•
1G	Qimonda	HYS64T128020EU-19F-C	6	Qimonda	DS	HYB18T512800CF19FFSS24313		•	•
1G	Kingmax	KLED48F-A8K15	N/A	Kingmax	DS	KA8FFIXF-JFS-18A		•	•
1G	Transcend	TX1066QLJ-2GK1GB	5	Transcend	DS	Heat-Sink Package		•	•
1G	OCZ	OCZ2N1066SR2DK	N/A	OCZ	DS	Heat-Sink Package		•	•
1G	GEIL	GE22GB1066C5DC	5	GEIL	DS	Heat-Sink Package		•	•
1G	GEIL	GE24GB1066C5QC	5	GEIL	DS	Heat-Sink Package		•	•



- Due to AM2+ CPU limitation, only one DDR2 1066 DIMM is supported per channel. When two DDR2 1066 DIMMs are installed, all DIMMs run at 800Mhz frequency by default for system stability.
- The default DIMM frequency depends on its Serial Presence Detect (SPD), which is the standard way of accessing information from a memory module. Under the default state, some memory modules for overclocking may operate at a lower frequency than the vendor-marked value.

DDR2-800MHz capability

Size	Vendor	Part No.	CL	Chip Brand	SS/DS	Chip No.	DIMM support (Optional)		
							A*	B*	C*
1G	Kingston	KHX6400D2LL1/G	N/A	Kingston	DS	Heat-Sink Package		•	•
512MB	Kingston	KVR800D2N5/512	N/A	Promos	SS	V59C1512804QCF25Y03206PECPA		•	•
2G	Kingston	KHX6400D2/2G	N/A	Kingston	DS	Heat-Sink Package		•	•
4G	Kingston	KVR800D2N6/4G	N/A	Elpida	DS	E2108ABSE-8G-E		•	•
512MB	Samsung	M378T6553GZS-CF7	6	Samsung	SS	K4T51083QG-HCF7		•	•
2G	Samsung	M378T5663QZ3-CF7	6	Samsung	DS	K4T1G084QQ-HCF7		•	•
2G	Samsung	M391T5663QZ3-CF7	6	Samsung	DS	K4T1G084QQ-HCF7(ECC)		•	•
512MB	Qimonda	HYS64T64000EU-2.5-B2	6	Qimonda	SS	HYB18T512800B2F25FSS28380		•	•
1G	Micron	MT9HTF12872AY-800E1	6	Micron	SS	D9HNP 7YE22(ECC)		•	•
1G	Corsair	XMS2-6400	4	Corsair	DS	Heat-Sink Package		•	•
512MB	HY	HYMP564U64CP8-S5 AB	5	Hynix	SS	HY5PS12821CFP-S5		•	•
1G	HY	HYMP512U64CP8-S5 AB	5	Hynix	DS	HY5PS12821CFPS5		•	•
512MB	Kingmax	KLDC28F-A8K15	N/A	Kingmax	SS	KK48FF1XF-JFS-25A		•	•
1G	Kingmax	KLDD48F-A8K15	N/A	Kingmax	DS	KK48FF1XF-HFS-25A		•	•
512MB	Apacer	78.91G91.9K5	5	Apacer	SS	AM4B5708JQS8E0751C		•	•
2G	Apacer	78.A1G0.9K4	5	Apacer	DS	AM4B5808CQJS8E0740E		•	•
512MB	Transcend	TS128ML064V8J512MB	N/A	Micron	SS	7HD22 D9GMH		•	•
1G	Transcend	505485-1034	5	Transcend	DS	TQ123PJF8F0801		•	•
512MB	VDATA	M2GVD6G3H3160Q1E52	N/A	VDATA	SS	VD29608A8A-25EG20813		•	•
1G	ADATA	M2OAD6G314170Q1E58	N/A	ADATA	DS	AD29608A8A-25EG80810		•	•
2G	PSC	AL8E8F73C-8E1	5	PSC	DS	A3R1GE3CFF734MAA0E		•	•
2G	PSC	AL7E8E63H-10E1K	5	PSC	DS	A3R1GE3CFF750RABBP(ECC)		•	•
1G	GEIL	GX22GB6400DC	5	GEIL	DS	Heat-Sink Package		•	•
2G	GEIL	GE28GB800C5QC	5	GEIL	DS	Heat-Sink Package		•	•
1G	Super Talent	T800UB1GC4	4	Super Talent	DS	Heat-Sink Package		•	•
1G	G.SKILL	F2-6400CL4D-2GBPK	4	G.SKILL	DS	Heat-Sink Package		•	•
2G	G.SKILL	F2-6400CL5D-4GBPQ	5	G.SKILL	DS	Heat-Sink Package		•	•
4G	G.SKILL	F2-6400CL5Q-16GNQ	5	G.SKILL	DS	Heat-Sink Package		•	•
1G	OCZ	OCZ2VU8004GK	6	OCZ	DS	Heat-Sink Package		•	•
1G	Elixir	M2Y1G64TU8HB0B-25C	5	Elixir	DS	N2TU51280BE-25C852006Z1DV		•	•

DDR2-667MHz capability

Size	Vendor	Part No.	CL	Chip Brand	SS/DS	Chip No.	DIMM support (Optional)		
							A*	B*	C*
512MB	Kingston	KVR667D2N5/512	N/A	Hynix	SS	HY5PS12821EFP-Y5		•	•
1G	Kingston	KVR667D2N5/1G	N/A	Hynix	DS	HY5PS12821EFP-Y5		•	•
512MB	Qimonda	HYS64T64000EU-3S-B2	5	Qimonda	SS	HYB18T512B00B2F3SFSS28171		•	•
1G	Qimonda	HYS64T128020EU-3S-B2	5	Qimonda	DS	HYB18T512B00B2F3SFSS28171		•	•
1G	Corsair	XMS2-5400	4	Corsair	DS	Heat-Sink Package		•	•
512MB	Kingmax	KLCC28F-A8KB5	N/A	Kingmax	SS	KKEA88B4LAUG-29DX		•	•
1G	Kingmax	KLCD48F-A8KB5	N/A	Kingmax	DS	KKEA88B4LAUG-29DX		•	•
512MB	Apacer	78.91G92.9K5	5	Apacer	SS	AM4B5708JQS7E0751C		•	•
1G	Apacer	AU01GE667C5KBCG	N/A	Apacer	DS	AM4B5708JQS7E0636B		•	•
2G	Apacer	78.A1G90.9K4	5	Apacer	DS	AM4B5808CQJS7E0749B		•	•
1G	Transcend	506010-4894	5	Elpida	DS	E5108AJBG-6E-E		•	•
1G	ADATA	M2OAD5G314170Q1C58	N/A	ADATA	DS	AD29608A8A-3EG80814		•	•
2G	ADATA	M2OAD5H3J4170I1C53	N/A	ADATA	DS	AD20908A8A-3EG 30724		•	•
512MB	PSC	AL6E8E63J-6E1	5	PSC	SS	A3R12E3JFF717B9A00		•	•
1G	PSC	AL7E8F73C-6E1	5	PSC	SS	A3R1GE3CFF734MAA0J		•	•
512MB	Nanya	NT512T64U88A1BY-3C	N/A	Nanya	SS	NT5U64MAE-3C		•	•
1G	GEIL	GX21GB5300SX	3	GEIL	DS	Heat-Sink Package		•	•
2G	GEIL	GX24GB5300LDC	5	GEIL	DS	Heat-Sink Package		•	•
512MB	Twinmos	8D-A3JK5MPETP	5	PSC	SS	A3R12E3GEF633ACA0Y		•	•
1G	Leadmax	LRMP512U64A8-Y5	N/A	Hynix	DS	HY5PS12821CFP-Y5 C 702AA		•	•

DDR2-533MHz capability

Size	Vendor	Part No.	CL	Chip Brand	SS/ DS	Chip No.	DIMM support (Optional)		
							A*	B*	C*
512MB	Kingston	KVR533D2N4/512	N/A	Infineon	SS	HYB18T512800AF3733336550	•	•	
1G	Kingston	KVR533D2N4/1G	N/A	Hynix	DS	HY5PS12821EFP-Y5		•	•
1G	HY	HYP512U64CP8-C4 AB	4	Hynix	DS	HY5PS12821CFP-C4		•	•
512MB	Elpida	EBE51UD8ABFA-5C-E	N/A	Elpida	SS	E5108AB-5C-E		•	•
512MB	Transcend	512MB DDR2 533 ECC	N/A	Micron	SS	6ND22D9GCT(ECC)		•	•
512MB	Kingmax	KLBC28F-A8KB4	N/A	Kingmax	SS	KKEA88B4IAK-37		•	•



SS - Single-sided / DS - Double - sided

DIMM support:

- **A***: Supports one module inserted into any slot as Single-channel memory configuration.
- **B***: Supports one pair of modules inserted into both the yellow slots as one pair of Dual-channel memory configuration.
- **C***: Supports four modules inserted into both the yellow slots and the black slots as two pairs of Dual-channel memory configuration.



Visit the ASUS website at www.asus.com for the latest DDR2-533/667/800/1066MHz QVL.

1.7.3 Installing a DIMM



Unplug the power supply before adding or removing DIMMs or other system components. Failure to do so can cause severe damage to both the motherboard and the components.

1. Press the retaining clips outward to unlock a DDR2 DIMM socket.
2. Align a DIMM on the socket such that the notch on the DIMM matches the break on the socket.

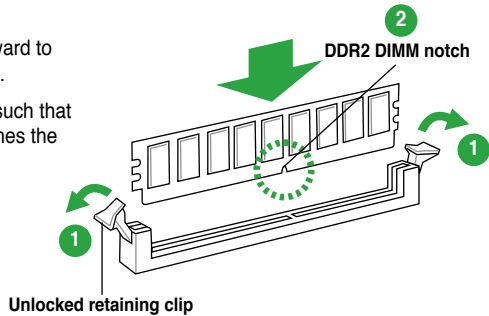

A DDR2 DIMM is keyed with a notch so that it fits in only one direction. DO NOT force a DIMM into a socket to avoid damaging the DIMM.

3. Firmly insert the DIMM into the socket until the retaining clips snap back in place and the DIMM is properly seated.

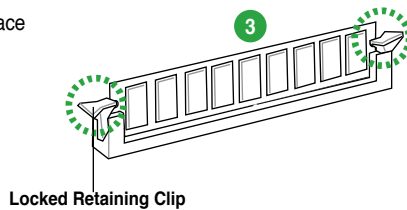

1.6.4 Removing a DIMM

To remove a DIMM:

1. Simultaneously press the retaining clips outward to unlock the DIMM.



Support the DIMM lightly with your fingers when pressing the retaining clips. The DIMM might get damaged when it flips out with extra force.

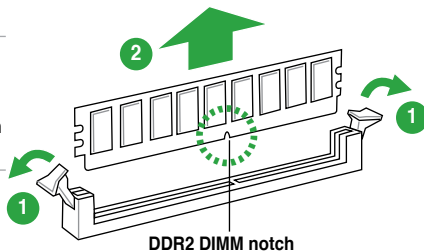

2. Remove the DIMM from the socket.

1.8 Expansion slots

In the future, you may need to install expansion cards. The following sub-sections describe the slots and the expansion cards that they support.



Unplug the power cord before adding or removing expansion cards. Failure to do so may cause you physical injury and damage motherboard components.

1.8.1 Installing an expansion card

To install an expansion card:

1. Before installing the expansion card, read the documentation that came with it and make the necessary hardware settings for the card.
2. Remove the system unit cover (if your motherboard is already installed in a chassis).
3. Remove the bracket opposite the slot that you intend to use. Keep the screw for later use.
4. Align the card connector with the slot and press firmly until the card is completely seated on the slot.
5. Secure the card to the chassis with the screw you removed earlier.
6. Replace the system cover.

1.8.2 Configuring an expansion card

After installing the expansion card, configure it by adjusting the software settings.

1. Turn on the system and change the necessary BIOS settings, if any. See Chapter 2 for information on BIOS setup.
2. Assign an IRQ to the card.
3. Install the software drivers for the expansion card.



When using PCI cards on shared slots, ensure that the drivers support "Share IRQ" or that the cards do not need IRQ assignments. Otherwise, conflicts will arise between the two PCI groups, making the system unstable and the card inoperable.

1.8.4 PCI slots

The PCI slots support cards such as a LAN card, SCSI card, USB card, and other cards that comply with PCI specifications.

1.8.5 PCI Express x1 slot

This motherboard supports PCI Express x1 network cards, SCSI cards, and other cards that comply with the PCI Express specifications.

1.8.6 PCI Express x16 slot

This motherboard supports a PCI Express x16 graphics card that complies with the PCI Express specifications.

1.9 Jumpers

1. Clear RTC RAM (CLRRTC)

This jumper allows you to clear the Real Time Clock (RTC) RAM in CMOS. You can clear the CMOS memory of date, time, and system setup parameters by erasing the CMOS RTC RAM data. The onboard button cell battery powers the RAM data in CMOS, which include system setup information such as system passwords.

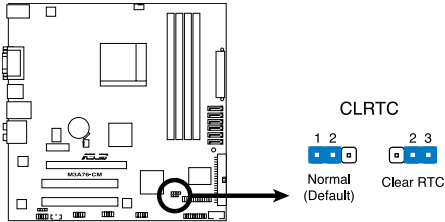

M3A76-CM Clear RTC RAM

To erase the RTC RAM:

1. Turn OFF the computer and unplug the power cord.
2. Move the jumper cap from pins 1-2 (default) to pins 2-3. Keep the cap on pins 2-3 for about 5~10 seconds, then move the cap back to pins 1-2.
3. Plug the power cord and turn ON the computer.
4. Hold down the **** key during the boot process and enter BIOS setup to reenter data.



Except when clearing the RTC RAM, never remove the cap on CLRRTC jumper default position. Removing the cap will cause system boot failure!



- If the steps above do not help, remove the onboard battery and move the jumper again to clear the CMOS RTC RAM data. After clearing the CMOS, reinstall the battery.
 - You do not need to clear the RTC when the system hangs due to overclocking. For system failure due to overclocking, use the CPU Parameter Recall (C.P.R) feature. Shut down and reboot the system so the BIOS can automatically reset parameter settings to default values.
-

1.10 Connectors

1.10.1 Rear panel connectors

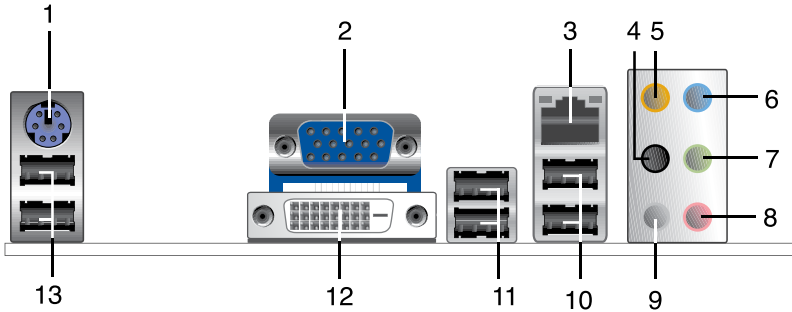

1. **PS/2 Keyboard port (purple).** This port is for a PS/2 keyboard / mouse.
2. **Video Graphics Adapter (VGA) port.** This 15-pin port is for a VGA monitor or other VGA-compatible devices.
3. **LAN (RJ-45) port.** This port allows Gigabit connection to a Local Area Network (LAN) through a network hub.

LAN port LED indications

Activity/Link LED		Speed LED	
Status	Description	Status	Description
OFF	No link	OFF	10 Mbps connection
ORANGE	Linked	ORANGE	100 Mbps connection
BLINKING	Data activity	GREEN	1 Gbps connection

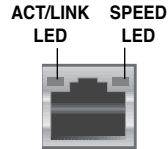

LAN port

4. **Rear Speaker Out port (black).** This port connects the rear speakers in a 4-channel, 6-channel, or 8-channel audio configuration.
5. **Center / Subwoofer port (orange).** This port connects the center/subwoofer speakers.
6. **Line In port (light blue).** This port connects the tape, CD, DVD player, or other audio sources.
7. **Line Out port (lime).** This port connects a headphone or a speaker. In 4-channel, 6-channel, and 8-channel configurations, the function of this port becomes Front Speaker Out.
8. **Microphone port (pink).** This port connects a microphone.
9. **Side Speaker Out port (gray).** This port connects the side speaker in an 8-channel audio configuration.



Refer to the audio configuration table on next page for the function of the audio ports in 2, 4, 6, or 8-channel configuration.

Audio 2, 4, 6, 8-channel configuration

Port	Headset 2-channel	4-channel	6-channel	8-channel
Light Blue	Line In	Line in	Line in	Line in
Lime	Line Out	Front Speaker Out	Front Speaker Out	Front Speaker Out
Pink	Mic In	Mic In	Mic in	Mic in
Orange	-	-	Center/Subwoofer	Center/Subwoofer
Black	-	Rear Speaker Out	Rear Speaker Out	Rear Speaker Out
Gray	-	-	-	Side Speaker Out



Ensure that the audio device of Sound playback is **VIA High Definition Audio (the name may be different based on the OS)**. Go to **Start > Control Panel > Sounds and Audio Devices > Sound Playback** to configure the setting.

10. **USB 2.0 ports 1 and 2.** These two 4-pin Universal Serial Bus (USB) ports are available for connecting USB 2.0 devices.
11. **USB 2.0 ports 3 and 4.** These two 4-pin Universal Serial Bus (USB) ports are available for connecting USB 2.0 devices.
12. **DVI-D Out port.** This port is for any DVI-D compatible device and is HDCP compliant allowing playback of HD DVD, Blu-Ray and other protected content.



To ensure high visual quality, install Windows Media Player 11 or later versions when you connect a display monitor to the DisplayPort, VGA, or DVI port, or when you connect two display monitors to any two of these three ports.

13. **USB 2.0 ports 5 and 6.** These two 4-pin Universal Serial Bus (USB) ports are available for connecting USB 2.0 devices.

1.10.2 Internal connectors

1. Serial port connector (10-1 pin COM1)

The connector is for a serial (COM) port. Connect the serial port module cable to the connector, then install the module to a slot opening at the back of the system chassis.



The serial port bracket (COM1) is purchased separately.

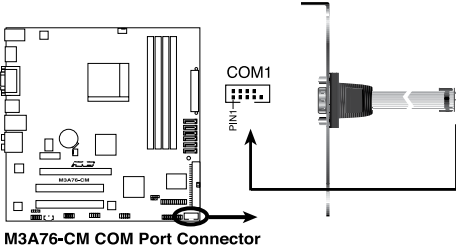

2. IDE connector (40-1 pin PRI_IDE)

The onboard IDE connector is for an Ultra DMA 133/100/66 signal cable. There are three connectors on each Ultra DMA 133/100/66 signal cable: blue, black, and gray. Connect the blue connector to the motherboard's IDE connector, then select one of the following modes to configure your device(s).

	Drive jumper setting	Mode of device(s)	Cable connector
Single device	Cable-Select or Master	-	Black
Two devices	Cable-Select	Master	Black
		Slave	Gray
	Master	Master	Black or gray
	Slave	Slave	



- Pin 20 on the IDE connector is removed to match the covered hole on the Ultra DMA cable connector. This prevents incorrect insertion when you connect the IDE cable.
- Use the 80-conductor IDE cable for Ultra DMA 133/100/66 IDE devices.



If any device jumper is set as "Cable-Select," make sure all other device jumpers have the same setting.

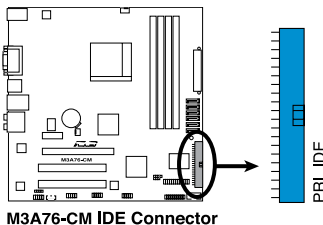

3. ATX power connectors (24-pin EATXPWR, 4-pin ATX12V)

These connectors are for an ATX power supply. The plugs from the power supply are designed to fit these connectors in only one orientation. Find the proper orientation and push down firmly until the connectors completely fit.

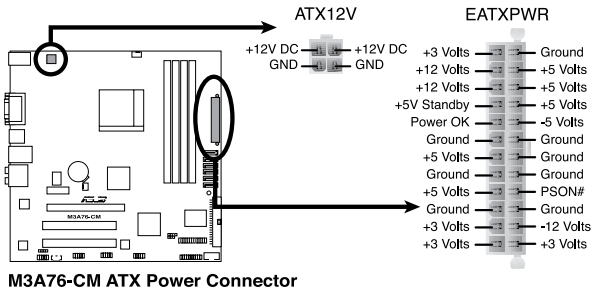

M3A76-CM ATX Power Connector



- We recommend that you use an ATX 12 V Specification 2.0-compliant power supply unit (PSU) with a minimum of 300 W power rating. This PSU type has 24-pin and 4-pin power plugs.
- If you intend to use a PSU with 20-pin and 4-pin power plugs, ensure that the 20-pin power plug can provide at least 15 A on +12 V and that the PSU has a minimum power rating of 300 W. The system may become unstable or may not boot up if the power is inadequate.
- Do not forget to connect the 4-pin ATX +12 V power plug. Otherwise, the system will not boot up.
- We recommend that you use a PSU with higher power output when configuring a system with more power-consuming devices or when you intend to install additional devices. The system may become unstable or may not boot up if the power is inadequate.
- If you are uncertain about the minimum power supply requirement for your system, refer to the Recommended Power Supply Wattage Calculator at <http://support.asus.com/PowerSupplyCalculator/PSCalculator.aspx?SLanguage=en-us> for details.

5. Serial ATA connectors (7-pin SATA1, SATA2, SATA3, SATA4, SATA5, SATA6)

These connectors are for the Serial ATA signal cables for Serial ATA 3Gb/s hard disk and optical disk drives. The Serial ATA 3Gb/s is backward compatible with Serial ATA 1.5Gb/s specification. The data transfer rate of the Serial ATA 3Gb/s is faster than the standard parallel ATA with 133 MB/s (Ultra DMA133).

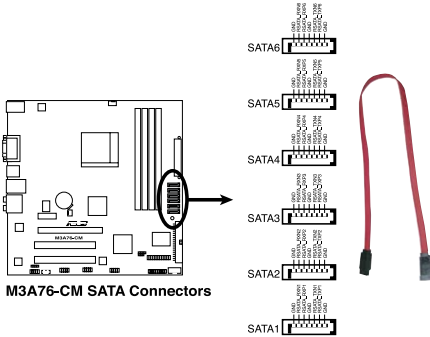

M3A76-CM SATA Connectors



Install the Windows® XP Service Pack 2 or later version before using Serial ATA.



- If you want to do the task as GHOST, we suggest you connect the original disk to the SATA5 or SATA6

6. LPT connector

The LPT (Line Printing Terminal) connector supports devices such as a printer. LPT standardizes as IEEE 1284, which is the parallel port interface on IBM PC-compatible computers.

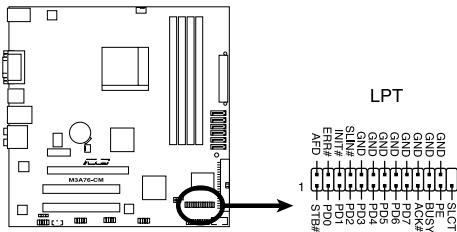

M3A76-CM Parallel Port Connector

7. System panel connector (20-8 pin PANEL)

This connector supports several chassis-mounted functions.

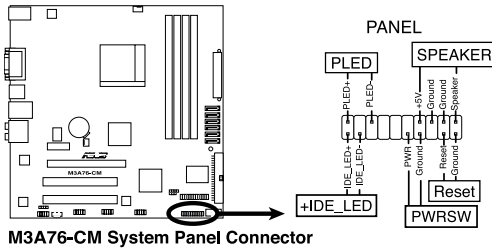

- **System power LED (2-pin PLED)**
This 2-pin connector is for the system power LED. Connect the chassis power LED cable to this connector. The system power LED lights up when you turn on the system power, and blinks when the system is in sleep mode.
- **Hard disk drive activity LED (2-pin IDE_LED)**
This 2-pin connector is for the HDD Activity LED. Connect the HDD Activity LED cable to this connector. The IDE LED lights up or flashes when data is read from or written to the HDD.
- **Power/Soft-off button (2-pin PWRSW)**
This 2-pin connector is for the system power button. Pressing the power button turns the system ON or puts the system in SLEEP or SOFT-OFF mode depending on the BIOS settings. Pressing the power switch for more than four seconds while the system is ON turns the system OFF.
- **Reset button (2-pin RESET)**
This 2-pin connector is for the chassis-mounted reset button for system reboot without turning off the system power.
- **System warning speaker (2-pin SPEAKER)**
This 4-pin connector is for the chassis-mounted system warning speaker. The speaker allows you to hear system beeps and warnings.

8. USB connectors (10-1 pin USB78, USB910, USB1112)

These connectors are for USB 2.0 ports. Connect the USB module cable to any of these connectors, then install the module to a slot opening at the back of the system chassis. These USB connectors comply with USB 2.0 specification that supports up to 480 Mbps connection speed.

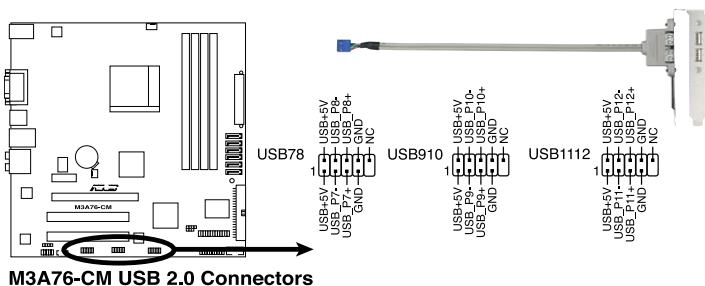

Never connect a 1394 cable to the USB connectors. Doing so will damage the motherboard!



The USB 2.0 module is purchased separately.

9. CPU and Chassis Fan connectors (4 pin CPU_FAN, 3-pin CHA_FAN)

The fan connectors support cooling fans of 350mA~740mA (8.88W max.) or a total of 1A~2.22A (26.64W max.) at +12V. Connect the fan cables to the fan connectors on the motherboard, ensuring that the black wire of each cable matches the ground pin of the connector.



DO NOT forget to connect the fan cables to the fan connectors. Insufficient air flow inside the system may damage the motherboard components. These are not jumpers! DO NOT place jumper caps on the fan connectors.



Only the CPU FAN supports ASUS Q-Fan.

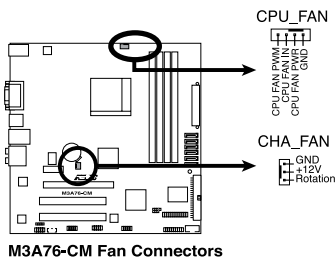

10. Front panel audio connector (10-1 pin AAFP)

This connector is for a chassis-mounted front panel audio I/O module that supports either High Definition Audio or AC'97 audio standard. Connect one end of the front panel audio I/O module cable to this connector.

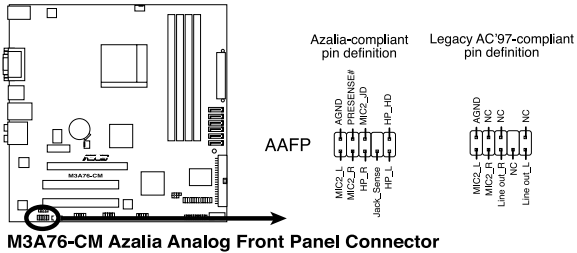

- We recommend that you connect a high-definition front panel audio module to this connector to avail of the motherboard high-definition audio capability.
- By default, this connector is set to **[HD Audio]**. If you want to connect a High Definition front panel audio module to this connector, set the **Front Panel Select** item in the BIOS to **[HD Audio]**. See section "2.4.3 Chipset" for details.

11. Digital audio connector (4-1 pin SPDIF_OUT)

This connector is for an additional Sony/Philips Digital Interface (S/PDIF) ports.

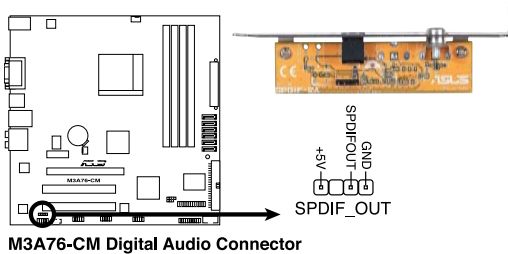

The S/PDIF module is purchased separately.

12. Optical drive audio in connector (4-pin CD)

This connector allows you to receive stereo audio input from sound sources such as a CD-ROM, TV tuner, or MPEG card.

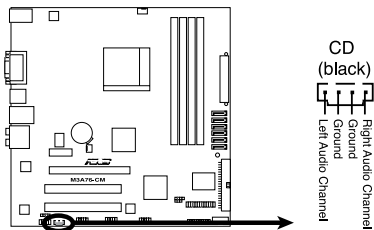

M3A76-CM Internal Audio Connector

13. Chassis intrusion connector (4-1 pin CHASSIS)

This connector is for a chassis-mounted intrusion detection sensor or switch. Connect one end of the chassis intrusion sensor or switch cable to this connector. The chassis intrusion sensor or switch sends a high-level signal to this connector when a chassis component is removed or replaced. The signal is then generated as a chassis intrusion event.

By default, the pin labeled “Chassis Signal” and “Ground” are shorted with a jumper cap. Remove the jumper caps only when you intend to use the chassis intrusion detection feature.

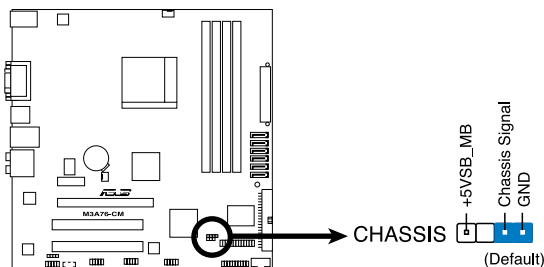

M3A76-CM Intrusion Connector

1.11 Software support

1.11.1 Installing an operating system

This motherboard supports Windows® XP/Vista Operating Systems (OS). Always install the latest OS version and corresponding updates to maximize the features of your hardware.



- Motherboard settings and hardware options vary. Use the setup procedures presented in this chapter for reference only. Refer to your OS documentation for detailed information.
- Ensure that you install Windows® XP Service Pack 3 or later versions/ Windows® Vista Service Pack 1 or later versions before installing the drivers for better compatibility and system stability.

1.11.2 Support DVD information

The Support DVD that comes with the motherboard package contains the drivers, software applications, and utilities that you can install to avail all motherboard features.



The contents of the Support DVD are subject to change at any time without notice. Visit the ASUS website at www.asus.com for updates.

To run the Support DVD

Place the Support DVD to the optical drive. The DVD automatically displays the Drivers menu if Autorun is enabled in your computer.

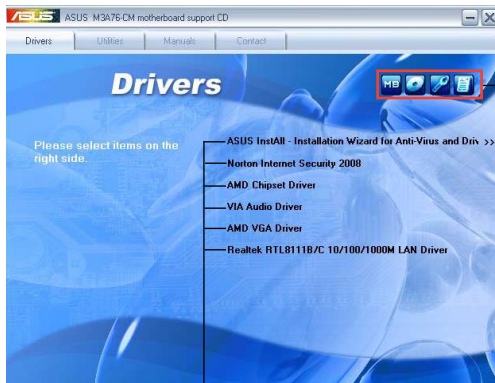

Click an icon to display Support DVD/ motherboard information

Click an item to install



If Autorun is NOT enabled in your computer, browse the contents of the Support DVD to locate the file ASSETUP.EXE from the BIN folder. Double-click the ASSETUP.EXE to run the DVD.

Chapter 2

BIOS information

2.1 Managing and updating your BIOS



Save a copy of the original motherboard BIOS file to a USB flash disk in case you need to restore the BIOS in the future. Copy the original motherboard BIOS using the ASUS Update or AFUDOS utilities.

2.1.1 ASUS Update utility

The ASUS Update is a utility that allows you to manage, save, and update the motherboard BIOS in Windows® environment.



-
- ASUS Update requires an Internet connection either through a network or an Internet Service Provider (ISP).
 - This utility is available in the support DVD that comes with the motherboard package.
-

Installing ASUS Update

To install ASUS Update:

1. Place the support DVD in the optical drive. The **Drivers** menu appears.
2. Click the **Utilities** tab, then click **Install ASUS Update**.
3. Follow the onscreen instructions to complete the installation.



Quit all Windows® applications before you update the BIOS using this utility.

Updating the BIOS

To update the BIOS:

1. From the Windows® desktop, click **Start > Programs > ASUS > ASUSUpdate > ASUSUpdate** to launch the ASUS Update utility.
2. From the dropdown list, select any of the updating process:

Updating from the Internet

- a. Select **Update BIOS from the Internet**, then click **Next**.
- b. Select the ASUS FTP site nearest you to avoid network traffic, or click **Auto Select** then click **Next**.
- c. From the FTP site, select the BIOS version that you wish to download then click **Next**.



The ASUS Update utility is capable of updating itself through the Internet. Always update the utility to avail all its features.

Updating from a BIOS file

- a. Select **Update BIOS from a file**, then click **Next**.
 - b. Locate the BIOS file from the **Open** window, then click **Open**.
3. Follow the onscreen instructions to complete the updating process.

2.1.2 ASUS EZ Flash 2 utility

The ASUS EZ Flash 2 feature allows you to update the BIOS without having to use a DOS-based utility.



Before using this utility, download the latest BIOS file from the ASUS website at www.asus.com.

To update the BIOS using EZ Flash 2:

1. Insert the USB flash disk that contains the latest BIOS file to the USB port, then launch EZ Flash 2. You can launch EZ Flash 2 in two ways.
 - a. Press **<Alt> + <F2>** during POST to display the following:

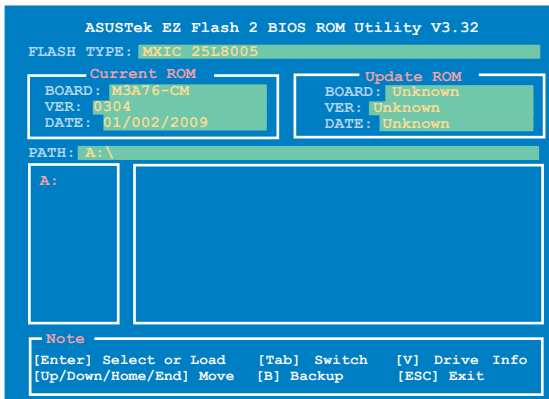

- Enter the BIOS setup program. Go to the **Tools** menu to select **EZ Flash 2** and press **<Enter>** to enable it.
Press **<Tab>** to switch between drives until the correct BIOS file is found.
4. When the correct BIOS file is found, EZ Flash 2 performs the BIOS update process and automatically reboots the system when done.



- Only a USB flash disk with **FAT 32/16** format and single partition can support the ASUS EZ Flash 2 utility.
- Do not shut down or reset the system while updating the BIOS to prevent system boot failure!

2.1.3 ASUS CrashFree BIOS 3 utility

The ASUS CrashFree BIOS 3 is an auto recovery tool that allows you to restore the BIOS file when it fails or gets corrupted during the updating process. You can update a corrupted BIOS file using the motherboard support DVD or a USB flash disk that contains the updated BIOS file.



- Prepare the motherboard support DVD or the USB flash disk containing the updated motherboard BIOS before using this utility.
- Always connect the SATA cable to the SATA1 / SATA 2 connector. Otherwise, the utility will not function.

Recovering the BIOS

To recover the BIOS:

1. Turn on the system.
2. Insert the support DVD or USB flash disk containing the BIOS file to the optical drive or USB port.
3. The utility displays the following message and automatically checks the support DVD or USB flash disk for the BIOS file.

```
Bad BIOS checksum. Starting BIOS recovery...
Checking for CD-ROM...
CD-ROM not found!
Checking for USB Device...
```

When found, the utility reads the BIOS file and starts erasing the corrupted BIOS file.

```
Bad BIOS checksum. Starting BIOS recovery...
Checking for USB Device...
USB Device found.
Reading file "M3A76CM.ROM". Completed.
Start Erasing...\
```

4. Restart the system after the utility completes the updating process.



- Only a USB flash disk with FAT 32/16 format and single partition can support ASUS CrashFree BIOS 3. The device size should be smaller than 8GB.
- DO NOT shut down or reset the system while updating the BIOS! Doing so can cause system boot failure!



The recovered BIOS may not be the latest BIOS version for this motherboard. Download the latest BIOS file from the ASUS website at www.asus.com.

2.2 BIOS setup program

This motherboard supports a programmable Serial Peripheral Interface (SPI) chip that you can update using the provided utility described in section “2.1 Managing and updating your BIOS.”

Use the BIOS Setup program when you are installing a motherboard, reconfiguring your system, or prompted to “Run Setup.” This section explains how to configure your system using this utility.

Even if you are not prompted to use the Setup program, you can change the configuration of your computer in the future. For example, you can enable the security password feature or change the power management settings. This requires you to reconfigure your system using the BIOS Setup program so that the computer can recognize these changes and record them in the CMOS RAM of the SPI chip.

The SPI chip on the motherboard stores the Setup utility. When you start up the computer, the system provides you with the opportunity to run this program. Press **** during the Power-On Self-Test (POST) to enter the Setup utility. Otherwise, POST continues with its test routines.

If you wish to enter Setup after POST, reboot the system by doing any of the following procedures:

- Restart using the OS standard shutdown procedure.
- Press **<Ctrl>+<Alt>+** simultaneously.
- Press the reset button on the system chassis.
- Press the power button to turn the system off then back on.



Using the **power button**, **reset button**, or the **<Ctrl>+<Alt>+** keys to force reset from a running operating system can cause damage to your data or system. We recommend to always shut down the system properly from the operating system.

The Setup program is designed to make it as easy to use as possible. Being a menu-driven program, it lets you scroll through the various submenus and make your selections from the available options using the navigation keys.



- The default BIOS settings for this motherboard apply for most conditions to ensure optimum performance. If the system becomes unstable after changing any BIOS settings, load the default settings to ensure system compatibility and stability. Select the **Load Setup Defaults** item under the Exit Menu. See section 2.8 Exit Menu.
- The BIOS setup screens shown in this section are for reference purposes only, and may not exactly match what you see on your screen.
- Visit the ASUS website at www.asus.com to download the latest BIOS file for this motherboard.

2.2.1 BIOS menu screen

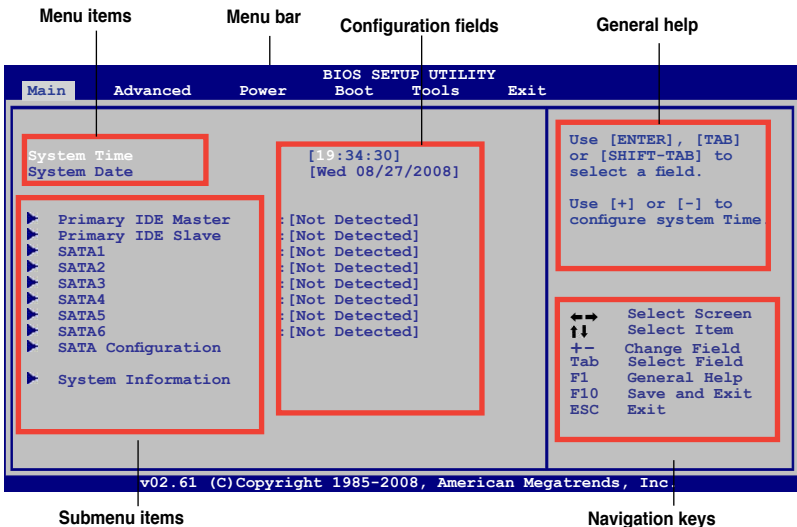

2.2.2 Menu bar

The menu bar on top of the screen has the following main items:

- | | |
|-----------------|---|
| Main | For changing the basic system configuration. |
| Advanced | For changing the advanced system settings. |
| Power | For changing the advanced power management (APM) configuration. |
| Boot | For changing the system boot configuration. |
| Tools | For changing the system tools configuration. |
| Exit | For selecting the exit options and loading default settings. |

To select an item on the menu bar, press the right or left arrow key on the keyboard until the desired item is highlighted.



- The BIOS setup screens shown in this chapter are for reference purposes only, and may not exactly match what you see on your screen.
- Visit the ASUS website at www.asus.com to download the latest BIOS information.

2.2.3 Navigation keys

At the bottom right corner of a menu screen are the navigation keys for that particular menu. Use the navigation keys to select items in the menu and change the settings.



Some of the navigation keys differ from one screen to another.

2.2.4 Menu items

The highlighted item on the menu bar displays the specific items for that menu. For example, selecting Main shows the Main menu items.

The other items (Advanced, Power, Boot, Tools, and Exit) on the menu bar have their respective menu items.

2.2.5 Submenu items

A solid triangle before each item on any menu screen means that the item has a submenu. To display the submenu, select the item and press **<Enter>**.

2.2.6 Configuration fields

These fields show the values for the menu items. If an item is user-configurable, you can change the value of the field opposite the item. You cannot select an item that is not user-configurable.

A configurable field is enclosed in brackets, and is highlighted when selected. To change the value of a field, select it then press **<Enter>** to display a list of options. Refer to “2.2.8 Pop-up window.”

2.2.7 General help

At the top right corner of the menu screen is a brief description of the selected item.

2.2.8 Pop-up window

Select a menu item then press **<Enter>** to display a pop-up window with the configuration options for that item.

2.2.9 Scroll bar

A scroll bar appears on the right side of a menu screen when there are items that do not fit on the screen. Press the **<Up>** / **<Down>** arrow keys or **<Page Up>** / **<Page Down>** keys to display the other items on the screen.

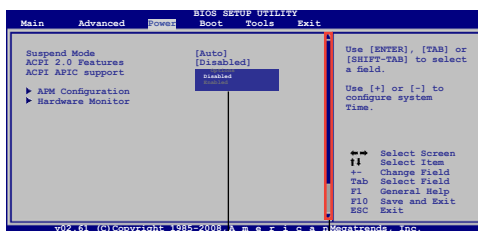

Pop-up window

Scroll bar

2.3 Main menu

When you enter the BIOS Setup program, the **Main** menu screen appears, giving you an overview of the basic system information.



Refer to section “2.2.1 BIOS menu screen” for information on the menu screen items and how to navigate through them.

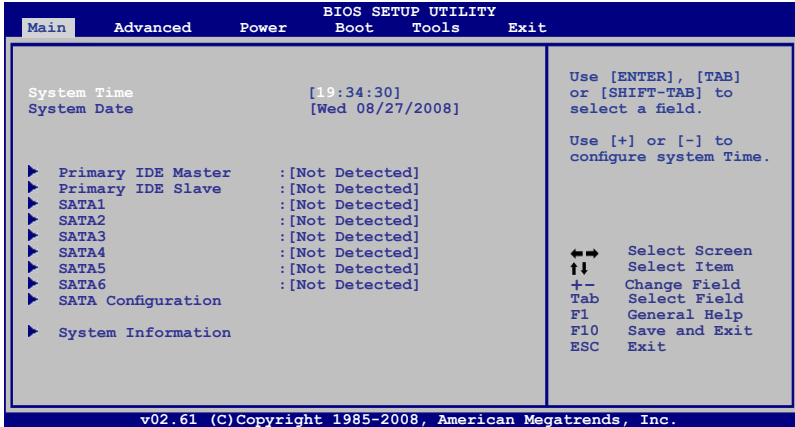

2.3.1 System Time [xx:xx:xx]

Allows you to set the system time.

2.3.2 System Date [Day xx/xx/xxxx]

Allows you to set the system date.

2.3.3 Primary IDE Master/Slave and SATA 1~6

While entering Setup, the BIOS automatically detects the presence of IDE/SATA devices. There is a separate submenu for each IDE/SATA device. Select a device item then press **<Enter>** to display the IDE/SATA device information.

The BIOS automatically detects the values opposite the dimmed items (Device, Vendor, Size, LBA Mode, Block Mode, PIO Mode, Async DMA, Ultra DMA, and SMART monitoring). These values are not user-configurable. These items show **Not Detected** if no IDE/SATA device is installed in the system.

Type [Auto]

Selects the type of IDE drive. Setting to **[Auto]** allows automatic selection of the appropriate IDE device type. Select **[CDROM]** if you are specifically configuring a CD-ROM drive. Select **[ARMD]** (ATAPI Removable Media Device) if your device is either a ZIP, LS-120, or MO drive. Configuration options: [Not Installed] [Auto] [CDROM] [ARMD]



This item does not appear when you select the **SATA 1/2/3/4/5/6** devices.

LBA/Large Mode [Auto]

Enables or disables the LBA mode. Setting to **[Auto]** enables the LBA mode if the device supports this mode, and if the device was not previously formatted with LBA mode disabled. Configuration options: [Disabled] [Auto]

Block (Multi-Sector Transfer) M [Auto]

Enables or disables data multi-sectors transfers. When set to **[Auto]**, the data transfer from and to the device occurs multiple sectors at a time if the device supports multi-sector transfer feature. When set to **[Disabled]**, the data transfer from and to the device occurs one sector at a time. Configuration options: [Disabled] [Auto]

PIO Mode [Auto]

Selects the PIO mode. Configuration options: [Auto] [0] [1] [2] [3] [4]

DMA Mode [Auto]

Selects the DMA mode. Configuration options: [Auto]

SMART Monitoring [Auto]

Sets the Smart Monitoring, Analysis, and Reporting Technology. Configuration options: [Auto] [Disabled] [Enabled]

32Bit Data Transfer [Enabled]

Enables or disables 32-bit data transfer. Configuration options: [Disabled] [Enabled]

2.3.4 SATA Configuration

This menu allows you to configure the SATA devices.

OnChip SATA Channel [Enabled]

Enables or disables the OnChip SATA Channel. Configuration options: [Enabled] [Disabled]

OnChip SATA Type [SATA]

Allows you to select the SATA type. Configuration options: [SATA] [RAID] [AHCI]

2.3.5 System Information

This menu gives you an overview of the general system specifications. The BIOS automatically detects the items in this menu.

BIOS Information

Displays the auto-detected BIOS information.

Processor

Displays the auto-detected CPU specification.

System Memory

Displays the auto-detected system memory.

2.4 Advanced menu

The **Advanced** menu items allow you to change the settings for the CPU and other system devices.



Be cautious when changing the settings of the Advanced menu items. Incorrect field values can cause the system to malfunction.

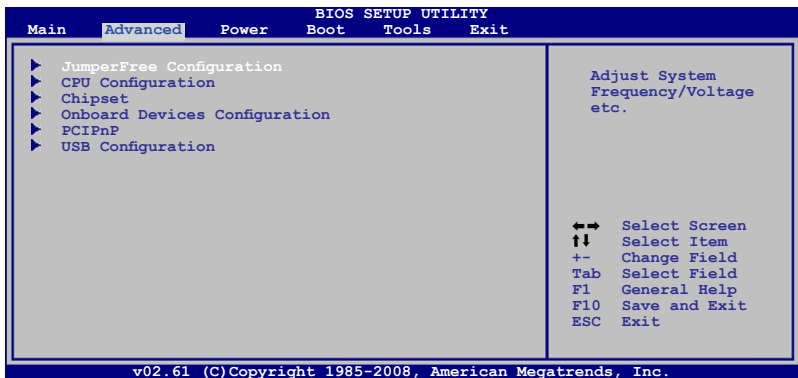

2.4.1 JumperFree Configuration

CPU Overclocking [Auto]

Allows selection of CPU overclocking options to achieve desired CPU internal frequency. Select any of the preset overclocking.

- **Manual** - Allows you to individually set the overclocking parameters.
- **Auto** - Loads the optimal settings for the system.
- **Overclock Profile** - Loads overclocking profiles with optimal parameters for stability when overclocking.
- **Test Mode** - Allows you to set the the overclocking parameter to 5%.



The following item appears only when you set the **AI Overclocking** item to **[Manual]**.

CPU /HT Reference Clock (MHz) [200]

Allows you to manually adjust CPU/HT reference clock. Key in a number between 200 to 550.



The following item appears only when you set the AI Overclocking item to **[Overclock Profile]**.

Overclock Options [Auto]

Allows you to select the overclock options. Configuration options: [Auto] [Overclock 2%] [Overclock 5%] [Overclock 8%] [Overclock 10%]

GPU Overclocking [Auto]

Allows you to select the GPU Overclocking. Configuration options: [Auto] [Manual]



The following item appears only when you set the GPU Overclocking item to **[Manual]**.

GPU Engine Clock [500]

Allows you to manually adjust GPU engine clock. Key in a number between 150 to 999.

PCIe Overclocking [Auto]

Allows you to select the PCIe Overclocking. Configuration options: [Auto] [Manual]



The following item appears only when you set the PCIe Overclocking item to **[Manual]**.

PCIe Clock [100]

Allows you to manually adjust PCIe clock. Key in a number between 100 to 150.

Processor Frequency Multiplier [Auto]

Allows you to set the processor frequency multiplier.

Configuration options: [Auto] [x4.0 800 MHz] [x5.0 1000 MHz] [x6.0 1200 MHz] [x7.0 1400 MHz] [x8.0 1600 MHz] [x9.0 1800 MHz]

Processor Voltage [Standard]

Allows you to set the processor voltage. Configuration options: [Power Saving Mode] [Standard] [+50mv] [+100mv]

HyperTransport Speed [Auto]

Allows you to set the HyperTransport link speed. Configuration options: [200 MHz] [400 MHz] [600 MHz] [800 MHz] [1 GHz] [Auto]

Hyper Transport Width [Auto]

Allows you to set the HyperTransport link width. Configuration options: [Auto] [4 Bit] [8 Bit] [16 Bit]

Memory Clock Mode [Auto]

Allows you to set the memory clock mode. Configuration options: [Auto] [Manual]



The following item appears only when you set the **Memory Clock Mode** item to **[Manual]**.

Memclock Value [266 MHz]

Allows you to select the memclock value. Configuration options: [200 MHz] [266 MHz] [333MHz] [400 MHz] [533 MHz]

DRAM Timing Mode [Auto]

Allows you to set the DRAM timing mode. Configuration options: [Auto] [DCT 0]



The following items appear only when the **DRAM Timing Mode** item is set to [DCT 0].

CAS# Latency [Auto]

Allows you to set CAS# latency. Configuration options: [Auto] [3 CLK] [4 CLK] [5 CLK] [6 CLK] [7 CLK DH_Only]

TRCD [Auto]

Allows you to set TRCD. Configuration options: [3 CLK] [4 CLK] [5 CLK] [6 CLK] [Auto]

TRP [Auto]

Allows you to set TRP. Configuration options: [3 CLK] [4 CLK] [5 CLK] [6 CLK] [Auto]

tRTP [Auto]

Allows you to specify the read CAS# to percharge time.

Configuration options: [Auto] [2-4 CLK] [3-5 CLK]

TRAS [Auto]

Allows you to set TRAS. Configuration options: [5 CLK] [6 CLK] [7 CLK] [8 CLK] [9 CLK] [10 CLK] [11 CLK] [12 CLK] [13 CLK] [14 CLK] [15 CLK] [16 CLK] [17 CLK] [18 CLK] [Auto]

TRC [Auto]

Allows you to set TRC. Configuration options: [11 CLK] [12 CLK] [13 CLK] [14 CLK] [15 CLK] [16 CLK] [17 CLK] [18 CLK] [19 CLK] [20 CLK] [21 CLK] [22CLK] [23 CLK] [24 CLK] [25 CLK] [26 CLK] [Auto]

tWR [Auto]

Allows you to specify when the last write is registered by the DRAM.

Configuration options: [Auto] [3 CLK] [4 CLK] [5 CLK] [6 CLK]

TRRD [Auto]

Allows you to set TRRD. Configuration options: [2 CLK] [3 CLK] [4 CLK] [5 CLK] [Auto]

tRWTO [Auto]

Allows you to set tRWTO. Configuration options: [Auto] [2 CLK] [3 CLK] [4 CLK] [5 CLK] [6 CLK] [7 CLK] [8 CLK] [9 CLK]

tWRRD [Auto]

Allows you to specify the write to read delay when accessing different DRAMs.

Configuration options: [Auto] [0 CLK] [1 CLK] [2 CLK] [3 CLK]

tWTR [Auto]

Allows you to specify the write to read delay when accessing the same DRAM.

Configuration options: [1 CLK] [2 CLK] [3 CLK] [Auto]

tWRWR [Auto]

Allows you to specify the Twrwr time. Configuration options: [Auto] [0 CLK] [1 CLK] [2 CLK] [3 CLK]

tRDRD [Auto]

Allows you to specify the Trdrd time. Configuration options: [Auto] [2 CLK] [3 CLK] [4 CLK] [5 CLK]

tRfC0/1/2/3 [Auto]

Allows you to specify the Trfc0/1/2/3 time. Configuration options: [Auto] [75ns] [105ns] [127.5ns] [195ns] [327.5ns]

Memory Over Voltage [Auto]

Allows you to set the Memory Over Voltage. Use +/- to adjust the voltage. The increment is 0.00625V. The standard value is 1.85000V. Configuration options: [Auto] [Min = 1.850000V] [Max = 2.24375V]

Chipset Voltage [Auto]

Allows you to set the Chipset Voltage.
Configuration options: [Auto][+ 50mv] [+ 100mv] [+ 150mv]

2.4.2 CPU Configuration

GART Error Reporting [Disabled]

This option should remain disabled for the normal operation. The driver developer may enable it for testing purpose. Configuration options: [Disabled] [Enabled]

Microcode Update [Enabled]

Allows you to enable or disable the microcode update.
Configuration options: [Disabled] [Enabled]

Secure Virtual Machine Mode [Enabled]

Allows you to enable or disable the AMD Secure Virtual Machine mode.
Configuration options: [Disabled] [Enabled]

Cool 'n' Quiet [Enabled]

Allows you to enable or disable the generation of ACPI_PPC, _PSS, and _PCT objects.
Configuration options: [Disabled] [Enabled]

CPU Prefetching [Enabled]

Allows you to enable or disable the CPU prefetching. Configuration options: [Enabled][Disabled]

2.4.3 Chipset

The **Chipset** menu allows you to change the advanced chipset settings. Select an item then press **<Enter>** to display the submenu.

NorthBridge Configuration

Memory Configuration

Bank Interleaving [Auto]

Allows you to enable the bank memory interleaving.
Configuration options: [Disabled] [Auto]

Channel Interleaving [Disabled]

Allows you to enable the channel memory interleaving.
Configuration options: [Disabled] [Address bits 6] [Address bits 12] [XOR of Address bits [20:16,6]] [XOR of Address bits [20:16,9]]

Enable Clock to All DIMMs [Disabled]

Enables or disables unused clocks to DIMMs even memory slots are not populated.

MemClk Tristate C3/ALTVID [Disabled]

Enables or disables the MemClk Tristate C3/ALTVID.

Configuration options: [Disabled] [Enabled]

Memory Hole Remapping [Enabled]

Allows you to enable or disable memory remapping around memory hole.

Configuration options: [Disabled] [Enabled]

DCT Unganged Mode [Auto]

DCT Unganged Mode [Auto]

Allows you to select unganged DRAM mode (64-bit width).

Configuration options: [Auto] [Always]

Power Down Enable [Enabled]

Allows you to enable or disable DDR power down mode.

Configuration options: [Disabled] [Enabled]

ECC Configuration

ECC Mode [Disabled]

Enables or disables the DRAM ECC that allows the hardware to report and correct memory errors automatically. Configuration options: [Disabled] [Basic] [Good] [Super] [Max] [User]

Internal Graphics

Primary Video Controller [GFX0-GPP-IGFX-PCI]

Configuration options: [GFX0-GPP-IGFX-PCI] [GPP-GFX0-IGFX-PCI]

[PCI-GFX0-GPP-IGFX] [IGFX-GFX0-GPP-PCI]



GFX0: VGA out port on a graphics card connected into a PCIE x16 slot
GPP: VGA out port on a graphics card connected into a PCIE x1 slot
IGFX: Internal VGA out port
PCI: VGA out port on a graphics card connected into a PCI slot

UMA Frame Buffer Size [Auto]

Configuration options: [Auto] [32MB] [64MB] [128MB] [256MB]

Surround View [Auto]

Allows you to disable or enable the Surround View function.

Configuration options: [Auto] [Disabled] [Enabled]



This item becomes user-configurable when you install an ATI graphics card into the PCI Express x16 slot.

2.4.4 Onboard Devices Configuration

Serial Port1 Address [3F8/IRQ4]

Allows you to select the Serial Port1 base address.

Configuration options: [Disabled] [3F8/IRQ4][2F8/IRQ3] [3E8/IRQ4] [2E8/IRQ3]

Parallel Port Address [378]

Allows you to select the Parallel Port base addresses.

Configuration options: [Disabled] [378] [278] [3BC]

Parallel Port Mode [Normal]

Allows you to select the Parallel Port mode. Configuration options: [Normal] [EPP] [ECP] [EPP+ECP]

Parallel Port IRQ [IRQ7]

Configuration options: [IRQ5] [IRQ7]

HDAudio Controller [Enabled]

Allows you to enable or disable the HD Audio Controller.

Configuration options: [Disabled] [Enabled]

Front Panel Select [HD Audio]

Allows you to set the HD audio mode. Configuration options: [AC97] [HD Audio]

Onboard LAN Controller [Enabled]

Allows you to enable or disable the Onboard LAN. Configuration options: [Enabled] [Disabled]

Onboard LAN Boot ROM [Disabled]

Allows you to enable or disable the Onboard LAN Boot ROM. Configuration options: [Enabled] [Disabled]

2.4.5 PCI PnP

The **PCI PnP** menu items allow you to change the advanced settings for PCI/PnP devices. The menu includes setting IRQ and DMA channel resources for either PCI/PnP or legacy ISA devices, and setting the memory size block for legacy ISA devices.



Be cautious when changing the settings of the PCI PnP menu items. Incorrect field values can cause the system to malfunction.

Plug and Play O/S [No]

When set to **[No]**, BIOS configures all the devices in the system. When set to **[Yes]** and if you install a Plug and Play operating system, the operating system configures the Plug and Play devices not required for boot. Configuration options: [No] [Yes]

2.4.6 USB Configuration

The items in this menu allow you to change the USB-related features. Select an item then press **<Enter>** to display the configuration options.



The **Module Version** and **USB Devices Enabled** items show the auto-detected values. If no USB device is detected, the item shows **None**.

USB Functions [Enabled]

Allows you to enable or disable the USB Functions.

Configuration options: [Enabled] [Disabled]

USB 2.0 Controller [Enabled]

Allows you to enable or disable the USB 2.0 Controller.

Configuration options: [Enabled] [Disabled]

Legacy USB Support [Auto]

Allows you to enable or disable support for USB devices on legacy operating systems (OS). Setting to **Auto** allows the system to detect the presence of USB devices at startup. If detected, the USB controller legacy mode is enabled. If no USB device is detected, the legacy USB support is disabled. Configuration options: [Disabled] [Enabled] [Auto]

USB 2.0 Controller Mode [HiSpeed]

Allows you to configure the USB 2.0 controller in HiSpeed (480 Mbps) or Full Speed (12 Mbps). Configuration options: [FullSpeed] [HiSpeed]

2.5 Power menu

The **Power** menu items allow you to change the settings for the Advanced Configuration and Power Interface (ACPI) and the Advanced Power Management (APM). Select an item then press **<Enter>** to display the configuration options.

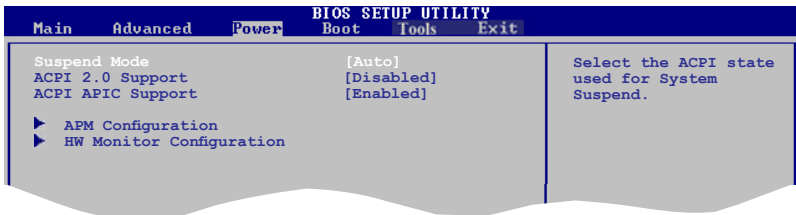

2.5.1 Suspend Mode [Auto]

Allows you to select the Advanced Configuration and Power Interface (ACPI) state to be used for system suspend. Configuration options: [S1 (POS) Only] [S3 Only] [Auto]

[S1(POS) Only] - Enables the system to enter the ACPI S1 (Power on Suspend) sleep state. In S1 sleep state, the system appears suspended and stays in a low power mode. The system can be resumed at any time.

[S3 Only] - Enables the system to enter the ACPI S3 (Suspend to RAM) sleep state (default). In S3 sleep state, the system appears to be off and consumes less power than in the S1 state. When signaled by a wake-up device or event, the system resumes to its working state exactly where it was left off.

[Auto] - Detected by OS.

2.5.2 ACPI 2.0 Support [Disabled]

Allows you to add more tables for Advanced Configuration and Power Interface (ACPI) 2.0 specifications. Configuration options: [Disabled] [Enabled]

2.5.3 ACPI APIC Support [Enabled]

Allows you to enable or disable the Advanced Configuration and Power Interface (ACPI) support in the Application-Specific Integrated Circuit (ASIC). When set to **Enabled**, the ACPI APIC table pointer is included in the RSDT pointer list. Configuration options: [Disabled] [Enabled]

2.5.4 APM Configuration

Restore on AC Power Loss [Always Off]

When set to **Power Off**, the system goes into off state after an AC power loss. When set to **Power On**, the system goes on after an AC power loss. Configuration options: [Power Off] [Power On] [Last State]

Power On From S5 By PME# [Disabled]

Allows you to enable or disable PME wake from sleep state. Configuration options: [Disabled] [Enabled]

Power On From S5 By Ring [Disabled]

Enable or disable RI to generate a wake event. Configuration options: [Disabled] [Enabled]

Power On From S5 By PS/2 KB/MS [Disabled]

Enable or disable PS/2 Keyboard/Mouse to generate a wake event. Configuration options: [Disabled] [Enabled]

Power On From S5 By RTC Alarm [Disabled]

Allows you to enable or disable RTC to generate a wake event. When this item is set to **Enabled**, the items RTC Alarm Date, RTC Alarm Hour, RTC Alarm Minute, and RTC Alarm Second appear with set values. Configuration options: [Disabled] [Enabled]

2.5.5 HW Monitor Configuration

CPU Temperature [xxx°C/xxx°F]

MB Temperature [xxx°C/xxx°F]

The onboard hardware monitor automatically detects and displays the motherboard and CPU temperatures. Select **Ignored** if you do not wish to display the detected temperatures.

CPU Fan Speed [xxxxRPM] or [Ignored]

The onboard hardware monitor automatically detects and displays the CPU and chassis speed in rotations per minute (RPM). If the fan is not connected to the motherboard, the field shows **N/A**. Select **Ignored** if you do not wish to display the detected speed.

Chassis Fan/Fan 2 Speed [N/A] or [Ignored]

The onboard hardware monitor automatically detects and displays the chassis fan speed in rotations per minute (RPM). If the fan is not connected to the chassis, the specific field shows **N/A**. Select **Ignored** if you do not wish to display the detected speed.

VCORE Voltage, 3.3V Voltage, 5V Voltage, 12V Voltage

The onboard hardware monitor automatically detects the voltage output through the onboard voltage regulators. Select **Ignored** if you do not wish to display the detected voltage output.

Smart Q-Fan Function [Enabled]

Allows you to enable or disable the ASUS Q-Fan feature that smartly adjusts the fan speeds for more efficient system operation. Configuration options: [Disabled] [Enabled]

Fan Auto Mode Start Voltage [5.0V]

Allows you to select the fan auto mode start voltage. Configuration options: [4.0V] [4.5V] [5.0V] [5.5V] [6.0V]

Fan Auto Mode Start Speed Temp [25°C]

Allows you to set the smart Q-Fan start working temperature. Configuration options: [25°C] [26°C] [27°C] ... [47°C] [48°C]

Fan Auto Mode Full Speed Temp [55°C]

Allows you to set the smart Q-Fan full speed temperature. Configuration options: [51°C] [52°C] [53°C] ... [74°C] [75°C]

2.6 Boot menu

The **Boot** menu items allow you to change the system boot options. Select an item then press **<Enter>** to display the submenu.

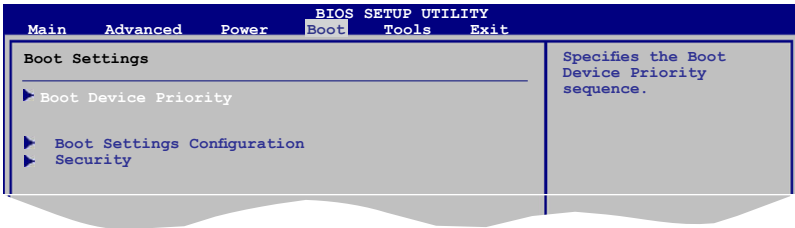

2.6.1 Boot Device Priority

1st ~ xxth Boot Device

These items specify the boot device priority sequence from the available devices. The number of device items that appears on the screen depends on the number of devices installed in the system. Configuration options: [Removable Dev.] [Hard Drive] [ATAPI CD-ROM] [Disabled]

2.6.2 Boot Settings Configuration

Quick Boot [Enabled]

Enabling this item allows the BIOS to skip some power on self tests (POST) while booting to decrease the time needed to boot the system. When set to **[Disabled]**, BIOS performs all the POST items. Configuration options: [Disabled] [Enabled]

Full Screen Logo [Enabled]

This allows you to enable or disable the full screen logo display feature. Configuration options: [Disabled] [Enabled]



Set this item to **[Enabled]** to use the ASUS MyLogo 2™ feature.

AddOn ROM Display Mode [Force BIOS]

Sets the display mode for option ROM. Configuration options: [Force BIOS] [Keep Current]

Bootup Num-Lock [On]

Allows you to select the power-on state for the NumLock. Configuration options: [Off] [On]

Wait for 'F1' If Error [Enabled]

When set to **Enabled**, the system waits for the F1 key to be pressed when error occurs.
Configuration options: [Disabled] [Enabled]

Hit 'DEL' Message Display [Enabled]

When set to **Enabled**, the system displays the message **Press DEL to run Setup** during POST. Configuration options: [Disabled] [Enabled]

2.6.3 Security

The Security menu items allow you to change the system security settings. Select an item then press **<Enter>** to display the configuration options.

Change Supervisor Password

Select this item to set or change the supervisor password. The Supervisor Password item on top of the screen shows the default **Not Installed**. After you set a password, this item shows **Installed**.

To set a Supervisor Password:

1. Select the **Change Supervisor Password** item and press **<Enter>**.
2. From the password box, type a password composed of at least six letters and/or numbers, then press **<Enter>**.
3. Confirm the password when prompted.

The message "Password Installed" appears after you successfully set your password.

To change the supervisor password, follow the same steps as in setting a supervisor password.

To clear the supervisor password, select the **Change Supervisor Password** then press **<Enter>**. The message "Password Uninstalled" appears.



If you forget your BIOS password, you can clear it by erasing the CMOS Real Time Clock (RTC) RAM. See section "1.9 Jumpers" for information on how to erase the RTC RAM.

After you have set a supervisor password, the other items appear to allow you to change other security settings.

User Access Level [Full Access]

This item allows you to select the access restriction to the Setup items. Configuration options: [No Access] [View Only] [Limited] [Full Access]

No Access prevents user access to the Setup utility.

View Only allows access but does not allow change to any field.

Limited allows changes only to selected fields, such as Date and Time.

Full Access allows viewing and changing all the fields in the Setup utility.

Change User Password

Select this item to set or change the user password. The User Password item on top of the screen shows the default **Not Installed**. After you set a password, this item shows **Installed**.

To set a User Password:

1. Select the **Change User Password** item and press **<Enter>**.
2. On the password box that appears, type a password composed of at least six letters and/or numbers, then press **<Enter>**.
3. Confirm the password when prompted.

The message "Password Installed" appears after you set your password successfully.

To change the user password, follow the same steps as in setting a user password.

Clear User Password

Select this item to clear the user password.

Password Check [Setup]

When set to **[Setup]**, BIOS checks for user password when accessing the Setup utility. When set to **[Always]**, BIOS checks for user password both when accessing Setup and booting the system. Configuration options: [Setup] [Always]

2.7 Tools menu

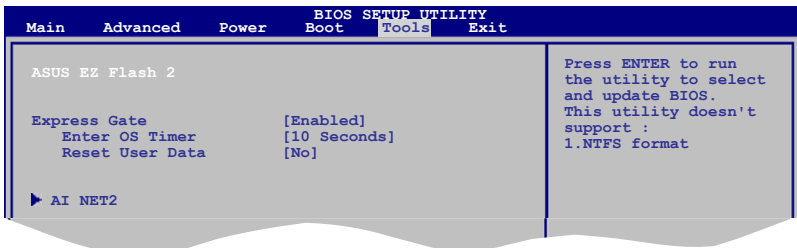

2.7.1 ASUS EZ Flash 2

Allows you to run ASUS EZ Flash 2. When you press **<OK>**, a confirmation message appears. Use the left/right arrow key to select between **[Yes]** or **[No]**, then press **<OK>** to confirm your choice.

2.7.2 Express Gate [Enabled]

Allows you to enable or disable the ASUS Express Gate feature. The ASUS Express Gate feature is a unique instant-on environment that provides quick access to the Internet browser and Skype. Configuration options: [Enabled] [Disabled] *Enter OS Timer [10 Seconds]*

Sets countdown duration that the system waits at the Express Gate's first screen before starting Windows or other installed OS. Choose [Prompt User] to stay at the first screen of Express Gate for user action.

Configuration options: [Prompt User] [1 second] [3 seconds] [5 seconds] [10 seconds] [15 seconds] [20 seconds] [30 seconds]

Reset User Data [No]

Allows you to clear Express Gate's user data.

Configuration options: [No] [Reset]

When setting this item to **[Reset]**, make sure to save the setting to the BIOS so that the user data will be cleared the next time you enter the Express Gate. User data includes the Express Gate's settings as well as any personal information stored by the web browser (bookmarks, cookies, browsing history, etc.). This is useful in the rare case where corrupt settings prevent the Express Gate environment from launching properly.



The first time wizard will run again when you enter the Express Gate environment after clearing its settings.

2.7.3 AI NET 2

Check Realtek Phy LAN cable [Disabled]

Enables or disables checking of the Realtek Phy LAN cable during the Power-On Self-Test (POST). Configuration options: [Disabled] [Enabled]

2.8 Exit menu

The Exit menu items allow you to load the optimal or failsafe default values for the BIOS items, and save or discard your changes to the BIOS items.

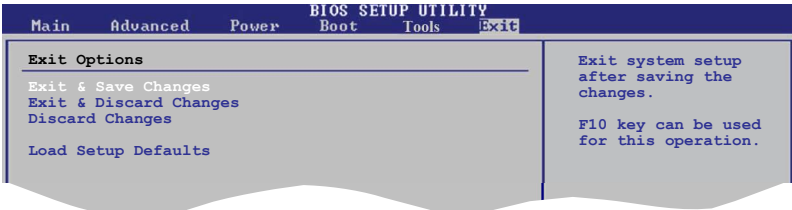

Pressing **<Esc>** does not immediately exit this menu. Select one of the options from this menu or **<F10>** from the legend bar to exit.

Exit & Save Changes

Once you are finished making your selections, choose this option from the Exit menu to ensure the values you selected are saved to the CMOS RAM. An onboard backup battery sustains the CMOS RAM so it stays on even when the PC is turned off. When you select this option, a confirmation window appears. Select **OK** to save changes and exit.



If you attempt to exit the Setup program without saving your changes, the program prompts you with a message asking if you want to save your changes before exiting. Press **<Enter>** to save the changes while exiting.

Exit & Discard Changes

Select this option only if you do not want to save the changes that you made to the Setup program. If you made changes to fields other than System Date, System Time, and Password, the BIOS asks for a confirmation before exiting.

Discard Changes

This option allows you to discard the selections you made and restore the previously saved values. After selecting this option, a confirmation appears. Select **OK** to discard any changes and load the previously saved values.

Load Setup Defaults

This option allows you to load the default values for each of the parameters on the Setup menu. When you select this option or if you press **<F5>**, a confirmation window appears. Select **OK** to load default values. Select **Exit & Save Changes** or make other changes before saving the values to the non-volatile RAM.

