

QE-E70

Qseven CPU Module

User's Manual

Edition 1.1
2015/07/15



Copyright

Copyright 2015, all rights reserved. This document is copyrighted and all rights are reserved. The information in this document is subject to change without prior notice to make improvements to the products.

This document contains proprietary information and protected by copyright. No part of this document may be reproduced, copied, or translated in any form or any means without prior written permission of the manufacturer.

All trademarks and/or registered trademarks contains in this document are property of their respective owners.

Disclaimer

The company shall not be liable for any incidental or consequential damages resulting from the performance or use of this product.

The company does not issue a warranty of any kind, express or implied, including without limitation implied warranties of merchantability or fitness for a particular purpose.

The company has the right to revise the manual or include changes in the specifications of the product described within it at any time without notice and without obligation to notify any person of such revision or changes.

Trademark

All trademarks are the property of their respective holders.

Any questions please visit our website at <http://www.comnell.com.tw>

Packing List:

Please check the package content before you starting using the board.

Hardware:

QE-E70 Qseven CPU Module x 1

Cable Kit:



**CRT cable without bracket x 1
(OALVGA-DF14NB) (1040596)**

Printed Matters:

C Power Cable x 1
ALDC-A / (1040433)

Driver CD (Including User's Manual) x 1

Cooler:



(OHSF-7) / (2181010020)
QE-E70J, QE-E70E

Heat Sink:



(OHS-9) / (2181110011)
QE-E70N

Index

Chapter 1 <Introduction>	5
1.1 <Product Overview>	5
1.2 <Product Specification>	6
1.3 <Mechanical Drawing>	8
1.4 <Block Diagram>	9
Chapter 2 <Hardware Setup>	10
2.1 <Connector Location>	10
2.2 <Interface Reference>	11
2.2.1 <Internal interface>	11
2.3 < Connector Pin Assignments>	11
2.3.1 <PCI Express Interface Signals>	14
2.3.2<Serial ATA Interface Signals>	15
2.3.3<Serial ATA Interface Signals>	15
2.3.4<SDIO Interface Signals>	16

2.3.5<High Definition Audio Signals/AC'97>	16
2.3.6<LVDS Flat Panel Signals>.....	17
2.3.7<DisplayPort Interface Signals>.....	18
2.3.7<HDMI Interface Signals>.....	18
2.3.8<LPC Interface Signals>	19
2.3.9<SPI Interface Signals>	19
2.3.10<Input Power Pins>	20
2.3.11<Power Control Signals>	20
2.3.12<Power Management Signals>.....	20
2.3.13<Miscellaneous Signals>	21
2.3.14<Thermal Management Signals>.....	21
2.4 < VGA Interface >.....	22
Chapter 3 <System Setup>	23
3.1 <Audio Configuration>.....	23
3.2 <Display Properties Setting>.....	23
3.3 <SATA configuration>.....	25
3.4 <USB3.0 configuration>	26
3.4.1 < USB 3.0 eXtensible Host Controller Driver install >	26
Chapter 4 <BIOS Setup>	27
Appendix A <Flash BIOS>.....	29
A.1 <Flash Tool>	29
A.2 <Flash BIOS Procedure>.....	29
Appendix B <Programming GPIO's>	30
Appendix C <Programming Watchdog Timer >	31
Contact Information.....	32

Chapter 1 <Introduction>

1.1 <Product Overview>

QE-E70 is the system-on-chip (SoC) designed for intelligent systems, delivering outstanding compute, graphical, and media performance while operating in an extended range of thermal conditions. These SoCs are based on the Silvermont microarchitecture, utilizing Intel's industry-leading 22nm process technology with 3-D Tri-Gate transistors, which deliver significant improvements in computational performance and energy efficiency.

New features for Intel® Celeron® and Atom Processor

The Intel® Celeron® Processor J1900 / N2930 and Intel® Atom E3845 Processor supports, graphics, media performance, flexibility and more enhanced security that is suitable for a variety of intelligent systems the ideal choice.

Outstanding integration of I/O interfaces

Supports display interfaces with graphics processing, camera interfaces with image processing, audio with digital signal processing, multiple storage types, and legacy embedded I/O. Provides interface expansion capabilities through industry-standard high-bandwidth interfaces such as PCI Express* Gen 2.0, Hi-speed USB 2.0, and USB 3.0 connectivity.

All in One multimedia solution

Based on Intel® J1900 / N2920 / E3845 SoC, the board provides high performance onboard graphics, CRT, 24-bit dual channel LVDS interface, Display Port, DVI and two channels High Definition Audio, to meet the very requirement of the multimedia application.

Flexible Extension Interface

The board provides four PCIe2.0x1,LPC for super I/O,SDIO and SPI for system BIOS.

1.2 <Product Specification>

General Specification

Form Factor	Qseven CPU Module
CPU	Bay Trail Intel® Celeron™ J1900 / N2930 and Atom™ E3845 Mobile Processor Package Type: FCBGA1170
Memory	Support DDR3L 1600 MHz 2GB or 4GB on board memory
Watchdog Timer	Generates a system reset with internal timer for 1min/s ~ 255min/s
Graphic	Intel® Clear Video integrated HD Graphics Technology
DDI	Two DDI port interface for DisplayPort, DVI or eDP
Extended Interface	Four PCIe2.0 x1 LPC for super I/O SMBus SPI for System BIOS
External I/O Interface	Two SATAII(3Gb/s) Four USB 2.0 & one USB 3.0 High definition audio interface
Internal I/O Interface	CRT interface
Power Requirement	5V and 5V standby
Dimension	70mm x 70mm(L x W)
Temperature	Operating within 0~60 °C.(for QE-E70N and QE-E70J) Storage within -20~85 °C centigrade. (for QE-E70N and QE-E70J) Operating within -40~85 °C.(for QE-E70E) Storage within -40~85 °C centigrade. (for QE-E70E)

Ordering Code

QE-E70JED-2GB(4GB)	Intel Celeron Processor J1900 (2M Cache, 2.42GHz), eDP, DP, VGA, HD Audio interface, two Serial ATAll, one USB3.0 , four USB 2.0, four PCIe x1, 2G(4G) Memory
QE-E70EED-2GB(4GB)	Intel Atom Processor E3845 (2M Cache, 1.91GHz), eDP, DP, VGA, HD Audio interface, two Serial ATAll, one USB3.0 , four USB 2.0, four PCIe x1, 2G(4G) Memory
QE-E70NED-2GB(4GB)	Intel Celeron Processor N2930 (2M Cache, 2.16GHz), eDP, DP, VGA, HD Audio interface, two Serial ATAll, one USB3.0 , four USB 2.0, four PCIe x1, 2G(4G) Memory
QE-E70JE2-2GB(4GB)	Intel Celeron Processor J1900 (2M Cache, 2.42GHz), two eDP, VGA, HD

LN-D70 User's Manual

Audio interface, two Serial ATAll, one USB3.0 , four USB 2.0, four PCIe x1,
2G(4G) Memory

QE-E70EE2-2GB(4GB) Intel Atom Processor E3845 (2M Cache, 1.91GHz), two eDP, VGA, HD Audio interface, two Serial ATAll, one USB3.0 , four USB 2.0, four PCIe x1, 2G(4G) Memory

QE-E70NE2-2GB(4GB) Intel Celeron Processor N2930 (2M Cache, 2.16GHz), two eDP, VGA, HD Audio interface, two Serial ATAll, one USB3.0 , four USB 2.0, four PCIe x1, 2G(4G) Memory

The specifications may be different as the actual production.

For further product information please visit the website at <http://www.commell.com.tw>

1.4 <Block Diagram>

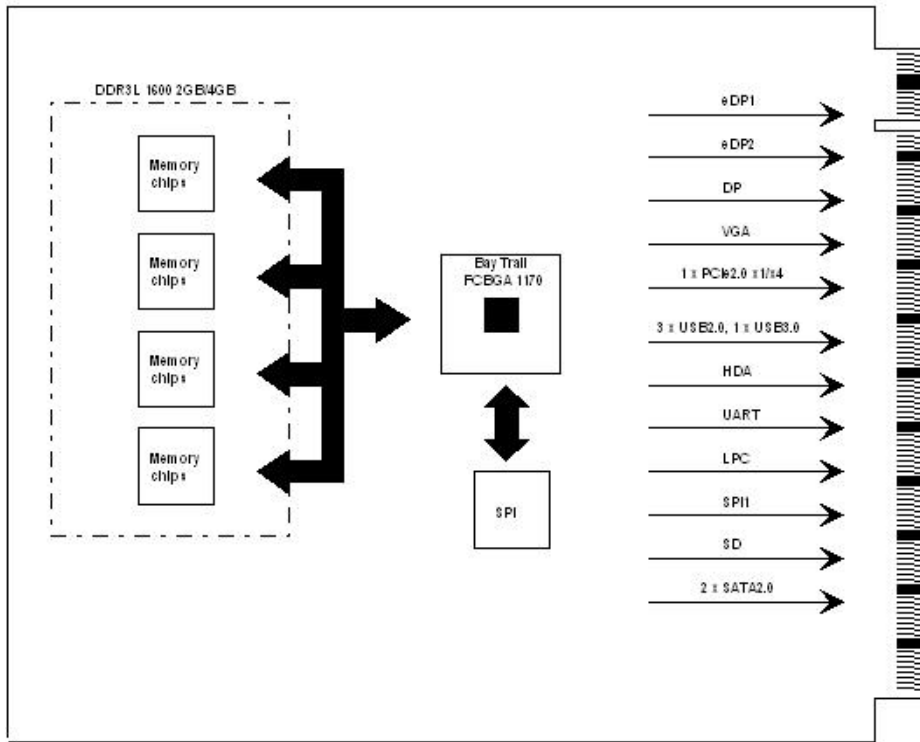

Chapter 2 <Hardware Setup>

2.1 <Connector Location>

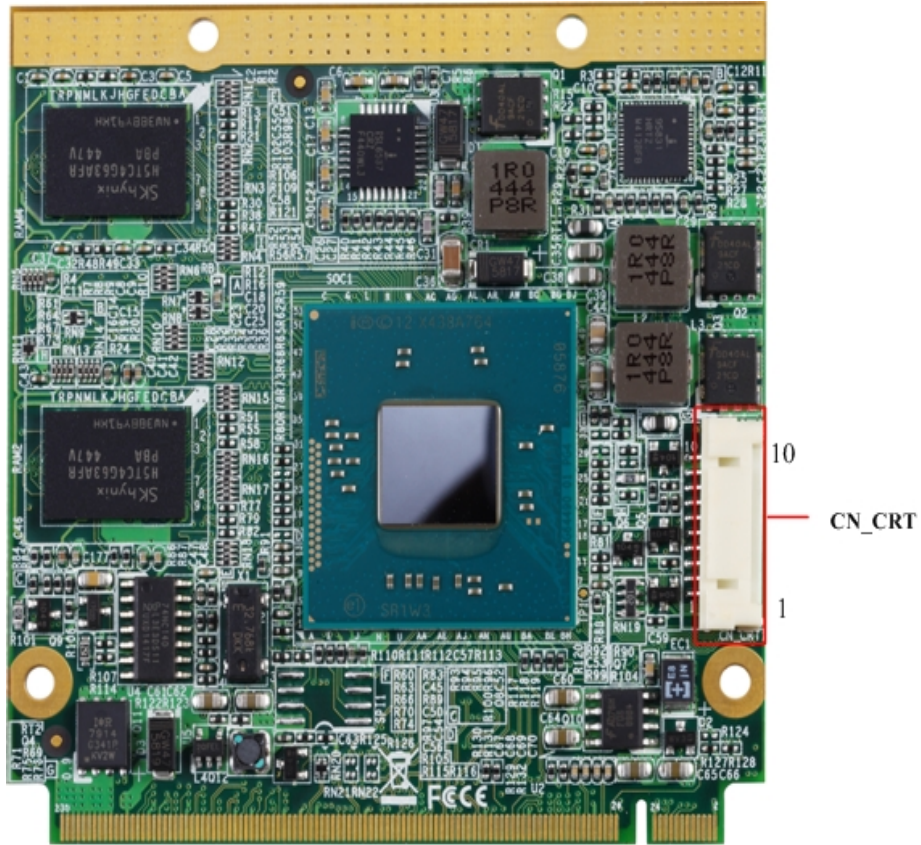

2.2 <Interface Reference>

2.2.1 <Internal interface>

Interface	Function	Remark
CPU	FCBGA1170 CPU	
CN_CRT	10-pin VGA connector	

2.2.2 <External Interface>

interface	Function	Remark
PCIe2.0	Four PCIe2.0 x1	
LPC	LPC for super I/O	
SDIO	SDIO for super I/O	
SPI	SPI for System BIOS	
SATAII	Two SATAII(3Gb/s),	
USB	Four USB 2.0 & one USB 3.0,	
Audio	High definition audio interface	

2.3 < Connector Pin Assignments>

There are 115 edge fingers on the top and bottom side of the QsevenR module that mate with the MXM connector. Table 2.3 lists the pin assignments for all 230 edge fingers.

Table 2.3 Connector Pinout Description

Pin	Signal	Pin	Signal
1	GND	2	GND
3	GBE_MDI3-	4	GBE_MDI2-
5	GBE_MDI3+	6	GBE_MDI2+
7	GBE_LINK100#	8	GBE_LINK1000#
9	GBE_MDI1-	10	GBE_MDI0-
11	GBE_MDI1+	12	GBE_MDI0+
13	GBE_LINK#	14	GBE_ACT#
15	GBE_CTREF	16	SUS_S5#
17	WAKE#	18	SUS_S3#
19	SUS_STAT#	20	PWRBTN#
21	SLP_BTN#	22	LID_BTN#
23	GND	24	GND
	KEY		KEY
25	GND	26	PWGIN

LN-D70 User's Manual

27	BATLOW#	28	RSTBTN#
29	SATA0_TX+	30	SATA1_TX+
31	SATA0_TX-	32	SATA1_TX-
33	SATA_ACT#	34	GND
35	SATA0_RX+	36	SATA1_RX+
37	SATA0_RX-	38	SATA1_RX-
39	GND	40	GND
41	BIOS_DISABLE# / BOOT_ALT#	42	SDIO_CLK#
43	SDIO_CD#	44	SDIO_LED
45	SDIO_CMD	46	SDIO_WP
47	SDIO_PWR#	48	SDIO_DAT1
49	SDIO_DAT0	50	SDIO_DAT3
51	SDIO_DAT2	52	SDIO_DAT5
53	SDIO_DAT4	54	SDIO_DAT7
55	SDIO_DAT6	56	RSVD
57	GND	58	GND
59	HDA_SYNC/ I2S_WS	60	SMB_CLK/ GP1_I2C_CLK
61	HDA_RST#/ I2S_RST#	62	SMB_DAT/ GP1_I2C_DAT
63	HDA_BITCLK/ I2S_CLK	64	SMB_ALERT#
65	HDA_SDI/ I2S_SDI	66	GP0_I2C_CLK
67	HDA_SDO/ I2S_SDO	68	GP0_I2C_DAT
69	THRM#	70	WDTRIG#
71	THRMTRIP#	72	WDOUT
73	GND	74	GND
75	USB_P7-/ USB_SSTX0-	76	USB_P6-/ USB_SSRX0-
77	USB_P7+/ USB_SSTX0+	78	USB_P6+/ USB_SSRX0+
79	USB_6_7_OC#	80	USB_4_5_OC#
81	USB_P5-/ USB_SSTX1-	82	USB_P4-/ USB_SSRX1-
83	USB_P5+/ USB_SSTX1+	84	USB_P4+/ USB_SSRX1+
85	USB_2_3_OC#	86	USB_0_1_OC#
87	USB_P3-	88	USB_P2-
89	USB_P3+	90	USB_P2+
91	USB_CC	92	USB_ID
93	USB_P1-	94	USB_P0-
95	USB_P1+	96	USB_P0+
97	GND	98	GND
99	eDP0_TX0+/ LVDS_A0+	100	eDP1_TX0+/ LVDS_B0+
101	eDP0_TX0-/ LVDS_A0-	102	eDP1_TX0-/ LVDS_B0-
103	eDP0_TX1+/ LVDS_A1+	104	eDP1_TX1+/ LVDS_B1+
105	eDP0_TX1-/ LVDS_A1-	106	eDP1_TX1-/ LVDS_B1-
107	eDP0_TX2+/ LVDS_A2+	108	eDP1_TX2+/ LVDS_B2+
109	eDP0_TX2-/ LVDS_A2-	110	eDP1_TX2-/ LVDS_B2-

LN-D70 User's Manual

111	LVDS_PPEN	112	LVDS_BLEN
113	eDP0_TX3+/ LVDS_A3+	114	eDP1_TX3+/ LVDS_B3+
115	eDP0_TX3-/ LVDS_A3-	116	eDP1_TX3-/ LVDS_B3-
117	GND	118	GND
119	eDP0_AUX+/ LVDS_A_CLK+	120	eDP1_AUX+/ LVDS_B_CLK+
121	eDP0_AUX-/ LVDS_A_CLK-	122	eDP1_AUX-/ LVDS_B_CLK-
123	LVDS_BLT_CTRL /GP_PWM_OUT0	124	GP_1-Wire_Bus
125	GP2_I2C_DAT/ LVDS_DID_DAT	126	eDP0_HPD# / LVDS_BLC_DAT
127	GP2_I2C_CLK / LVDS_DID_CLK	128	eDP1_HPD# / LVDS_BLC_CLK
129	CAN0_TX	130	CAN0_RX
131	DP_LANE3+/ TMDS_CLK+	132	RSVD (Differential Pair)
133	DP_LANE3-/ TMDS_CLK-	134	RSVD (Differential Pair)
135	GND	136	GND
137	DP_LANE1+/ TMDS_LANE1+	138	DP_AUX+
139	DP_LANE1-/ TMDS_LANE1-	140	DP_AUX-
141	GND	142	GND
143	DP_LANE2+ / TMDS_LANE0+	144	RSVD (Differential Pair)
145	DP_LANE2- / TMDS_LANE0-	146	RSVD (Differential Pair)
147	GND	148	GND
149	DP_LANE0+ / TMDS_LANE2+	150	HDMI_CTRL_DAT
151	DP_LANE0- / TMDS_LANE2-	152	HDMI_CTRL_CLK
153	DP_HDMI_HPD#	154	RSVD
155	PCIE_CLK_REF+PCIE_CLK_REF+	156	PCIE_WAKE#
157	PCIE_CLK_REF-	158	PCIE_RST#
159	GND	160	GND
161	PCIE3_TX+	162	PCIE3_RX+
163	PCIE3_TX-	164	PCIE3_RX-
165	GND	166	GND
167	PCIE2_TX+	168	PCIE2_RX+
169	PCIE2_TX-	170	PCIE2_RX-
171	UART0_TX	172	UART0_RTS#
173	PCIE1_TX+	174	PCIE1_RX+
175	PCIE1_TX-	176	PCIE1_RX-
177	UART0_RX	178	UART0_CTS#
179	PCIE0_TX+	180	PCIE0_RX+
181	PCIE0_TX-	182	PCIE0_RX-
183	GND	184	GND
185	LPC_AD0 / GPIO0	186	LPC_AD1 / GPIO1
187	LPC_AD2 / GPIO2	188	LPC_AD3 / GPIO3
189	LPC_CLK / GPIO4	190	LPC_FRAME# / GPIO5

LN-D70 User's Manual

191	SERIRQ / GPIO6	192	LPC_LDRQ# / GPIO7
193	VCC_RTC	194	SPKR / GP_PWM_OUT2
195	FAN_TACHOIN / GP_TIMER_IN	196	FAN_PWMOUT / GP_PWM_OUT1
197	GND	198	GND
199	SPI_MOSI	200	SPI_CS0#
201	SPI_MISO	202	SPI_CS1#
203	SPI_SCK	204	MFG_NC4
205	VCC_5V_SB	206	VCC_5V_SB
207	MFG_NC0	208	MFG_NC2
209	MFG_NC1	210	MFG_NC3
211	VCC	212	VCC
213	VCC	214	VCC
215	VCC	216	VCC
217	VCC	218	VCC
219	VCC	220	VCC
221	VCC	222	VCC
223	VCC	224	VCC
225	VCC	226	VCC
227	VCC	228	VCC
229	VCC	230	VCC

2.3.1 <PCI Express Interface Signals>

Signal	Description
PCIE0_RX+	PCI Express channel 0, Receive Input differential pair.
PCIE0_RX-	
PCIE0_TX+	PCI Express channel 0, Transmit Output differential pair.
PCIE0_TX-	
PCIE1_RX+	PCI Express channel 1, Receive Input differential pair.
PCIE1_RX-	
PCIE1_TX+	PCI Express channel 1, Transmit Output differential pair.
PCIE1_TX-	
PCIE2_RX+	PCI Express channel 2, Receive Input differential pair.
PCIE2_RX-	
PCIE2_TX+	PCI Express channel 2, Transmit Output differential pair.
PCIE2_TX-	
PCIE3_RX+	PCI Express channel 3, Receive Input differential pair.
PCIE3_RX-	
PCIE3_TX+	PCI Express channel 3, Transmit Output differential pair.
PCIE3_TX-	

PCIE3_TX-

PCIE_CLK_REF+ PCI Express Reference Clock for Lanes 0 to 3.

PCIE_CLK_REF-

PCIE_WAKE# PCI Express Wake Event: Sideband wake signal asserted by components requesting wakeup.

PCIE_RST# Reset Signal for external devices.

2.3.2<Serial ATA Interface Signals>

Signal	Description
SATA0_RX+	Serial ATA channel 0, Receive Input differential pair.
SATA0_RX-	
SATA0_TX+	Serial ATA channel 0, Transmit Output differential pair.
SATA0_TX-	
SATA0_RX+	Serial ATA channel 1, Receive Input differential pair.
SATA0_RX-	
SATA0_TX+	Serial ATA channel 1, Transmit Output differential pair.
SATA0_TX-	
SATA_ACT#	Serial ATA Led. Open collector output pin driven during SATA command activity.

2.3.3<Serial ATA Interface Signals>

Signal	Description
USB_P0+	Universal Serial Bus Port 0 differential pair.
USB_P0-	
USB_P1+	Universal Serial Bus Port 1 differential pair.
USB_P1-	This port may be optionally used as USB client port.
USB_P2+	Universal Serial Bus Port 2 differential pair.
USB_P2-	
USB_P3+	Universal Serial Bus Port 3 differential pair.
USB_P3-	
USB_SSRX0+	Multiplexed with receive signal differential pairs for the Superspeed USB data path.
USB_SSRX0-	

USB_SSTX0+	Multiplexed with transmit signal differential pairs for the
USB_SSTX0-	Superspeed USB data path.
USB_0_1_OC#	Over current detect input 1. This pin is used to monitor the USB power over current of the USB Ports 0 and 1.
USB_2_3_OC#	Over current detect input 2. This pin is used to monitor the USB power over current of the USB Ports 2 and 3.

2.3.4<SDIO Interface Signals>

Signal	Description
SDIO_CD#	SDIO Card Detect. This signal indicates when a SDIO card is present.
SDIO_CLK	SDIO Clock. With each cycle of this signal a one-bit transfer on the command and each data line occurs. This signal has maximum frequency of 48 MHz.
SDIO_CMD	SDIO Command/Response. This signal is used for card initialization and for command transfers. During initialization mode this signal is open drain. During command transfer this signal is in push-pull mode.
SDIO_WP	SDIO Write Protect. This signal denotes the state of the write-protect tab on SD cards.
SDIO_PWR#	SDIO Power Enable. This signal is used to enable the power being supplied to a SD card device.
SDIO_DAT0-3	SDIO Data lines. These signals operate in push-pull mode.

2.3.5<High Definition Audio Signals/AC'97>

Signal	Description
HDA_RST#	HD Audio/AC'97 Codec Reset.
HDA_SYNC	Serial Bus Synchronization.
HDA_BCLK	HD Audio/AC'97 24 MHz Serial Bit Clock from Codec.
HDA_SDO	HD Audio/AC'97 Serial Data Output to Codec.
HDA_SDI	HD Audio/AC'97 Serial Data Input from Codec.

2.3.6<LVDS Flat Panel Signals>

Signal	Description
LVDS_PPEN	Controls panel power enable.
LVDS_BLEN	Controls panel backlight enable.
LVDS_BLT_CTRL	Primary functionality is to control the panel backlight brightness via pulse width modulation (PWM).
eDP0_TX0+ eDP0_TX0-	Display Port primary channel differential pair 0.
eDP0_TX1+ eDP0_TX1-	Display Port primary channel differential pair 1.
eDP0_TX2+ eDP0_TX2-	Display Port primary channel differential pair 2.
eDP0_TX3+ eDP0_TX3-	Display Port primary channel differential pair 3.
eDP0_AUX+ eDP0_AUX-	Display Port primary auxiliary channel.
eDP1_TX0+ eDP1_TX0-	Display Port secondary channel differential pair 0.
eDP1_TX1+ eDP1_TX1-	Display Port secondary channel differential pair 1.
eDP1_AUX+ eDP1_AUX-	Display Port secondary auxiliary channel.
eDP0_HPD#	If the primary functionality is not used, it can be used as an emedded DisplayPort primary Hotplug detection.
eDP1_HPD#	If the primary functionality is not used, it can be used as an emedded DisplayPort secondary Hotplug detection.

2.3.7<DisplayPort Interface Signals>

Signal	Shared With	Description
DP_LANE3- DP_LANE3+	TMDS_CLK- TMDS_CLK+	DisplayPort differential pair lines lane 3.
DP_LANE2- DP_LANE2+	TMDS_LANE0- TMDS_LANE0+	DisplayPort differential pair lines lane 2.
DP_LANE1- DP_LANE1+	TMDS_LANE1- TMDS_LANE1+	DisplayPort differential pair lines lane 1.
DP_LANE0- DP_LANE0+	TMDS_LANE2- TMDS_LANE2+	DisplayPort differential pair lines lane 0.
DP_AUX		Auxiliary channel used for link management and device control. Differential pair lines.
DPHDMI_HPD#		Hot plug detection signal that serves as an interrupt request.

2.3.7<HDMI Interface Signals>

Signal	Shared With	Description
TMDS_CLK- TMDS_CLK+	DP_LANE3- DP_LANE3+	TMDS differential pair clock lines.
TMDS_LANE0- TMDS_LANE0+	DP_LANE2- DP_LANE2+	TMDS differential pair lines lane 0.
TMDS_LANE1- TMDS_LANE1+	DP_LANE1- DP_LANE1+	TMDS differential pair lines lane 1.
TMDS_LANE2- TMDS_LANE2+	DP_LANE0- DP_LANE0+	TMDS differential pair lines lane 2.
HDMI_CTRL_CLK		DDC based control signal (clock) for HDMI device.

		Note: Level shifters must be implemented on the carrier board for this signal in order to be compliant with the HDMI Specification.
HDMI_CTRL_DAT		DDC based control signal (data) for HDMI device. Note: Level shifters must be implemented on the carrier board for this signal in order to be compliant with the HDMI Specification.
DP_HDMI_HPD#		Hot plug detection signal that serves as an interrupt request.

2.3.8<LPC Interface Signals>

Signal	Description
HLPC Interface	Multiplexed Command, Address and Data.
Signals	
LPC_FRAME#	LPC frame indicates the start of a new cycle or the termination of a broken cycle.
LPC_CLK	LPC clock.
SERIRQ	Serialized Interrupt.

2.3.9<SPI Interface Signals>

Signal	Description
SPI_MOSI	Master serial output/Slave serial input signal. SPI serial output data from QsevenR module to the SPI device.
SPI_MISO	Master serial input/Slave serial output signal. SPI serial input data from the SPI device to QsevenR module.
SPI_SCK	SPI clock output.
SPI_CS0#	SPI chip select 0 output.
SPI_CS1#	SPI Chip Select 1 signal is used as the second chip select when two devices are used. Do not use when only one SPI device is used.

2.3.10<Input Power Pins>

Signal	Description
VCC	Power Supply +5VDC \pm 5%.
VCC_5V_SB	Standby Power Supply +5VDC \pm 5%.
VCC_RTC	3 V backup cell input. VCC_RTC should be connected to a 3V backup cell for RTC operation and storage register non-volatility in the absence of system power. (VCC_RTC = 2.4 - 3.3 V).
GND	Power Ground.

2.3.11<Power Control Signals>

Signal	Description
PWGIN	High active input for the QsevenR module indicates that all power rails located on the carrier board are ready for use.
PWRBTN#	Power Button: Low active power button input. This signal is triggered on the falling edge.

2.3.12<Power Management Signals>

Signal	Description
RSTBTN#	Reset button input. This input may be driven active low by an external circuitry to reset the QsevenR module.
BATLOW#	Battery low input. This signal may be driven active low by external circuitry to signal that the system battery is low or may be used to signal some other external battery management event.
SUS_STAT#	Suspend Status: indicates that the system will be entering a low power state soon.
SUS_S3#	S3 State: This signal shuts off power to all runtime system components that are not maintained during S3 (Suspend to Ram), S4 or S5 states. The signal SUS_S3# is necessary in order to support the optional

	S3 cold power state.
SUS_S5#	S5 State: This signal indicates S4 or S5 (Soft Off) state.
SLP_BTN#	Sleep button. Low active signal used by the ACPI operating system to transition the system into sleep state or to wake it up again. This signal is triggered on falling edge.

2.3.13<Miscellaneous Signals>

Signal	Description
WDOOUT	Watchdog event indicator. High active output used for signaling a missing watchdog trigger. Will be deasserted by software, system reset or a system power down.
SMB_CLK	Clock line of System Management Bus.
SMB_DAT	Data line of System Management Bus.
SMB_ALERT#	System Management Bus Alert input. This signal may be driven low by SMB devices to signal an event on the SM Bus.
SPKR	Primary functionality is output for audio enunciator, the "speaker" in PC AT systems.
BIOS_DISABLE#	Module BIOS disable input signal. Pull low to disable module's on-board BIOS. Allows off-module BIOS implementations. This signal can also be used to disable standard boot firmware flash device and enable an alternative boot firmware source, for example a boot loader.

2.3.14<Thermal Management Signals>

Signal	Description
THRM#	Thermal Alarm active low signal generated by the external hardware to indicate an over temperature situation. This signal can be used to initiate thermal throttling.

2.4 < VGA Interface >

Connector: **CN_CRT**

Type: onboard 10-pin connector for CN_CRT connector pitch 2.00mm

Pin	Signal	Pin	Signal
1	5VCDA	2	5VCLK
3	CRTGND	4	BR
5	BG	6	BB
7	5HSYNC	8	5VSYNC
9	CRTGND	10	CRTGND

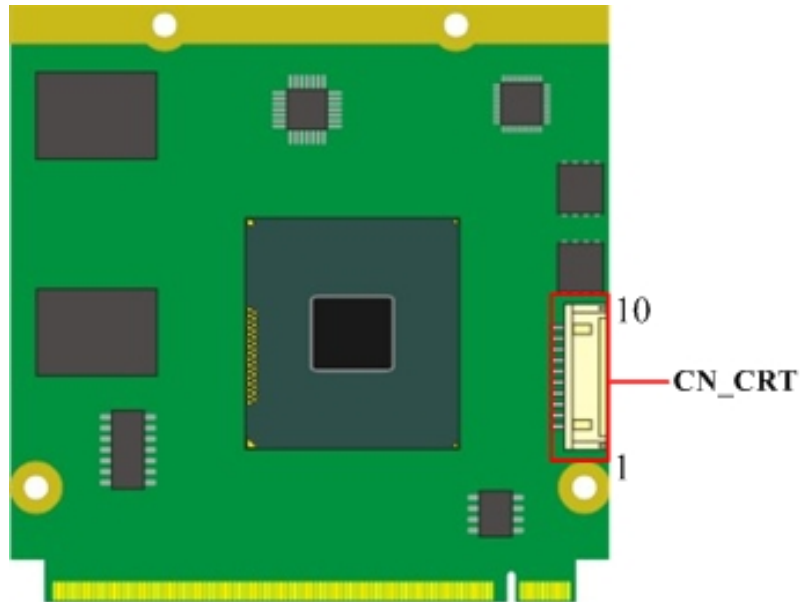

Chapter 3 <System Setup>

3.1 <Audio Configuration>

The board integrates REALTEK® ALC262 code. It can support 2-channel sound under system configuration. Please follow the steps below to setup your sound system.

1. Install REALTEK HD Audio driver.
2. Launch the control panel and Sound Effect Manager.

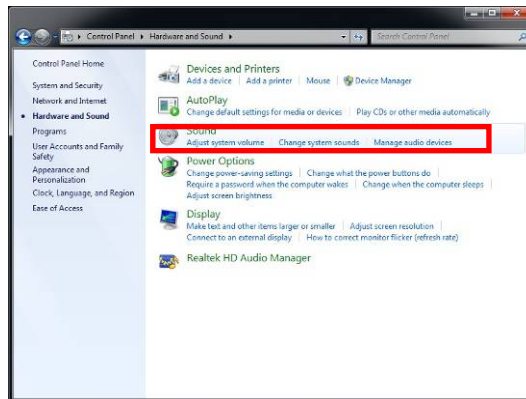

3. Select Speaker Configuration

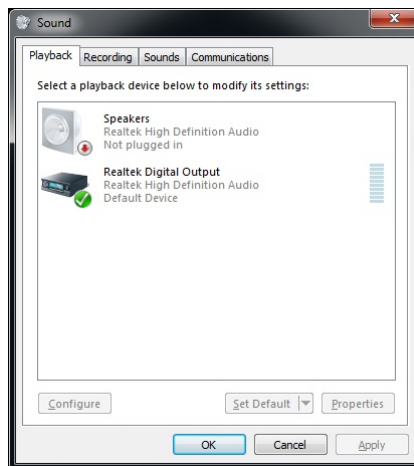

3.2 <Display Properties Setting>

Based on Intel J1900/N2930 with HD Graphic, the board supports two DACs for display device as different resolution and color bit.

Please install the Intel Graphic Driver before you starting setup display devices.

1. Click right button on the desktop to lunch **Screen resolution > Advanced settings**

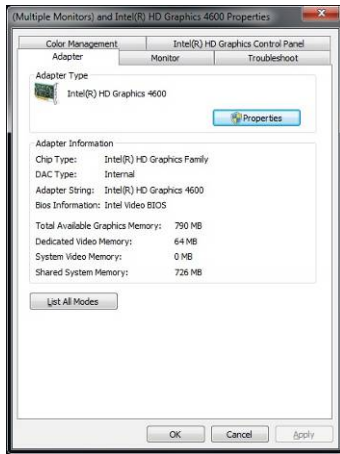

2. Click **Graphics Properties...** button for more specificity setup.

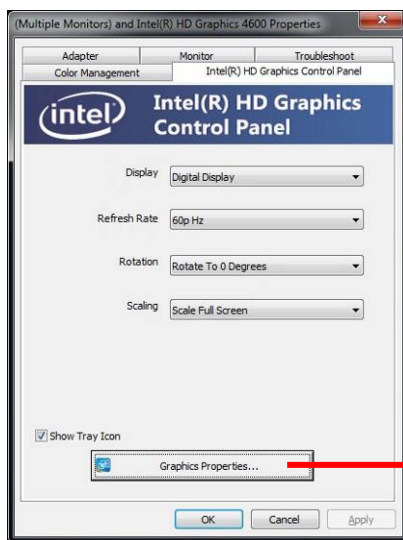

Click Graphics Properties... for advanced setup

3. This setup options can let you define each device settings.

Click **Display Settings** to setup the CRT monitor for Resolution and Refresh Rate

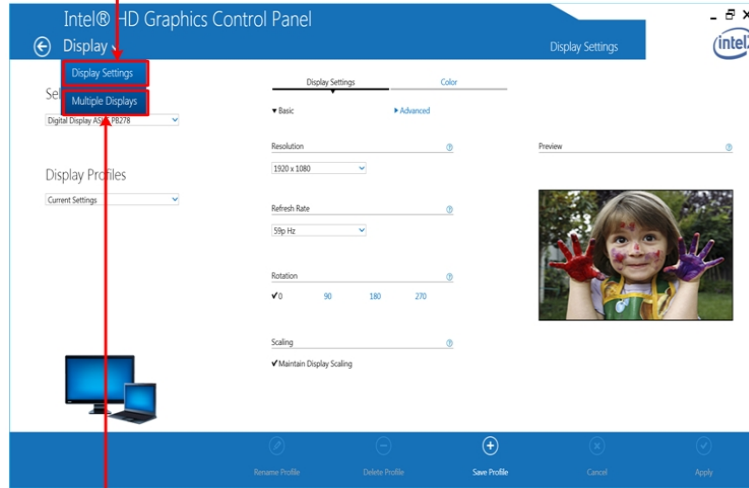

Click **Multiple Displays** to setup the dual display mode as same screen

3.3 <SATA configuration>

SATA Mode:

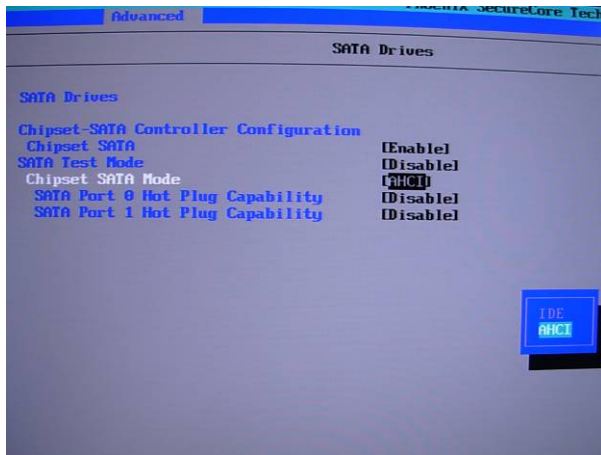

This option can let you select whether the Serial ATA hard drives would work under normal **IDE** or **AHCI**.

3.4 <USB3.0 configuration>

The USB3.0 port need to Install **USB 3.0 eXtensible Host Controller Driver** and enable **xHCI Mode**.

3.4.1 < USB 3.0 eXtensible Host Controller Driver install >

Step1. Copy the USB 3.0 driver from “Driver CD” to the local hard driver directory.

(Do not run this driver from a USB storage device)

Step2. Configure default BIOS, click Advanced > South Cluster Configuration > USB Configuration, disable “EHCI Mode”.

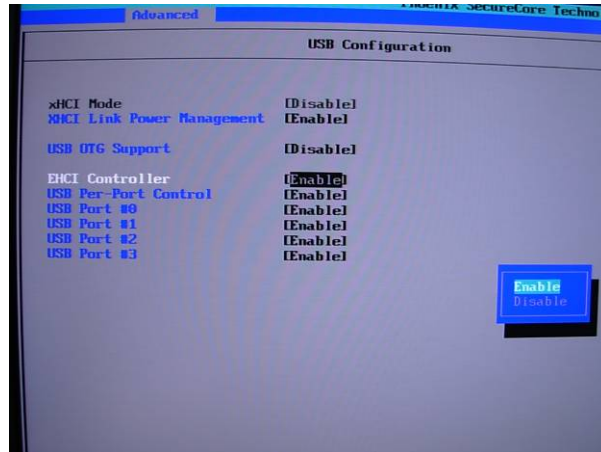

Step3. enable “xHCI Mode” and push “F10” to save configuration. Restart your computer.

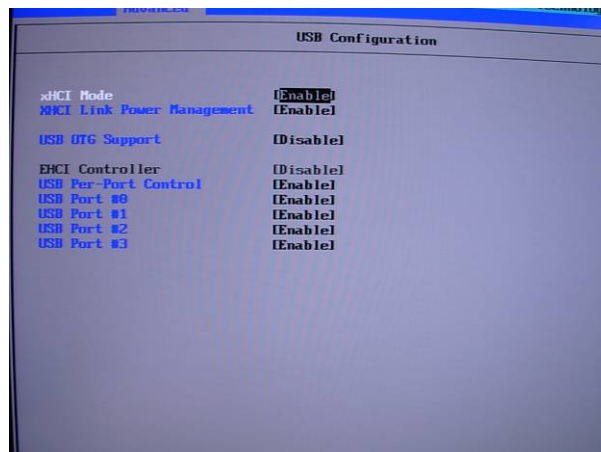

Step4. If you enable xHCI Mode , USB 2.0 and USB 3.0 ports can't use without drive. We recommend that you connect PS/2 mouse / keyboard installing USB 3.0 driver.

Step5. Double click the "Setup.exe" from the directory. Click "Next" to continue.



Step6. Lastly, the "Setup Complete" screen appears so click "Finish" to restart your computer.



Chapter 4 <BIOS Setup>

The motherboard uses the Phoenix BIOS for the system configuration. The Phoenix BIOS in the single board computer is a customized version of the industrial standard BIOS for IBM PC AT-compatible computers. It supports Intel x86 and compatible CPU

architecture based processors and computers. The BIOS provides critical low-level support for the system central processing, memory and I/O sub-systems.

The BIOS setup program of the single board computer let the customers modify the basic configuration setting. The settings are stored in a dedicated battery-backed memory, NVRAM, retains the information when the power is turned off. If the battery runs out of the power, then the settings of BIOS will come back to the default setting.

The BIOS section of the manual is subject to change without notice and is provided here for reference purpose only. The settings and configurations of the BIOS are current at the time of print, and therefore they may not be exactly the same as that displayed on your screen.

To activate CMOS Setup program, press key immediately after you turn on the system. The following message "Press DEL to enter SETUP" should appear in the lower left hand corner of your screen. When you enter the CMOS Setup Utility, the Main Menu will be displayed as **Figure 4-1**. You can use arrow keys to select your function, press <Enter> key to accept the selection and enter the sub-menu.

Figure 4-1 CMOS Setup Utility Main Screen

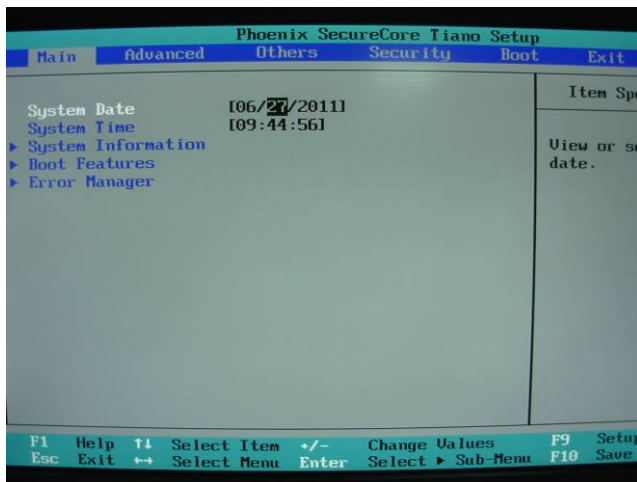

Appendix A <Flash BIOS>

A.1 <Flash Tool>

The board is based on Phoenix BIOS and can be updated easily by the BIOS auto flash tool. You can download the tool online from below link

<http://www.commell.com/Support/Product%20Technical%20Support/LN-D70.htm>

A.2 <Flash BIOS Procedure>

1. Extract the zip file(re-flash tool and BIOS file) to root of the USB flash drive.
2. Insert your USB flash drive in USB port of the board and power on the system.
3. Boot to EFI-Shell mode (**UEFI Boot Enable, Legacy Boot Disable**)

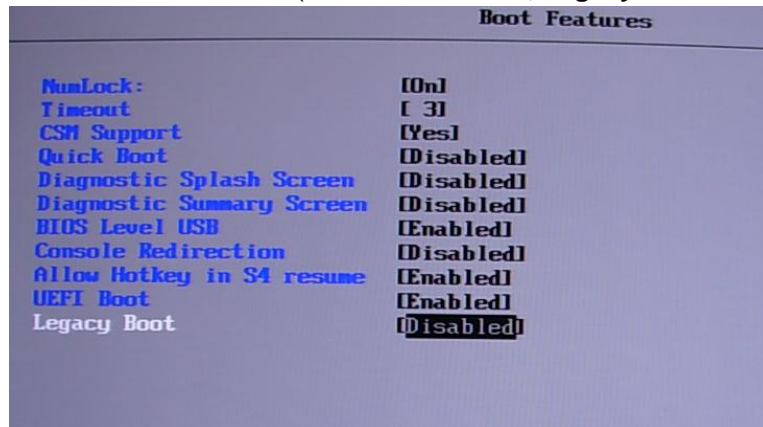

then input the "fs0:" command to switch to the root of the USB flash drive.

```

Device mapping table
fs0 :Removable HardDisk - Alias hd31a0d0b blk0
      Acpi (PNP0A03,0) /Pci (1D10) /Usb (0,0) /Usb (3,0) /HD (Part1,Sig0001624F)
blk0 :Removable HardDisk - Alias hd31a0d0b fs0
      Acpi (PNP0A03,0) /Pci (1D10) /Usb (0,0) /Usb (3,0) /HD (Part1,Sig0001624F)
blk1 :HardDisk - Alias (null)
      Acpi (PNP0A03,0) /Pci (1310) /Sata (0,0,0) /HD (Part1,SigD002A069)
blk2 :HardDisk - Alias (null)
      Acpi (PNP0A03,0) /Pci (1310) /Sata (0,0,0) /HD (Part2,SigD002A069)
blk3 :HardDisk - Alias (null)
      Acpi (PNP0A03,0) /Pci (1310) /Sata (0,0,0) /HD (Part3,SigD002A069)
blk4 :BlockDevice - Alias (null)
      Acpi (PNP0A03,0) /Pci (1310) /Sata (0,0,0)
blk5 :Removable BlockDevice - Alias (null)
      Acpi (PNP0A03,0) /Pci (1D10) /Usb (0,0) /Usb (3,0)

Press ESC in 1 seconds to skip startup.nsh, any other key to continue.
hell> fs0:_

```

4. Type the " **fpt64.efi -y -f xxx.bin**" command to start flash BIOS processes. (xxx.bin means the BIOS file that you want to update)
5. When it finished all update processes, restart the system.

Any question about the BIOS re-flash please contact your distributors or visit the web-site at below:

<http://www.commell.com.tw/support/support.htm>

Appendix B <Programming GPIO's>

The GPIO' can be programmed with the MSDOS debug program using simple IN/OUT commands. The following lines show an example how to do this. (The GPIO is open drain)

GPIO0.....GPIO7 bit0.....bit7

```

-o 4E 87                ;enter configuration
-o 4E 87
-o 4E 07
-o 4F 07                ;enable GPIO function
-o 4E 30
-o 4F 10                ;enable GPIO configuration
-o 4E F0
-o 4F xx                ;set GPIO as input/output; set '1' for input,'0'for
output

```

- o 4E F1
- o 4F xx ;if set GPIO's as output,in this register its value can be set

Optional :

- o 4E F2
- o 4F xx ; Data inversion register ; '1' inverts the current valus of the bits , '0' leaves them as they are
- o 4E 30
- o 4F 01 ; active GPIO's

For further information, please refer to NCT6106D datasheet.

Appendix C <Programming Watchdog Timer >

The watchdog timer makes the system auto-reset while it stops to work for a period.

The integrated watchdog timer can be setup as system reset mode by program.

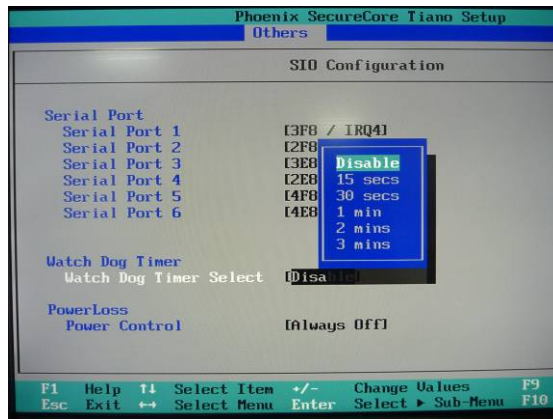

Timeout Value Range

- 1 to 255
- Second or Minute

Program Sample

The integrated Watchdog Timer can be set up by programming.

- O 4E 87 Enter configuration
- O 4E 87

-O 4E 07	Logic Device Enable
-O 4F 08	
-O 4E 30	WDT Enable
-O 4F 01	
-O 4E F0	Set as Second*
-O 4F 00	
-O 4E F1	
-O 4F 0A	Set reset time 10 Sec

You can select Timer setting in the BIOS, after setting the time options, the system will reset according to the period of your selection.

Contact Information

Any advice or comment about our products and service, or anything we can help you please don't hesitate to contact with us. We will do our best to support you for your products, projects and business.

Taiwan Commate Computer Inc.

Address	19F., No.94, Sec. 1, Xintai 5th Rd., Xizhi Dist., New Taipei City 22102, Taiwan
TEL	+886-2-26963909
FAX	+886-2-26963911
Website	http://www.commell.com.tw
E-Mail	info@commell.com.tw (General Information) tech@commell.com.tw (Technical Support)
Facebook	https://www.facebook.com/pages/Taiwan-Commate-Computer-Inc/547993955271899
Twitter	https://twitter.com/Taiwan_Commamate

Commell is a brand name of Taiwan commate computer Inc.