

## 4 W non-isolated, wide input-voltage range SMPS demonstration board based on the VIPer16

### Introduction

The purpose of this document is to provide information for the STEVAL-ISA071V2 switched mode power supply (SMPS) demonstration board. The STEVAL-ISA071V2 is a non-isolated SMPS capable of delivering a 4 W output over a wide input voltage range, and is designed for a mains application requiring -5 V and +7 V, referred to neutral. The basic concepts used in this design can also be applied for higher power outputs or different voltage ranges.

The SMPS generates outputs of 5 V and 12 V, referred to the output marked -5 V. The 5 V is dedicated to supplying an MCU. This configuration allows the use of the MCU to directly drive a Triac (referred to neutral). The 12 V output is used to supply additional circuits (relays, OA, etc.).

This document contains a fundamental technical description of the demonstration board (schematic diagram, PCB details and bill of materials) and basic measurements (load regulation, efficiency, standby behavior and EMI data).

**Figure 1. STEVAL-ISA071V2 board**



---

# Contents

<b>1</b>	<b>Main characteristics</b> .....	<b>4</b>
<b>2</b>	<b>Board connections</b> .....	<b>5</b>
<b>3</b>	<b>Board details</b> .....	<b>6</b>
3.1	Schematic diagram .....	6
3.2	Description of main components .....	7
3.3	Transformer .....	8
3.4	PCB details and layout .....	8
3.5	Bill of materials .....	10
<b>4</b>	<b>Measurements</b> .....	<b>11</b>
<b>5</b>	<b>Revision history</b> .....	<b>13</b>

## List of figures

Figure 1.	STEVAL-ISA071V2 board . . . . .	1
Figure 2.	Input/output connection of SMPS . . . . .	5
Figure 3.	STEVAL-ISA071V2 circuit schematic . . . . .	6
Figure 4.	PCB layout - top layer, bottom SMD layer and bottom copper layer . . . . .	9
Figure 5.	Efficiency at 120 VAC and 230 VAC . . . . .	11
Figure 6.	Load characteristics of 12 V output at 120 VAC and 230 VAC . . . . .	11
Figure 7.	EMI measurement for EN55022 Class B - AVG detector . . . . .	12
Figure 8.	EMI measurement for EN55022 Class B - peak detector . . . . .	12

# 1 Main characteristics

- Input:
  - $V_{IN}$ : 85 - 264 V<sub>RMS</sub>
  - f: 45 - 66 Hz
- Output:
  - 12 VDC  $\pm$  10% (referred to -5 V), 160 mA
  - -5 VDC  $\pm$  4%, 400 mA
  - Max output power: 4 W (range is up to 6 W for EU)
- Standby power: 35 mW at 230 VAC
- Short-circuit protected
- PCB data:
  - Single-sided, 35  $\mu$ m FR4
  - 33 x 45 mm (effective size of SMPS circuitry)
- Isolation: non-isolated, N connected to output GND
- EMI: compliant with EN55022 Class B

## 2 Board connections

The STEVAL-ISA071V2 demonstration board is pictured in [Figure 2](#) below, with input and output locations.

**Figure 2.** Input/output connection of SMPS

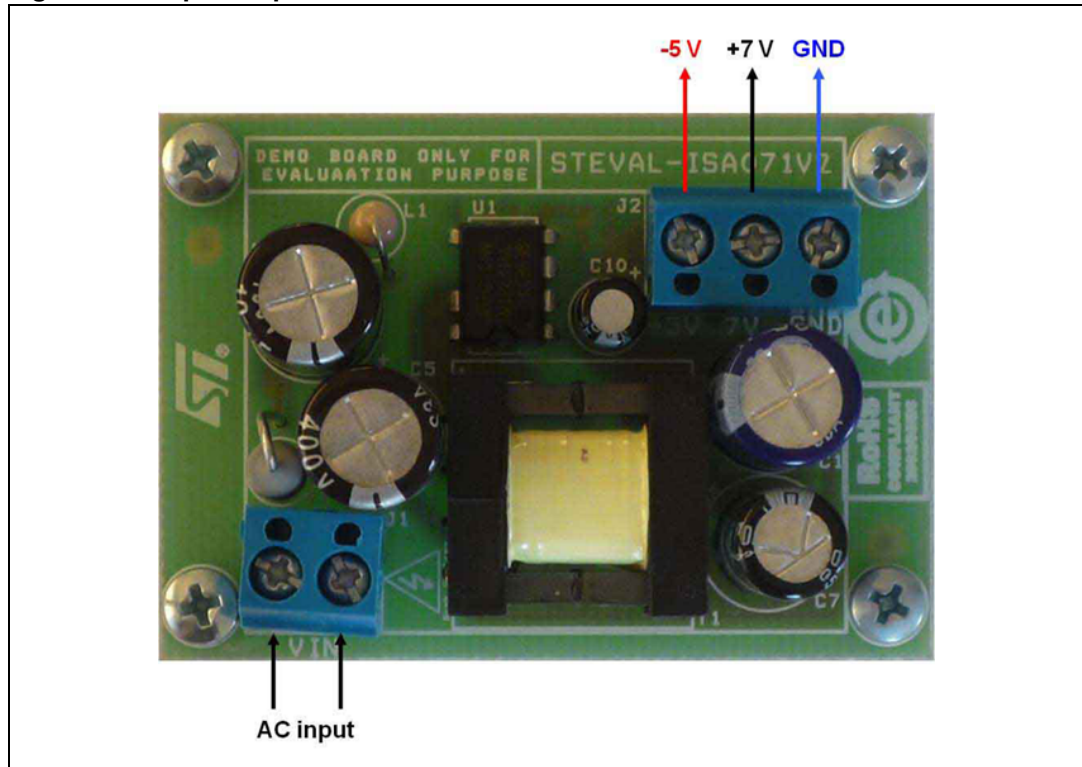

### 3 Board details

#### 3.1 Schematic diagram

A schematic diagram of the non-isolated flyback converter board prototype based on the VIPer16 is provided in [Figure 3](#) below.

**Figure 3. STEVAL-ISA071V2 circuit schematic**

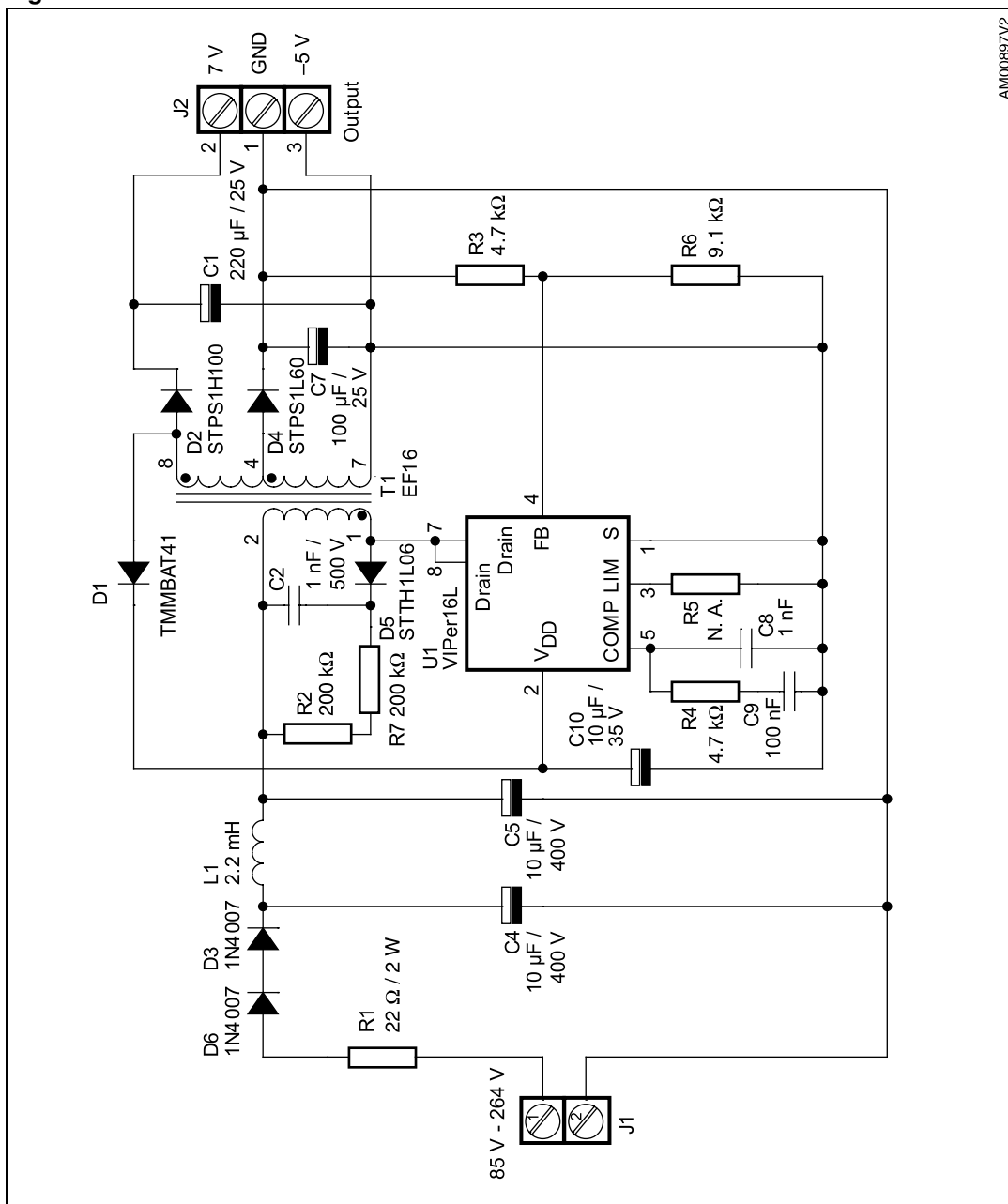

AM00897V2

## 3.2 Description of main components

The complete converter application consists of an input section and the flyback converter itself.

The input section contains:

- **Single diode rectifier (D3, D6)**  
The single diode rectifier is selected to allow simple connection of neutral to GND and reduce components count.
- **Inrush current limiter (R1)**  
This component reduces the inrush current caused by connection of the SMPS to mains (charging current of bulk capacitors) or by surge pulses.
- **EMI filter (L1, C4, C5)**  
This basic EMI filter using bulk capacitors and a simple inductor can be applied due to the single rectifier.
- **Input bulk capacitors (C4, C5)**  
These capacitors store energy when the input AC voltage is low.

The flyback converter consists of:

- **VIPer16 (U1)**  
This device integrates a controller and high voltage power MOSFET in one package. The controller works in current mode with a fixed frequency, in discontinuous mode. Thanks to the built-in error amplifier, the VIPer16 can directly sense the output voltage via a voltage divider. Mandatory components for proper operation of the VIPer16 are  $V_{DD}$  capacitor C10 and compensation network R4, C8 and C9. Diode D1 is not mandatory but it connects the output voltage to  $V_{CC}$  of the Viper16, reducing standby consumption.
- **Peak clamp (D5, R2, R7, C2)**  
This circuit absorbs energy from the voltage spike present after MOSFET turn-off. This spike is generated by leakage inductance of the transformer.
- **Secondary side (D2, D4, C1, C7)**  
This consists of two rectifiers and capacitors for each output. The -5 V output is used for feedback regulation. The main benefit of this solution is the connection of the source of the VIPer16 to -5 V. This allows direct sensing of -5 V from the output and simplifies the circuit. Another benefit of this method is the possibility to supply the VIPer16 from 12 V secondary winding (7 V to -5 V). This configuration results in a significant reduction in component count and, thanks to the internal error amplifier, permits reaching a low tolerance of -5 V. The special feature of this configuration is the fact that the current flowing from the input bulk capacitor through the primary side of the transformer and power MOSFET is closed back to the input capacitor via secondary side capacitor C7, and this capacitor is partly discharged during the ON time. Due to this effect, the use of a low ESR capacitor for C7 is highly recommended.

### 3.3 Transformer

The transformer was developed in cooperation with EPCOS and is available through order number T5684-51-01. The transformer specification is as follows:

- E16/8/5 - 60 kHz, voltage range 85 VAC - 264 VAC
- Core shape E16/8/5
- Core material N87
- Core Al 100 nH (0.29 mm gap)
- Bobbin 8-pin - B66308 - B663080A1108T001

**Table 1. Transformer windings**

Layer	Start pin	Stop pin	Number of turns	Wire number	Wire diameter	Wire material	Inductance	Position
1	1	2	157	1	0.2	Cu2l	2450 $\mu$ H	Primary
2	8	4	16	1	0.3	Cu2	26 $\mu$ H	Out +7 V
3	4	7	13	1	0.3	Cu2	17 $\mu$ H	Out -5 V

### 3.4 PCB details and layout

The layout of PCB is based on a one-sided FR4, with a 35  $\mu$ m thickness. The total size of the PCB is 41 x 58 mm, and the PCB space occupied by electronic circuitry is 33 x 45 mm. The layout of the PCB is provided in [Figure 4](#).



Figure 4. PCB layout - top layer, bottom SMD layer and bottom copper layer

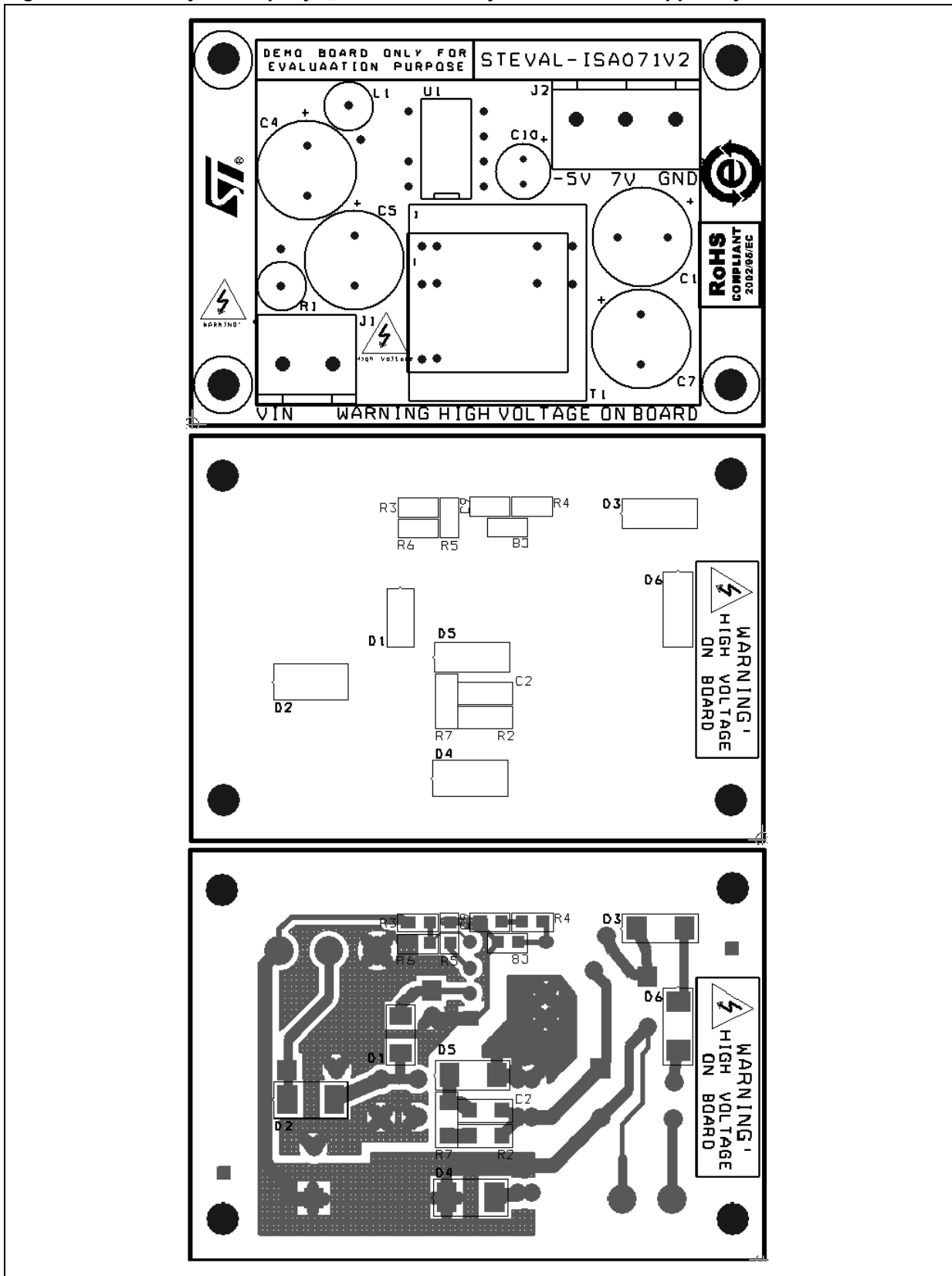

### 3.5 Bill of materials

Table 2. Bill of materials

Number	Quantity	Ref.	Value / generic part number	Package / class	Manufacturer
1	1	R1	22 $\Omega$ / 2 W / 5%		
2	2	R2, R7	200 k $\Omega$ / 5%	1206	
3	1	R3	4.7 k $\Omega$ / 1% / 0.1 W	0805	
4	1	R4	4.7 k $\Omega$ / 5% / 0.1 W	0805	
5	1	R6	9.1 k $\Omega$ / 1% / 0.1 W	0805	
6	2	C1, C7	100 $\mu$ F / 25 V / 105 $^{\circ}$ C	D8 RM 5	Rubycon
7	1	C2	1 nF / 500 V	1206	
8	2	C4, C5	10 $\mu$ F / 400 V / 105 $^{\circ}$ C	D10 x 20 RM 5	
9	1	C8	1 nF / 50 V	0805	
10	1	C9	100 nF / 50 V	0805	
11	1	C10	10 $\mu$ F / 35 V / 105 $^{\circ}$ C		
12	1	L1	2.2 mH / 80 mA		
13	1	T1	EF16	T5684-51-01	EPCOS
14	1	D1	TMMBAT41	SOD80	
15	1	D2	STPS1H100	SMA	STMicroelectronics
16	2	D3, D6	SMD 1N4007	MELF / SMA	
17	1	D4	STPS1L60	SMA	STMicroelectronics
18	1	D5	STTH1L06	SMA	STMicroelectronics
19	1	U1	VIPER16	DIP-7	STMicroelectronics
20	1	J1	Screw terminal 2 pos.	RM 5 mm	
21	1	J2	Screw terminal 3 pos.	RM 5 mm	

## 4 Measurements

The basic measurements for efficiency, load characteristics and conductive EMI are shown in [Figure 5](#), [Figure 6](#), [Figure 7](#) and [Figure 8](#).

**Figure 5. Efficiency at 120 VAC and 230 VAC**

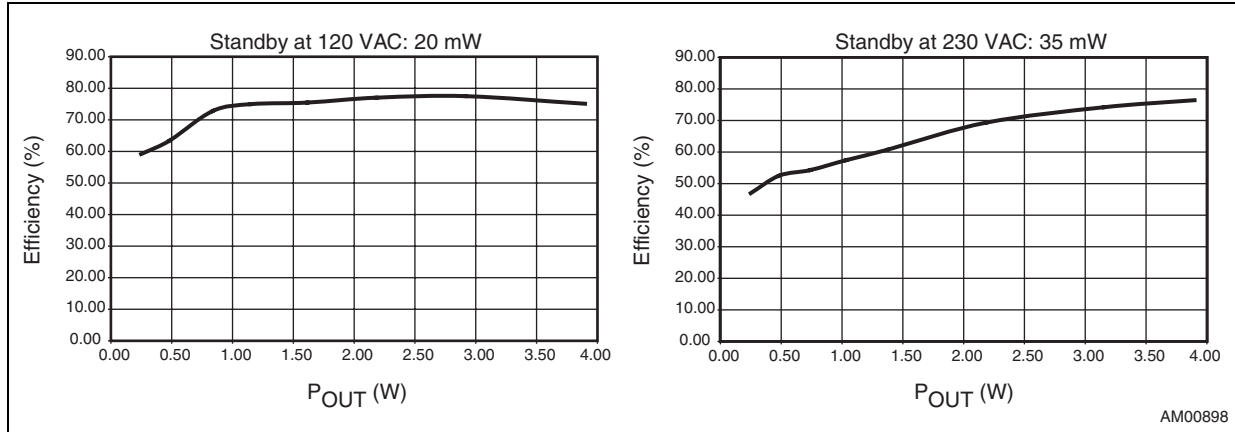

**Figure 6. Load characteristics of 12 V output at 120 VAC and 230 VAC**

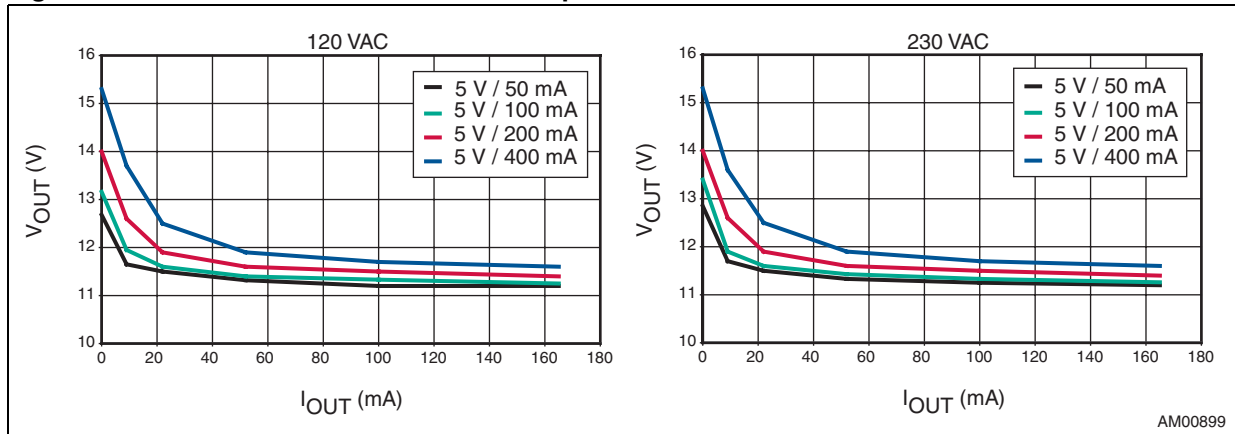

Figure 7. EMI measurement for EN55022 Class B - AVG detector

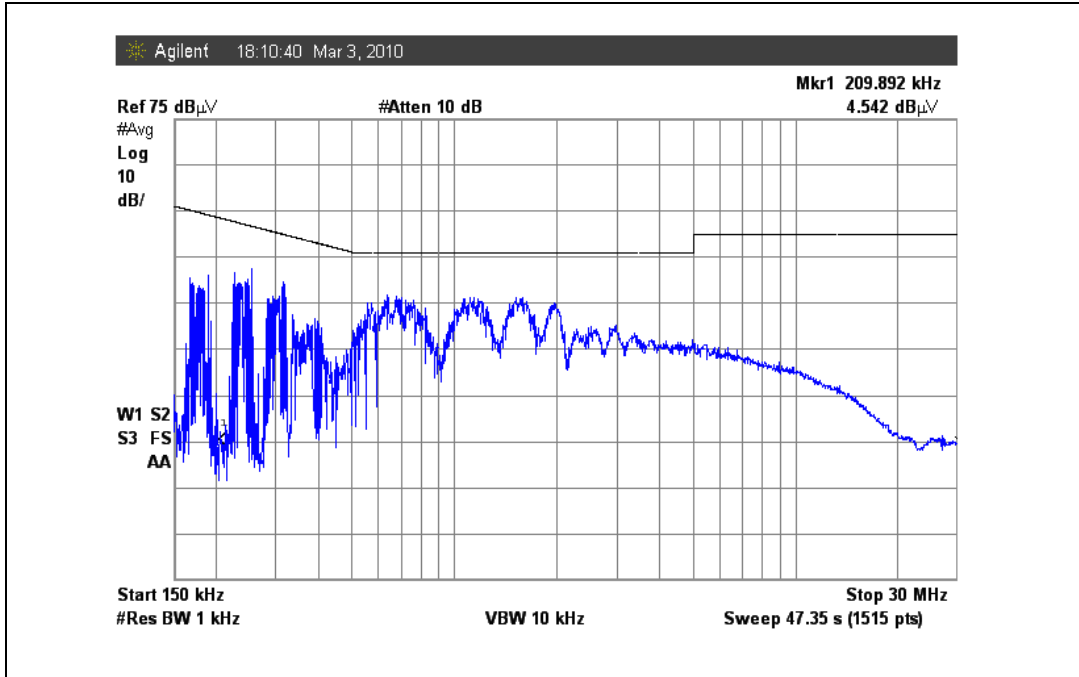
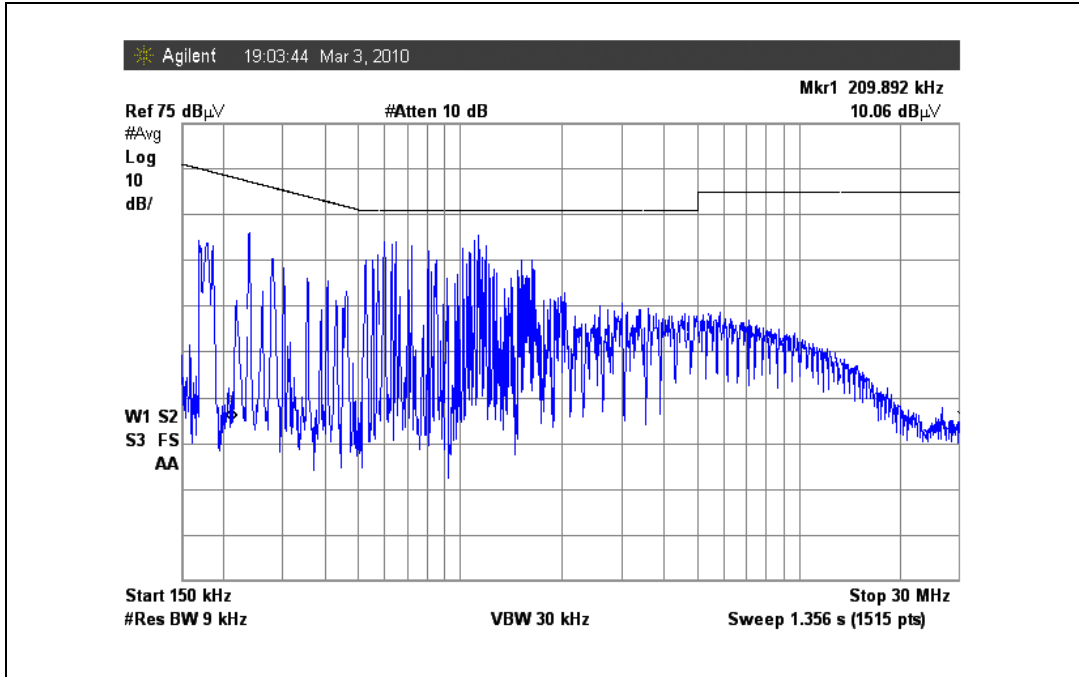

Figure 8. EMI measurement for EN55022 Class B - peak detector



## 5 Revision history

**Table 3. Document revision history**

Date	Revision	Changes
28-Jun-2010	1	Initial release.
03-May-2012	2	Replaced STEVAL-ISA071V1 by STEVAL-ISA071V2, updated <a href="#">Figure 1</a> to <a href="#">Figure 4</a> and Disclaimer, minor text corrections throughout document.

**Please Read Carefully:**

Information in this document is provided solely in connection with ST products. STMicroelectronics NV and its subsidiaries ("ST") reserve the right to make changes, corrections, modifications or improvements, to this document, and the products and services described herein at any time, without notice.

All ST products are sold pursuant to ST's terms and conditions of sale.

Purchasers are solely responsible for the choice, selection and use of the ST products and services described herein, and ST assumes no liability whatsoever relating to the choice, selection or use of the ST products and services described herein.

No license, express or implied, by estoppel or otherwise, to any intellectual property rights is granted under this document. If any part of this document refers to any third party products or services it shall not be deemed a license grant by ST for the use of such third party products or services, or any intellectual property contained therein or considered as a warranty covering the use in any manner whatsoever of such third party products or services or any intellectual property contained therein.

**UNLESS OTHERWISE SET FORTH IN ST'S TERMS AND CONDITIONS OF SALE ST DISCLAIMS ANY EXPRESS OR IMPLIED WARRANTY WITH RESPECT TO THE USE AND/OR SALE OF ST PRODUCTS INCLUDING WITHOUT LIMITATION IMPLIED WARRANTIES OF MERCHANTABILITY, FITNESS FOR A PARTICULAR PURPOSE (AND THEIR EQUIVALENTS UNDER THE LAWS OF ANY JURISDICTION), OR INFRINGEMENT OF ANY PATENT, COPYRIGHT OR OTHER INTELLECTUAL PROPERTY RIGHT.**

**UNLESS EXPRESSLY APPROVED IN WRITING BY TWO AUTHORIZED ST REPRESENTATIVES, ST PRODUCTS ARE NOT RECOMMENDED, AUTHORIZED OR WARRANTED FOR USE IN MILITARY, AIR CRAFT, SPACE, LIFE SAVING, OR LIFE SUSTAINING APPLICATIONS, NOR IN PRODUCTS OR SYSTEMS WHERE FAILURE OR MALFUNCTION MAY RESULT IN PERSONAL INJURY, DEATH, OR SEVERE PROPERTY OR ENVIRONMENTAL DAMAGE. ST PRODUCTS WHICH ARE NOT SPECIFIED AS "AUTOMOTIVE GRADE" MAY ONLY BE USED IN AUTOMOTIVE APPLICATIONS AT USER'S OWN RISK.**

Resale of ST products with provisions different from the statements and/or technical features set forth in this document shall immediately void any warranty granted by ST for the ST product or service described herein and shall not create or extend in any manner whatsoever, any liability of ST.

ST and the ST logo are trademarks or registered trademarks of ST in various countries.

Information in this document supersedes and replaces all information previously supplied.

The ST logo is a registered trademark of STMicroelectronics. All other names are the property of their respective owners.

© 2012 STMicroelectronics - All rights reserved

STMicroelectronics group of companies

Australia - Belgium - Brazil - Canada - China - Czech Republic - Finland - France - Germany - Hong Kong - India - Israel - Italy - Japan - Malaysia - Malta - Morocco - Philippines - Singapore - Spain - Sweden - Switzerland - United Kingdom - United States of America

[www.st.com](http://www.st.com)