

# CAN OBDII SCANNER



## USER'S MANUAL

Version: 8.08

# Table of Contents

<b>1.0 - Introduction</b>	
1.1 The Product	3
1.2 Safety Precautions	5
1.3 Vehicle Service Information	8
1.4 Introduction to On-Board Diagnostics (OBD) II	10
1.5 Diagnostic Link Connector (DLC)	11
<b>2.0 -The Scan Tool</b>	
2.1 Main Unit	12
2.2 Keypad Functions	13
2.3 Getting Started	13
2.4 Brightness Control	14
<b>3.0 -Vehicle Diagnosis</b>	
3.1 START SCANNING	15
3.2 READ DTC	18
3.3 ERASE DTC	21
3.4 LIVE DATA	22
3.4.1 OBD-II Generic Operational Data Items	24
3.5 FREEZE FRAME DATA	26
3.6 MIL STATUS	27
3.7 I/M [M&R Status]	29
3.8 O2 SENSOR TEST	31
3.9 VIN (Vehicle Information)	34
<b>4.0 – Appendix</b>	
4.1 Appendix A – PID Definitions	35
4.2 Appendix B – Glossary	37
4.3 Appendix C – Supported Vehicle Models List	48
4.5 Appendix D – What is EOBD, EOBD2 and OBD-II	56
<b>5.0 – Notice</b>	
5.1 Disclaimer	62
<b>6.0 – Warranty Information</b>	
6.1 Limited Warranty	62
6.2 Limitations of Warranty	63

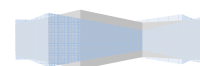

## 1.0 - Introduction

---

### 1.1-The Product:

#### CAN OBDII SCANNER

*This Scan tool is designed for all OBDII / EOBD compliant cars. With over 12,000 DTCs (fault codes) found in its data base, it covers all generic OBDII / EOBD codes such as Powertrain (P0,P2 and P34xx), Body (B0), Chassis (C0) and Network (U0) as well as some Manufacturers specific codes (P1,P30xx and U1).*

*The car owner as well as technicians can use this tool to diagnose the engine problem when the 'Check Engine Light' illuminates on the dashboard meter. It retrieves the Error Codes (DTC) and Freeze Frame Data from the vehicle computer (PCM) and displays them on the LCD screen with DTC definitions.*

*The displayed 'LIVE DATA' readings are very useful for technicians as it saves time when diagnosing the problem. Besides Vehicle Information (VIN), IM Readiness Monitor status, MIL status, it also tests Oxygen Sensors.*

*Once you have the diagnostic information from the PCM, this is the first step in finding and fixing the problem.*

*Please take note of these important points:*

- *Diagnostic Trouble Code (DTC) warns us of a problem or symptom has occurred with a particular engine system, not a specific part.*
- *The vehicle computer can only report Diagnostic Trouble Code (DTC) based on what its sensors had relayed to it.*
- *There are some instances that sensors appeared to be bad when in actual fact, they are not.*

*The main causes were:*

- *Poor connections at the connector, broken wire or short circuit may prevent the sensor signal from reaching the vehicle computer.*
- *Failure of one system may affect the sensor in another system to give false results.*
- *It is recommended that use of the vehicle service manual to assist in the diagnosing process is important.*

*The next step in the diagnostic process is to test the systems and parts which were suspected to be defective.*

Once the faults had been identified and repaired, you can use the tool to CLEAR the fault codes (DTCs) from the PCM memory. This will turn off the Malfunction Indicator Lamp (MIL) or Check Engine Light.

**Product Features:**

	<i>CAN OBDII SCANNER</i>
Displays the DTC definitions on screen	Yes
Supports CAN bus, J-1850 VPW, J-1850 PWM, ISO-9141, KWP 2000 protocols	Yes
Reads and Clears all Generic OBDII / EOBD and some Manufacturers specific DTCs	Yes
Resets 'Check Engine' light	Yes
Views 'Freeze Frame' data	Yes
Determines the Malfunction Indicator Lamp (MIL) status	Yes
I/M Monitor and Readiness Status	Yes
Retrieves the Vehicle Identification Number (VIN)	Yes
Displays 'Live' data streams	Yes
Oxygen (O2) Sensor Test	Yes

**Specifications:**

*LCD Display:* Blue back light, 128 x 64 pixels (FSTN) with contrast adjustment.

*Operating temperature:* -20°C ~ 50°C (-4°F ~ 122°F)

*Input Voltage:* DC 9.0 ~ 15.0 V (through OBDII connector)

*Supported Protocols:*  
 (SAE) J-1850 PWM  
 (SAE) J-1850 VPW  
 ISO 9141-2  
 KWP 2000 (ISO-14230)  
 CAN bus (ISO-15765-4)  
 EOBD

*Vehicle coverage:* All American vehicles from year 1996 onward to the current models. All makes that are OBDII and EOBD compliant.

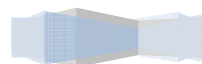

## **1.2 - Safety Precautions**



*For safety reasons, read this manual thoroughly before operating the Tool.*

*Always refer to and follow the safety instructions and testing procedures provided by the car or equipment manufacturer. The safety messages presented below and throughout this user's manual are reminders to the operator to exercise extreme care when using this test instrument.*

### **Read All Instructions**

*Read, understand and follow all safety messages and instructions in this manual and on the test equipment. Safety messages in this section of the manual contain a signal word with a three-part message and, in some instances, an icon.*

### **Safety Messages**

*Safety messages are provided to help prevent personal injury and equipment damage. All safety messages are introduced by a signal word. The signal word indicates the level of the hazard in a situation.*

*The types of safety messages are.*



**Indicates a possible hazardous situation which, if not avoided, will result in death or serious injury to operator or bystanders.**



**Indicates a possible hazardous situation which, if not avoided, could result in death or serious injury to operator or bystanders.**



**Indicates a possible hazardous situation which, if not avoided, may result in moderate or minor injury to operator or bystanders.**



**Indicates a condition which, if not avoided, may result in damage to test equipment or vehicle**

## Safety Precautions



**⚠ DANGER**

When the engine is running, it produces carbon monoxide, a toxic and poisonous gas. Always operate the vehicle in a well ventilated area. Do not breathe exhaust gases – they are hazardous that can lead to death.



**⚠ CAUTION**

To protect your eyes from propellant object such as caustic liquids, always wear safety eye protection.



**⚠ DANGER**

Fuel and battery vapors are highly flammable.  
**DO NOT SMOKE NEAR THE VEHICLE DURING TESTING.**



**⚠ CAUTION**

When engine is running, many parts (such as pulleys, coolant fan, belts, etc) turn at high speed. To avoid serious injury, always be alert and keep a safe distance from these parts.



**⚠ WARNING**

Before starting the engine for testing or trouble shooting, always make sure the parking brakes is firmly engaged. Put the transmission in Park (automatic transmission) and Neutral (manual transmission).



**⚠ WARNING**

Always block the drive wheels.  
Never leave vehicle unattended while testing.



**⚠ CAUTION**

Never lay tools on vehicle battery. You may short the terminals together causing harm to yourself, the tools or the battery.

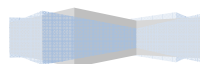

## Safety Precautions



**WARNING**

Connecting or disconnecting the test equipment when the ignition is ON can cause damage to the vehicle electrical components. Always turn ignition OFF before connecting or disconnect the tool from the Diagnostic Link Connector.



**CAUTION**

Engine parts become very hot when engine is running. To prevent severe burns, avoid contact with hot engine parts.



**WARNING**

Do not wear loose clothing or jewelry while working on engine. Loose clothing can get caught in fan, pulleys, belts, etc. Jewelry can conduct current and can cause severe burns if comes in contact between power source and ground.



**CAUTION**

When the engine is running, be cautious when working around the ignition coil, distributor cap, ignition wires and spark plugs. They are HIGH VOLTAGE components that can cause electrical Shock.

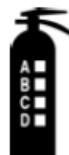

**IMPORTANT**

Always keep a fire extinguisher readily available and easily accessible in the workshop.

**CAUTION**

Some vehicles are equipped with SRS (Airbags). Caution must be taken when working around the air bag components or wiring. Always refer to the vehicle service manuals on the CAUTION remarks. If the cautions are not followed, the air bag may open up unexpectedly resulting in personal injury.

Note that the air bag can still open up several minutes after the ignition key is off or even the vehicle battery is disconnected because of a special energy reserve module.

Always follow the vehicle manufacturer's warnings, cautions and service procedures.



## 1.3 - Vehicle Service Information

The following is a list of web sites and phone numbers where electronic engine control (EEC) diagnostic information is available.

- ✓ Some manuals may be available at your local dealer, auto parts stores or local public libraries.

Domestic Vehicles	Web Site	Phone Number
<b>General Motors</b>		
Chevrolet	www.chevrolet.com	1-800-551-4123
Pontiac	www.pontiac.com	1-800-551-4123
Oldsmobile	www.oldsmobile.com	1-800-551-4123
Buick	www.buick.com	1-800-551-4123
Cadillac	www.cadillac.com	1-800-333-4CAD
Saturn	www.saturn.com	1-800-553-6000
<b>Ford</b>		
Ford	www.ford.com	1-800-392-3673
Lincoln	www.lincoln.com	1-800-392-3673
Mercury	www.mercury.com	1-800-392-3673
<b>Chrysler</b>		
Chrysler	www.chrysler.com	1-800-348-4696
Dodge	www.dodge.com	1-800-348-4696
Plymouth	Not Available	1-800-348-4696
Eagle	Not Available	1-800-348-4696
<b>European Vehicles</b>		
Audi	www.audi.com	1-800-544-8021
Volkswagen	www.vw.com	1-800-544-8021
BMW	www.bmw.com	1-201-307-4000
MINI	www.mini.com	1-201-307-4000
Jaguar	www.jaguar.com	1-800-4-JAGUAR
Volvo	www.volvo.com	1-800-458-1552
Mercedes-Benz	www.mercedes-benz.com	1-800-367-6372
Land Rover	www.landrover.com	1-800-637-6837
Porsche	www.porsche.com	1-800-PORSCHE
Saab	www.saab.com	1-800-955-9007

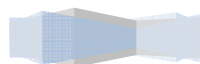



## Asian Vehicles

Acura	<a href="http://www.acura.com">www.acura.com</a>	1-800-999-1009
Honda	<a href="http://www.honda.com">www.honda.com</a>	1-800-999-1009
Lexus	<a href="http://www.lexus.com">www.lexus.com</a>	1-800-255-3987
Scion	<a href="http://www.scion.com">www.scion.com</a>	1.866.70.SCION
Toyota	<a href="http://www.toyota.com">www.toyota.com</a>	1-800-GO-TOYOTA
Hyundai	<a href="http://www.hyundai.com">www.hyundai.com</a>	1-800-633-5151
Infiniti	<a href="http://www.infiniti.com">www.infiniti.com</a>	1-800-662-6200
Nissan	<a href="http://www.nissanusa.com">www.nissanusa.com</a>	1-800-nissan1
Kia	<a href="http://www.kia.com">www.kia.com</a>	1-800-333-4542
Mazda	<a href="http://www.mazda.com">www.mazda.com</a>	1-800-222-5500
Daewoo	<a href="http://www.daewoo.com">www.daewoo.com</a>	1-822-759-2114
Subaru	<a href="http://www.subaru.com">www.subaru.com</a>	1-800-SUBARU3
Isuzu	<a href="http://www.isuzu.com">www.isuzu.com</a>	1-800-255-6727
Geo	Not Available	Not Available
Mitsubishi	<a href="http://www.mitsubishi.com">www.mitsubishi.com</a>	1-888-MITSU2004
Suzuki	<a href="http://www.suzukiauto.com">www.suzukiauto.com</a>	1-800-934-0934

## Other Manuals

Chilton Book Company	<a href="http://www.chiltonsonline.com">www.chiltonsonline.com</a>	1-800-347-7707
Haynes Publications	<a href="http://www.haynes.com">www.haynes.com</a>	1-800-242-4637
Bentley Publishers	<a href="http://www.bentleypublishers.com">www.bentleypublishers.com</a>	1-800-423-4595

## Repair Information Programs

Mitchell	<a href="http://www.mitchell1.com">www.mitchell1.com</a>	1-888-724-6742
ALLDATA	<a href="http://www.alldata.com">www.alldata.com</a>	1-800-697-2533

## Suitable Manual Titles

Diagnostic Service Manuals  
 Power Train Codes and Oxygen Sensors  
 Automotive Emission Control Manual  
 Fuel Injection  
 Automotive Electrical Manual  
 Automotive Electrics and Electronics  
 Automotive Sensors  
 Electronic Transmission Control  
 Emission Control Technology  
 Engine Management or other similar titles...

## **1.4 - Introduction to On-Board Diagnostics (OBD) II**

On-board diagnostics version II (OBD II) is a system that the Society of Automotive Engineers (SAE) developed to standardize automotive electronic diagnosis.

Beginning in 1996, most new vehicles sold in the United States were fully OBD II compliant and in year 2000, Europe started its own EOBD system.

- ✓ Technicians can now use the same tool to test any OBD II / EOBD compliant vehicles without special adapters. SAE established guidelines that provide:
  - ❑ A universal connector, called the Diagnostic Link Connector (DLC) with dedicated pin assignments.
  - ❑ A standard location for the DLC, visible under the dash on driver's side.
  - ❑ A standard list of diagnostic trouble codes (DTCs) used by all manufacturers.
  - ❑ A standard list of parameter identification (PID) data used by all manufacturers.
  - ❑ Ability for vehicle systems to record operating conditions when a fault occurs.
  - ❑ Expanded diagnostic capabilities that records a code whenever a condition occurs that affects vehicle emissions.
  - ❑ Ability to clear stored codes from the vehicle's memory with a Scan Tool.

### **SAE Publications**

SAE has published hundreds of pages of text defining a standard communication protocol that establishes hardware, software, and circuit parameters of OBD II systems.

- SAE publishes recommendations, not laws, but the Environmental Protection Agency (EPA) and California Air Resources Board (CARB) made many of SAE's recommendations legal requirements.

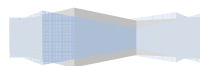

## 1.5 - Diagnostic Link Connector (DLC)

The Data Link Connector (DLC) is used with scan tool to communicate with the vehicle's control module.

- ✓ Data Link Connector Location.
- Under dashboard on driver side of vehicle.
- If Data Link Connector is not located under dashboard, a label should be there telling location.

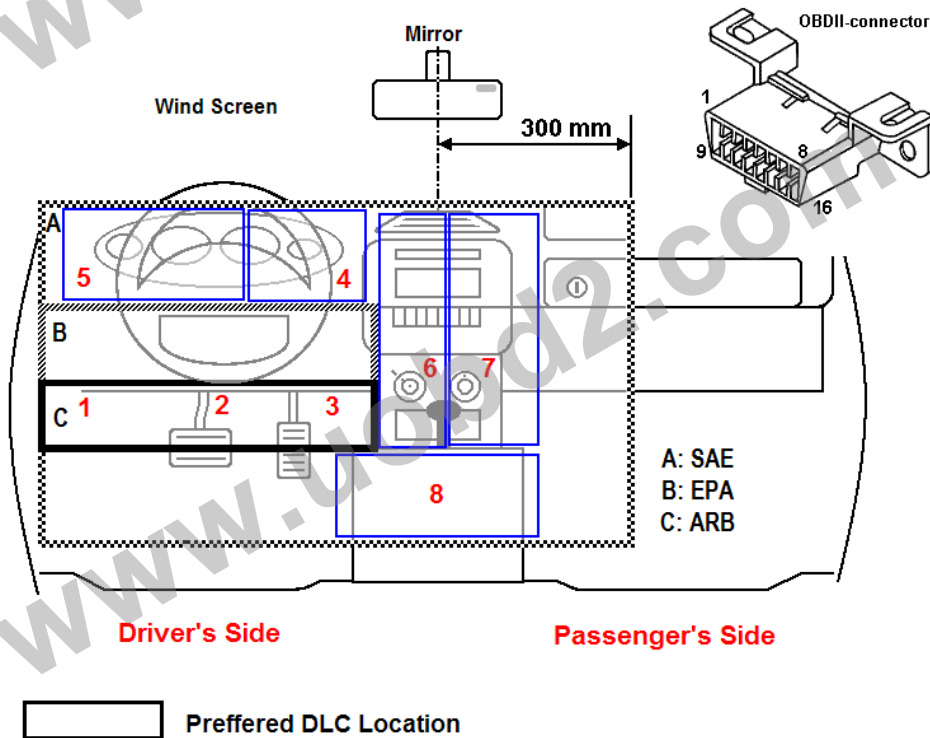
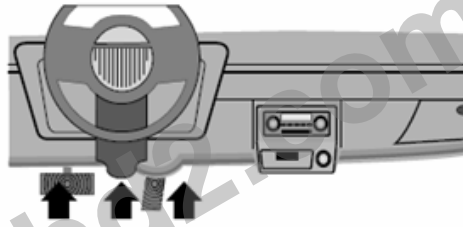

Location #	Description
<b>1</b>	Driver's side, underneath dashboard, in the area under the steering column, +/- 150mm (i.e., +/- 6 inches on either side of the steering column)
<b>2</b>	Driver's side, underneath dashboard, between the driver-side door and steering column area.
<b>3</b>	Driver's side, underneath dashboard, between the steering column area and the center console (also includes connectors on the driver side but connected to the center console)
<b>4</b>	Driver's side, dashboard instrument / gauge area, between the steering column and the centre console.
<b>5</b>	Driver's side, dashboard instrument / gauge area, between the driver-side door and steering column.
<b>6</b>	Center console, vertical surface (i.e., near radio and climate controls), left of vehicle centerline.
<b>6,7</b>	Center console, vertical surface (i.e., near radio and climate controls), on vehicle centerline.
<b>7</b>	Center console, vertical surface right of vehicle centerline or on passenger side of center console.
<b>8</b>	Center console, horizontal surface (i.e., armrest, handbrake area), in front passenger area
<b>9</b>	Any location other than locations # 1~8 (i.e., rear passenger area, passenger side glove box, top of dashboard near windshield)

**Note:**

- Locations # **1 ~ 3** represent preferable locations.
- Locations # **4 ~ 8** represents allowable locations under SAE J9162.
- Connectors in location #**6**, #**6, 7** and #**7** may be covered by ashtrays, covers, cup holders, coin holders, etc.

## 2.0 - The Scan Tool

### 2.1 - Main unit



Figure 1

## **2.2 - Keypad Functions:**



This [OK] key is to confirm the selected function.



Pressing this [ESC] key will exit the current function and back to the previous page.



This button permits two functions namely; to scroll [UP] to the next item and to adjust the screen contrast brighter.



This button permits two functions namely; to scroll [DOWN] to the next item and to adjust the screen contrast darker.

## **2.3 - Getting Started:**



Before you use Scan Tool on the vehicle, please ensure that mechanical problems such as low oil level, damaged hoses, wiring or electrical connections are fixed FIRST. They may cause a fault code to set.

The following Areas need to be checked before starting any test:

- The levels of engine oil, power steering fluid, transmission fluid (if auto transmission), engine coolant and other fluids must be at proper level. Top up if necessary.
- Check the condition of air hoses and the air filter must be cleaned. Replace if necessary.
- Make sure the timing belts are in good conditions and properly tensioned.

- Make sure the spark plugs are cleaned and in good condition. Check for loose, damaged, disconnected or missing plug cables.
- Make sure that all mechanical linkages to the engine sensors (throttle, gearshift position, transmission, etc) are secure and properly connected. Refer to Service Manuals for locations.
- Check all electrical wirings and harnesses for proper connections and condition of its insulation.
- Check all rubber hoses (radiator) and steel hoses (vacuum and fuel) for leaks, cracks, blockage or other damages.
- Make sure the engine is mechanically sound. Do a compression check, engine vacuum check, timing check, etc.
- Always refer to the manufacturer's Service Manual if you are not sure of the repair procedures.

## **2.4 – Brightness Control**

- 1、 Once the Scan Tool is powered up through the DLC connection, the LCD screen lights up. Pressing and hold  key will increase the LCD brightness.
- 2、 Likewise, pressing and hold  key will decrease the brightness.

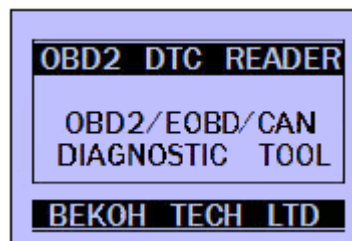

Figure 2

## 3.0 - Vehicle Diagnosis

### 3.1 - START SCANNING

When everything had been confirmed and checked as mentioned in **Getting Started**, the testing operation can be carried out.

1. Locate the vehicle Diagnostic Link Connector (DLC) and make sure that the ignition switch is in OFF position. (Figure 3)

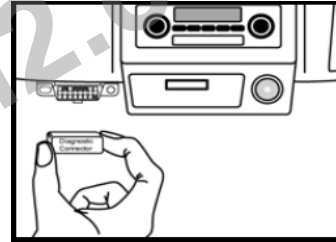

Figure 3

2. Connect the scan tool diagnostic connector to the vehicle DLC.

If problem of inserting, rotate it to 180° and try again

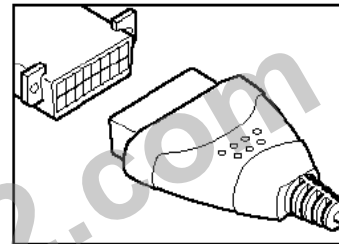

Figure 4

3. When the connection has been established, the LCD screen wakes up displaying as shown:

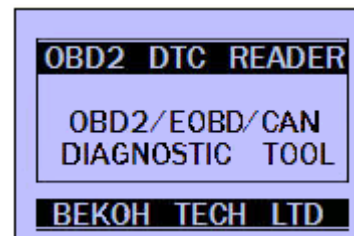

Figure 5



- Turn the ignition key to ON.  
**DO NOT** start or crank the engine.  
(Figure 6)

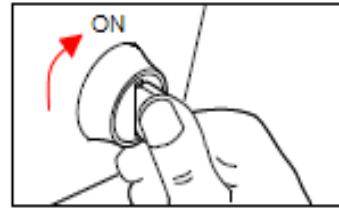



Figure 6

- Press  key, the screen will change to as shown (Figure 7).

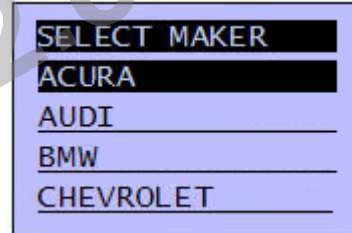



Figure 7

- Press  or  key to select the car maker according to the car made that need to be tested or if it is not in the menu then selects [Generic OBDII] (Figure 8).

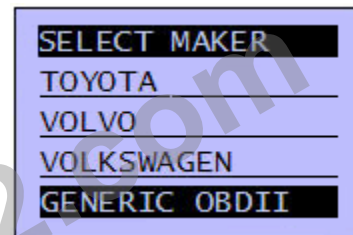



Figure 8

*Note: Press and hold either key will make the scrolling action faster.*

- After the selection, press  key to confirm and the scan tool will proceed the test. (Figure 9)

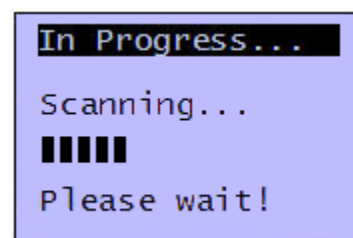
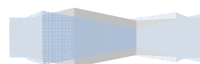

Figure 9



- If the Scan tool fails to link up with the vehicle's computer, it will show a message as displayed on the LCD screen: (Figure 10)

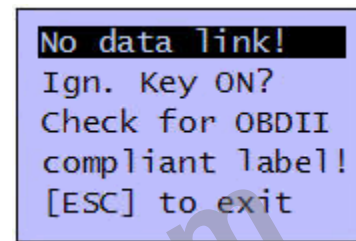

Figure 10

**Possible causes:**

- The Diagnostic connector is not connected properly.
- Ignition Key is not turned ON.
- The vehicle is not OBDII compliant.

**Note:**

To check whether the vehicle being tested is OBDII compliant, always refer to the Vehicle Emission Control Information (VECI) decal located under the hood or by the radiator of most vehicles. See (Figure 11).

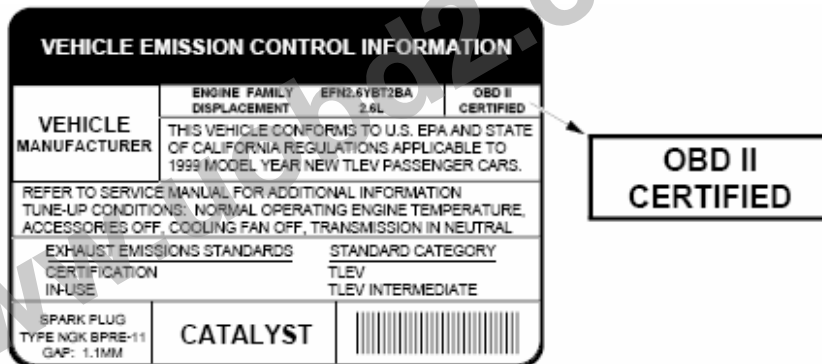

Figure 11

9. Once the scan tool has established communication with the engine ECU, it will display the protocol type. (Figure 12)

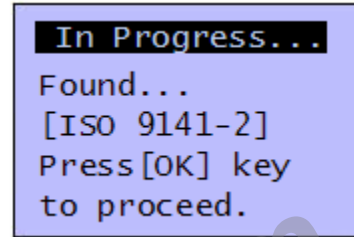



Figure 12

10. As instructed, press  to continue and it will enter into the main menu (Figure 13).

Here you can select the operation

you wish by pressing  or  key.

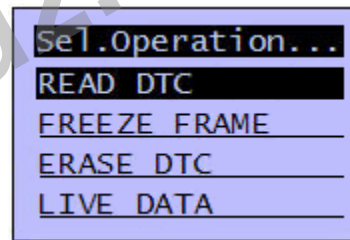



Figure 13

### 3.2 – READ DTC

- ✓ Selecting this function allows the Scan Tool to read the DTCs from the vehicle's control modules. DTCs are used to help determine the cause of a problem or problems within a vehicle. These codes cause the control module to illuminate the malfunction indicator lamp (MIL) when emission-related or drivability fault occurs. MIL is also known as service engine soon or check engine lamp (See figure ).
- ✓ **READ DTCs** can be done with the **Key On Engine Off (KOEO)** or with the **Key On Engine Running (KOER)**.

On the 'Read DTC' highlighted row

(Figure 13), pressing  key will proceed to the selection choice. (Figure 14).

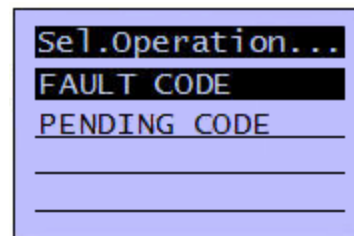
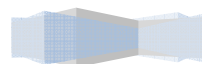

Figure 14



## Diagnostic Trouble Codes (DTC) or Fault Codes

Under OBDII / EOBD systems, all manufacturers must use a universal 5 digits code system.

These universal 5 digits codes are made up of:

- The **1<sup>st</sup>** character in the DTC indicates a letter which identifies the “main system” where the fault occurred (Power train, Body, Chassis or Network)
- The **2<sup>nd</sup>** character is a numerical digit which identifies “Generic or Manufacturer Specific”
- The **3<sup>rd</sup>** character is also a numerical digit which identifies the specific systems or sub-systems where the problem is located.
- The **4<sup>th</sup>** and **5<sup>th</sup>** characters are also numerical digits which identifies the section of the system that is malfunctioning.

### DTC Structure:

Example: **P0321** – Ignition/Distributor Engine Speed Input Circuit Range/Performance

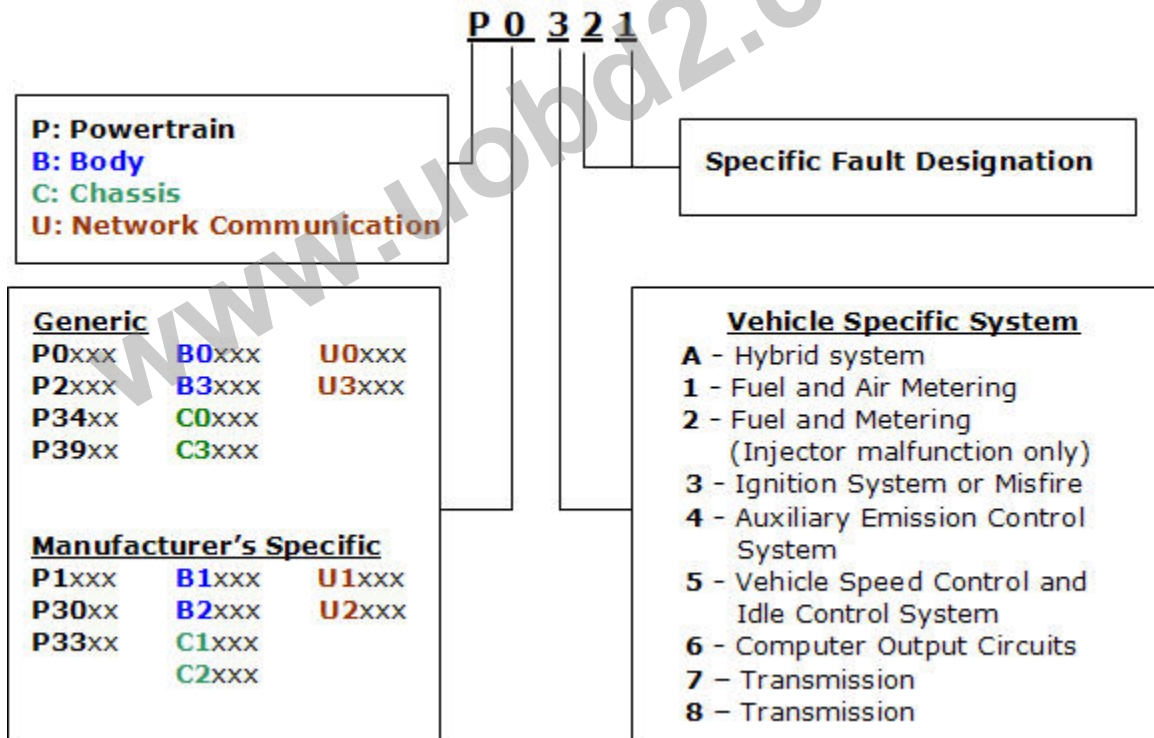

### Types of DTC:

There are two types of DTCs namely: One trip DTC and two trips DTC.

One trip DTC is a condition that requires immediate attention such as a catalyst damaging misfire.

Two trips DTC is one that a condition must be found during 2 consecutive trips such as an EGR fault.

'A Trip' is define as a Key-ON, Key-OFF event in which the powertrain control module (PCM) or ECU detects the following:

- Engine coolant temperature should change more than 20°C after starting the engine.
- Engine coolant temperature should exceed 70°C.
- Engine speed should go over 400 RPM.

An OBD TRIP is a journey during which all OBD tests have been completed or ready.

One trip monitor means that if a fault is detected, the engine computer will illuminate the MIL and a DTC will be placed as a stored **Fault Code**.

Two trips monitor means that if a fault is detected on the first trip, the engine computer will temporarily save this fault in its memory as a **Pending Code** (the MIL will be off). If the fault is detected again on a second consecutive trip, the engine computer will illuminate the MIL and a DTC will be placed as a stored **Fault Code**.

Depending on the choice of selection, once "Fault Code" or "Pending Code"

had been selected, press  key to confirm. The display screen will show the DTCs it had retrieved from the ECU memory (Figure 15).

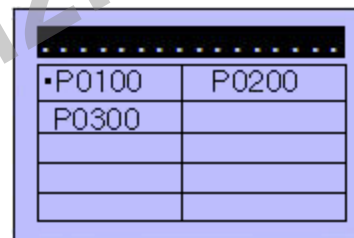

Figure 15

Press  or  key will display code definitions. (Figure 16)

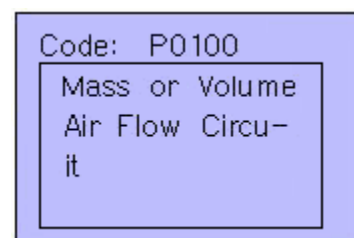

Figure 16

*Note: Pressing and hold either key will continue to scroll endlessly.*

If there is no DTC present in the ECU memory, then the display will show as follows: (Figure 17)

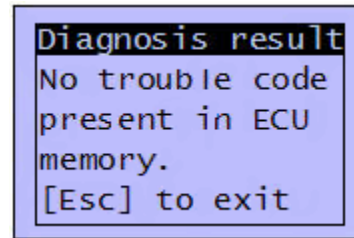

Figure 17

### 3.3 - ERASE DTCs

Selecting this function erases the *DTCs* from vehicle's control module(s) memory. Perform this function with KOEO. **Do not start the engine.**

- ✓ The **ERASE DTCs** function may also erase **Freeze Frame Data.....**
- ✓ The **ERASE DTCs** function resets all the **I/M Readiness** Monitor Status to a **NOT READY** condition. To set all of the Monitors to a **READY** status, an OBDII Drive Cycle must be performed. Please refer to the vehicle service manual for information on how to perform an OBDII Drive Cycle for the vehicle under test.

**Note:**

***If the tested vehicle has DTC present in its memory and need to be sent to the workshop for repair. Do not use this function to erase it. These DTC will help the technicians to troubleshoot the engine problem encountered.***

***Perform ERASE DTCs function only when the vehicle had been repaired.***

To start this function, go back to the previous menu (Figure 13) and select "Erase DTC" as shown (Figure 18) by

pressing the  key.

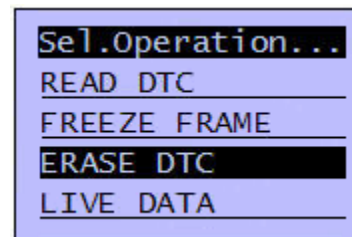



Figure 18

Press  key, the screen will display the message as shown (Figure 19).

To Erase DTC press  key otherwise press  key to exit.

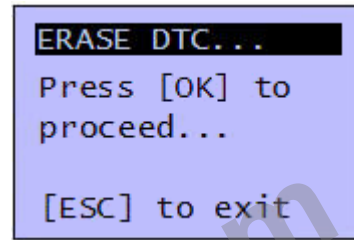



Figure 19

When  key was pressed, the screen will display the message as shown (Figure 20) if it has successfully erased the DTCs.

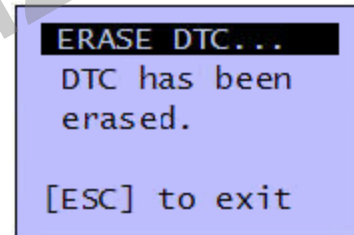



Figure 20

To Exit this function, press  key will return back to the main menu screen (Figure 18).

### 3.4 LIVE DATA

---

The **LIVE DATA** function allows real time viewing of the vehicles computer module's PID data. As the computer monitors the vehicle, information is simultaneously transmitted to scan tool.

To start this function, go back to the previous Menu (Figure 13) and select 'Live Data' row as shown (Figure 21).

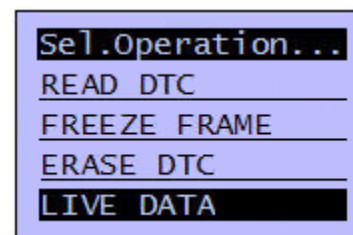
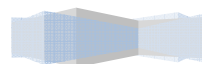



Figure 21





Press  key, the screen will change to: (Figure 22 & 23)

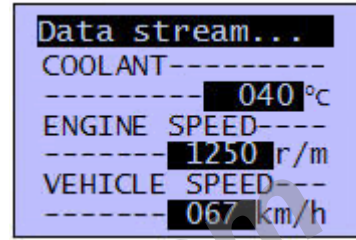



Figure 22

Use the  or  key to view other sensors data.

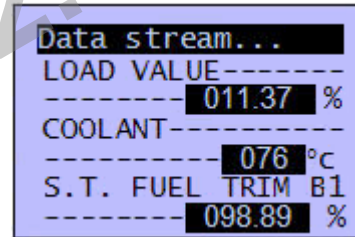

Figure 23

To Exit this function, press  key will return back to the main menu screen (Figure 13).

### **3.4.1 - OBD-II Generic Operational Data Items**

**Mass Air Flow (MAF)**                      **Range:**                      **0 to 105 gm/sec**  
High Performance Vehicles:                      **0 to 255 gm/sec**

Mass air flow sensor input is used by the PCM (vehicle computer) to calculate fuel delivery. As the air flow increases, the fuel delivery must also increase. The unit is displayed in grams per second.

**Calculated Load Value**                      **Range:**                      **0% to 100%**

An indication of the current airflow divided by peak airflow, where peak airflow is corrected for altitude, if available. This value is not engine specific. It gives the service technician an indication of the percentage of engine capacity being used (with a full load as 100%).

**Commanded Secondary Air Status**

Commanded Secondary Air provided to the exhaust system.

**Engine Coolant Temperature (ECT) Range: - 40 °C to 215 °C**

The temperature of the vehicle coolant is used to determine when to transition into closed loop and to calculate spark advance during cold starts. The PCM converts the voltage from the sensor to a temperature.

**Engine RPM** - Engine Speed reading displayed in revolutions per minute.

**Fuel Pressure (Gauge) Range: 0 to 765 kPa G**

Fuel pressure of the fuel delivery system.

**Fuel System Status** - Information describing the operation of the fuel control.

**Open Loop** - Operating condition during engine warm up/idle in which the fuel mixture is not being corrected to compensate for a rich/lean condition.

**Closed Loop** - Operating condition in which the fuel mixture is being corrected for a rich/lean condition.

**OL Drive** - Vehicle in Open Loop due to driving conditions (power enrichment, deceleration).

**OL Fault** - Vehicle in Open Loop due to a detected system fault.

**CL O2 Fault** - Vehicle in Closed Loop, but a fault with at least one oxygen sensor - may be using simple oxygen sensor for fuel control.

**Ignition Timing Advance Range: - 64° to 63.5°**

The relationship between ignition timing and top dead center, displayed in crankshaft degrees.

**Intake Air Temperature (IAT) Range: - 40 °C to 215 °C**

Temperature of the air drawn through a cleaner and distributed to each cylinder for use in combustion.

**Intake Manifold Pressure (MAP) Range: 10 to 105 kPa, or 0 to 5 Volts**

The manifold absolute pressure displayed in kilopascals or volts. A low reading will indicate that the pressure is low (vacuum is high) and a high reading will indicate that the pressure is high (vacuum is low).

**Long Term Fuel Trim [Bank 1 / Bank 2] (L.T. Fuel Trim - B1/B2)**

Long Term adjustments to the Bank 1 fuel calibration schedule which compensate for vehicle differences and gradual changes that occur over time.

**Range: -100.00% to 99.92%** (-100% indicates a maximum lean condition, 99.92% indicates a maximum rich condition, and 0% indicates no adjustment).

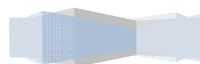

**OBD-II Require**

Requirement level for the On Board Diagnostics designed for the vehicle.

**OBD-II (CARB)** - Vehicle designed with OBD requirements for California Air Resource Board OBDII.

**OBD (Fed EPA)** - Vehicle designed with OBD requirements for Federal EPA OBD.

**OBD and OBD-II** - Vehicle designed with OBD requirements for OBD and OBDII.

**OBD-I** - Vehicle designed with OBD requirements for OBD-I.

**Not Intended** - Vehicle not intended to meet any OBD requirements.

**Oxygen Sensor**

The detection of Oxygen (O<sub>2</sub>) content in the exhaust gases. The sensor readings are used by the PCM to help calculate the air-fuel mixture to maintain proper vehicle performance.

**Short Term Fuel Trim [Bank 1/2] (S.T. Fuel Trim B1/B2)**

Dynamic or instantaneous adjustments to the Bank 1 base fuel schedule.

**Range:** -100.00% to 99.92% (-100% indicates a maximum lean condition, 99.92% indicates a maximum rich condition, and 0% indicates no adjustment).

**Vehicle Speed (MPH)** - Sensor reading displayed in miles per hour.

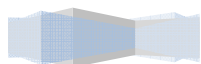

### 3.5 - FREEZE FRAME

When an emission-related fault has occurs, certain vehicle conditions are recorded by the on-board computer. This information is referred to as Freeze Frame data. It is a snapshot of the operating conditions at the time of an emission-related fault had occurred.

- ✓ **FREEZE FRAME** can be overwritten by faults with a higher priority.
- ✓ If DTCs were erased, it may not be stored in vehicle memory.

To access to this function, go back to the previous Menu (Figure 13) and select "Freeze Frame" (Figure 24).

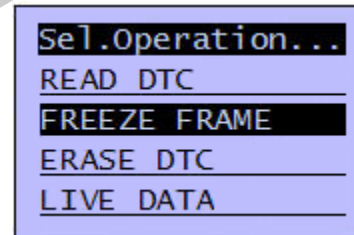



Figure 24

Press  key the screen will display the Freeze Frame data as shown (Figure 25 &26).

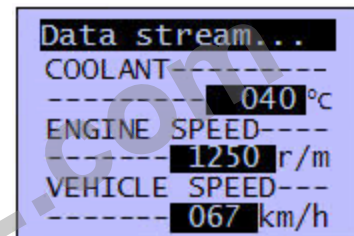



Figure 25

Use the  or  key to view other sensors data.

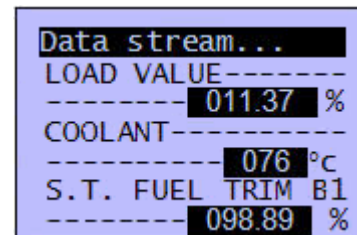

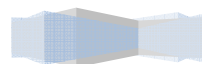

Figure 26

To Exit this function, press  key will return back to the main menu screen. (Figure 13)



### 3.6 - MIL STATUS

---

When the vehicle on board computer detects a problem in the emission related systems or components, its diagnostic program will assign a fault code (DTC) and store it in its memory. It also records a “Freeze Frame” of the conditions present when the fault was found and set the Malfunction Indicator Lamp (MIL) alight. Some faults require detection for two trips in a row before the MIL is turned on.

Three typical examples of MIL are shown below:



Figure 27

#### Definition of Trip

‘A Trip’ is define as a Key-ON, Key-OFF event in which the powertrain control module (PCM) detects the following:

- Engine coolant temperature should exceed 70°C
- Engine coolant temperature should change more than 20°C after starting the engine.
- Engine speed should go over 400 RPM.

When the powertain control module (PCM) detects a fault during the 1<sup>st</sup> trip, the DTC and the corresponding ‘Freeze Frame’ data are stored in the PCM’s memory.

The MIL will not light up until the fault is again detected during the 2<sup>nd</sup> trip. Certain DTCs are capable of turning the Malfunction Indicator Light (MIL) ‘ON’ or ‘blinking’ during the first trip.

To access to this function, go back to the previous Menu (Figure 13) and select "MIL" (Figure 28)

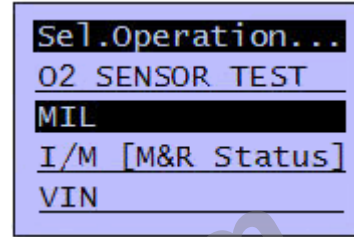



Figure 28

Press  key, the screen will display as shown (Figure 29).

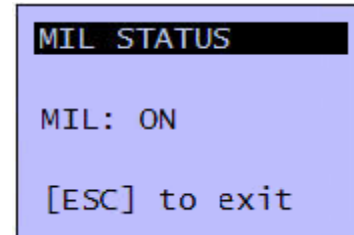

Figure 29

If there is no fault in the system, then the screen will display as shown (Figure 30).

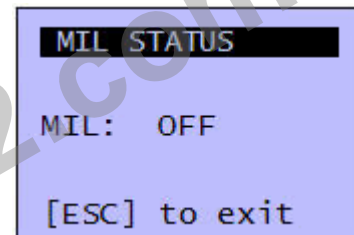
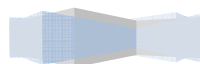

Figure 30

To Exit this function, press  key will return back to the main menu screen. (Figure 13)



### **3.7 - I/M [M&R Status]**

---

The **I/M** (Inspection / Maintenance) **[M&R Status]** (Monitors and Readiness Status) function is used to view a *snapshot* of the operations on the emission system on OBD II vehicles.

- ✓ I/M [M&R Status] is a very useful function. To guarantee no faults exist and to make sure all monitors are okay or not present and no DTCs exist.
- ✓ Always refer to the vehicles service manual for the Drive Cycle operation.
- ✓ During normal driving conditions, the vehicle's computer scans the Emission system. After a specific amount of drive time (each monitor has specific driving conditions and time required), the computer's monitors decide if the vehicles emission system is working correctly or not as well as detecting out of range values. When the monitor's status is:
  - **READY OR N.A**  
The vehicle was driven enough to complete the monitor and it is ready or completed. N.A means Not Available. (See "SUPPORTED" and "NO SUPPORT" for clarification).
  - **NOT READY**  
The vehicle was not driven enough to complete the monitor or when the scan tool had just performed "ERASE DTC" procedure on the ECU (See Figure 37).
  - **SUPPORTED**  
The vehicle supports this monitor and when it reports "READY OR N.A.", it means that it is ready. (See Figure 32 & 33)
  - **NO SUPPORT**  
The vehicle does not support this monitor and when it reports "READY OR N.A", it means that it is not available (See Figure 35 & 37).
- ✓ Depending on the vehicle, disconnecting or a discharged battery may erase DTCs and clear monitor status.
- ✓ Monitors may be cleared by:
  - Erasing DTCs
  - Vehicle control modules losing power



✓ **I/M Readiness** Monitor Status can be done with the KOER or KOEO.

To access to this function, go back to the main Menu (Figure 13) and select "I/M [M&R Status]": (Figure 31)

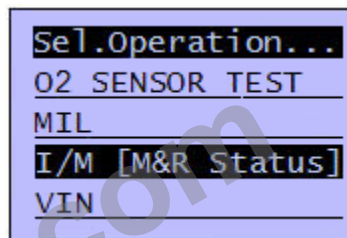



Figure 31

Press  key will enter this function and the screen will display as shown (Figure 32).

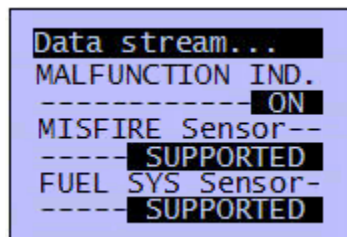



Figure 32

Press  or  key to view the rest of the monitors. (See some examples shown below).

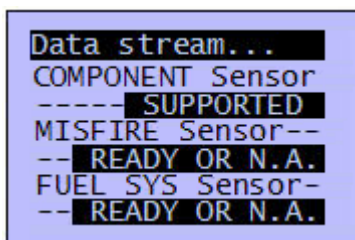

Figure 33

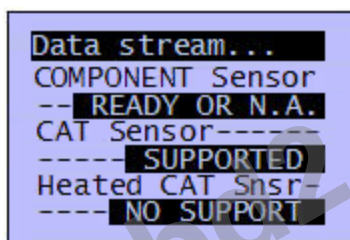

Figure 34

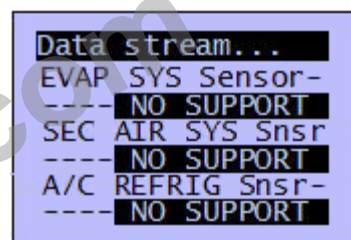

Figure 35

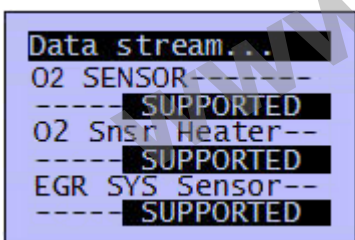

Figure 36

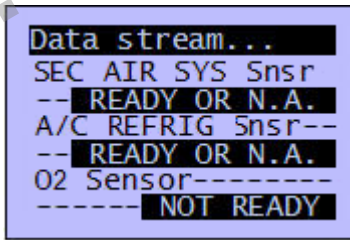

Figure 37

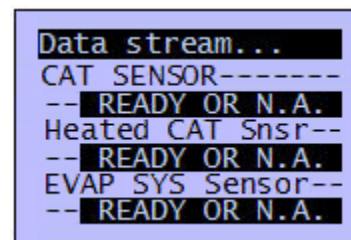



Figure 38

To Exit this function, press  key will return back to the main menu display screen (Figure 13).

### **3.8- O2 (OXYGEN) SENSOR TEST**

Oxygen or O2 sensors are used to provide information to the ECU the amount of unconsumed Oxygen in the exhaust gas exiting from the tailpipe. With this information, the ECU can determine the amount of Fuel / Air injection delivery and try to reach the best Stoichiometric ratio of 14.7 parts of fuel to 1 part of air (14.7:1) for best burning effect without polluting the environments. This proportion is known as **Lambda**.

A defective sensor can greatly affect the vehicle's fuel consumption because it allows the vehicle to use more fuel than what it should. Hence faulty sensors need to be diagnosed and replaced promptly.

But determining if the O2 sensor is really defective will need accurate diagnosis. Equipments like this OBD2 code reader can be used for this purpose.

The emission testing done by OBDII is more comprehensive than the tailpipe test because unlike the traditional tailpipe test, which provides the emission results of only a specific moment (only during testing), the OBD2 code reader can monitor the vehicle emission at various moments when the vehicle is in operation.

The first generation of OBD, called as OBDI provided a simplistic test to determine the health of the oxygen sensor. Oxygen sensor testing using OBD1 involved determining if the sensor was stuck lean or rich for 30 seconds or more. The OBDI systems didn't have any way to determine the response time of the oxygen sensors.

Oxygen sensor testing using OBD2 does look at the response time as well. A good upstream oxygen sensor produces an oscillating waveform that toggles between 0.1V to 0.9V. The sensor indicates 0.1V for lean mixture and 0.9V for rich air to fuel mixture. So the new OBD2 equipments can test how fast or slow the oxygen sensor transitions between lean and rich mixture levels and hence determines the response time of the oxygen sensor with known "good" values.

The response time of oxygen sensor may vary from 0.3 sec to 0.125 sec (depending on the oxygen sensor specification). Slower response time could be an indication of deposition of carbon or fuel on the sensor. Faster switching of the oxygen sensor output can cause misfiring. Emission problems related to engine misfire will make the OBDII lamp to flash. A P0300 code will be set in the event of an engine misfire. Further diagnosis is needed to determine why the cylinder is misfiring.

Another diagnosis that can be done using OBD2 system is determining the efficiency of catalytic converter. The output of downstream oxygen sensor, located after the catalyst is compared with the upstream oxygen sensor

located before the catalytic converter. In an efficiently working catalytic converter, the upstream oxygen sensor will switch between lean and rich voltages, but the downstream oxygen sensor will have much fewer voltage switching. If the converter efficiency is poor (due to contamination), the downstream O2 sensor output will look like the upstream O2 sensor output; that is the post cat oxygen sensor will switch more frequently between lean and rich voltage levels just like the pre cat oxygen sensor.

To help to understand the terms used during the test, please refer to the pre-catalytic voltage sample waveform below: (Figure 39)

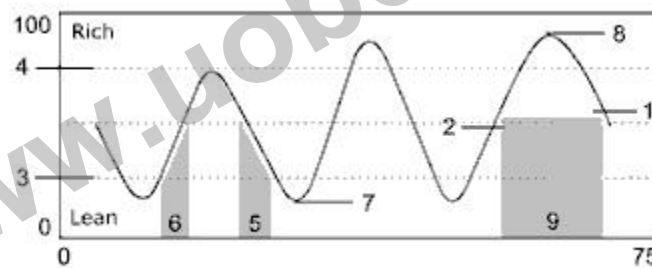
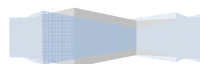



Figure 39

<u>Indicator</u>	<u>Descriptions</u>	<u>Units</u>
1.	Rich to Lean Threshold :	Volts
2.	Lean to Rich Threshold:	Volts
3.	Low Volt Switch Time Calc:	Sec
4.	High Volt Switch Time Calc:	Sec
5.	Rich to Lean Switch Time:	Sec
6.	Lean to Rich Switch Time:	Sec
7.	Test Cycle Volt - Min.:	Volts
8.	Test Cycle Volt - Max.:	Volts
9.	Time Between Transition:	Sec



To enter into the O2 sensor test function, go to the main menu (Figure 13).

Press  key until "O2 SENSOR TEST" (Figure 40).

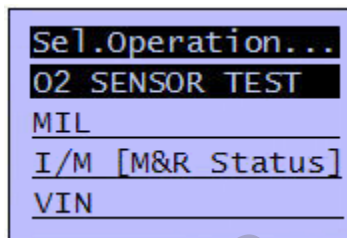



Figure 40

Press  key will display the menu as shown (Figure 41).  
Select the oxygen sensor to be tested and press  key.

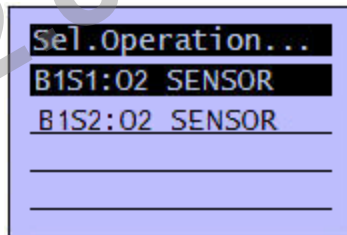



Figure 41

The screens will display the oxygen sensor data as shown in the examples below:

Note: Press  or  key to scroll up or down for more displays.

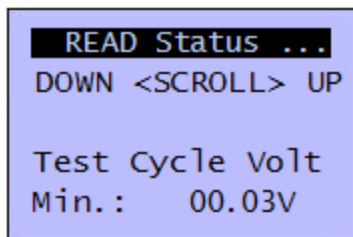

Figure 42

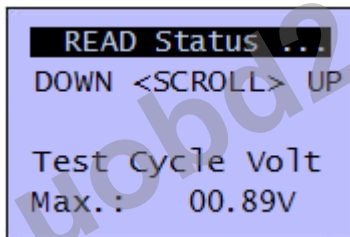

Figure 43

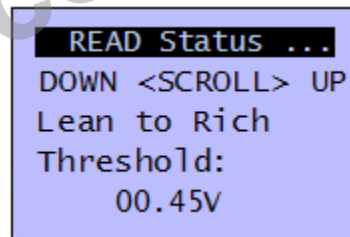

Figure 44

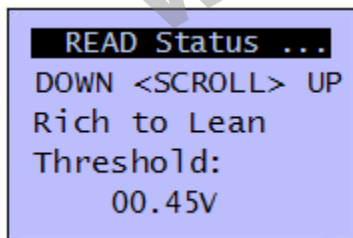

Figure 45

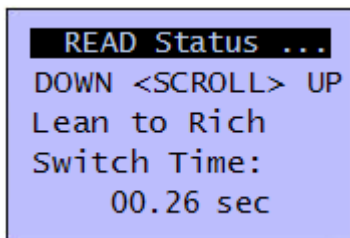

Figure 46

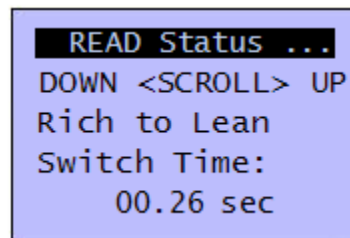

Figure 47

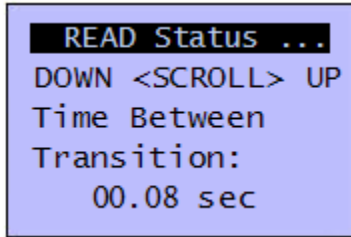

Figure 48

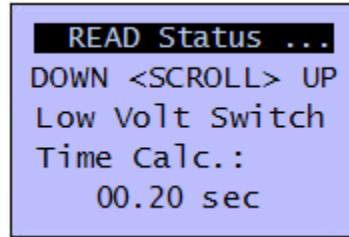

Figure 49

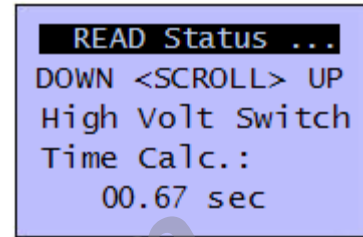

Figure 50

Note:

There are car models that do not support this function; therefore the display will show as below (Figure 51).

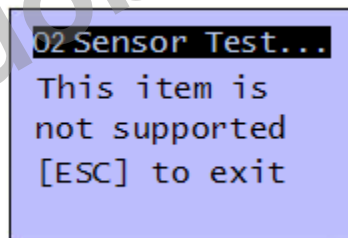

Figure 51

### **3.9 – Vehicle Information (VIN)**

This **Vehicle Information (VIN)** function allows the Scan Tool to request the vehicle's VIN number, calibration ID(s) which identifies software version in vehicle control module(s).

- ✓ **Vehicle Information (VIN)** function applies to model year 2000 and newer OBD II compliant vehicles.
- ✓ The Scan Tool cannot verify if data is incorrect for the scanned vehicles.

To access to this function, go back to the main Menu (Figure 13), press



key until "VIN" is found.  
(Figure 52)

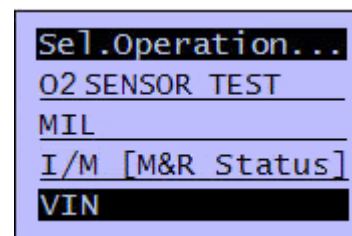



Figure 52

Press  key, the display will show the Vehicle Info: (Figure 53)

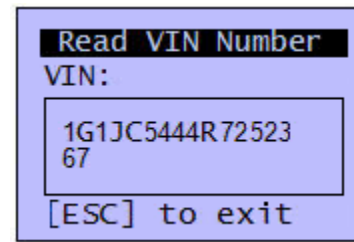

Figure 53

## 4.0 - Appendix

### 4.1 - Appendix A – PID Definitions

#### Global PID Definitions

All global parameter identification data (PID) listed was verified on actual vehicles to guarantee accuracy. PID definitions were obtained from reliable sources and are accurate at time of printing. It is possible that some newer vehicles may contain data different from what is listed. Always refer to vehicle service manual for manufacturer specific PIDs.

Remember; always refer the applicable service manual for detailed diagnostic procedures when troubleshooting PID values.

#### Types of Data Parameters

**INPUT:** These data parameters are obtained from sensor circuit outputs. Sensor circuit outputs are inputs to the vehicles PCM. For example, if oxygen sensor circuit was generating a 400mV signal, then the code reader would read O<sub>2</sub>S (v).40.

**OUTPUT:** These data parameters are outputs or commands that come directly from control module(s). For example, the ignition spark advance is controlled by PCM, on most vehicles, monitoring this PID shows spark output from PCM.

**CALCULATED VALUE:** These data parameters are calculated after analyzing various inputs to the vehicles control module(s). For example, the engine load. The PCM calculates this from sensor inputs and displays in a percentage.

**PCM VALUE:** Information that is stored in the control module(s) memory and determined to be useful to service technician. An example of this is TROUBLE CODE values (DTC) that caused Freeze Frame to be captured.

**NOTE:** Several different causes can have the same parameter indication. For information on diagnostics, please consult applicable Service Manuals. The Scan Tool **only** displays the PID's the vehicle supports.



**PID Definitions**

**Global Data Parameter List:**

**ABS FRP**

Absolute Fuel Rail Pressure

**ABS LOAD**

Absolute Load Value

**ABSLT TPS**

Absolute Throttle Position

**ACC POS x**

Accelerator Position x

**BARO PRS**

Barometric Pressure

**CALC LOAD**

Calculated Engine Load

**CAT TEMP xy**

Catalytic Converter Temperature  
Bank x, Sensor y

**CLR DST**

Distance Since Codes Cleared

**CLR TIM**

Time Since Clear Code

**CMD EQ RAT**

Commanded Equivalence Ratio

**COOLANT**

Engine Coolant

**EGR CMD**

Commanded Exhaust Gas  
Recirculation

**EGR ERR**

Exhaust Gas Recirculation Error

**ENG RUN**

Engine Run Time

**ENGINE**

Engine Speed

**EQ RAT**

Oxygen Sensor Equivalence Ratio

**EVAP REQ**

Commanded Evaporative Emission  
System Purge (0-100%)

**EVAP VP**

Evaporative Emission System Vapor  
Pressure

**FUEL LVL**

Fuel Level

**FUEL PRES**

Fuel System Pressure

**FUEL SYS x**

Fuel System x Loop Status

**IAT**

Intake Air Temperature

**IGN ADV**

Ignition Advance

**LT FTRM x**

Bank x Long Term Air To Fuel Ratio  
Correction Factor

**MAF**

Mass Air Flow Sensor

**MAP**

Manifold Absolute Pressure

**MIL DIST**

Distance Since Malfunction Indicator  
Lamp Came On

**MIL STATUS**

Malfunction Indicator Lamp Light  
Status

**MIL TIM**

Distance Travelled Or Time Since  
Malfunction Indicator Lamp Was  
Activated

**O2S**

O2 Sensor Output

**OBD2 STAT**

On Board Diagnostics 2 System  
Type

**OUTSID AIR**

Outside Air Temperature

**PTO STATUS**

Power Take Off Status

**REL FRP**

Relative Fuel Rail Pressure or  
Vacuum

**REL TPS**

Relative Or Learned Throttle Position

**SECOND AIR**

Secondary Air Pump Status

**ST FTRM**

Short Term Fuel Trim

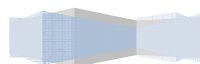



**ST FTRM x**  
Short Term Fuel Trim Bank x  
**THR POS x**  
Throttle Position x  
**THROT CMD**  
Throttle Actuator Commanded  
**TRIPS SNC CLR**  
Warmups Since Erase Codes

**TROUB CODE**  
Diagnostic Trouble Code That Set  
Freeze Frame  
**VEH SPEED**  
Vehicle Speed  
**VPWR**  
Vehicle Power

## **4.2 - Appendix B – Glossary**

---

**A/C:**  
Air Conditioner

**A/D:**  
Analog to Digital

**A/F:**  
Air/Fuel ratio. The proportion of air and fuel delivered to the cylinder for combustion. For example, an A/F ratio of 14:1 denotes 14 times as much air as fuel in the mixture. Ideally the A/F ratio is 14.7:1.

**ABS:**  
Anti-lock Brake System

**A/C Clutch Relay:**  
The PCM uses this relay to energize the A/C clutch, turning the A/C compressor ON or OFF.

**A/C Pressure Sensor:**  
Measures air conditioning refrigerant pressure and sends a voltage signal to the PCM.

**A/C Pressure Switch:**  
A mechanical switch connected to the A/C refrigerant line. The switch is activated (sending a signal to the PCM) when the A/C refrigerant pressure becomes too low or high.

**Actuator:**  
Actuators such as relays, solenoids, and motors allow the PCM to control the operation of vehicle systems.

**Air Injection Reaction (AIR) System:**  
An emission control system operated by the PCM. During cold starts, an air pump injects outside air into the exhaust manifold to help burn hot exhaust gases. This reduces pollution and speeds warm-up of oxygen sensors and catalytic converters. After the engine is warm, the air will either be dumped back to the atmosphere (or into the air cleaner assembly) or sent to the catalytic converter.

**APP:**

Acceleration Pedal Position (Sensor)

**ASR:**

Acceleration Slip Regulation

**AFC:**

Air Flow Control

**ALDL:**

Assembly Line Diagnostic Link. Former name for GM's (only) Data Link Connector, the connector socket into which the scan tool plug is inserted; sometimes used to refer to any pre-OBD II computer signals

**Bank x:**

The standard way of referring to the bank of cylinders containing cylinder #x. In-line engines have only one bank of cylinders. Most commonly used to identify the location of oxygen sensors. See **O<sub>2</sub>S**, **Sensor x**, **Sensor x**.

**BARO:**

Barometric Pressure Sensor. See **MAP Sensor**.

**BBV:**

Brake Boost Vacuum Sensor

**BCM:**

Body Control Module

**Boost Control Solenoid:**

A solenoid that is energized by the PCM, in order to control turbo/supercharger boost pressure.

**Brake Switch Signal:**

An input signal to the PCM indicating that the brake pedal is being pressed. This signal is typically used to disengage Cruise Control systems and Torque Converter Clutch (TCC) solenoids. See also **TCC**.

**CAM:**

Camshaft Position Sensor. Sends a frequency signal to the PCM in order to synchronize fuel injector and spark plug firing.

**Catalytic Converter:**

Designed to reduce exhaust emissions.

**CAN:**

Controller Area Network

**CARB:**

California Air Resources Board. Governing body for emissions control in California.

**CFI:**

Central Fuel Injection (a.k.a. Throttle Body Fuel Injection TBI)

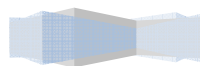

**CFI:**  
Continuous Fuel Injection

**CKP REF:**  
Crankshaft Position Reference.

**CKP:**  
Crankshaft Position. See **CPS**.

**CKT:**  
Circuit

**Closed Loop (CL):**  
A feedback system that uses the O<sub>2</sub> Sensor(s) to monitor the results of combustion. Based on the signal(s) from the O<sub>2</sub> sensor(s), the PCM modifies the air/fuel mixture to maintain optimum performance with lowest emissions. In closed loop mode, the PCM can fine tune control of a system to achieve an exact result.

**CMP:**  
Camshaft Position Sensor

**CO:**  
Carbon Monoxide; an odorless gas produced by incomplete combustion.

**Code Scanner:**  
A device that interfaces with and communicates information via a data link.

**Continuous Memory Codes:** See **Pending Codes**.

**CPS:**  
Crankshaft Position Sensor. Sends a frequency signal to the PCM. It is used to as reference for fuel injector operation and synchronizes spark plug firing on distributorless ignition systems (DIS).

**CTS:**  
Coolant Temperature Sensor. A resistance sensor that sends a voltage signal to the PCM indicating the temperature of the coolant. This signal tells the PCM whether the engine is cold or warm.

**CVRTD:**  
Continuous Variable Real Time Damping

**D/R:**  
Drive/Reverse

**Data Link Connector (DLC):**  
Connector providing access and/or control of the vehicle information, operating conditions, and diagnostic information. Vehicles with OBD II use a 16-pin connector located in the passenger compartment.

**Data Stream:**  
The actual (live) data communications sent from the vehicle's PCM to the data connector (DLC).

**DEPS:**  
Digital Engine Position Sensor.

**Detonation:** See **Knock**.

**DI/DIS:**  
Direct Ignition/Distributorless Ignition System. A system that produces the ignition spark without the use of a distributor.

**DPFE:**  
Differential Pressure Feedback – Exhaust Gas Recirculation Sensor

**Driving Cycle** - A specific sequence of start-up, warm-up and driving tasks that tests all OBD II functions

**DTC:**  
Diagnostic Trouble Code. An alphanumeric identifier for a fault condition identified by the On Board Diagnostic System.

**Duty Cycle:**  
A term applied to signals that switch between ON and OFF. Duty cycle is the percentage of time the signal is ON. For example, if the signal is ON only one fourth of the time, then the duty cycle is 25%. The PCM uses duty cycle type signals to maintain precise control of an actuator.

**EBCM:**  
Electronic Brake Control Module

**EBTCM:**  
Electronic Brake/Traction Control Module

**ECM**  
Engine Control Module or Electronic Control Module

**ECT:**  
Engine Coolant Temperature sensor. See **CTS**.

**EEPROM or E<sup>2</sup>PROM**  
Electrically Erasable Programmable Read Only Memory

**EFE:**  
Early Fuel Evaporation

**EFI:**  
Electronic Fuel Injection. Any system where a computer controls fuel delivery to the engine by using fuel injectors.

**EGR:**  
Exhaust Gas Recirculation. The PCM uses the EGR system to re-circulate exhaust gases back into the intake manifold to reduce emissions. EGR is used only during warm engine cruise conditions.

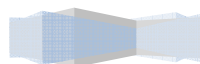

**EMR:**  
Electronic Module Retard

**EOP:**  
Engine Oil Pressure (Switch)

**EOT**  
Engine Oil Temperature (Sensor)

**EPA:**  
Environmental Protection Agency.

**ESC:**  
Electronic Spark Control. An ignition system function that warns the PCM when knock is detected. The PCM then retards spark timing to eliminate the knocking condition.

**EST:**  
Electronic Spark Timing. An ignition system that allows the PCM to control spark advance timing. The PCM determines optimum spark timing from sensors information — engine speed, throttle position, coolant temperature, engine load, vehicle speed, Park/Neutral switch position, and knock sensor condition.

**EVAP:**  
Evaporative Emissions System.

**FC:**  
Fan Control

**Freeze Frame:**  
A block of memory containing DTCs of the vehicle operating conditions for a specific time.

**FTP:**  
Federal Test Procedure. Strict test of vehicle's emissions.

**Fuel Trim:**  
Engine computer function that keeps the air/fuel mixture as close to the ideal 14.7:1 stoichiometric ratio as possible.

**Ground (GND):**  
An electrical conductor used as a common return for an electric circuit(s) and with a relative zero potential (voltage).

**Hall Effect Sensor:**  
Any of a type of sensor utilizing a permanent magnet and a transistorized Hall Effect switch. Hall Effect type sensors may be used to measure speed and position of the crankshaft or camshaft — for spark timing and fuel injector control.

**HC:**  
Hydrocarbons

**HEI:**

High Energy Ignition

**HO<sub>2</sub>S:**

Heated Oxygen Sensor. See **O<sub>2</sub>S**.

**HVAC:**

Heating, Ventilation & Air Conditioning (System)

**I/M:**

Inspection and Maintenance. An emission control program.

**IAC:**

Idle Air Control. A device mounted on the throttle body which adjusts the amount of air bypassing a closed throttle so that the PCM can control idle speed.

**IAT:**

Intake Air Temperature (Sensor)

**ICM:**

Ignition Control Module.

**IMRC:**

Intake Manifold Runner Control

**IPC:**

Instrument Panel Cluster

**ISC:**

Idle Speed Control. A small electric motor mounted on the throttle body and controlled by the PCM. The PCM can control idle speed by commanding the ISC to adjust its position.

**ISO:**

International Organization of Standardization also known as International Standards Organization.

**ISO 9141:**

International Standards Organization OBDII communication protocol, used by Chrysler and most foreign cars. One of three hardware layers defined by OBD II

**J1850 PWM:**

(Pulse Width Modulation) SAE-established OBD II communication protocol used by Ford domestic cars and light trucks. One of three hardware layers defined by OBD II

**J1850 VPW:**

(Variable Pulse Width Modulation) SAE-established OBD II communication protocol used by GM cars and light trucks. One of three hardware layers defined by OBD II

**J1962 – SAE:**

Established standard for the connector plug layout used for all OBD II scan tools

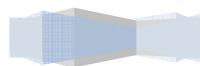

**J1978 – SAE:**

Established standard for OBD II scan tools

**J1979 – SAE:**

Established standard for diagnostic test modes

**J2012 – SAE:**

Established standard accepted by EPA as the standard test report language for emission tests

**KAM:**

Keep Alive Memory

**Knock Sensor (KS):**

Used to detect engine detonation or knock. The sensor contains a piezoelectric element and is threaded into the engine block. Special construction makes the element sensitive only to engine vibrations associated with detonation.

**Knock:**

Uncontrolled ignition of the air/fuel mixture in the cylinder. Also referred to as detonation or ping. Knock indicates extreme cylinder pressures or “hotspots” which are causing the air/fuel mixture to detonate prematurely.

**KOEO:**

Key On Engine Off. Turn the ignition key to on, but do not start engine.

**KOER:**

Key On Engine Running. Start engine and keep it running.

**LCD:**

Liquid Crystal Display

**LTFT:**

Long Term Fuel Trim

**M/T:**

Manual transmission or manual transaxle.

**MAF:**

Mass Air Flow (sensor). Measures the amount and density of air entering the engine and sends a frequency or voltage signal to the PCM. The PCM uses this signal in its fuel delivery calculations.

**MAP:**

Manifold Absolute Pressure (sensor). Measures intake manifold vacuum or pressure and sends a frequency or voltage signal (depending on sensor type) to the PCM. This gives the PCM information on engine load for control of fuel delivery, spark advance, and EGR flow.

**MAT:**

Manifold Air Temperature (sensor). A resistance sensor in the intake manifold that sends a voltage signal to the PCM indicating the temperature of the incoming air. The PCM uses this signal for fuel delivery calculations.



**MIL:**

Malfunction Indicator Lamp. The MIL is most commonly known as the Check Engine or Service Engine Soon light. A required on-board indicator to alert the driver of an emission-related malfunction.

**Misfire:**

Caused by the air/fuel ratio being incorrect.

**Monitor:**

A test performed by the on-board computer to verify proper operation of emission-related systems or components.

**MPFI or MFI:**

Multi-Port Fuel Injection. MPFI is a fuel injection system using one (or more) injector(s) for each cylinder. The injectors are mounted in the intake manifold, and fired in groups rather than individually.

**NOx:**

Oxides of Nitrogen. The system EGR and Camshafts injects exhaust gases into the intake manifold to reduce these gases at the tailpipe.

**O<sub>2</sub>S:**

Oxygen Sensor. Generates a voltage of 0.6 to 1.1 volts when the exhaust gas is rich (low oxygen content). The voltage changes to 0.4 volts or less when the exhaust gas is lean (high oxygen content). This sensor only operates after it reaches a temperature of approximately 349°C (660°F). O<sub>2</sub> sensors are usually found both upstream and downstream of the catalytic converter. The PCM uses these sensors to fine tune the air-fuel ratio and to monitor the efficiency of the catalytic converter. See **Bank 1, Bank 2, Sensor 1, Sensor 2**.

**OBD II:**

On-Board Diagnostics, Second Generation. OBD II is a U.S. Government mandated standard requiring all cars and light trucks to have a common data connector, connector location, communication protocol, DTCs and code definitions. OBD II first appeared on vehicles in late 1994, and is required to be present on all cars sold in the US after January 1, 1996.

**ODM:**

Output Device Monitor.

**Open Loop (OL):**

A control system mode that does not monitor the output to verify if the desired results were achieved. A fuel delivery system usually operates in open loop mode during cold engine warm-up because the oxygen sensors are not yet ready to send a signal. Without the oxygen sensor signal, the computer cannot check the actual results of combustion.

**PCM:**

Powertrain Control Module. The brains of the engine and transmission control systems housed in a metal box with a number of sensors and actuators connected via a wiring harness. Its job is to control fuel delivery, idle speed, spark advance timing, and emission systems. The PCM receives information from sensors, then energizes various actuators to control the engine. The PCM is also known as the ECM (Engine Control Module).

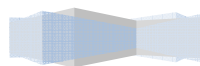

**PCV:**  
Positive Crankcase Ventilation

**Pending Codes:**  
Also referred to as Continuous Memory codes and Maturing Diagnostic Trouble Codes. Pending Codes may be set by emission related powertrain components and systems. If the fault does not occur after a certain number of drive cycles, the code is erased from memory.

**PID:**  
Parameter Identification. Identifies an address in memory which contains vehicle operating information.

**PNP:**  
Park/Neutral Position. A switch that tells the PCM when the gear shift lever is in the Park or Neutral position. When in Park or Neutral, the PCM operates the engine in an idle mode.

**PROM:**  
Programmable Read-Only Memory. The PROM contains programming information the PCM needs to operate a specific vehicle model/engine combination.

**Proprietary Readings:**  
Parameters shown by on-board computers which are not required by OBD II, but included by manufacturer to assist in trouble-shooting specific vehicles.

**PSPS:**  
Power Steering Pressure Switch

**Purge Solenoid:**  
Controls the flow of fuel vapors from the carbon canister to the intake manifold. The canister collects vapors evaporating from the fuel tank, preventing them from escaping to the atmosphere and causing pollution. During warm engine cruise conditions, the PCM energizes the Purge Solenoid so the trapped vapors are drawn into the engine and burned.

**PTC:**  
Pending Trouble Code

**PWM:**  
Pulse Width Modulation

**PZM:**  
Platform Zone Module

**QDM:**  
Quad Driver Module

**RAM:**  
Random Access Memory

**Relay:**  
An electromechanical device in which connections in one circuit are switched.

**Reluctance Sensor:**

A type of sensor typically used to measure crankshaft or camshaft speed and/or position, driveshaft speed, and wheel speed.

**ROM:**

Read-Only Memory. Permanent programming information stored inside the PCM, containing the information the PCM needs to operate a specific vehicle model/engine combination.

**RPM:**

Revolutions Per Minute

**SAE:**

Society of Automotive Engineers.

**Scan Tool:**

A device that interfaces with and communicates information on a data link.

**SDM:**

Sensing and Diagnostic Module

**Sensor x:**

A standard term used to identify the location of oxygen sensors. Sensor 1 is located upstream of the catalytic converter. See **O<sub>2</sub>S, Bank 1, Bank 2**.

**Sensor:**

Any device that reports information to the PCM. The job of the sensor is to convert a parameter such as engine temperature into an electrical signal that the PCM can understand.

**SES:**

Service Engine Soon dash light, now referred to as MIL

**SFI or SEFI:**

Sequential Fuel Injection or Sequential Electronic Fuel Injection. A fuel injection system that uses one or more injectors for each cylinder. The injectors are mounted in the intake manifold and are fired individually.

**Solenoid:**

A device consisting of an electrical coil which when energized, produces a magnetic field in a plunger, which is pulled to a central position. A solenoid may be used as an actuator in a valve or switch.

**STFT:**

Short Term Fuel Trim.

**STS:**

Service Throttle Soon

**TAC:**

Throttle Actuator Control

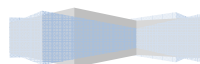

**TBI:**

Throttle Body Injection. A fuel injection system having one or more injectors mounted in a centrally located throttle body, as opposed to positioning the injectors close to an intake valve port. TBI is also called Central Fuel Injection (CFI) in some vehicles.

**TCC:**

Torque Converter Clutch

**TCM:**

Transmission Control Module

**TCS:**

Traction Control System for PCM and brakes

**TDC:**

Top Dead Center. When a piston is at its uppermost position in the cylinder.

**TFP:**

Transmission Fluid Pressure

**TFT:**

Transmission Fluid Temperature (Sensor)

**Throttle Body:**

A device which performs the same function as a carburetor in a fuel injection system. On a throttle body injection (TBI) system, the throttle body is both the air door and the location of the fuel injectors. On port fuel injection systems (PFI, MPFI, SFI, etc.), the throttle body is simply an air door. Fuel is not added until the injectors at each intake port are activated. In each case, the throttle body is attached to the accelerator pedal.

**TPS:**

Throttle Position Sensor. Potentiometer-type sensor connected to the throttle shaft. Its voltage signal output increases as the throttle is opened. The PCM uses this signal to control many systems such as idle speed, spark advance, fuel delivery, etc

**Traction Assist:**

Assist in traction with brakes only.

**Trip:**

Vehicle operation for a period of time so the systems can be monitored.

**TTS:**

Transmission Temperature Sensor. A resistance sensor mounted in the transmission housing in contact with the transmission fluid. It sends a voltage signal to the PCM indicating the temperature of the transmission.

**VECI:**

Vehicle Emission Control Information. A decal located in the engine compartment containing information about the emission control systems found on the vehicle. The VECI is the authoritative source for determining whether a vehicle is OBD II compliant.

**VIN:**

Vehicle Identification Number. This is the factory-assigned vehicle serial number. This number is stamped on a number of locations throughout the vehicle, but the most prominent location is on top of the dashboard on the driver's side, visible from outside the car. The VIN includes information about the car, including where it was built, body and engine codes, options, and a sequential build number.

**VSS:**

Vehicle Speed Sensor. Sends a frequency signal to the PCM. The frequency increases as the vehicle moves faster to give the PCM vehicle speed information used to determine shift points, engine load, and cruise control functions.

**VTD:**

Vehicle Theft Deterrent

**Warm-up Cycle:**

Warm-up cycle is when the engine coolant temperature rises at least 40 degrees above that at engine start up.

**WOT:**

Wide-Open Throttle. The vehicle operating condition brought about when the throttle is completely (or nearly) open. The PCM typically delivers extra fuel to the engine and de-energizes the A/C compressor at this time for acceleration purposes. The PCM uses a switch or the TPS to identify the WOT condition.

### **4.3 - Appendix C –Support Vehicle Models List (part)**

**Note:** Specific parameters supported are dependent on; year and make, engine, transmission, options, etc.

**A**

Acura 2.3CL	Audi A3
Acura 2.5TL	Audi A4
Acura 3.0CL	Audi A6
Acura 3.2CL	Audi A8
Acura 3.2TL	Audi A8L
Acura 3.5RL	Audi All road
Acura Integra	Audi Cabriolet
Acura MDX	Audi S4
Acura NSX	Audi S6
Acura RSX	Audi S8
Acura SLX	Audi TT
Acura TSX	

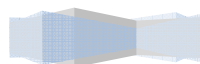

**B**

BMW 320i  
BMW 320iA  
BMW 323i  
BMW 323Ti  
BMW 325Ci  
BMW 325i  
BMW 330Ci  
BMW 330i  
BMW 530i  
BMW 545i  
BMW 745i  
BMW 745Li  
BMW 760Li

BMW M3  
BMW X3  
BMW X5  
BMW Z3  
BMW Z4

Buick Allure Buick LaCrosse  
Buick LeSabre  
Buick Park Avenue  
Buick Rainier  
Buick Rendezvous 3.6  
Buick Terraza

**C**

Cadillac Catera  
Cadillac CTS  
Cadillac DeVille  
Cadillac DHS  
Cadillac DTS  
Cadillac Seville  
Cadillac STS  
Cadillac XLR

Chevrolet Astro, AWD  
Chevrolet Avalanche  
Chevrolet Aveo  
Chevrolet B7-Chassis  
Chevrolet Blazer, 2WD, 4WD  
Chevrolet C-Series  
Chevrolet C1500, 2WD  
Chevrolet C2500 2WD, 08600  
Chevrolet C3500, 2WD  
Chevrolet Camaro  
Chevrolet Cavalier  
Chevrolet Prizm  
Chevrolet S-10 2WD  
Chevrolet S10  
Chevrolet Silv O8600 GVW  
Chevrolet Silv. 2500 HD  
Chevrolet Silv. 3500 2WD  
Chevrolet Silverado  
Chevrolet SSR  
Chevrolet Suburban  
Chevrolet Tahoe

Chevrolet Cobalt 2.0L, 2.2L  
Chevrolet Colorado  
Chevrolet Corvette  
Chevrolet Equinox  
Chevrolet Express, Acces  
Chevrolet G2500 Van  
Chevrolet Impala  
Chevrolet K1500  
Chevrolet K2500 O8600  
Chevrolet K3500  
Chevrolet Lumina  
Chevrolet Malibu  
Chevrolet MD B7-Chassis  
Chevrolet MD C-Series  
Chevrolet MD T-Series  
Chevrolet MD W4 Series  
Chevrolet MD WT5500  
Chevrolet Medium Duty  
Chevrolet Metro  
Chevrolet Monte Carlo

Chevrolet Tracker  
Chevrolet Trailblazer  
Chevrolet Uplander  
Chevrolet Venture  
Chevrolet W4 Series  
Chevrolet WT5500

Chrysler 300 Tour. AWD  
Chrysler 300 Touring  
Chrysler 300M

Chrysler Cirrus  
Chrysler Concorde  
Chrysler Crossfire  
Chrysler Intrepid  
Chrysler LHS

Chrysler Neon  
Chrysler Pacifica, AWD  
Chrysler Sebring Convertible, Coupe, Sedan  
Chrysler Town & Country  
Chrysler Voyager

**D**

Daewoo Lanos  
Daewoo Leganza  
Daewoo Nubira

Dodge Avenger  
Dodge Caravan  
Dodge  
Colt  
Dodge Dakota 4X2, 4X4  
Dodge Durango 4X2, 4X4  
Dodge Grand Caravan  
Dodge Intrepid  
Dodge Magnum,

Dodge Neon, AWD  
Dodge Ram 1500 4X2, 4X4  
Dodge Ram 2500 4X2, 4X4  
Dodge Ram 3500 4X2, 4X4  
Dodge Ram SRT-10  
Dodge Ram Van 1500, 2500, 3500  
Dodge Ram Wagon 1500, 2500, 3500  
Dodge Sprinter  
Dodge SRT-4  
Dodge Stealth  
Dodge Stratus, Coupe, Sedan  
Dodge Viper

**E**

Eagle Summit

Eagle Talon

**F**

Ford Aspire  
Ford Club Wagon  
Ford Contour  
Ford Crown Victoria  
Ford E-Super Duty  
Ford Econoline, E150, E250  
Ford Econoline E350, E450  
Ford Escape  
Ford Escort  
Ford Excursion  
Ford Exp Sport Trac  
Ford Expedition  
Ford Explorer, Sport, Postal  
Ford F-150, Heritage, Reg. Cab  
Ford F-150 Super Cab  
Ford F-250, Reg. Cab,  
Ford F-250 Super Cab

Ford Five Hundred  
Ford Focus  
Ford GT  
Ford Freestar  
Ford Freestyle  
Ford Motorhome  
Ford Mustang  
Ford Ranger  
Ford Super Club  
Ford Super Van  
Ford Super Duty  
Ford Taurus  
Ford Thunderbird  
Ford Windstar  
Ford ZX2

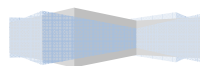



**G**

Geo Metro  
Geo Prizm  
Geo Tracker

GM of Canada Firefly  
GMC C-Series  
GMC C1500  
GMC C2500 O8600  
GMC C3500  
GMC Canyon  
GMC Envoy, XL, XUV  
GMC Jimmy, 2WD, 4WD  
GMC Jimmy 4X2, 4x4  
GMC K1500, 4WD  
GMC K2500 O8600  
GMC K2500 U8600  
GMC K3500, 4WD  
GMC MD B7-Chassis  
GMC MD C-Series  
GMC MD T-Series  
GMC MD W4 Series  
GMC MD WT5500  
GMC Medium Duty

GMC P35 Comm  
GMC Safari, AWD, RWD  
GMC Savanna  
GMC Sierra  
GMC Sierra 2500 HD, 2WD  
GMC Sierra 3500 HD, 4WD  
GMC Sierra C3 AWD  
GMC Sierra Denali  
GMC Sierra PHT  
GMC Sonoma, 3WD, 4WD  
GMC Suburban 2WD, 4WD  
GMC Suburban O8600  
GMC Suburban U8600  
GMC T-Series  
GMC W4 Series  
GMC WT5500  
GMC Yukon, 2WD, 4WD  
GMC Yukon Denali  
GMC Yukon XL  
GMC Yukon XL 2WD  
GMC Yukon XL 4WD  
GMC Yukon XL Denali

**H**

Honda Accord  
Honda Civic  
Honda CR-V  
Honda Element  
Honda Insight  
Honda Odyssey  
Honda Passport 2WD  
Honda Passport 4WD  
Honda Pilot  
Honda Prelude  
Honda S2000

Hummer H2  
Hyundai Accent  
Hyundai Elantra  
Hyundai Elantra Wagon  
Hyundai Santa Fe  
Hyundai Sonata  
Hyundai Tiburon  
Hyundai Tuscon  
Hyundai XG300  
Hyundai XG350

**I**

Infiniti FX35  
Infiniti FX45  
Infiniti G20  
Infiniti G20t  
Infiniti G35  
Infiniti I30  
Infiniti I30t

Infiniti I35  
Infiniti M45  
Infiniti Q45  
Infiniti Q45t  
Infiniti QX4  
Infiniti QX56

Isuzu Amigo  
Isuzu Ascender  
Isuzu Axiom

Isuzu Hombre  
Isuzu Oasis

**J**

Jaguar S-Type  
Jaguar X-Type  
Jaguar XJ  
Jaguar XK

Jeep Cherokee  
Jeep Grand Cherokee  
Jeep Liberty  
Jeep Liberty 4x2, 4X4  
Jeep Wrangler

**K**

Kia Amanti  
Kia Optima  
Kia Rio  
Kia Rio Cinco  
Kia Sedona

Kia Sephia  
Kia Sorento  
Kia Spectra  
Kia Sportage

**L**

Land Rover Discovery  
Land Rover Freelander  
Land Rover Range Rover 75

Lexus LS400  
Lexus LX 470  
Lexus LX450  
Lexus LX470  
Lexus RX 300  
Lexus SC 430  
Lexus SC300  
Lexus SC400

Lexus ES 300  
Lexus ES 330  
Lexus ES300  
Lexus GS 300  
Lexus GS 430  
Lexus GS300  
Lexus GS400  
Lexus GX 470  
Lexus GX 470  
Lexus IS 300  
Lexus LS 430

Lincoln Aviator  
Lincoln Blackwood  
Lincoln Continental  
Lincoln LS  
Lincoln Navigator  
Lincoln Town Car

**M**

Mazda 626  
Mazda B-2300  
Mazda B-2500  
Mazda B-3000  
Mazda B-4000  
Mazda Mazda3  
Mazda Mazda6  
Mazda Miata  
Mazda Miata

Mazda Spd  
Mazda Miata MX-5  
Mazda Millenia  
Mazda MPV  
Mazda Protege  
Mazda Tribute

Mercedes Benz C200 K  
Mercedes Benz C200 KT

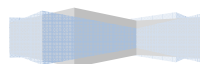

Mercedes Benz C240 (203)  
Mercedes Benz C32 AMG (203)  
Mercedes Benz C320 (203)  
Mercedes Benz C43 AMG (202)  
Mercedes Benz C55 AMG  
Mercedes Benz CL200 K  
Mercedes Benz CL230 K  
Mercedes Benz CL500 (140)  
Mercedes Benz CL500 (215)  
Mercedes Benz CL55 AMG (215)  
Mercedes Benz CL600 (140)  
Mercedes Benz CL600 (215)  
Mercedes Benz CL600 (215)  
Mercedes Benz CLK320 (208)  
Mercedes Benz CLK430 (208)  
Mercedes Benz CLK500 (208)  
Mercedes Benz CLK55AMG (208)  
Mercedes Benz E320 (210)  
Mercedes Benz E430 (210)  
Mercedes Benz E500 (210)  
Mercedes Benz E55 AMG (210)  
Mercedes Benz G500 (463)  
Mercedes Benz G55 AMG (463)  
Mercedes Benz ML320 (163)  
Mercedes Benz ML350 (163)  
Mercedes Benz ML430 (163)  
Mercedes Benz ML500 (163)  
Mercedes Benz ML55 AMG (163)  
Mercedes Benz S430 (220)  
Mercedes Benz S500 (220)  
Mercedes Benz S500L  
Mercedes Benz S55 AMG (220)  
Mercedes Benz S600 (220)  
Mercedes Benz S600L

**N**

Nissan 350Z  
Nissan Altima  
Nissan Frontier  
Nissan Maxima  
Nissan Murano  
Nissan Armada

Mercedes Benz SL350  
Mercedes Benz SL500 (129)  
Mercedes Benz SL55 AMG (129)  
Mercedes Benz SL600 (129)  
Mercedes Benz SLK200K  
Mercedes Benz SLK230 (170)  
Mercedes Benz SLK320 (170)  
Mercedes Benz SLK320 AMG  
Mercedes Benz SLK320AMG (170)  
Mercedes Benz SLK350

Mercury Cougar  
Mercury Grand Marquis  
Mercury Marauder  
Mercury Mariner  
Mercury Montego  
Mercury Monterey  
Mercury Mountaineer  
Mercury Mystique  
Mercury Sable  
Mercury Villager

Mitsubishi 3000GT  
Mitsubishi 3000GT Spyder  
Mitsubishi Diamante  
Mitsubishi Eclipse  
Mitsubishi Eclipse Spyder  
Mitsubishi Endeavor  
Mitsubishi Gallant  
Mitsubishi Lancer  
Mitsubishi Mirage  
Mitsubishi Montero  
Mitsubishi Montero Sport  
Mitsubishi Outlander

Nissan Pathfinder  
Nissan Quest  
Nissan Sentra  
Nissan Titan  
Nissan Xterra

**O**

Oldsmobile Alero  
Oldsmobile Aurora  
Oldsmobile Bravada

Oldsmobile Cutlass  
Oldsmobile Eighty Eight  
Oldsmobile Intrigue  
Oldsmobile LSS

**P**

Pontiac Aztek  
Pontiac Bonneville  
Pontiac Firebird  
Pontiac G6  
Pontiac Grand Am  
Pontiac Grand Prix  
Pontiac GTO  
Pontiac Montana  
Pontiac Montana SV6  
Pontiac Pursuit  
Pontiac Sunfire  
Pontiac Vibe  
Pontiac Vibe 1.8L LV6

Porsche 911  
Porsche 911 Carrera  
Porsche Boxster  
Porsche Cayenne  
Plymouth Breeze  
Plymouth Colt  
Plymouth Grand Voyager  
Plymouth Neon  
Plymouth Prowler  
Plymouth Voyager

**S**

Saab 9-3  
Saab 9-5  
  
Saturn Ion, 2.0L, 2.2L  
Saturn LS, LW  
Saturn Relay  
Saturn SC1, SC2  
Saturn SL, SC, SW  
Saturn SL1, SL2  
Saturn SW1, SW2  
Saturn VUE

Subaru Forester  
Subaru Impreza  
Subaru Legacy  
Subaru Outback  
Subaru SVX

Scion TC  
Scion XA  
Scion XB

Suzuki Aerio  
Suzuki Esteem  
Suzuki Forenza  
Suzuki Grand Vitara  
Suzuki Sidekick  
Suzuki Swift  
Suzuki Verona  
Suzuki Vitara  
Suzuki X-90  
Suzuki XL-7

Subaru Baja

**T**

Toyota 4-Runner  
Toyota Avalon  
Toyota Camry  
Toyota Camry Solara  
Toyota Celica

Toyota Corolla  
Toyota Echo  
Toyota Highlander  
Toyota Land Cruiser  
Toyota Matrix

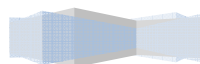

Toyota MR2  
Toyota MR2 Spider  
Toyota Paseo  
Toyota Previa  
Toyota Rav4  
Toyota Sequoia

Toyota Sienna  
Toyota T-100  
Toyota Tacoma  
Toyota Tercel  
Toyota Tundra

**V**

Volkswagen Beetle  
Volkswagen Bora  
Volkswagen Eurovan L5  
Volkswagen Eurovan VR6  
Volkswagen Golf A3  
Volkswagen Golf A4  
Volkswagen GTI  
Volkswagen Jetta A3  
Volkswagen Jetta A4  
Volkswagen Passat

Volkswagen Touareg  
Volvo C70  
Volvo S40  
Volvo S60  
Volvo S80  
Volvo V40  
Volvo V70  
Volvo XC70  
Volvo XC90

- Supports ISO, VPW and PWM bus systems as well as CAN bus systems
- U.S. Models - European - Japanese - Asian - German - Korean:
- Suitable for almost all cars after 1996 .
- GM '96 - Current Year (OBD-II / EOBD)
- Ford '96 - Current Year (OBD-II / EOBD)
- Chrysler '96 - Current Year (OBD-II / EOBD)
- Toyota '96 - Current Year (OBD-II / EOBD)
- Honda '96 - Current Year (OBD-II / EOBD)
- NISSAN '96 - Current Year (OBD-II / EOBD)
- All other - Asian and European '96 - Current Year (OBD-II / EOBD)

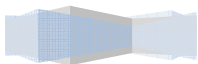

## 4.4 - Appendix D –What is EOBD, EOBD2 and OBD-II

### What is EOBD?

EOBD is an abbreviation of **E**uropean **O**n-**B**oard **D**iagnostics.

All petrol cars sold within Europe since 1 Jan 2001, and diesel cars manufactured from 2003, must have on-board diagnostic systems to monitor engine emissions.

These systems were introduced in line with **European Directive 98/69/EC** to monitor and reduce emissions from cars.

All such cars must also have a standard EOBD diagnostic socket that provides access to this system (as shown below).

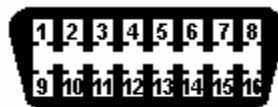

### The EOBD / OBDII 16-pin diagnostic connector (DLC)

#### Where is the connector?

The EOBD connector is required by the Directive to be located within the passenger compartment of the car, within reach of the driver's seat. Tools should not be required to reveal the connector, but it may have a removable cover over it.

#### What does the connector look like?

The connector has the following shape:

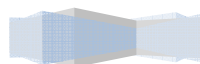
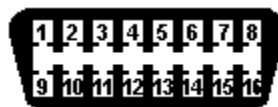

## Which pins contacts should be present on the connector?

Different pins on the connector are used by different manufacturers. There are 5 pin out combinations within the standard, each of which uses a specific communications protocol. These are listed below:

Protocol	Connector pins used
J1850 VPW	2, 4, 5, and 16, but not 10
ISO 9141-2	4, 5, 7, 15 (see below) and 16
J1850 PWM	2, 4, 5, 10 and 16
KWP2000 (ISO 14230)	4, 5, 7, 15 (see below) and 16
CAN (Controller Area Network)	4, 5, 6, 14 and 16

**Note:** For ISO/KWP2000 communications, **pin 15** (L-line) is not always required. Pin 15 was used on earlier ISO/KWP2000 cars to "wake-up" the ECU before communication could begin on pin 7 (K-Line). Later cars tend to communicate using only pin 7 (K-Line).

**Rover and MG cars:** We have noticed that many Rover and MG models do not have pin 5 (Signal Ground). This can prevent some diagnostic tools from 'powering up' where they use pin 5 as the ground for the circuitry.

## What are each of the pins used for?

The pins are used as follows:

Pin	Use
2	J1850 Bus+
4	Chassis Ground
5	Signal Ground
6	CAN High (J-2284)
7	ISO 9141-2 K Line and ISO/DIS 14230-4
10	J1850 Bus
14	CAN Low (J-2284)
15	ISO 9141-2 L Line and ISO/DIS 14230-4
16	Battery power (+)



Additional pins may be wired on your car - these may be used by the vehicle Manufacturer for other purposes.

### Which protocol is used by each manufacturer?

As a rough guide, the protocols are generally found on cars from the following manufacturers:

Protocol	Manufacturers
<b>J1850 VPW</b>	General Motors, Chrysler...
<b>J1850 PWM</b>	Ford models to 2003 with EEC-V engine management system, this includes: Ford <b>Cougar</b> (all UK models), Ford <b>Puma</b> (1.6 and 1.7), Ford <b>Fiesta</b> Zetec models to 2003, Ford <b>Mondeo</b> Zetec models to 2003, Ford <b>Focus</b> to 2003 (and some of the newer Ford-based <b>Jaguars</b> , e.g. S-Type)...
<b>ISO 9141 &amp; KWP 2000</b>	Most European and Asian manufacturers, e.g. Alfa Romeo, Audi, BMW, Citroen, Fiat, Honda, Hyundai, Jaguar (X300, XK series and X-Type), Jeep, Kia, Land Rover, Mazda, Mercedes, Mitsubishi, Nissan, Peugeot, Renault, Saab, Skoda, Subaru, Toyota, Vauxhall, Volkswagen (VW), Volvo ...
<b>CAN</b>	Ford 2004+ Fiesta, Fusion, Mondeo, Focus models Mazda RX-8... Vauxhall Vectra 2003+ model  Most new models from approx. 2004 - CAN must be used for EOBD engine diagnostics by all manufacturers by 2008...

Only the latest scan tools and code readers can be relied upon to read the diagnostic information through the EOBD socket.

### 'Check Engine' light



The 'Check Engine' warning light on the dashboard is often the first sign that the car owner knows about a problem with his car.

This provides very little information to the owner, or to the technician when asked to investigate the problem.

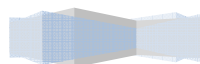

## Problem diagnosis

With the modern tools, skilled technicians should be able to diagnose and solve many of the problems, which prior to this, required the sophisticated console tools of main dealers.

## New technology

The introduction of European on-board diagnostics standards has opened up new opportunities for car workshops and owners.

A range of low-cost tools are now available to read and clear error codes, to view live/stored readings from sensors within the car, and to switch off the 'Check Engine' light.

## What information is available?

EOBD systems monitor and store information from sensors throughout the car, e.g. air flow sensors, oxygen sensors, etc.

Sensor values outside an acceptable range will trigger a Diagnostic Trouble Code (DTC). The Scan tools can display and interpret these codes. Some Scan Tools will also provide 'Live Data' of the sensors output.

## EOBD or OBD II?

On-Board Diagnostics, or OBD, was the name given to the early emission control and engine-management systems introduced in cars. There is no single OBD standard and each manufacturer, often using quite different systems (even between individual car models).

OBD systems have been developed and enhanced, in line with United States government requirements, into the current OBD II standard.

The OBD II Federal requirements apply to cars sold in the United States from 1996.

EOBD is the European equivalent of the American OBD II standard, which applies to petrol cars sold in Europe from 2001 (and for diesel cars 3 years later).

## Why do OBDII and EOBD tools not work on all cars from 1996 in the UK and Europe?

- 59 -

Some of our most frequently asked questions on our OBDII and EOBD tools are:

"I have seen these/similar products advertised as working on all 1996 and newer cars - why don't yours?"

"I've just bought an OBDII/EOBD tool from someone else that was advertised as working with all 1996 and newer cars. Why doesn't it work on my [1999 Vauxhall Vectra]?"

Here is the answer...

In 1996 in the United States, a Federal Law came into force requiring **all US-sold cars** to be OBDII compliant. Most OBDII tools are therefore advertised as working with all cars from 1996.

The OBDII Federal Law applied **only to cars sold in the US**.

In the UK and the rest of Europe, the equivalent law (European On-Board Diagnostics, or EOBD) did not come into force, and more importantly, was not fully implemented by our car manufacturers, until 2001 for petrol cars (2003/4 for diesels).

Where an OBDII tool is sold in the UK/Europe claiming to work on all cars from 1996, this is highly **unlikely to be the case**.

Even where a seemingly identical car may have been sold in Europe and the US before 2001, from our own testing and research, it is rarely the case that the European model will be OBDII/EOBD compliant.

The fact that we sell these tools as only working with 2001 and newer petrol (and similarly 2003/4 diesels) is due to the fact that we are being honest in the coverage, rather than simply duplicating the sales information from the US.

**So do these tools work with any UK/European cars before 2001?**

Yes they do, but certainly not across the board, and very rarely back as far as 1996. A few manufacturers that we know have some OBDII/EOBD support (on petrol models) before 2001 are listed below:

Ford (most petrol cars using the EEC-V engine management system)  
Jaguar (most models from the beginning of the X300 series)  
Volvo (some models)

A few examples of manufacturers that we have had very little success connecting OBDII/EOBD tools on pre-2001 models are:

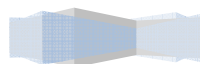

Vauxhall  
Peugeot  
Citroen  
Fiat

Please be aware that we do not try to sell these tools as something they are not.

### What is EOBD2?

EOBD2 is **not** a new version of EOBD.

Where EOBD stands for 'European On-Board Diagnostics', EOBD2 actually stands for 'Enhanced On-Board Diagnostics, Second Generation'.

EOBD2 tends to refer to manufacturer-specific features available on some OBDII/EOBD tools to access additional parameters/information from a car, over and above the normal parameters and information available within the EOBD/OBDII standard.

EOBD2 features are normally highly manufacturer-specific, and will usually only be available for a certain car manufacturer, e.g. Ford.

There are, as such, no 'EOBD2 cars', i.e. cars that require an EOBD2 tool to access their diagnostics information. EOBD2 functionality might however allow more information to be extracted from an EOBD/OBDII compliant car.

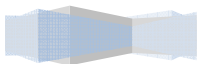

## **5.0 - Notice**

---

### **5.1 – Disclaimer**

---

All information, illustrations, and specifications contained in this user manual are based on the latest information available at the time of printing. The right is reserved to make any changes at any time without obligation to notify any person or organization of such revisions or changes.

Furthermore, the manufacturer or its sales agents are not liable for errors contained herein or for incidental or consequential damages (including lost profits) in connection with the furnishing, performance or use of this material.

This user manual tells how to use and perform the required procedures on vehicles. Safe and effective use of this Scan tool is very much dependant on the user following the normal practices and procedures outline in this manual.

## **6.0 - Warranty Information**

---

### **6.1 – Limited Warranty**

---

This limited warranty cover defects in materials and workmanship for a period of twelve (12) months which begins from the date the product is purchased by the end user and is subjected to the following terms and conditions:

1. Within the warranty period, the manufacturer will repair or replace, at their options, any defective parts and return to the owner in good working condition.
2. Any repaired or replaced parts will be warranted for the balance of the original warranty or three months (3) months from the date of repair, whichever is longer.
3. This warranty only extends to the first owner and not assignable or transferable to any subsequent owner.
4. Cost of delivery charges incurred for the repair of the product to and from the manufacturer will be borne by the owner.

5. This limited warranty covers only those defects that arises as a result of normal use and does not cover those that arises as a result of:
- Unauthorized modifications and repair.
  - Improper operation or misuse.
  - Accident or neglect such as dropping the unit onto hard surfaces.
  - Contact with water, rain or extreme humidity.
  - Contact with extreme heat.
  - Cables that have broken, bent contact pins or subject to extreme stress or wear.
  - Physical damage to the product surface including scratches, cracks or other damage to the display screen or other externally exposed parts.

## **6.2 - Limitations of Warranty**

Other than the foregoing limited warranty, the manufacturer does not make any other warranty or condition of any kind, whether express or implied.

Any implied warranty of merchantability, or fitness for use shall be limited to the duration of the foregoing limited warranty.

Otherwise, the foregoing limited warranty is the owner's sole and exclusive remedy and is in lieu of all other warranties whether express or implied.

The manufacturer or any of its exclusive sales agents shall not be liable for any consequential or incidental damages or losses arising of the loss of uses of this product.

All warranty information, product features and specifications are subjected to change without prior notice.

