

- TRMS CLAMP-ON • AC CURRENT
AC VOLTAGE • DC CURRENT
DC VOLTAGE • THERMOCOUPLE
TEMP/RH • EVENT LOGGER

Simple Logger® II Data Loggers



Statement of Compliance

Chauvin Arnoux®, Inc. d.b.a. AEMC® Instruments certifies that this instrument has been calibrated using standards and instruments traceable to international standards.

We guarantee that at the time of shipping your instrument has met its published specifications.

An NIST traceable certificate may be requested at the time of purchase, or obtained by returning the instrument to our repair and calibration facility, for a nominal charge.

The recommended calibration interval for this instrument is 12 months and begins on the date of receipt by the customer. For recalibration, please use our calibration services. Refer to our repair and calibration section at www.aemc.com.

Serial #: _____

Catalog #: _____

Model #: _____

Please fill in the appropriate date as indicated:

Date Received: _____

Date Calibration Due: _____



AEMC®
INSTRUMENTS

Chauvin Arnoux®, Inc.
d.b.a AEMC® Instruments
www.aemc.com

Table of Contents





1. INTRODUCTION.....	4
1.1 Symbols Used.....	5
1.2 Definition of Measurement Categories	5
1.3 Receiving Your Shipment.....	6
1.4 Ordering Information.....	6
1.4.1 Recommended Probes for Models L101/L102/L562	7
1.4.2 Recommended Probes for Model L111.....	8
1.4.3 Accessories and Replacement Parts.....	8
2. PRODUCT FEATURES	9
2.1 Description.....	9
2.2 Control Features.....	10
2.2.1 Standard Models.....	10
2.2.2 Clamp-on Model CL601	12
3. SPECIFICATIONS.....	14
4. OPERATION	26
4.1 LED Control Operation and Status Function	26
4.2 Connecting the Simple Logger® II to a Computer	28
4.3 Recording Data.....	29
4.3.1 Starting a Recording Session	29
4.3.2 Stopping a Recording Session	30
4.4 Downloading Recorded Data.....	30
4.5 Clearing Alarm Indication.....	30
4.6 Erasing Data from Memory.....	31
4.7 Data Storage.....	32
4.7.1 Trend Measurements.....	32
4.8 Logger Operation.....	32
4.8.1 Recording with Memory Cleared	33
4.8.2 Recording with a Partial or Full Memory.....	33
4.8.3 Memory Filled During Recording Session	33
4.8.4 Battery Power Insufficient for a Full Recording.....	34

4.8.5	Recording Session has Ended	34
4.9	Event Logger Operation (Model L404 Only)	35
4.9.1	Sample Event Capture	36
4.9.2	Application Examples	36
4.10	Reset Switch Operation	37
4.11	Flash Upgrade Switches	38
5.	SOFTWARE INSTALLATION	39
5.1	Installing DataView®	39
5.2	Opening the Control Panel	43
5.3	Using the Control Panel	44
5.4	Configuring the Simple Logger® II	47
5.4.1	Setting Recording Options	49
5.4.2	Setting Scales Options	52
5.4.3	Setting Alarm Options	53
5.4.4	Configuring and Recording Data	55
5.4.5	Saving and Recalling a Configuration	56
5.5	Displaying Real-time Status Information	57
5.6	Resizing and Saving Real-time Window Layouts	58
5.7	Displaying Real-time Graphs and Text	59
5.8	Saving Real-time Measurements	60
5.9	Downloading Recorded Instrument Data	63
5.10	Simple Logger® II Templates	63
6.	MAINTENANCE	70
6.1	Replacing the Batteries	70
6.2	Replacing the Fuse (Model L111)	71
6.3	Cleaning	71
APPENDIX A:	TROUBLESHOOTING	72
APPENDIX B:	GLOSSARY	73
Repair and Calibration		74
Technical and Sales Assistance		74
Limited Warranty		75
Warranty Repairs		75













INTRODUCTION

WARNING

These instruments comply with safety standard EN 61010-1 (Ed 2-2001) or EN 61010-2-032 (2002) for voltages and categories of installation, at an altitude below 2000m and indoors, with a degree of pollution at most equal to 2.

- Do not use in explosive atmosphere or in the presence of flammable gases or fumes.
- Do not use on voltage networks greater than categories mentioned above.
- Observe the maximum voltages and intensities assigned between terminals and earth.
- Do not use it if appears damaged, incomplete or improperly closed.
- Before each use, check the condition of the insulation of cables, case and accessories. Anything which appears damaged (even partially) must be reported for repair or scrapping.
- Use leads and accessories of voltages and categories at least equal to those of the instrument.
- Observe the environmental conditions of use.
- Use only recommended fuse.  Disconnect all leads before replacing the fuse (L111).
- Do not modify the instrument and use only original replacement parts. Repairs or adjustments must be performed by authorized personnel.
- Replace the batteries when the “Low Bat” LED is blinking.  Disconnect all cables from the instrument or remove the clamp on from the cable before opening the access door to the batteries.
-  Use protective equipment when security conditions are required.
-  Keep your hands away from unused terminals of the device.
-  When handling probes, probe tips, current sensors and alligators clips, keep fingers behind the guards.
- For measurements of dangerous voltages, first connect the black lead to the black terminal of the instrument and then connect this lead to the low voltage point of the source to measure (potential closer to Earth). Then connect the red lead to the red terminal of the instrument and connect the lead to the hot source to measure. Disconnection must be done respecting the reverse order, first disconnect the hot lead and then red then black lead.

1.1 Symbols Used

	Signifies that the instrument is protected by double or reinforced insulation.
	CAUTION - Risk of Danger! Indicates a WARNING and that the operator must refer to the user manual for instructions before operating the instrument in all cases where this symbol is marked.
	Risk of electric shock. The voltage at the parts marked with this symbol may be dangerous.
	Refers to a type A current sensor. This symbol signifies that application around and removal from HAZARDOUS LIVE conductors is permitted.
	Ground/Earth
	Important instructions to read and understand completely.
	Important information to acknowledge.
	Battery
	Fuse
	USB socket
	Compliance with the Low Voltage & Electromagnetic Compatibility European directives (73/23/CEE & 89/336/CEE)
	In the European Union, this product is subject to a separate collection system for recycling electrical and electronic components In accordance with directive WEEE 2002/96/EC

1.2 Definition of Measurement Categories

- CAT I:** For measurements on circuits not directly connected to the AC supply wall outlet such as specially protected lines (mains) derived circuits.
- CAT II:** For measurements performed on circuits directly connected to the electrical distribution system (AC supply wall outlet). Examples are measurements on household appliances or portable tools.
- CAT III:** For measurements performed in the building installation at the distribution level such as on hardwired equipment in fixed installation and circuit breakers.
- CAT IV:** For measurements performed at the primary electrical supply (< 1000V) such as on primary overcurrent protection devices, ripple control units, or meters.

1.3 Receiving Your Shipment

Upon receiving your shipment, make sure that the contents are consistent with the packing list. Notify your distributor of any missing items. If the equipment appears to be damaged, file a claim immediately with the carrier and notify your distributor at once, giving a detailed description of any damage. Save the damaged packing container to substantiate your claim.

1.4 Ordering Information

Simple Logger® II Model CL601 **Cat. #2126.01**
(1-Channel, TRMS Clamp-on 600AAC)

Includes USB cable, DataView® software, 2x1.5V AA-cell alkaline batteries and user manual.

Simple Logger® II Model L101 **Cat. #2126.02**
(1-Channel, TRMS 0 to 1VAC)

Includes a USB cable, DataView® software, 2x1.5V AA-cell alkaline batteries and user manual. Probes purchased separately.

Simple Logger® II Model L102 **Cat. #2126.03**
(2-Channel, TRMS 0 to 1VAC)

Includes a USB cable, DataView® software, 2x1.5V AA-cell alkaline batteries and user manual. Probes purchased separately.

Simple Logger® II Model L111 **Cat. #2126.04**
(1-Channel, TRMS 0 to 1AAC)

Includes a USB cable, DataView® software, 2x1.5V AA-cell alkaline batteries, one fuse 2A (250V) and user manual. Probes purchased separately.

Simple Logger® II Model L261 **Cat. #2126.05**
(1-Channel, TRMS 600VAC/DC)

Includes USB cable, DataView® software, 2x1.5V AA-cell alkaline batteries, one set of leads, one set of alligator clips and user manual.

Simple Logger® II Model L322 **Cat. #2126.06**
(2-Channel, 4 to 20mADC, Current)

Includes USB cable, one 4-position terminal block connector, DataView® software, 2x1.5V AA-cell alkaline batteries and user manual.

Simple Logger® II Model L404 **Cat. #2126.29**
(4-Channel, Event Logger)

Includes USB cable, one 8-position terminal block connector, DataView® software, 2x1.5V AA-cell alkaline batteries and user manual.

- Simple Logger® II Model L432** **Cat. #2126.07**
 (2-Channel, DC $\pm 100\text{mV}$ / 1V / 10VDC)
Includes USB cable, one 4-position terminal block connector, DataView® software, 2x1.5V AA alkaline batteries and user manual.
- Simple Logger® II Model L481** **Cat. #2126.25**
 (1-Channel, $\pm 850\text{VDC}$)
Includes USB cable, DataView® software, 2x1.5V AA alkaline batteries, one set of leads, one set of alligator clips and user manual.
- Simple Logger® II Model L562** **Cat. #2126.35**
 (2-Channel, TRMS 600V Voltage Input & 1V Current Probe Input)
Includes USB cable, DataView® software, 2x1.5V AA alkaline batteries, one set of leads, one set of alligator clips and user manual. Probes purchased separately.
- Simple Logger® II Model L642** **Cat. #2126.08**
 (2-Channel, Temperature Thermocouple)
Includes USB cable, DataView® software, 2x1.5V AA alkaline batteries and user manual.
- Simple Logger® II Model L702** **Cat. #2126.09**
 (2-Channel, Temp/RH Logger)
Includes USB cable, DataView® software, 2x1.5V AA alkaline batteries and user manual.
- Simple Logger® II Model ML912** **Cat. #2126.37**
 (2-Channel, TRMS, MiniFlex® 100/1000AAC)
Includes USB cable, DataView® software, 2x1.5V AA alkaline batteries and user manual.

1.4.1 Recommended Probes for Models L101, L102 & L562

AC Current Probe Model MN261
 (24A-100mV/A, 240A-10mV/A, BNC) **Cat. #2115.82**

NOTE: The MN261 current probe should not be used on applications above 10 or 100 Amps (depending on range) when used with either the L101 or L102 data loggers. Clipping of the input signal could result.

AC Current Probe Model SR661
 (10A-100mV/A, 100A-10mV/A, 1000A-1mV/A, BNC) **Cat. #2113.49**

AC Current Probe Model JM861
 (30A-10mV/A, 300A-1mV/A, 3000A-0.1mV/A, BNC) **Cat. #2110.90**

AC Current Probe Model MN379
 (5A-200mV/A; 100A-10mV/A, Lead) **Cat. #2153.01**

1.4.2 Recommended Probes for Model L111

AC Current Probe Model MN313 (150A, 1mA/A, Lead)	Cat. #2116.25
AC Current Probe Model SR604 (1000A, 1mA/A, Lead)	Cat. #2113.44
AC Current Probe Model JM830A (3000A, .333mA/A, Lead)	Cat. #2110.83
AC Current Probe Model MN01 (150A, 1mA/A, Lead).....	Cat. #2129.17
AC Current Probe Model MN02 (100A, 1mA/A, Lead, 1% Accuracy)	Cat. #2129.20

1.4.3 Accessories and Replacement Parts

110V Outlet Adapter w/4mm Banana Plug	Cat. #2118.49
Thermocouple - Needle (12 x 5.9"), K Type, -58° to 1292° F (Model L642).....	Cat. #2126.46
Thermocouple - Flexible (1.2mm), K Type, -58° to 480° F (Model L642).....	Cat. #2126.47
Fuse - Set of 5, 2A (250V) FA (Model L111).....	Cat. #2126.48
Replacement - Type A to 5-pin mini-B 2M USB cable	Cat. #2126.49
Small Classic Carrying Bag	Cat. #2133.72
Lead - Set of 2, color-coded 5 ft w/color-coded alligator clips (Rated 600V CAT IV, 15A).....	Cat. #2140.62
Lead - Set of 2, color-coded 10 ft w/color-coded alligator clips (Rated 600V CAT IV, 15A).....	Cat. #2140.63

Order Accessories and Replacement Parts Directly Online

Check our Storefront at www.aemc.com/store for availability

PRODUCT FEATURES

2.1 Description

The Simple Logger® II Series include one and two channel recording devices (model dependent) powered by alkaline batteries. For AC units, line tracking is performed such that 64 samples over one line cycle are taken. Frequency tracking is performed over the range of ± 2 Hz around the nominal line frequency (50 or 60Hz). Harmonic measurements are calculated from these 64 samples (harmonics are only available from the Simple Logger® II Control Panel within the DataView® software).

The Simple Logger® II records at a rate of up to eight times per second (model dependent). Samples are taken at a user defined storage rate. This means that the input(s) are ignored between measurement intervals.

Battery operation and compact size allows for installation in tight locations without the need for external power. A series of front panel LEDs provide a quick status of the logger's state and memory usage.

The main advantage of the logger is its ability to perform a variety of recording tasks with easy and intuitive setup from a computer using DataView® software.

Analog information on the input is sampled and converted to a digital value. This digital signal is processed and stored along with scale and time information. An optically isolated Universal Serial Bus (USB) port provides for the transfer of data from the instrument's internal memory to the computer for analysis.

2.2 Control Features

2.2.1 Standard Models

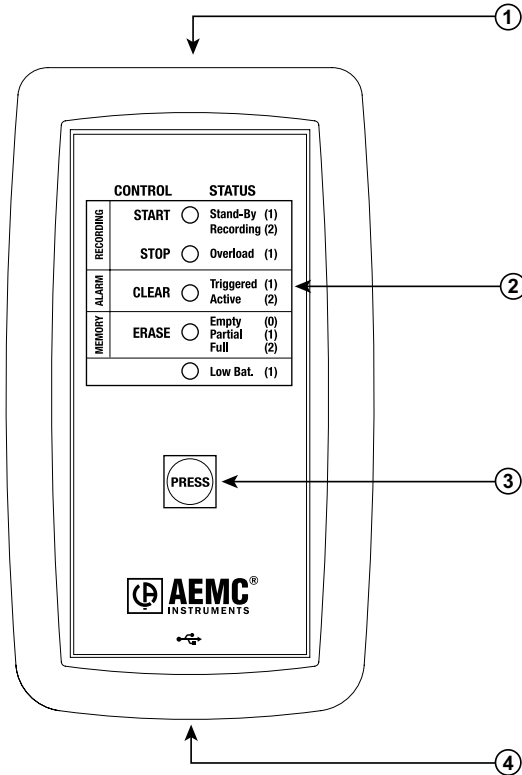

Figure 2-1

1. Input (model dependent)

L101/L102 - BNC Input Termination

L261/L481 - Two recessed 4mm safety banana jacks

L111 - Two recessed 4mm safety banana jacks and fuse location

L322/L432 - One 4-position removable screw-type terminal block

L404 - One 8-position removable screw-type terminal block

L562 - BNC/Two recessed 4mm safety banana jacks

L642 - Two miniature thermocouple connectors

L702 - Temp/RH Sensor

ML912 - Two captive MiniFlex® sensors

2. Five LED Indicators

The LEDs on the logger serve two functions: **Control Operation** and **Status Function**.

- The control operation (when holding down the PRESS button) is indicated with text to the left of each LED.
- The status function (when PRESS is not being held down) associated with each LED is indicated with text to the right of each LED.
- Refer to § 4.1 for detailed descriptions of each LED.

3. Control Button (PRESS)

This button marked “PRESS” selects the mode of operation. Use this button to start or stop recordings, erase the memory, clear alarms and turn the instrument ON/OFF.

4. Female Type Mini-B USB Connector

This connector is located on the bottom of the instrument.

5. Reset Switch (not shown)

The **RESET** switch resets the CPU. To access this switch, remove the battery compartment cover then remove the four screws holding the two halves of the case together. The reset switch is located on the exposed PCB near the inputs (refer to § 4.11).

6. Flash Upgrade Switches (not shown)

These two switches (accessible from under the top cover), the **RESET** switch and upgrade software are used to recover from a failed flash upgrade procedure (refer to § 4.12).



WARNING: If the **RESET** switch is pressed when the logger is recording, data in memory may be lost.

2.2.2 Clamp-on Model CL601

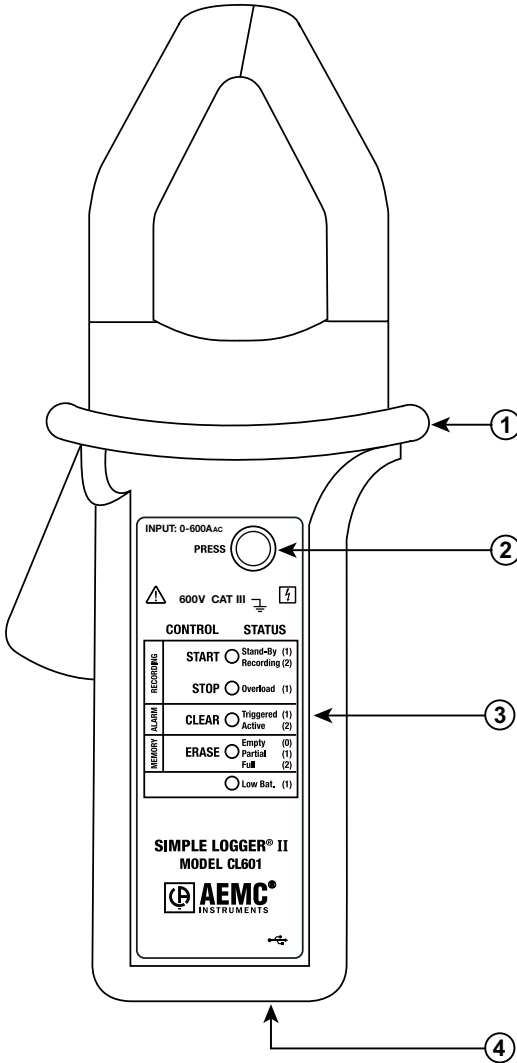

Figure 2-2

1. Safety barrier anti-slip guard

For safety purposes, always hold the probe under the guard.

2. Control Button (PRESS)

This button marked “PRESS” selects the mode of operation. Use this button to start or stop recordings, erase the memory and clear alarms.

3. Five LED Indicators

The LEDs on the instrument serve two functions: control operation and status function.

- The control operation (function when holding down the PRESS button) is indicated with text to the left of each LED.
- The status function (function when PRESS is not being held down) associated with each LED is indicated with text to the right of each LED.
- Refer to § 4.1 for detailed descriptions of each LED.

4. Female Type Mini-B USB Connector

5. Reset Switch (not shown)

The **RESET** switch resets the CPU. To access the switch, remove the battery compartment cover. The switch is located at the top left of the battery compartment (refer to § 4.11).

6. Flash Upgrade Switches (not shown)

These two switches (accessible from under the battery compartment), the **RESET** switch and upgrade software are used to recover from a failed flash upgrade procedure (refer to § 4.12).



WARNING: If the **RESET** switch is pressed when the logger is recording, data in memory may be lost.

CHAPTER 3

SPECIFICATIONS

Reference Conditions: 23°C ± 3°C, 30-50% RH, DC or 50/60 Hz, no AC external magnetic field, DC magnetic field ≤ 40A/m, centered conductor, battery voltage: 3V ± 10%.

MODEL	L101	L102
ELECTRICAL		
Channels	One	Two
Input	BNC	
Input Level	0 to 1V _{AC}	
Accuracy (50/60Hz)	0 to 10mV unspecified 10 to 50mV: ±(0.5% of Reading +1mV) 50 to 1000mV: ±(0.5% of Reading +0.5mV)	
Resolution	0.1mV _{AC}	
Maximum Input Voltage***	5V _{rms} or ± 7.07V _{PEAK}	
Input Impedance	800kΩ	
Sample Rate	64 samples/cycle	
Storage Rate	Programmable from 125ms to 1 per day	
Storage Modes	Start/Stop, FIFO and Extended Recording Mode* (XRM™), Alarm	
Recording Length	15 minutes to 8 weeks, programmable using DataView®	
Memory	240,000 measurement (512kB). Recorded data is stored in non-volatile memory and retained even if battery is low or removed.	
Communication	USB 2.0 optically isolated	
Power Source**	2x1.5V AA (LR6) alkaline batteries	
Battery Life	100 hrs to >45 days (dependent on storage rate/recording length)	
MECHANICAL		
Dimensions	5.38 x 2.75 x 1.28" (136 x 70 x 32mm)	
Weight (with battery)	6.4 oz (180g)	
Case	UL94-V0	
Vibration	IEC 68-2-6 (1.5mm, 10 to 55Hz)	
Shock	IEC 68-2-27 (30G)	
Drop	IEC 68-2-32 (1m)	
ENVIRONMENTAL		
Operating Temperature	14° to 122°F (-10° to 50°C)	
Storage Temperature	-4° to 140°F (-20° to 60°C)	
Relative Humidity	Up to 85% at 95°F (35°C), Non-condensing	
Altitude	2000m	
SAFETY & ELECTRO-MAGNETIC COMPATIBILITY		
Safety Rating	EN 61010-1; 50V CAT III; Pollution Degree 2	
Protection Degree	IP40	
Electro-Magnetic Compatibility	EN 61326-1; 07/1997 (+A1 10/1998, +A2 09/2001, +A3 05/2004)	
CE Approved	Yes	

MODEL	L111
ELECTRICAL	
Channels	One
Input	Two recessed banana jacks
Input Level	0 to 1Aac
Accuracy (50/60Hz)	0 to 10mA unspecified 10 to 50mA: $\pm(0.5\%$ of Reading +1mA) 50 to 1000mA: $\pm(0.5\%$ of Reading +0.5mA)
Resolution	0.1mA
Maximum Input Current***	1.2A
Input Impedance	1 Ω
Sample Rate	64 samples/cycle
Storage Rate	Programmable from 125ms to 1 per day
Storage Modes	Start/Stop, FIFO and Extended Recording Mode* (XRM™), Alarm
Recording Length	15 minutes to 8 weeks, programmable using DataView®
Memory	240,000 measurement (512kB). Recorded data is stored in non-volatile memory and retained even if battery is low or removed.
Communication	USB 2.0 optically isolated
Fuse	2A FA 250V 5x20mm
Power Source**	2x1.5V AA (LR6) alkaline batteries
Battery Life	100 hours to >45 days (dependent on storage rate/recording length)
MECHANICAL	
Dimensions	5.18 x 2.75 x 1.28" (132 x 70 x 32mm)
Weight (with battery)	6.64 oz (188g)
Case	UL94-V0
Vibration	IEC 68-2-6 (1.5mm, 10 to 55Hz)
Shock	IEC 68-2-27 (30G)
Drop	IEC 68-2-32 (1m)
ENVIRONMENTAL	
Operating Temperature	14° to 122°F (-10° to 50°C)
Storage Temperature	-4° to 140°F (-20° to 60°C)
Relative Humidity	Up to 85% at 95°F (35°C), Non-condensing
Altitude	2000m
SAFETY & ELECTRO-MAGNETIC COMPATIBILITY	
Safety Rating	EN 61010-1; 50V CAT III; Pollution Degree 2
Protection Degree	IP40
Electro-Magnetic Compatibility	EN 61326-1; 07/1997 (+A1 10/1998, +A2 09/2001, +A3 05/2004)
CE Approved	Yes

MODEL	L261
ELECTRICAL	
Channels	One
Input	Two recessed 4mm safety banana jacks
Input Level	0 to 600V _{AC/DC}
Accuracy (50/60Hz)	0 to 5V: unspecified 5 to 50V: ±(0.5% of Reading +1V) 50 to 600V: ±(0.5% of Reading +0.5V)
Resolution	0.1V
Maximum Input Voltage***	1.2 x 600V
Input Impedance	40MΩ
Sample Rate	64 samples/cycle
Storage Rate	Programmable from 125ms to 1 per day
Storage Modes	Start/Stop, FIFO and Extended Recording Mode* (XRM™), Alarm
Recording Length	15 minutes to 8 weeks, programmable using DataView®
Memory	240,000 measurement (512KB). Recorded data is stored in non-volatile memory and retained even if battery is low or removed.
Communication	USB 2.0 optically isolated
Power Source**	2x1.5V AA (LR6) alkaline batteries
Battery Life	100 hours to >45 days (dependent on storage rate/recording length)
MECHANICAL	
Dimensions	4.94 x 2.75 x 1.28" (125 x 70 x 32mm)
Weight (with battery)	6.4 oz (180g)
Case	UL94-V0
Vibration	IEC 68-2-6 (1.5mm, 10 to 55Hz)
Shock	IEC 68-2-27 (30G)
Drop	IEC 68-2-32 (1m)
ENVIRONMENTAL	
Operating Temperature	14° to 122°F (-10° to 50°C)
Storage Temperature	-4° to 140°F (-20° to 60°C)
Relative Humidity	Up to 85% at 95°F (35°C), Non-condensing
Altitude	2000m
SAFETY & ELECTRO-MAGNETIC COMPATIBILITY	
Safety Rating	EN61010-1; 600V CAT III, 300V CAT IV; Pollution Degree 2
Protection Degree	IP40
Electro-Magnetic Compatibility	EN 61326-1; 07/1997 (+A1 10/1998, +A2 09/2001, +A3 05/2004)
CE Approved	Yes

MODEL	L322
ELECTRICAL	
Channels	Two
Input	One 4-position removable screw-type terminal block
Input Level	-20mV _{AC} to +20mV _{AC}
Accuracy	(0.25% of Reading +0.05mA)
Resolution	0.01mA
Maximum Input Current***	±24mV _{AC}
Input Impedance	50Ω
Sample Rate	Maximum of 8 samples taken at storage interval
Storage Rate	Programmable from 125ms to 1 per day
Storage Modes	Start/Stop, FIFO and Extended Recording Mode* (XRM™), Alarm
Recording Length	15 minutes to 8 weeks, programmable using DataView®
Memory	240,000 measurement (512KB). Recorded data is stored in non-volatile memory and retained even if battery is low or removed.
Communication	USB 2.0 optically isolated
Power Source**	2x1.5V AA (LR6) alkaline batteries
Battery Life	100 hours to >45 days (dependent on storage rate/recording length)
MECHANICAL	
Dimensions	5.45 x 2.75 x 1.28" (136 x 70 x 32mm)
Weight (with battery)	6.4 oz (181g)
Case	UL94-V0
Vibration	IEC 68-2-6 (1.5mm, 10 to 55Hz)
Shock	IEC 68-2-27 (30G)
Drop	IEC 68-2-32 (1m)
ENVIRONMENTAL	
Operating Temperature	14° to 122°F (-10° to 50°C)
Storage Temperature	-4° to 140°F (-20° to 60°C)
Relative Humidity	Up to 85% at 95°F (35°C), Non-condensing
Altitude	2000m
SAFETY & ELECTRO-MAGNETIC COMPATIBILITY	
Safety Rating	EN 61010-1; 50V CAT III; Pollution Degree 2
Protection Degree	IP40
Electro-Magnetic Compatibility	EN 61326-1; 07/1997 (+A1 10/1998, +A2 09/2001, +A3 05/2004)
CE Approved	Yes

MODEL	L404
ELECTRICAL	
Channels	Four
Input	One 8-position removable screw-type terminal block
Input Level	Contact closure, 0 to 5V
Maximum Input Voltage***	10V _{dc}
Input Impedance	> 150K Ω
Sample Rate	Maximum of 8 per second
Storage Rate	Maximum once every two sample periods (event dependent)
Storage Mode	Event Recording ⁽¹⁾
Recording Length	15 minutes to 8 weeks, programmable using DataView®
Memory	50,000 events (512KB). Recorded data is stored in non-volatile memory and retained even if battery is low or removed.
Communication	USB 2.0 optically isolated
Power Source**	2x1.5V AA (LR6) alkaline batteries
Battery Life	100 hours to >45 days (dependent on storage rate/recording length)
MECHANICAL	
Dimensions	5.45 x 2.75 x 1.28" (136 x 70 x 32mm)
Weight (with battery)	6.4 oz (181g)
Case	Polycarbonate UL94-V0
Vibration	IEC 68-2-6 (1.5mm, 10 to 55Hz)
Shock	IEC 68-2-27 (30G)
Drop	IEC 68-2-32 (1m)
ENVIRONMENTAL	
Operating Temperature	14° to 122°F (-10° to 50°C)
Storage Temperature	-4° to 140°F (-20° to 60°C)
Relative Humidity	Up to 85% at 95°F (35°C), Non-condensing
Altitude	2000m
SAFETY & ELECTRO-MAGNETIC COMPATIBILITY	
Safety Rating	EN 61010-1; 50V CAT III; Pollution Degree 2
Protection Degree	IP40
CE Approved	Yes

(1) This recording mode stores the time and duration of the event, and the channel the event occurred on. An event occurs when the input falls below 0.7V and ends when it rises above 0.8V. An internal pull up is provided for contact closure.

MODEL	L432
ELECTRICAL	
Channels	Two
Input	One 4-position removable screw-type terminal block
Input Level (3 ranges/channel)	Range 1: -100mV to 100mVdc Range 2: -1V to 1Vdc Range 3: -10V to 10Vdc
Accuracy	Range 1: $\pm(0.5\%$ of Reading +1mV) Range 2: $\pm(0.5\%$ of Reading +1mV) Range 3: $\pm(0.5\%$ of Reading +10mV)
Resolution	Range 1: 0.1mV Range 2: 1mV Range 3: 10mV
Maximum Input Voltage***	$\pm(1.2 \times \text{Nominal Range})$
Input Impedance	100mV/1V: 80k Ω ; 10V: 800k Ω
Sample Rate	Maximum of 8 samples taken at storage interval
Storage Rate	Programmable from 125ms to 1 per day
Storage Modes	Start/Stop, FIFO and Extended Recording Mode* (XRM™), Alarm
Recording Length	15 minutes to 8 weeks, programmable using DataView®
Memory	240,000 measurement (512KB). Recorded data is stored in non-volatile memory and retained even if battery is low or removed.
Communication	USB 2.0 optically isolated
Power Source**	2x1.5V AA (LR6) alkaline batteries
Battery Life	100 hours to >45 days (dependent on storage rate/recording length)
MECHANICAL	
Dimensions	5.45 x 2.75 x 1.28" (136 x 70 x 32mm)
Weight (with battery)	6.4 oz (181g)
Case	UL94-V0
Vibration	IEC 68-2-6 (1.5mm, 10 to 55Hz)
Shock	IEC 68-2-27 (30G)
Drop	IEC 68-2-32 (1m)
ENVIRONMENTAL	
Operating Temperature	14° to 122°F (-10° to 50°C)
Storage Temperature	-4° to 140°F (-20° to 60°C)
Relative Humidity	Up to 85% at 95°F (35°C), Non-condensing
Altitude	2000m
SAFETY & ELECTRO-MAGNETIC COMPATIBILITY	
Safety Rating	EN 61010-1; 50V CAT III; Pollution Degree 2
Protection Degree	IP40
Electro-Magnetic Compatibility	EN 61326-1; 07/1997 (+A1 10/1998, +A2 09/2001, +A3 05/2004)
CE Approved	Yes

MODEL	L481
ELECTRICAL	
Channels	One
Input	Two recessed 4mm safety banana jacks
Input Level	-850Vdc to +850Vdc
Accuracy (50/60Hz)	0 to 5V: unspecified 5 to 50V: $\pm(0.5\%$ of Reading +1V) 50 to 850V: $\pm(0.5\%$ of Reading +0.5V)
Resolution	0.1V
Maximum Input Voltage***	$\pm 1020Vdc$
Input Impedance	40M Ω
Sample Rate	Maximum of 8 per second
Storage Rate	Programmable from 125ms to 1 per day
Storage Modes	Start/Stop, FIFO and Extended Recording Mode* (XRM™), Alarm
Recording Length	15 minutes to 8 weeks, programmable using DataView®
Memory	240,000 measurement (512KB). Recorded data is stored in non-volatile memory and retained even if battery is low or removed.
Communication	USB 2.0 optically isolated
Power Source**	2x1.5V AA (LR6) alkaline batteries
Battery Life	100 hours to >45 days (dependent on storage rate/recording length)
MECHANICAL	
Dimensions	4.94 x 2.75 x 1.28" (125 x 70 x 32mm)
Weight (with battery)	6.4 oz (180g)
Case	UL94-V0
Vibration	IEC 68-2-6 (1.5mm, 10 to 55Hz)
Shock	IEC 68-2-27 (30G)
Drop	IEC 68-2-32 (1m)
ENVIRONMENTAL	
Operating Temperature	14° to 122°F (-10° to 50°C)
Storage Temperature	-4° to 140°F (-20° to 60°C)
Relative Humidity	Up to 85% at 95°F (35°C), Non-condensing
Altitude	2000m
SAFETY & ELECTRO-MAGNETIC COMPATIBILITY	
Safety Rating	EN61010-1; 600V CAT III, 300V CAT IV; Pollution Degree 2
Protection Degree	IP40
CE Approved	Yes

MODEL	L562	
ELECTRICAL		
Channels	Two	
Connection	Current Channel	Voltage Channel
Input	BNC	Two recessed banana jacks
Input Level	0 to 1V (for use with current probes with a voltage output)	0 to 600V _{AC}
Accuracy (50/60Hz)	0 to 10mV unspecified 10 to 50mV: ±(0.5% of Reading + 1mV) 50 to 1000mV: ±(0.5% of Reading + 0.5mV)	0 to 5V unspecified 5 to 50V: ±(0.5% of Reading + 1V) 50 to 600V: ±(0.5% of Reading + 0.5V)
Resolution	0.1mV	0.1V
Maximum Input Voltage***	5V _{rms} or ± 7.07V _{PEAK}	1.2 x 600V
Input Impedance	800k Ω	40M Ω
Sample Rate	64 samples/cycle	
Storage Rate	Programmable from 125ms to 1 per day	
Storage Modes	Start/Stop, FIFO and Extended Recording Mode* (XRM™), Alarm	
Recording Length	15 minutes to 8 weeks, programmable using DataView®	
Memory	240,000 measurements (512KB). Recorded data is stored in non-volatile memory and retained even if battery is low or removed.	
Communication	USB 2.0 optically isolated	
Power Source**	2x1.5V AA-cell alkaline batteries	
Battery Life	100 hours to >45 days (dependent on storage rate/recording length)	
MECHANICAL		
Dimensions	5.38 x 2.75 x 1.28" (136 x 70 x 32mm)	
Weight (with battery)	6.4 oz (180g)	
Case	UL94-V0	
Vibration	IEC 68-2-6 (1.5mm, 10 to 55Hz)	
Shock	IEC 68-2-27 (30G)	
Drop	IEC 68-2-32 (1m)	
ENVIRONMENTAL		
Operating Temperature	14° to 122°F (-10° to 50°C)	
Storage Temperature	-4° to 140°F (-20° to 60°C)	
Relative Humidity	Up to 85% at 95°F (35°C), Non-condensing	
Altitude	2000m	
SAFETY & ELECTRO-MAGNETIC COMPATIBILITY		
Safety Rating	EN61010-1; 600V CAT III, 300V CAT IV; Pollution Degree 2	
Protection Degree	IP40	
Electro-Magnetic Compatibility	EN 61326-1; 07/1997 (+A1 10/1998, +A2 09/2001, +A3 05/2004)	
CE Approved	Yes	

MODEL	L642			
ELECTRICAL				
Channels	Two			
Input	Two miniature thermocouple connectors			
Measurement Range: (thermocouple dependent)	°F	°C		
	J	-346 to +2192	J	-210 to +1200
	K	-328 to +2501	K	-200 to +1372
	T	-328 to +752	T	-200 to +400
	N	-328 to +2372	N	-200 to +1300
	E	-238 to 1742	E	-150 to +950
	R	32 to 3212	R	0 to 1767
	S	32 to 3212	S	0 to 1767
Resolution	$\theta < 1000^{\circ}\text{F}$ or $^{\circ}\text{C} \rightarrow 0.1^{\circ}\text{F}$ or $^{\circ}\text{C}$ $\theta \geq 1000^{\circ}\text{F}$ or $^{\circ}\text{C} \rightarrow 1^{\circ}\text{F}$ or $^{\circ}\text{C}$			
Accuracy (J, K, T, N, E)	$\theta \leq -148^{\circ}\text{F}/-100^{\circ}\text{C} \rightarrow \pm (0.2\% \text{ of Reading} + 1.1^{\circ}\text{F}/0.6^{\circ}\text{C})$ $-148^{\circ}\text{F}/-100^{\circ}\text{C} < \theta \leq +212^{\circ}\text{F}/+100^{\circ}\text{C} \rightarrow$ $\pm (0.15\% \text{ of Reading} + 1.1^{\circ}\text{F}/0.6^{\circ}\text{C})$ $\theta > +212^{\circ}\text{F}/+100^{\circ}\text{C} \rightarrow \pm (0.1\% \text{ of Reading} + 1.1^{\circ}\text{F}/0.6^{\circ}\text{C})$			
Accuracy (R, S)	$\theta = 32^{\circ}\text{F}/0^{\circ}\text{C}$ to $+212^{\circ}\text{F}/+100^{\circ}\text{C} \rightarrow$ $\pm (0.15\% \text{ of Reading} + 1.8^{\circ}\text{F}/1.0^{\circ}\text{C})$ $\theta > +212^{\circ}\text{F}/+100^{\circ}\text{C} \rightarrow \pm (0.1\% \text{ of Reading} + 1.8^{\circ}\text{F}/1.0^{\circ}\text{C})$			
Temperature Coefficient:	$\pm (0.02\% \text{ of Reading} + 0.03^{\circ}\text{C})/^{\circ}\text{C}$ or $\pm (0.02\% \text{ of Reading} + 0.03^{\circ}\text{F})/^{\circ}\text{F}$ between operating temperature of -10°C to $+18^{\circ}\text{C}$ and $+28^{\circ}\text{C}$ to $+50^{\circ}\text{C}$			
Maximum Differential Voltage	1V (between inputs)			
Sample Rate	Maximum of 8 samples taken at storage interval			
Storage Rate	Programmable from 5 seconds to 1 per day			
Storage Modes	Start/Stop, FIFO and Extended Recording Mode* (XRM™), Alarm			
Recording Length	15 minutes to 8 weeks, programmable using DataView®			
Memory	240,000 measurement (512KB). Recorded data is stored in non-volatile memory and retained even if battery is low or removed.			
Communication	USB 2.0 optically isolated			
Power Source**	2x1.5V AA (LR6) alkaline batteries			
Battery Life	100 hours to >45 days (dependent on storage rate/recording length)			
MECHANICAL				
Dimensions	4.94 x 2.75 x 1.28" (125 x 70 x 32mm)			
Weight (with battery)	7 oz (200g)			
Case	UL94-V0			
Vibration	IEC 68-2-6 (1.5mm, 10 to 55Hz)			
Shock	IEC 68-2-27 (30G)			
Drop	IEC 68-2-32 (1m)			
ENVIRONMENTAL				
Operating Temperature	14° to 122°F (-10° to 50°C)			
Storage Temperature	-4° to 140°F (-20° to 60°C)			
Relative Humidity	Up to 85% at 95°F (35°C), Non-condensing			
Altitude	2000m			
SAFETY & ELECTRO-MAGNETIC COMPATIBILITY				
Safety Rating	EN61010-1; 50V CAT III; Pollution Degree 2			
Protection Degree	IP40			
CE Approved	Yes			

MODEL	L702	
ELECTRICAL		
Channels	Two	
Input	Temperature Sensor	Humidity Sensor
Range	14° to 122°F (-10° to 50°C)	5 to 85% RH
Accuracy	± (1% of Reading + 1°F/C)	± (3% of Reading + 2cts)
Resolution	0.1 °F/C	0.1% RH
Sample Rate	Maximum of 1 every 5 seconds	
Storage Rate	Programmable from once every 5s to 1 per day	
Storage Modes	Start/Stop, FIFO and Extended Recording Mode* (XRM™), Alarm	
Recording Length	15 minutes to 8 weeks, programmable using DataView®	
Memory	240,000 measurements (512KB). Recorded data is stored in non-volatile memory and retained even if battery is low or removed.	
Communication	USB 2.0 optically isolated	
Power Source**	2x1.5V AA-cell alkaline batteries	
Battery Life	100 hours to >45 days (dependent on storage rate/recording length)	
MECHANICAL		
Dimensions	4.94 x 2.75 x 1.28" (136 x 70 x 32mm) w/o Sensor	
Weight (with battery)	6.4 oz (180g)	
Case	UL94-V0	
Vibration	IEC 68-2-6 (1.5mm, 10 to 55Hz)	
Shock	IEC 68-2-27 (30G)	
Drop	IEC 68-2-32 (1m)	
ENVIRONMENTAL		
Operating Temperature	14° to 122°F (-10° to 50°C)	
Storage Temperature	-4° to 140°F (-20° to 60°C)	
Relative Humidity	Up to 85% at 95°F (35°C), Non-condensing	
Altitude	2000m	
SAFETY & ELECTRO-MAGNETIC COMPATIBILITY		
Safety Rating	EN61010-1; 50V CAT III; Pollution Degree 2	
Protection Degree	IP40	
CE Approved	Yes	

MODEL	ML912	
ELECTRICAL		
Channels	Two	
Input	Captive MiniFlex® AC Current Flexible Sensors	
Range	0.5 to 100Aac	5 to 1000Aac
Accuracy (50/60Hz)	0 to 1A unspecified 1 to 100A: ±(1% of Reading + 0.5A)	0 to 5A unspecified 5 to 1000A: ±(1% of Reading + 1A)
Resolution	0.1A	
Sample Rate	64 samples/cycle	
Storage Rate	Programmable from 125ms to 1 day	
Storage Modes	Start/Stop, FIFO and Extended Recording Mode* (XRM™), Alarm	
Recording Length	15 minutes to 8 weeks, programmable using DataView®	
Memory	240,000 measurements (512KB). Recorded data is stored in non-volatile memory and retained even if battery is low or removed.	
Communication	USB 2.0 optically isolated	
Power Source**	2x1.5V AA-cell alkaline batteries	
Battery Life	100 hours to >45 days (dependent on storage rate/recording length)	
MECHANICAL		
Dimensions	4.95 x 2.75 x 1.28" (136 x 70 x 32mm) w/o Sensor	
Weight (with battery)	8.67 oz (245g)	
Sensor/Cable Length	Sensor: 6" (152mm) / Cable: 6 ft (2m)	
Maximum Conductor Size	Ø 1.77" (45mm)	
Case	UL94-V0	
Vibration	IEC 68-2-6 (1.5mm, 10 to 55Hz)	
Shock	IEC 68-2-27 (30G)	
Drop	IEC 68-2-32 (1m)	
ENVIRONMENTAL		
Operating Temperature	14° to 122°F (-10° to 50°C)	
Storage Temperature	-4° to 140°F (-20° to 60°C)	
Relative Humidity	Up to 85% at 95°F (35°C), Non-condensing	
Altitude	2000m	
SAFETY & ELECTRO-MAGNETIC COMPATIBILITY		
Safety Rating	EN61010-1; 600V CAT IV, 1000V CAT III; Pollution Degree 2	
Protection Degree	IP40	
Electro-Magnetic Compatibility	EN 61326-1; 07/1997 (+A1 10/1998, +A2 09/2001, +A3 05/2004)	
CE Approved	Yes	

MODEL	CL601
ELECTRICAL	
Channels	One
Input	Split CT – AC Current
Input Level	0 to 600Aac
Accuracy (50/60Hz)	0 to 5A: Unspecified 5 to 50A: $\pm(1\% \text{ of Reading} + 1A)$ 50 to 400A: $\pm(1\% \text{ of Reading} + 0.5A)$ 400 to 600A for duration $<10\text{min}$: $\pm(3\% \text{ of Reading} + 1A)$
Resolution	0.1A
Maximum Input Current***	600A $< 1 \text{ min}$
Sample Rate	64 samples/cycle
Storage Rate	Programmable from Recording 125ms to 1 per day
Storage Modes	Start/Stop, FIFO and Extended Recording Mode* (XRM™), Alarm
Recording Length	15 minutes to 8 weeks, programmable using DataView®
Memory	240,000 measurement (512KB). Recorded data is stored in non-volatile memory and will be retained even if battery is low or removed.
Communication	USB 2.0 optically isolated
Power Source**	2x1.5V AA (LR6) alkaline batteries
Battery Life	100 hours to $>45 \text{ days}$ (dependent on sample rate/recording length)
MECHANICAL	
Dimensions	9.25 x 4.0 x 1.63" (235 x 102 x 41mm)
Weight (with battery)	17.1 oz (485g)
Case	Polycarbonate UL94-V0
Jaw Opening	1 conductor - $\emptyset 1.42\text{"}$ (36mm); 2 conductors - $\emptyset 1.00\text{"}$ (25mm) each 2 bus bars - 50 x 5mm
Vibration	IEC 68-2-6 (1.5mm 10 to 55Hz)
Shock	IEC 68-2-27 (30G)
Drop	IEC 68-2-32 (1m)
ENVIRONMENTAL	
Operating Temperature	14° to 122°F (-10° to 50°C)
Storage Temperature	-4° to 140°F (-20° to 60°C)
Relative Humidity	up to 85% at 95°F (35°C), Non-condensing
Altitude	2000m
SAFETY & ELECTRO-MAGNETIC COMPATIBILITY	
Safety Rating	EN 61010-2-032; 300V CAT IV, 600V CAT III; Pollution Degree 2
Protection Degree	IP40
Electro-Magnetic Compatibility	EN 61326-1; 07/1997 (+A1 10/1998, +A2 09/2001, +A3 05/2004)
CE Approved	Yes

*This unique recording mode provides the opportunity to continuously record over long periods of time by reducing the storage resolution of the stored data and maintaining matching resolution for the newest data. Each time the memory fills up using XRM™, every other of the oldest stored samples is discarded making room for newer samples. This process continues until the recording is manually stopped.

**A memory backup capacitor provides backup power while the batteries are being changed. This backup capacitor will maintain the instrument for up to 10 seconds without batteries installed. After 10 seconds the date and time will need to be reset (data and configuration will be maintained). If the unit is connected to DataView® via a PC, the battery life is 100 hours regardless of the storage rate.

*** **Input level beyond this range may damage the instrument.**

Specifications are subject to change without notice.

OPERATION

4.1 LED Control Operation and Status Function

The ON/SLEEP state of the SLII can be determined by pressing the **PRESS** button for less than 0.5 seconds. If the instrument is ON, the status of the instrument will be shown by the LEDs. If the instrument is in SLEEP mode, all the status LEDs will light until the **PRESS** button is released. Once released, the status indication resumes.

If the instrument is in its sleep state, it can be woken up by pressing the **PRESS** button until all LEDs light. At this point, the button can be released to show the status of the instrument.

Control of the instrument is performed by pressing and holding the **PRESS** button until the control LED corresponding to the desired operation lights. Releasing the button when the desired control LED is illuminated results in the corresponding operation being performed.

When holding the **PRESS** button, each LED will light in sequence. Continuing to hold the **PRESS** button will result in all LEDs being off after the last LED lights. If you continue to hold the button down, the sequence will repeat with the first LED. Releasing the button after the last LED turns off and before the first LED turns on will result in no action being taken by the instrument. This provides a mechanism to cancel (or ignore) the button press.

The instrument will go into a sleep state to conserve power before a scheduled recording starts and will wake up shortly before a recording start time.

The **Control and Status Operation** of each LED is as follows:

GREEN LED		
CONTROL	Starts a Recording	
STATUS	Single-blink	Logger is in Standby Mode (and not recording)
	Double-blink	Logger is in Record Mode

ORANGE LED		
CONTROL	Stops a Recording	
STATUS	OFF	Logger is not in an Overload condition
	Single-blink	One or more inputs are in an Overload condition

YELLOW LED		
CONTROL	Clears the Alarm State (see § 4.6)	
STATUS	OFF	No alarm has been seen on any input
	Single-blink	At least one channel has seen an alarm at least once
	Double-blink	At least one channel is currently in an alarm condition
	Fast-blink	Armed to clear alarm indication

RED LED		
CONTROL	Erases the Memory (See § 4.7)	
STATUS	OFF	No data in memory
	Single-blink	Memory is partially filled
	Double-blink	Memory is full
	Fast-blink	Armed to erase memory
	Slow-blink	Erase memory in process

BLUE LED		
CONTROL	N/A	
STATUS	OFF	Battery voltage is above 2.2 volts
	Single-blink	Battery voltage is below 2.2 volts
	Double-blink	Indicates a recording is scheduled



Overload occurs when any input is 10% above its input range. When the battery voltage goes below 1.7 volt the instrument will shut down (terminating and saving the recording, if it is recording).

- **SLEEP mode:** The instrument enters the low power state if the button is not pressed for one minute. It will remain in this state until either the button is pressed or the internal clock reaches the start time for a scheduled recording.
- **RECORD mode:** The instrument enters the low power state between sample sets. The slower the storage rate, the greater the portion of time the instrument is in the low power state. Thus, the slower the storage rate, the longer the instrument can record.

4.2 Connecting the Simple Logger® II to a Computer



INSTALL DATAVIEW® BEFORE CONNECTING TO THE COMPUTER.

Connect the Simple Logger® II to a USB communication port on your computer. Refer to the computer manual to locate the USB port on your computer.

The logger can be connected to the computer during a recording session, however, an additional drain on the batteries will occur to support the active USB connection.



If all LEDs light instantaneously, the instrument was in **SLEEP** mode. Releasing the **PRESS** button will show the status (every 5 seconds).

- Connect the instrument to a USB port on your computer and establish communication with the instrument using DataView®. The logger will remain ON while a communication link with the SLII Control Panel is active (provided sufficient battery power is available during the communication session).

The instrument contains protection circuitry to prevent it from being turned on when the battery voltage is below 1.7V.

There are two thresholds for the battery voltage:

- **The first is used to indicate low battery.** The low battery indicator (Blue LED single blink) will blink when the battery voltage drops below 2.2V.

- **The second is used to determine when to terminate recording and turn the unit off.** The shutdown threshold is when the battery voltage drops below 1.7V.



Communication from the instrument to DataView® is disabled below 2.2V.

4.3 Recording Data



The Simple Logger® II must first be configured before a recording can be performed (see § 5.4).

Once a configuration is written to the instrument, the logger will no longer need to be connected to DataView® to start the scheduled recording.

When data is stored in the memory, the user may download the information onto a hard-disk (see § 5.9).



A scheduled recording will still start even if the logger is in sleep mode.

4.4.1 Starting a Recording Session



A new recording cannot be started if the memory is full.

1. Connect the instrument to the measurement source.
2. Make sure the logger is in **STANDBY** mode.
3. Press and hold the **PRESS** button. When the **START (GREEN)** LED lights up, release the button.
4. The GREEN LED double-blinks every 5 seconds when the logger is recording.



It may take a few seconds before the instrument starts recording. The recording status LED will single blink during this period.

4.3.2 Stopping a Recording Session

1. Press and hold the **PRESS** button. When the **STOP** (ORANGE) LED lights up, release the button.
2. The GREEN LED will change from a double-blink to a single-blink, indicating **STANDBY** mode.

The data will be retained, even if the instrument is in sleep mode. The recorded data is stored in Flash memory (maintained even in the absence of batteries). The recorded data may be downloaded to a computer.

4.4 Downloading Recorded Data

Recorded measurements stored in the instrument are transferred to a computer via the download command in the SLII Control Panel. For instructions on downloading data, refer to § 5.9.

4.5 Clearing Alarm Indication

Clearing alarms can be performed in the **STANDBY** or **RECORD** mode.

1. Press and hold the **PRESS** button. When the **ALARM** (YELLOW) LED lights up, release the button. The YELLOW LED will blink at a fast rate for a period of five seconds.
2. Press the **PRESS** button for another 0.5 second to complete the operation.



This does not clear any stored alarms, only indications. Stored alarms can only be cleared when memory is erased (see § 4.6).

4.6 Erasing Data from Memory

Erasing data from the instrument's memory can only be performed while in the STANDBY mode.

There are two ways to erase the memory:

Erasing the Memory using the PRESS Button:

1. Press and hold the **PRESS** button. When the **ERASE (RED)** LED lights up, release the button.

This will arm the instrument for an erase operation (when not in record mode). While armed to erase memory, the RED LED will blink at a fast rate for a period of five seconds.

2. Press the **PRESS** button for another 0.5 seconds to start the erase operation. During the erase operation the LED will blink once every second. Erasure takes about 20 seconds to complete.



If the button is not pressed within five seconds of arming, the erase operation will automatically disarm and memory will be maintained. For this reason, if you do not intend to erase memory, simply wait until the RED LED stops blinking at the fast rate.

Erasing the Memory using the SLII Control Panel:

1. Connect the instrument to the computer, then open the **SLII Control Panel**.
2. Select **Erase Memory** from the **Instrument Menu**.
3. A dialog box will appear asking to confirm the erasure of the instrument's memory. Select **Yes** to confirm or **No** to cancel the operation.



Erasing the memory will also clear any stored alarms.

4.7 Data Storage

The logger captures Trend measurements.

The following are definitions of terms used in this section:

Input Channel: Source for the measurement channel of the instrument.

Measurement Channel: Measurement of input. This can be a simple direct measurement, the result of complex mathematical operations on a single or multiple input, or other channels.

Sample Rate: The rate at which the instrument measures inputs.

Storage Rate: The rate at which channel measurements are stored.

4.7.1 Trend Measurements

The logger stores the measurement of each of the inputs. In addition, the user can define the storage rate, recording period and measurement format using the **Configure Instrument** dialog box in the SLII Control Panel software. Trend measurements are stored at this fixed storage rate.



EXAMPLE: AC loggers store TRMS calculation of a single line cycle. DC loggers store the conversion result of each input.

4.8 Logger Operation

When the instrument is in STANDBY mode, the following occurs (provided there is sufficient battery voltage and no data is stored in the instrument's memory):

- The GREEN LED single-blinks every 5 seconds. (STANDBY mode is active and the logger is not recording).
- The RED LED is OFF, indicating there is no data in memory.
- The **PRESS** button is used to Start/Stop a Recording Session.
- If the **PRESS** button is not pressed for a period of one minute, the instrument will enter SLEEP mode and wait for either another button press or the recording start time to arrive (if a recording is scheduled). While in SLEEP mode, the LEDs will not blink.
- A button press of 0.5 seconds will return the unit back to the normal STANDBY mode.

4.8.1 Recording with Memory Cleared

When a recording starts, the logger will continue to record until one of the following occurs:

- The Session is complete.
- The Memory is full and the recording mode is Start/Stop or Alarm.
- The **PRESS** button is pushed until the STOP (ORANGE) LED lights up and is released before the next LED lights.
- The Stop Recording command from the SLII Control Panel is sent to the unit.
- The battery voltage falls below 1.7V.

4.8.2 Recording with a Partial or Full Memory

If the RED LED is double-blinking every 5 seconds, the memory is full and must be erased before any further recording can be performed.

If the RED LED is single-blinking every 5 seconds prior to starting a New Recording Session, the memory is partially full.

To save, clear or check memory availability, use the Simple Logger® II Control Panel software.

There may be instances where the GREEN LED is also double-blinking every five seconds indicating that the logger is still recording. The user can choose to stop the Recording Session and download the session and/or erase the memory.



The logger memory cannot be erased while in the Record mode. The recording must be stopped first.

4.8.3 Memory Filled During Recording Session (Start/Stop Mode)

If the logger is recording using the Start/Stop mode and memory is filled before the Recording Session has finished, the session will end.

The following happens after the **PRESS** button is pushed for 0.5 second:

- The GREEN LED single-blinks (standby mode).
- The RED LED double-blinks (full memory).

At this time:

- The memory can be downloaded and erased.
- A new recording can be started or scheduled once memory is erased.



If in either the XRM or FIFO mode, the recording will continue even after memory becomes full. Memory will be freed to make room for new samples. The method of freeing memory will depend on the recording mode.

4.8.4 Battery Power Insufficient for a Full Recording Duration

If the battery voltage drops below 1.7V, the following will occur:

- The Recording Session will terminate.
- The Data will be saved.
- The GREEN and RED LED will turn OFF.

The logger continues to record until the battery voltage drops below 1.7V. Pressing the **PRESS** button will not show the status of the instrument. The battery voltage may rise slightly after the unit turns itself off. In this event, the unit may turn on momentarily as a result of a button press.

The batteries must be replaced before the recorded session(s) can be downloaded from the instrument.



Replacing the batteries while the unit is in SLEEP mode will not result in the loss of data memory. The internal backup capacitor will maintain the clock and memory while the main batteries are being replaced. If the battery level falls below the usable level or if the batteries have been removed for an extended period of time, the clock time will be lost. However, the recorded memory will be maintained.

4.8.5 Recording Session has Ended

The logger will be in STANDBY mode if one of the following occurs:

- The session terminates due to recording end time being reached.
- The recording in START/STOP mode fills the memory.
- The user terminates the session by pressing the **PRESS** button until the STOP (ORANGE) LED lights up and releasing the button before the next LED lights, or issues a Stop Recording command from the Simple Logger® II Control Panel.

The logger is now ready for a New Session or Download. Pressing the **PRESS** button until the START (GREEN) LED lights up and releasing the button before the next LED lights, will start a New Session depending on the available memory.

4.9 Event Logger Operation (Model L404 Only)

The Model L404 monitors up to four channels for the occurrence of events and stores information about each event. The rate at which each input is tested for the event status is defined by the sample period.

Events that are shorter in duration than the period between sampling can potentially be missed. For this reason the sample period should be chosen to be at least twice the fastest event rate (e.g. An event being monitored is expected to occur no faster than once per minute. The sample period should then be set to at least every 30 seconds).

An event starts when the input goes low and ends when the input goes high. For contact closure this would be when the contact is closed and then opened. The logger records the time the event started and the duration of the event. The accuracy of the start time and duration is limited to the rate at which the inputs are tested (as defined by the sample period).

An option to invert the displayed graph is available in the scales tab of the instrument configuration window. This allows for setting the display to show a high as a low for all inputs. This is the default state and will be shown as normally low until an event occurs.

As mentioned, events start and end when the input goes low and when it goes high (regardless of the graph invert option). For voltage measurements this is when the voltage drops below 0.7V and goes above 0.8V. For contact (relay) closures this is when the contact closes and when it opens. Overload will be displayed when the input rises above 5.5V.

The logger will store one event, which means that if there is no change at the input of the instrument, it will not store any data until the next event cycle occurs. This happens when the instrument sees the changes at an input, as previously described.

If the expected event rate is 1s, then it would be necessary to set the sample rate faster than once per second in order to capture the events. As mentioned previously, the timing accuracy of the captured event is dependent on the sample rate. The faster the sample rate, the higher the timing accuracy.

Minimum duration of an event will need to be the duration of the sample rate such that if the sample rate is 125mS, then the pulse will need to be at least 125mS to be certain that the logger will capture the event.

4.9.1 Sample Event Capture

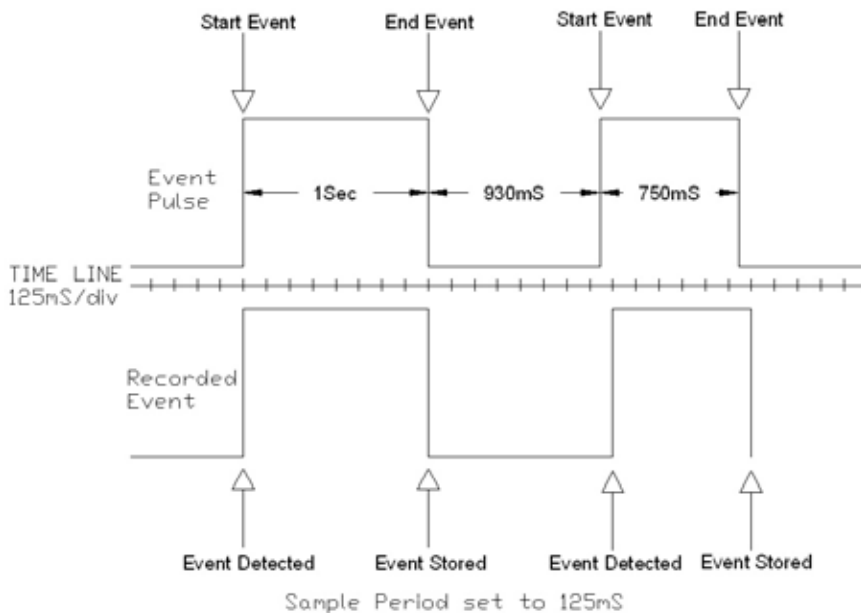

Figure 4-1

The above example assumes that the “Invert display polarity (event displayed as a high)” is selected from the scales tab of the configuration (default setting).

4.9.2 Application Examples

Rain Gauge:

Each time a tipping bucket fills and tips, a contact opens indicating that 0.1 inch of rain has filled the bucket. Attaching the L404 to this contact allows recording of both the number of times the bucket has tipped, as well as the totalization of rainfall during the recording.

In the configuration menu, the user has the ability to program both the weight and value of an event pulse. In this case, the weight would be 0.1 and the units would be in inches.

In Figure 4-2, eight tips occurred for a total of 0.8 inches of rainfall.

Sequencing:

In a processing plant it has been determined that timing on several positions is out of specification. The service staff needs to know the sequence of valve opening and closing, and the duration of each, to correct the problem. The L404 can be connected to four outputs in the process and keep track of the time and duration of each opening and closing, thus providing the technician with the data they need to solve the sequence issue.

In the example below we can see that the valve 1 opened and closed several times during a one minute period, but valves 2, 3 and 4 did not respond.

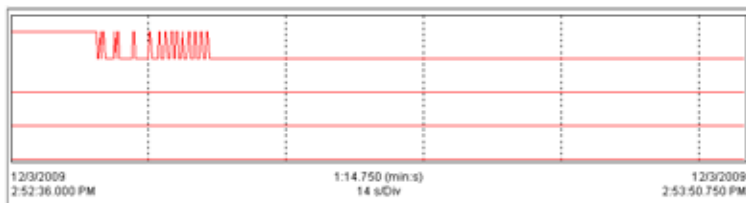

Figure 4-2

4.10 Reset Switch Operation



CAUTION: Risk of electric shock. Disconnect the unit from any input source before opening the rear cover. Electrical shock may occur with damage to the user and/or the instrument.

Resetting the instrument takes about 10 seconds, at which time the instrument will be non responsive.

For Standard Units:

The **RESET** button (see § 2.2.1 for reference to the location), resets the CPU and is located under the top cover. To access this button, remove the battery compartment cover, remove the four screws holding the two halves of the case together. The reset button is located on the exposed PCB near the input(s).

For Model CL601:

To access the **RESET** button (see § 2.2.2 for reference to the location), remove the battery compartment cover. The button is located to the left of the batteries.



It is recommended to only press the **RESET** button when the logger stops responding to a normal press button control when not connected to Data-View®. It is not recommended to reset the instrument when the logger is recording, downloading or being configured.

If the logger is not responding to a button press, make sure the unit has sufficient battery power. If the battery voltage is below 1.7V, the unit will not respond to a button press. In this condition, pressing the **RESET** button will not restart the unit.

It is recommended to download any desired session and erase the memory before starting a new recording.



The resumption of the logger operation in the above situations assumes that the **RESET** button cleared the fault(s). The logger will not resume normal operation if the fault condition still exists. The instrument will try to recover normally. However, under certain conditions, the clock and memory full state may reset, meaning that the memory is marked as full and the clock date/time is lost.

4.11 Flash Upgrade Switches

The Flash Upgrade Switches (see § 2.2.1 and 2.2.2 for reference to the location) are used to recover from a failed flash upgrade.

Both switches should be turned to the “ON” position in order to flash upgrade the instrument using the “Fail Safe” method of upgrade from within the “SLIIFlashUp1xx” utility program.

Both switches **MUST** be set to the “OFF” position once the upgrade has completed.



Failure to set both Flash switches OFF after the upgrade will prevent the instrument from operating properly and deplete the batteries.

SOFTWARE INSTALLATION

5.1 Installing DataView®



DO NOT CONNECT THE INSTRUMENT TO THE PC BEFORE INSTALLING THE SOFTWARE AND DRIVERS.

Minimum Computer Requirements:

- Windows XP / Windows Vista & Windows 7/8 (32/64 bit)
- 256MB of RAM for Windows XP
1GB of RAM for Windows Vista & Windows 7/8 (32 bit)
2GB or RAM for Windows Vista & Windows 7/8 (64 bit)
- 80MB of hard disk space (200MB recommended)
- USB port

Windows is a registered trademark of Microsoft Corporation in the United States and other countries.

USB Flash Drive Install

1. Insert the USB stick into an available USB port (wait for driver to be installed).
2. If Autorun is enabled then an AutoPlay window should appear as shown.

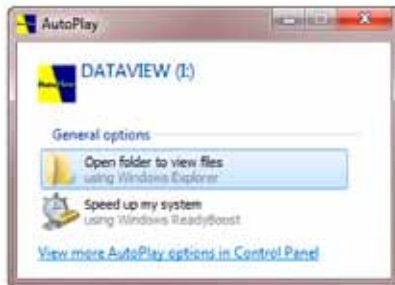



NOTE: If Autorun is disabled, it will be necessary to open Windows Explorer, then locate and open the USB stick drive labeled “DataView” to view the files on the drive.

3. In the AutoPlay window, select **Open Folder to view Files**.
4. Double-click on **Setup.exe** from the opened folder view to launch the DataView setup program.



NOTE: If installing onto a Vista based computer the **User Account Control** dialog box will be displayed. Select the **Allow** option to proceed.

5. A **Set-up** window, similar to the one below, will appear.

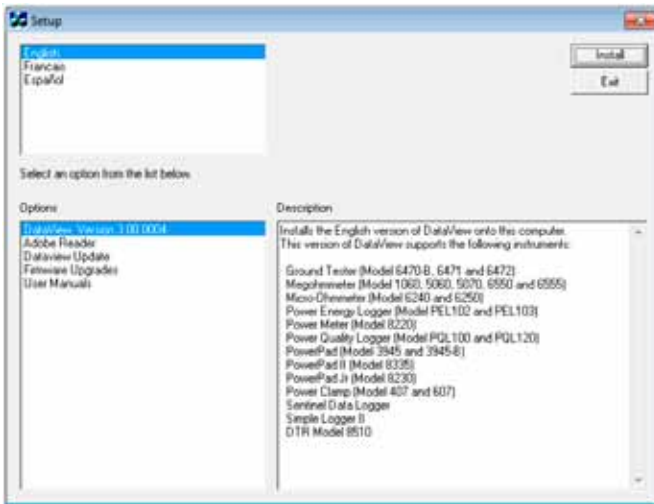

Figure 5-1

There are several different options to choose from. Some options^(*) require an internet connection.

- **DataView, Version x.xx.xxxx** - Installs DataView® onto the PC.
- ***Adobe Reader** - Links to the Adobe® website to download the most recent version of Adobe® Reader to the computer. *Adobe® Reader is required for viewing PDF documents supplied with DataView®.*
- ***DataView Updates** - Links to the online DataView® software updates to check for new software version releases.

- ***Firmware Upgrades** - Links to the online firmware updates to check for new firmware version releases.
 - **Documents** - Shows a list of instrument related documents that you can view. Adobe® Reader is required for viewing PDF documents supplied with DataView®.
6. **DataView, Version x.xx.xxxx** option should be selected by default. Select the desired language and then click on **Install**.
 7. The **Installation Wizard** window will appear. Click **Next**.
 8. To proceed, accept the terms of the license agreement and click **Next**.
 9. In the **Customer Information** window, enter a Name and Company, then click **Next**.
 10. In the **Setup Type** window that appears, select the “**Complete**” radio button option, then click **Next**.
 11. In the **Select Features** window that appears, select the instrument’s control panel that you want to install, then click **Next**.



NOTE: The **PDF-XChange** option must be selected to be able to generate PDF reports from within DataView®.

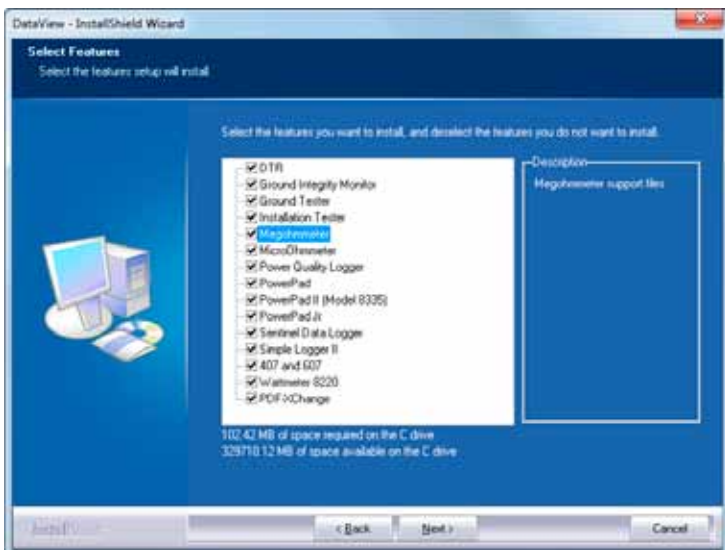

Figure 5-2

12. In the **Ready to Install the Program** window, click on **Install**.

13. If the instrument selected for installation requires the use of a USB port, a warning box will appear, similar to Figure 5-3. Click **OK**.



Figure 5-3



NOTE: The installation of the drivers may take a few moments. Windows may even indicate that it is not responding, however it is running. Please wait for it to finish.

14. When the drivers are finished installing, the **Installation Successful** dialog box will appear. Click on **OK**.
15. Next, the **Installation Wizard Complete** window will appear. Click on **Finish**.
16. A **Question** dialog box appears next. Click **Yes** to read the procedure for connecting the instrument to the USB port on the computer.



NOTE: The Set-up window remains open. You may now select another option to download (e.g. Adobe® Reader), or close the window.

17. **Restart** your computer, then connect the instrument to the USB port on the computer.
18. Once connected, the **Found New Hardware** dialog box will appear. Windows will complete the driver installation process automatically.

Shortcuts for DataView® and each instrument control panel selected during the installation process have been added to your desktop.



NOTE: If you connected your instrument to the computer before installing the software and drivers, you may need to use the **Add/Remove Hardware** utility to remove the instrument driver before repeating the process.

5.2 Opening the Control Panel

To open the Simple Logger® II Control Panel:

- Double-click the **Simple Logger II Icon** that was created during installation, located on the desktop.
- The **Connection** window will appear (see Figure 5-4).



NOTE: When connecting using the Simple Logger II icon and only one Simple Logger II is connected to the computer, it will be selected and a connection will be established automatically.

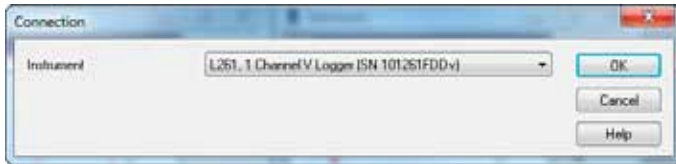

Figure 5-4

The **Connection** window specifies the connected instrument in the communications drop-down list.

If multiple units are attached, select the desired unit with its associated serial number from the drop-down list.

Once the desired instrument has been selected, click **OK** and the **Simple Logger® II Control Panel** and **Real-time** windows will be displayed (see Figure 5-5).



NOTE: The default layout can be changed by moving and resizing each window (see § 5.6 - Resizing and Saving Window Layouts).

TIP: Click on the **Arrange Window** icon  located at the top right of the toolbar to expand and arrange all the windows evenly, all at once.

TIP: For complete instructions and information on using **DataView®**, refer to the **Help Menu** within the software.

5.3 Using the Control Panel

The **Control Panel** is used for instrument operation and configuration.

To open the Control Panel either click on the **Control Panel** option from DataView's main **Instrument** menu or double-click on the Simple Logger® II desktop icon.

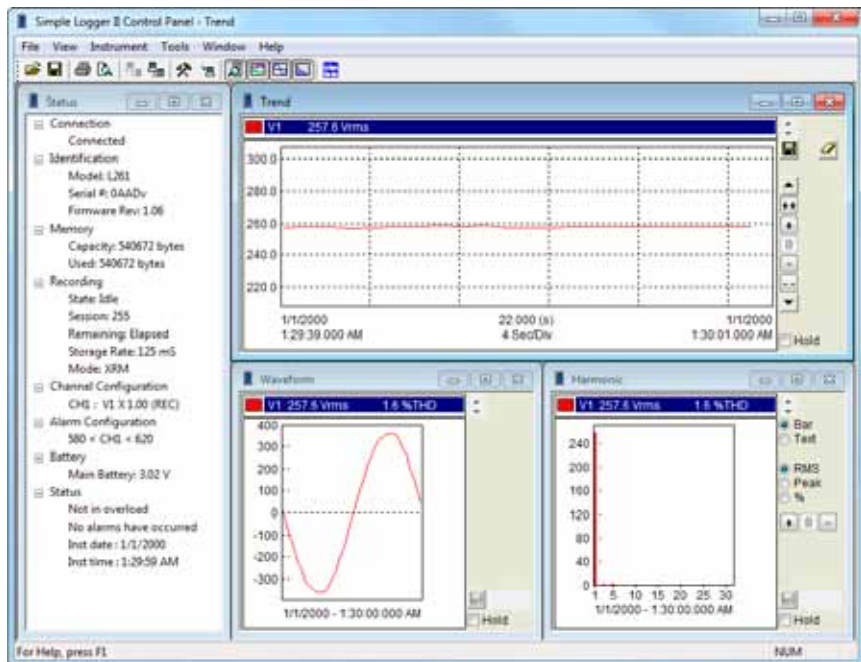

Figure 5-5

The main menu at the top of the screen lists the following commands:

File

Load Layout - loads a real-time window layout.

Save Layout - saves the current real-time window layout.

Open Configuration - allows the selection of, and opens, a Simple Logger II configuration file.

Start Recording Real-time Data - stores real-time trend data into a specified database.

Save Trend Data - When selected, the user will be asked to specify a data file name and the trend measurements currently displayed in the trend window will be saved in the specified database file.

Print - prints the selected real-time window.

Print Preview - provides a preview of the real-time window to be printed.

Print Setup - displays a Print Setup window allowing you to select a destination printer and change various printing options.

Exit - closes the control panel.

View

Trend - opens a real-time trend graph window.

Waveform - opens a real-time waveform window.

Harmonic - opens a real-time harmonic bar graph window.

Status - opens a real-time window displaying status information about the connected Simple Logger® II.

Instrument

Connect - establishes a connection.

Disconnect - closes a connection.

Configure - displays the instrument configuration window.

Download - downloads recorded data stored in the Simple Logger® II.

Start/Stop Recording - if the instrument is not recording, this menu option will read as Stop Recording and when selected sets the recording start time to now. The stop time will be set to the current time plus the original recording duration. If the instrument is recording, this menu option will read as Stop Recording and will terminate the recording when selected.

Set Clock - when selected, the Date/Time dialog box is displayed allowing you to change the date and time in the connected instrument.

Erase Memory - erases all recorded data stored in the instrument.

Clear Alarms - resets the alarm indication on the instrument, as well as in the status window of the Control Panel.

Tools

Channel Trace Colors - allows the user to specify the default colors to be assigned to graph traces associated with specific trend measurements.

Input Trace Colors - allows the user to specify the default colors to be assigned to graph traces associated with specific hardware input channels.

Decode Data File - allows the user to load a download.dat file.

Default Templates - when selected it allows the user to specify a different default template when creating DataView® reports from the downloaded recordings.

Window

Cascade - arrange all windows into a stack, with each window offset slightly.

Tile - display all windows equally sized without overlapping.

Arrange Windows - arrange the real-time windows into a default layout based on the size of the main control panel window.



NOTE: In addition, a list of open real-time windows is displayed at the bottom of the Window menu. Selecting one of these options will activate the associated real-time window. This is useful when other windows hide a desired window.

Help

Control Panel - display the main Control Panel help topic.

Contents - display the help contents dialog box.

How To - display the How To help topic.

About - displays the About dialog box.

5.4 Configuring the Simple Logger® II

To Configure the Simple Logger® II, perform the following steps:

1. Open the Simple Logger® II's **Control Panel** and connect to an instrument (refer to § 5.2 if you are unsure how to open the Control Panel).
2. Next, select **Configure** from the **Instrument** menu and the Configure Instrument dialog box, similar to Figure 5-6, will be displayed.



NOTE: The configuration of an instrument cannot be changed while a recording is in progress. You must click on Stop Recording before proceeding.

The first tab (**Recording**) allows you to define the Storage Rate and Recording Mode.



Figure 5-6

This **Recording** tab allows you to define:

Storage Rate: rate at which sampled data is stored in the recording.

Recording Period: duration of the recording.

Start Time of Recording: time to start and end the recording.

Schedule Recording: this option must be selected to specify the start and end date/times of a scheduled recording.

Record Now: forces a recording to start as soon as the configuration is applied (date/time fields are grayed when this is selected).

Reset Date/Time: sets the start and end date and time.

Erase: pressing this button will erase all measurements and alarms that are stored in memory.

Storage Mode: how to handle data storage when memory becomes full.

- **Start/Stop** - will cause the recording to start at the specified time and continue until memory becomes full or the recording end time is reached (which ever occurs first).
- **FIFO** - will cause the recording to start at the specified time and continue until the recording end time is reached. If memory becomes full before the end time, the oldest samples are discarded until the recording terminates. This results in a duration that is dependent on the amount of memory and the storage rate.

(e.g. if the storage rate and available memory allows for an 8 hour recording, and a 24 hour period was selected to record, the samples stored will cover the last 8 hours in that 24 hour period.)

- **XRM™** - will cause the recording to start at the specified time and continue until the recording end time is reached. If memory becomes full before the end time, every other sample is discarded (freeing up half of the memory), the storage rate is cut in half and storage continues. This repeats until the recording end time is reached. This results in a recording that contains samples covering the desired recording period with the sample rate adjusted to accommodate that period.
- **Alarm** - Trend measurements are saved only while one or more of the measurement channels are in alarm. The Alarm Mode requires that the alarms for one or more channels are enabled and configured. This recording mode terminates when the recording end time is reached or when memory becomes full. See the Alarms configuration tab for configuring alarms.

Starting Mode: how to start a recording, without regard for storage rate or synchronized to the storage rate.

- **Normal** - will cause the recording to start at the specified starting time without regard for storage rate.

- **Synchronous** - will cause the recording to start synchronized to the storage rate.

For example, if the storage rate is set to once every 5 seconds, the recording will start at 0, 5, 10, 15, 20, 25, 30, 35, 40, 45, 50 or 55 seconds on the minute. The recording will start at the next synchronous starting point after the specified starting time. If the start time falls at a synchronous boundary then the recording will start at the specified time. The start time is different from the specified time only when it is not at a synchronous boundary.

Set Clock: displays the Date/Time dialog box for setting the date/time in the instrument.

Measurement Setup: lists the channels available to be recorded.

Record: if more than one channel is listed in the measurement setup, you can enable/disable the recording of each channel by selecting/deselecting the Record checkbox. At least one channel must be selected for recording.

5.4.1 Setting Recording Options

Start/Stop Recording Mode

Select the **Start/Stop** radio button.

Recording Start:

Specify a start date and time by performing one of the following:

- Select the **Record Now** check box. Enabling this option will cause the instrument to start to record when the configuration is written to the instrument.
- Enable the Schedule recording check box option, then enter the start date and time in the associated edit boxes.

Recording End:

Specify an end date and time by performing one of the following:

- Select a time under **Recording Length**. This will set the **Recording End** date and time to the Recording Start date and time plus the selected time duration.
- Enable the Schedule recording check box option, then enter the end date and time in the associated edit boxes.

FIFO Recording Mode

The **FIFO** mode operates much like the **Start/Stop** mode with the exception that the recording does not stop when memory becomes full.

When this happens, the oldest sample set is discarded to make room for the new sample set. The instrument will record the most recent samples until the user stops it or the recording end time is reached.

Select the **FIFO** radio button.

Recording Start

Specify a start date and time by performing one of the following:

- Select the **Record Now** check box. Enabling this option will cause the instrument to start to record when the configuration is written to the instrument.
- Enable the Schedule recording check box option, then enter the start date and time in the associated edit boxes.

Recording End:

Specify an end date and time by performing one of the following:

- Select a time under **Recording Length**. This will set the **Recording End** date and time to the Recording Start date and time plus the selected time duration.
- Enable the Schedule recording check box option, then enter the end date and time in the associated edit boxes.

XRM™ Recording Mode

The **XRM™** mode operates much like **Start/Stop** mode with the exception that the recording does not stop when memory becomes full.

When this happens, every other sample is discarded, memory is compacted and storage continues at 1/2 the storage rate. This mode of recording adjusts the storage rate in order to keep the recording going. The instrument will continue to record until the user stops it or the recording end time is reached.

Select the **XRM™** radio button.

Recording Start

Specify a start date and time by performing one of the following:

- Select the **Record Now** check box. Enabling this option will cause the instrument to start to record when the configuration is written to the instrument.

- Enable the Schedule recording check box option, then enter the start date and time in the associated edit boxes.

Recording End:

Specify an end date and time by performing one of the following:

- Select a time under **Recording Length**. This will set the **Recording End** date and time to the Recording Start date and time plus the selected time duration.
- Enable the Schedule recording check box option, then enter the end date and time in the associated edit boxes.

Alarm Recording Mode - Trend measurements are saved only while one or more of the measurement channels are in alarm. This storage mode requires that the alarms for one or more channels are enabled and configured. This recording mode terminates when the recording end time is reached or when memory becomes full. See the Alarms configuration tab for configuring alarms.

Select the **Alarm** radio button.

Recording Start

Specify a start date and time by performing one of the following:

- Select the **Record Now** check box. Enabling this option will cause the instrument to start to record when the configuration is written to the instrument.
- Enable the Schedule recording check box option, then enter the start date and time in the associated edit boxes.

Recording End:

Specify an end date and time by performing one of the following:

- Select a time under **Recording Length**. This will set the **Recording End** date and time to the Recording Start date and time plus the selected time duration.
- Enable the Schedule recording check box option, then enter the end date and time in the associated edit boxes.

Common Recording Options

Read - reads the configuration inside the attached Simple Logger® II and resets the field options based on the instrument's current configuration.

Load - allows the user to select a previously saved configuration file.

Save - saves the current configuration to a file.

The **Configure Instrument** window also contains a memory status area. This area displays the amount of memory used, the amount of available memory and the amount of memory required for the selected configuration.

5.4.2 Setting Scales Options

The second tab "**Scales**" (Figure 5-7) allows you to configure a channel. First select the desired channel from the list, then specify the following options for that channel:

Input scale - for inputs that have fixed scales this option is disabled. For inputs that are not fixed (current clamps for example) you can specify a scale for the input. For example 1V = 1000A.

Offset - for instruments that allow a user offset this will be displayed. The offset is applied to measurement values when measurements are downloaded from the instrument. This value can be positive or negative.

Linearity - for instruments that allow a user specified linearity adjustment this control will be displayed. The linearity adjustment allows you to specify different multipliers for different ranges of measurements. The linearity is applied to measurement values when measurements are downloaded from the instrument.

Units - for instruments that allow user specified measurement units, this control will be displayed. It allows you to over-ride the default measurement units of the instrument.

Temperature Units - this option is only available and displayed when configuring a TC logger. This option allows you to select between the three temperature units (Celsius, Fahrenheit and Kelvin), in addition it allows you to display the raw voltage measurement of each input.

TC Type - this option is only available and displayed when configuring a TC logger. It allows you to select between the Thermocouple types supported by the instrument. This selection will apply to all TC inputs. Multiple TC types cannot be used at the same time with the Simple Logger II.

Filter - this option is only available and displayed when configuring instruments that support input filtering. It allows you to select the level of filtering (averaging) of measurements. Filtering is performed by averaging the last x values measured on an input. Next to each filter name (in parenthesis) is the number of samples averaged. A Filter of None provides no filtering and simply results in individual measurements being stored.

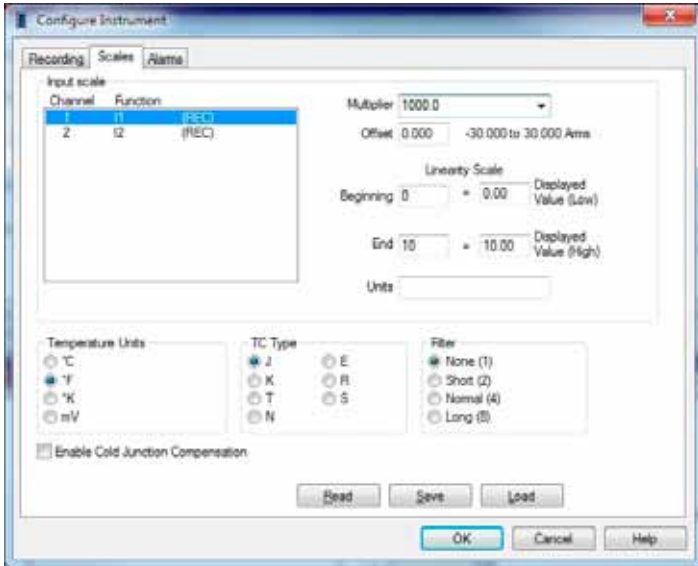

Figure 5-7



NOTE: Not all options shown may be available. The Scale tab varies in options depending on the model of the logger connected.

5.4.3 Setting Alarm Options

The third tab (**Alarms**) allows you to define:

Alarms - each channel is configured independent of each other. Only channels selected to be recorded are available for alarm testing. Alarms are set by selecting the desired channel, selecting the alarm type and specifying the alarm limits. Selecting the **Inclusive** check box will trigger the alarm if the channel level is equal to the specified limits.

Example: If you select the **Above** upper limit alarm type and don't select **Inclusive**, the alarm is triggered if the measured value is greater than the specified upper limit. Selecting **Inclusive** will cause the alarm to be triggered if the measured value is greater than or equal to the specified upper limit.



NOTE: Each channel is independent and can have different alarm settings.

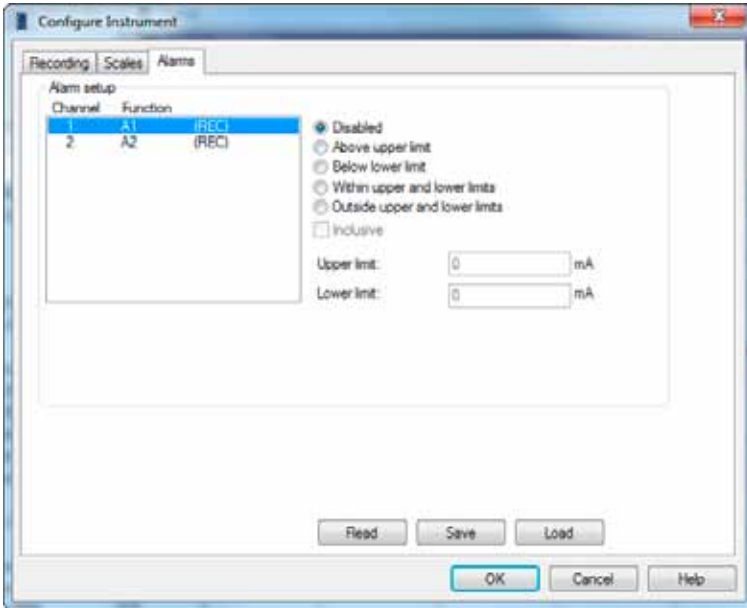

Figure 5-8



NOTE: The values measured on current input models are limited to 1.1Vrms max before the instrument displays an overload.

If you want to start the recording, click on the **Recording** tab, then select **Record Now** followed by the **OK** button. This will write the configuration to the instrument and begin a recording (provided enough memory is available).

To save the configuration to the instrument and close the dialog box, click the **OK** button.

Selecting the **Cancel** button will close the Configure Instrument dialog box discarding the configuration changes.

Selecting the **Help** button will display the associated help topic.

5.4.4 Configuring and Recording Data

The following is intended as an example.

You will configure the instrument to measure (and record) at a storage rate of **5 Seconds** over a recording period of **15 minutes** with no alarms.

Note: The instrument's clock should be set to the proper time as the clock may vary due to time zones.

1. If a recording is active, stop it by selecting the **Stop Recording** menu option.
2. Open the **Configure Instrument** window and select the **Recording** tab to display the Recording page.
3. Select **5 Seconds** from the Storage rate drop-down list (you may need to use the vertical scroll bar to see this option).
4. Select the **Start/Stop** recording mode.
5. Select a 15-minute recording duration by selecting the **15 Minutes** option from the **Recording period** drop-down list.

At this point the Recording page should look similar to Figure 5-9.

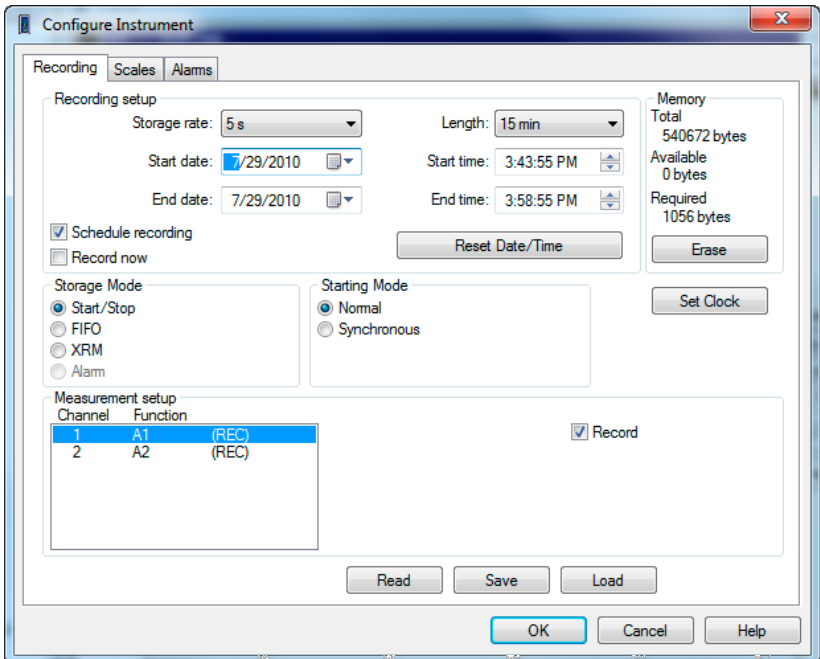

Figure 5-9

6. Select the **Scales** tab to display the Scales page.
7. Select the **Input scale**, if available.
8. Select the **Alarms** tab to display and configure Alarm settings.
9. To save the configuration before recording, see § 5.4.5.
10. To record, click on the **Recording** tab and check the **Record Now** checkbox, then press **OK**. This will write the configuration to the instrument and begin a recording (provided enough memory is available in the instrument).

5.4.5 Saving and Recalling a Configuration

Open the Configure Instrument window by selecting **Configure** from the **Instrument** menu.

To Save the Current Configuration to Disk:

- Select the **Save** button. The **Save As** window will be displayed.
- Specify a name for the file and type it into the **File name** field, then specify a location to save it to.
- Once the file name and directory have been specified, select the **Save** button.

To Recall (Load) a Saved Configuration from Disk:

- Select the **Load** button. The **Open** window will be displayed.
- Specify the name of the file by typing it into the **File name** field, or select it from the location where the configuration was originally saved.
- Once the file name and directory have been specified, select the **Open** button. The configuration will be read from disk and the Configure Instrument window will reset accordingly.

Selecting the **Read** button will read the configuration in the attached instrument and reset the dialog fields, accordingly.

5.5 Displaying Real-time Status Information

Real-time data and instrument status is displayed in the **Control Panel**.

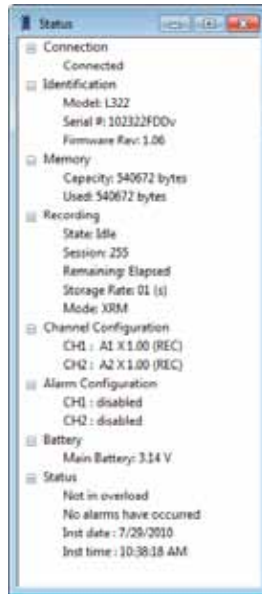

Figure 5-10

Connection Status - shows if instrument is connected/disconnected.

Instrument Identification:

Model - instrument's model identification number.

Serial # - instrument's serial identification number.

Firmware Rev - firmware revision of the attached instrument.

Memory:

Capacity - total amount of memory available for recorded data.

Used - amount of recording memory currently used.

Recording:

State - instrument's recording state (Idle or Active).

Session - number of sessions currently stored in the instrument.

Time Remaining - amount of time remaining for the current recording session (if one is active).

Recording Storage Rate - time between storage of measurement data.

Recording Mode - storage mode (Start/Stop, FIFO, XRM™ or Alarm).

Configuration:

Channel 1 and 2 - shows the configuration of each channel.

Battery:

Main battery - voltage of the main battery.

Status:

Overload - displays the overload status.

No alarms have occurred - displays the alarm status.

Inst date/time - displays the date and time read from the instrument.

5.6 Resizing and Saving Real-time Window Layouts

A quick and easy way to arrange window layouts is done by clicking the **Arrange Windows** icon  in the toolbar. This will automatically arrange the window layout for you.

Real-time windows can also be resized and arranged to suit your needs by using the mouse pointer. To move a window, simply click and hold on the title bar, then drag to the desired location. To resize a window, click and drag the corner of the window.

Once you have all of your windows in a desired location, you can save your layout for future use.

To Save a Layout:

- Go to **File > Save Layout**. Type in a name for the layout and select the folder that you wish to save it in. Click on **Save**.

To Load a Layout:

- Go to **File > Load Layout**. Locate and select a previously saved layout file. Click on **Open**.

5.7 Displaying Real-time Graphs and Text

The following real-time windows can be opened and closed from the **View** menu or the toolbar.

Waveform (model dependent): The Waveform window displays line cycle snapshots. This window displays the actual waveform relative to time.

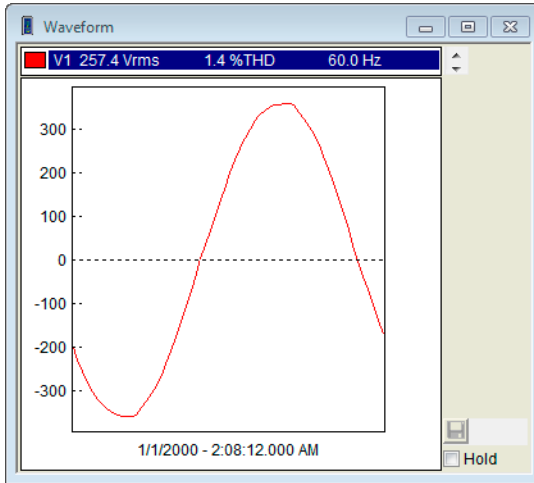

Figure 5-11

Harmonic (model dependent): The Harmonic window shows the harmonic content of an associated line cycle using a bar graph or tabular textual summary. Depending on the selected radio button (Bar or Text).

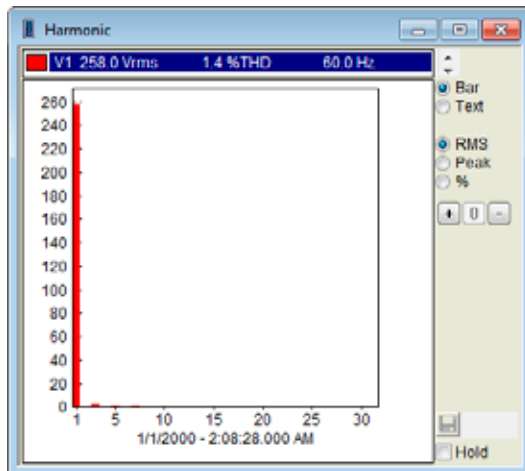

Figure 5-12

Trend: The Trend window shows measurements (sample points) over a time period.

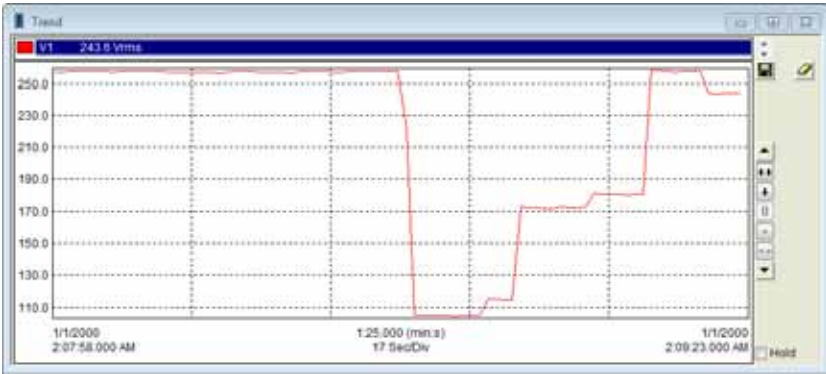

Figure 5-13

Displayed at the top of these windows is a list of available channels. Clicking on an entry will display the corresponding channel. You can select one or more channels by using the **Ctrl** or **Shift** keys while making a selection.

The real-time update can be paused by clicking the **Hold** check box at the bottom right of the window. The automatic update will stop until the Hold check box is deselected. Graph magnifications can be increased, reset and decreased by selecting the **++**, **+**, **0**, **-** and **--** buttons.

5.8 Saving Real-time Measurements

Real-time data received from an instrument can be saved directly into a recording session database. This differs from the process of downloading and saving recorded data in that the measurements are stored on the computer as the instrument measures them. These measurements are not necessarily being stored within the instrument. However, the instrument may be configured to record at the same time real-time measurements are being received from the instrument. In which case, two copies of the measurements will be stored. One copy is stored on the local computer and the other in memory within the instrument.

In addition, you can save waveform snapshots (when available) via the Control Panel where the instrument does not capture and store waveforms. This provides functionality that extends the capabilities of the Simple Logger® II.

To Save Real-time Measurements:

1. To begin recording real-time measurements, select the **Start recording real-time data** option from the **File** menu. When the Start recording real-time data option is selected, a dialog box will be displayed asking for the name of the database to save the measurements into.
2. Specify the name of the database file by typing it into the **File name** field or by selecting one from the displayed list. Next, select the desired location to save the file. Select **Save** to save the file or **Cancel** to return to the Control Panel.
3. If **Save** was selected, the **Session Properties** window displays.



Figure 5-14

The Session Properties dialog allows you to specify Operator, Site and Custom parameters that are to be saved with recorded data. These parameters are used when generating reports.

The Operator and Site tabs allow you to maintain lists of operators and sites, saving you time when specifying parameters for reports.

On the left of the Operator and Site tabs is the list of previously defined Operators and Sites. On the right of the Operator and Site tabs is the individual parameters that will be saved in an associated database. Only a single set of operator and site fields are saved in the recording database.

The Custom tab contains a list of user defined parameters. Along side each user defined parameter is a check box. Items that are checked will be added to an associated database. Only a single set of Custom parameters can be maintained (unlike the Operator and Site lists). The Custom

tab allows you to specify any user defined parameters (in addition to the comments field of the Site tab) that are to be used in displaying a report.

4. Type the appropriate information into the fields, then click **OK**.
5. Measurement data will be saved until the **Stop recording real-time data** option is selected from the File menu. When you stop recording real-time data, you will be asked if you want to open the database.
6. Answering **Yes** will bring the main DataView® window to the foreground and the **Create Report from Template** window will be displayed.

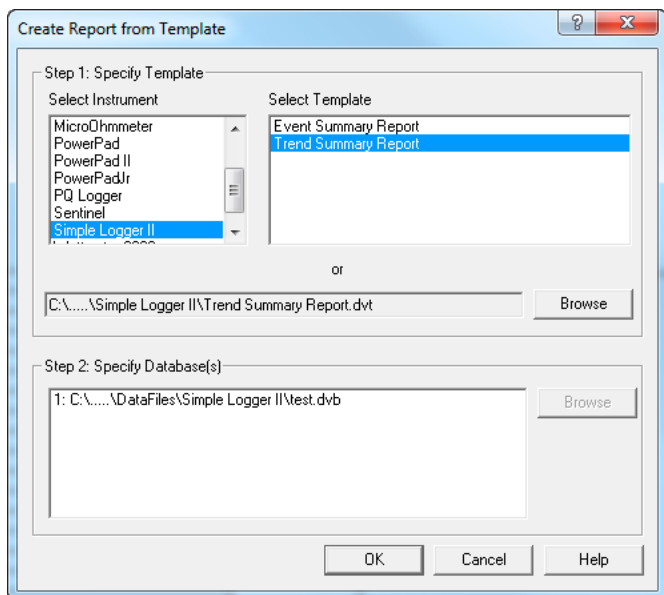

Figure 5-15

This window allows the user to specify a template for the database that was just downloaded and saved. A suggested template will be selected. Either accept this template or select another one.

7. After selecting a template to use, select the **OK** button. A report will be displayed in the main DataView® window containing the recorded sample data in the format associated with the template.
8. To save the report, go to **File > Save** and save the file in the desired location.

5.9 Downloading Recorded Instrument Data

Recorded measurements stored in the instrument are transferred to a database on the PC using the download command. Assuming a recording session has been started and stopped, the instrument should have at least one recorded measurement inside it.

To Download a Recording:

- Select **Download** from the Simple Logger® II's **Instrument** menu or click the **Download** button on the toolbar. This begins the transfer of recorded data to the computer. A window displaying the transfer progress will be displayed.
- When complete, the **Save As** dialog box will be displayed.
- In the **Save As** dialog box, specify the name of the database to save the recorded data. If a database already exists with the specified name, a dialog box asking if it should be overwritten will appear. Selecting **No** will allow another database name to be assigned. Selecting **Yes** will overwrite the database.
- Once a database file name is specified, the Session Properties dialog box will be displayed. Complete the information in this dialog box, then click **OK**.
- Once the download has completed successfully, you will be asked if you want to open it. Selecting **Yes** will open DataView® (if not already open) and bring it to the foreground. The **Create View from Template** will be displayed with a default template already selected and the downloaded database specified as the database to be opened. You can accept the defaults by selecting **OK** or select a different template.

5.10 Simple Logger® II Templates

Refer to the DataView® Help files for detailed information about using the logger templates.

Trend Summary Report Template

The Trend Summary Report template is for use with the Simple Logger® II and generates a view with four worksheets. The worksheets contained in this report include the following:

- Cover Sheet
- Trend List
- Alarms
- Instrument Configuration

You can move between the worksheets by selecting the desired worksheet from the worksheet tabs at the bottom of the view (just above the status bar).

The first worksheet is the Cover Sheet and provides information about the recording session. The following illustrates the Cover Sheet:

Trend Summary Report

Recording Start Date	6/1/2007 - 9:40:11 AM
Recording Duration	7.17 (ms)
Instrument ID	L102 - 0AADv

Database: C:\Program Files\DataView\DataFiles\Simple Logger II\data.dvb	
---	--

Operator	Test Site
.	.

Comments



Figure 5-16

The Cover Sheet is used as a cover sheet for the report and contains the following frames:

- **Text Box** - containing the text “Trend Summary Report”.
- **Session Summary** - containing the name of the database used to generate the report.
- **Session Summary** - containing operator information.
- **Session Summary** - containing test site information.
- **Session Summary** - containing operator comments.
- **OLE** - containing the AEMC® Instruments logo.

Using the associated properties window customizes each of these frames. The properties window for a frame is displayed by selecting the frame, then selecting the Properties command from the Frame menu.

The second worksheet is used to view the recorded trend channels and contains the following frames:

- Channel Graph
- Session Summary
- Trend Summary List

The following illustrates the Trend List worksheet:

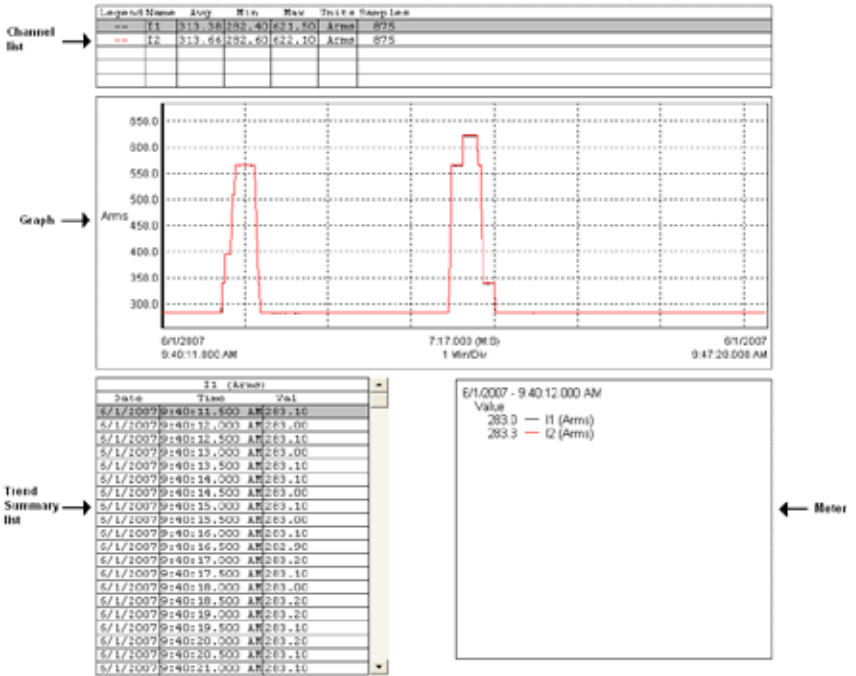

Figure 5-17

The third worksheet is for displaying alarms that were recorded.

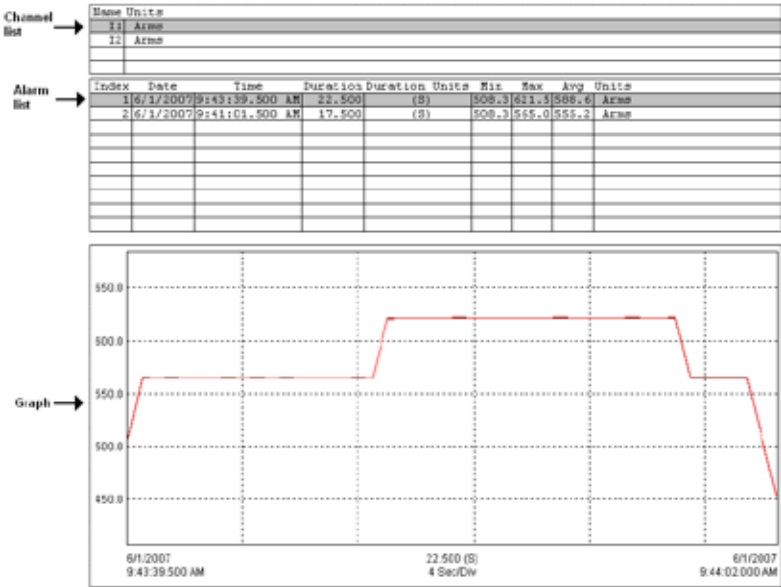

Figure 5-18

The Alarms worksheet (Figure 5-18) allows you to select a channel from the channel list. The Exception List will then be updated to list the exceptions (if any) that occurred on the selected channel. You can then select an exception and the graph time frame will be adjusted to display the trend samples in the associated exception period.

The last work sheet (Figure 5-19) is used to display the configuration of the instrument at the time the session data was recorded. This is the configuration of the instrument while it was recording this data.

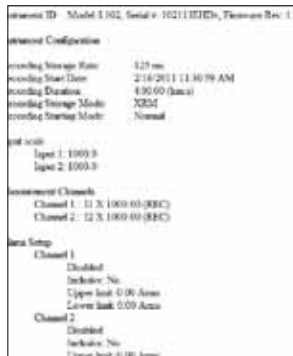

Figure 5-19

Channel Graph Frame

A Channel Graph frame provides a graphical look into the database it is attached to. The database is attached to the Trend Graph frame when it is created. This can be done manually by placing a graph frame or automatically when using a template.

The graph frame provides additional tools for viewing the underlying database. These tools provide zoom and pan operations. In addition, individual traces and waveform snapshots can be selected using the Select Frame tool.

Normally, the Select Frame tool is used to select a frame for modification. In addition to selecting the Graph frame, this tool is used to select individual traces. A trace is selected if any part of it is drawn within a few screen pixels of where the selection tool is when the left mouse button is pressed.

When a trace is selected, handles similar to those of the frame handles are drawn over the trace. If more than one trace is drawn within the proximity of the selection tool, when clicked again, the next trace will be selected. This will continue until all traces within the selection tools proximity have been selected. At which point, clicking the left mouse button again will select the first trace and the process will repeat.

Frames can be linked together so that when you select a trace or line in one frame another frame shows additional information about the selection. For example when selecting a trace in the graph the trend summary list will be updated to list the sample points for the selected trace.



Linking frames can create a complex interaction between frames. For additional information refer to the DataView® users guide accessible from the help menu of the main DataView® application.

This template contains the following linked frame types:

- Session Summary
- Channel List
- Meter
- Trend Summary List

The channels selected for display and the display properties can be changed at any time using the Channel Graph Properties window. The Channel Graph Properties window can be displayed by right-clicking the mouse pointer while positioned over the Graph frame, then selecting Properties from the pop-up menu.

The display extents of the Channel Graph frame can be changed by using zoom and pan operations. By zooming and panning you change the starting and ending times of the displayed data. By changing the starting and ending display times, you can zoom in, zoom out, pan left and right, pan to start and pan to the end of the measurement data.

To change the display extents of a graph frame, select the frame using either the frame selection tool  or Zoom Tool . Next, use a zoom or pan command from the Zoom menu, or from the toolbar. By clicking and dragging the Zoom Tool across the desired area of the graph, you can select an area to zoom in on.

Channel List Frame

The Channel List frame is a frame attached to either a Channel Graph or Micro-Graph frame. In the case of this template, the parent is a Channel Graph frame. The Channel List frame displays a textual list summary of the channels available in the recording. Each summary line contains user-specified parameters of a specific channel recording.

You can specify the displayed parameters and general display options using the **Channel List Properties** dialog box.

You can step between list entries. Selecting **Pan To Start**, displays the first list entry. Selecting **Pan To End**, displays the last list entry. Selecting the **Step Right** or **Step Left**, displays the next or previous list entry. When stepping through the list entries, the selection will move from each entry for the associated channel.

In addition to stepping through the list with the tool bar, you can select a specific entry listed using the mouse pointer. The text for the selected entry will be highlighted, indicating which entry in the list is currently selected.

Session Summary Frame

The Session Summary frame is a frame attached to the Channel Graph frame. This frame displays a textual summary of its parent frame. You can customize the summary text displayed, using the **Session Summary Properties** dialog box. This dialog box is displayed by right-clicking on the frame and selecting **Properties** from the pop-up menu, or by double-clicking on the frame.

The Trend template contains Session Summary frames displaying the following information:

- Start time and duration of the recorded data and the instrument's identification codes. This frame is in the upper right corner of the first worksheet.
- Database containing the file name and location of the recording data
- Operator information
- Test site information
- Operator comments

The text displayed in the session summary frames is static as long as the data within the associated database remains static. Session Summary frames do not provide the interactive operations available in the Channel Graph and Trend Summary List frames.

Meter Frame

The Meter frame is a frame linked to the Channel Graph frame. The Meter frame displays the values of samples at a specific location on the graph. Left-clicking on the graph displays a black vertical bar. The sample values displayed in the meter frame are associated with the time at the location of this vertical bar. Left-clicking at other areas of the graph will move the vertical bar and update the Meter frame accordingly.

Text Box Frame

A Text Box frame displays text at a given location on the page. The text within the frame is static, in that it does not change. It only changes when you change it. This template contains a Text Box located at the top of the worksheet. The text displayed within this frame is the title of this report (Trend Summary Report). The text, font and other frame properties can be changed using the **Text Box Properties** dialog box.



NOTE: For more information on using the Simple Logger® II Control Panel or DataView®, refer to the Help Files within the software.

MAINTENANCE

Use only factory specified replacement parts. AEMC® will not be held responsible for any accident, incident, or malfunction following a repair done other than by its service center or by an approved repair center.

6.1 Replacing the Batteries



CAUTION: Risk of electric shock. Disconnect all input(s) from the unit or remove the clamp from any conductor before opening the rear cover to change the batteries. Turn the unit off before changing the batteries or loss of recorded data may occur.

- Remove the screw from the battery cover.
- Push down and slide off cover to remove.
- Replace the two 1.5V AA (LR6) alkaline batteries (the backup capacitor provides backup power for approximately 10 seconds while the main batteries are being changed).
- Replace the cover and the screw.
- Press the **PRESS** button for 2 seconds to turn the instrument ON.

NOTE: When changing the batteries, always replace both batteries.



If the instrument is stored without the batteries installed, the internal clock will need to be reset using the Simple Logger® II Control Panel software once the batteries are installed. Only store the unit with the batteries installed for short periods of time. For prolonged storage of the unit, it is recommended to remove the batteries.

6.2 Replacing the Fuse (Model L111)



CAUTION: Risk of electric shock. Disconnect all input(s) from the unit or remove the clamp from any conductor before replacing the fuse.

- With a flat-head screwdriver, twist the spring-loaded fuse holder one quarter turn counter-clockwise.
- The fuse holder will automatically eject.
- Replace with a new 2A FA 250V 5x20mm fuse, then replace holder.

6.3 Cleaning



CAUTION: Risk of electric shock. Remove the clamp from any conductor or disconnect all input(s) from the unit.

The body of the logger should be cleaned with a damp and soapy cloth. Do not submerge the logger in water. Do not use solvent.

For the Model CL601, it is important to keep the jaw mating surfaces clean at all times. Gently clean the clamp-on jaw mating surfaces with a soft cloth and lightly oil them to prevent rust. Do not use water, solvents or leave any residue.

TROUBLESHOOTING

Symptom: After being in a damp, cold environment, the logger does not function.

Cause, Correction: Condensation may have formed inside the logger, shorting out the circuitry and discharging the battery. Allow the circuit board to dry thoroughly in a warm location.

Symptom: Simple Logger® II does not start recording.

Cause, Correction: Make sure battery power is present. Make sure the PRESS button is pushed long enough to light the GREEN LED and released before the next LED lights. Make sure the RED LED is not double- blinking. If it is, memory is full and you need to erase the data (see § 4.6). Make sure the Simple Logger® II is properly configured so that you have Storage Rate, Recording Period and at least one Measurement Channel specified.

Symptom: Simple Logger® II does not respond to a button press even with fresh batteries installed.

Cause, Correction: Make sure that the instrument is not OFF. Press the button for a short duration (less than 0.5 second). If all the LEDs do not light, then the instrument is OFF. Turn the instrument ON by pressing the PRESS button for two seconds. The LEDs will light solid once the instrument has turned on and you may release the button at that time.

GLOSSARY

Some general terminology associated with the data collection process is listed here for convenience.

Bps: Bits Per Second, a unit of signal transfer speed equal to the number of elements per second. The Simple Logger® II transfers data at the rate of 115200 bps.

Button: An actual key on the logger or computer keyboard or a soft key in the program on the computer screen.

Data logger: A device used to sample and store electrical signals that may be representative of physical phenomena such as temperature, pressure and flow, for long periods of time in an unattended environment.

Download: The process of transferring data from the logger to the computer.

Hz: Hertz, a unit of measure of frequency equivalent to cycles per second.

I/O: Input/output, a device or port capable of sending or receiving digital information.

Port: A name given to any connector allowing input or output of information.

Processor: A computing device used to calculate and run a set of instructions.

Recording session: A recording session is defined as the time and data contained within the starting and ending of a recording.

Resolution: The last significant digit of the measurement.

Zoom: The ability to select a section of the graph and magnify it for better readability.

USB: Universal Serial Bus, a communications port used to access the Data Logger via a computer program (Dataview®).

Repair and Calibration

To ensure that your instrument meets factory specifications, we recommend that it be sent back to our factory Service Center at one-year intervals for recalibration, or as required by other standards or internal procedures.

For instrument repair and calibration:

You must contact our Service Center for a Customer Service Authorization Number (CSA#). This will ensure that when your instrument arrives, it will be tracked and processed promptly. Please write the CSA# on the outside of the shipping container. If the instrument is returned for calibration, we need to know if you want a standard calibration, or a calibration traceable to N.I.S.T. (Includes calibration certificate plus recorded calibration data).

Ship To: Chauvin Arnoux®, Inc. d.b.a. AEMC® Instruments
15 Faraday Drive
Dover, NH 03820 USA
Phone: (800) 945-2362 (Ext. 360)
(603) 749-6434 (Ext. 360)
Fax: (603) 742-2346 or (603) 749-6309
E-mail: repair@aemc.com

(Or contact your authorized distributor)

Cost for repair, standard calibration, and calibration traceable to N.I.S.T. are available.

NOTE: You must obtain a CSA# before returning any instrument.

Technical and Sales Assistance

If you are experiencing any technical problems, or require any assistance with the proper operation or application of your instrument, please call, mail, fax or e-mail our technical support team:

Chauvin Arnoux®, Inc. d.b.a. AEMC® Instruments
200 Foxborough Boulevard
Foxborough, MA 02035 USA
Phone: (800) 343-1391
(508) 698-2115
Fax: (508) 698-2118
E-mail: techsupport@aemc.com
www.aemc.com

NOTE: Do not ship instruments to our Foxborough, MA address.

Limited Warranty

The Simple Logger® II is warranted to the owner for a period of one year from the date of original purchase against defects in manufacture. This limited warranty is given by AEMC® Instruments, not by the distributor from whom it was purchased. This warranty is void if the unit has been tampered with, abused or if the defect is related to service not performed by AEMC® Instruments.

Full warranty coverage and product registration is available on our website at www.aemc.com/warranty.html.

Please print the online Warranty Coverage Information for your records.

What AEMC® Instruments will do:

If a malfunction occurs within the one-year period, you may return the instrument to us for repair, provided we have your warranty registration information on file or a proof of purchase. AEMC® Instruments will, at its option, repair or replace the faulty material.

**REGISTER ONLINE AT:
www.aemc.com**

Warranty Repairs

What you must do to return an Instrument for Warranty Repair:

First, request a Customer Service Authorization Number (CSA#) by phone or by fax from our Service Department (see address below), then return the instrument along with the signed CSA Form. Please write the CSA# on the outside of the shipping container. Return the instrument, postage or shipment pre-paid to:

Ship To: Chauvin Arnoux®, Inc. d.b.a. AEMC® Instruments
15 Faraday Drive • Dover, NH 03820 USA
Phone: (800) 945-2362 (Ext. 360)
(603) 749-6434 (Ext. 360)
Fax: (603) 742-2346 or (603) 749-6309
E-mail: repair@aemc.com

Caution: To protect yourself against in-transit loss, we recommend you insure your returned material.

NOTE: You must obtain a CSA# before returning any instrument.

Notes:



01/13

99-MAN 100309 v22