

Robertshaw®

9801i2
9825i2

DELUXE
PROGRAMMABLE
THERMOSTATS



110-1175

User's Manual

Menu Driven Display
Humidify / Dehumidify Control
Fully Programmable
Brighter / Adjustable Backlight
Night Light Option
Auto Changeover
Automatic Daylight Saving Time
24 VAC with
Worry-Free Memory Storage
English, Spanish or
French Display Option



Five Year Warranty

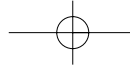
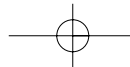
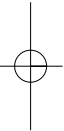
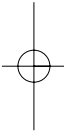
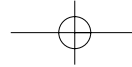

TABLE OF CONTENTS

Important Safety Information	4
Know Your Thermostat's Controls and Displays	
Control Buttons	5
Displays.....	6-7
Choose Heating/Cooling	8
Override Current Settings (Hold)	
Temporary	9
Vacation	9
Auto Changeover	10
Override Fan Operation	11
Programming the Thermostat	
Reset to EnergyStar®	12
Events per Day	12
Program	13
Sensor	13
Set Time and Day	14
Humidify	15
Dehumidify	16
Comfort Settings	
1st Stage Differential	17
2nd Stage Differential	17
2nd Stage Delay	17
Sensor	17
Deadband.....	18
Efficient Recovery	18





Customize the Display

Fahrenheit or Celsius19
Show Set Temperature19
Choose a Language (English, French or Spanish)19
Temperature Offset (Calibrate the Thermostat)19
Resolution (Temperature Display)19
Air Quality Service Reminders (Filter, UV Light, Humidifier Pad).....20
Display Settings – Brightness and Contrast20

System Settings

Equipment Setup.....21
1st/2nd Stage Heating21
Compressor Type21
2nd Stage Fan21
1st/2nd Stage Cooling22
Short Cycle22
Residual Cool.....22
Balance Points22
Set Service Reminders23
Set Temperature Limits23
Auto Changeover24
Contact Information24
Reset to Defaults24
Security On/Off (Controls System Settings only)25

Preventing Thermostat Access

Allow Temperature Adjustment26
Security On/Off (Controls all thermostat functions)26

Tech Support

Frequently Asked Questions

Warranty

28-32

33

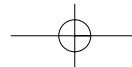
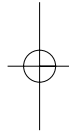

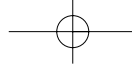

IMPORTANT SAFETY INFORMATION

⚠ WARNING:

- Always turn off power at the main power source by unscrewing fuse or switching circuit breaker to the off position before installing, removing, or cleaning this thermostat.
- Read all of the information in this manual before programming this thermostat.
- This is a 24V AC low-voltage thermostat. Do not install on voltages higher than 30V AC.
- All wiring must conform to local and national building and electrical codes and ordinances.
- Do not short (jumper) across terminals on the gas valve or at the system control to test installation. This will damage the thermostat and void the warranty.
- Do not connect ground to any terminal in this unit.
- This thermostat is equipped with configurable automatic compressor protection to prevent potential damage due to short cycling or extended power outages. The short cycle protection provides up to a 5-minute delay between heating (heat pump only) or cooling cycles to prevent the compressor from being damaged.
- Do not switch system to cool if the temperature is below 50°F (10°C). This can damage the cooling system and may cause personal injury.
- Use this thermostat only as described in this manual.

About this guide: This User's Guide deals with the basic display and programming features of this thermostat. It is not an exhaustive technical guide for every application and combination of heating/cooling equipment and controls that might be connected to the thermostat.

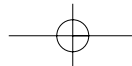

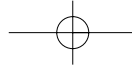

KNOW YOUR THERMOSTAT'S CONTROLS AND DISPLAYS page 1 of 3

NOTE: In many cases the installer made the initial setup of your thermostat. That was based on your preferences and the characteristics of your heating/cooling system. Our User's Guide gives information allowing you to make basic modifications for your home environment at any time.

Become familiar with your thermostat's controls and displays by reviewing the information on the next three pages.

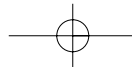
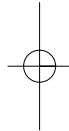
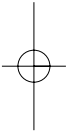
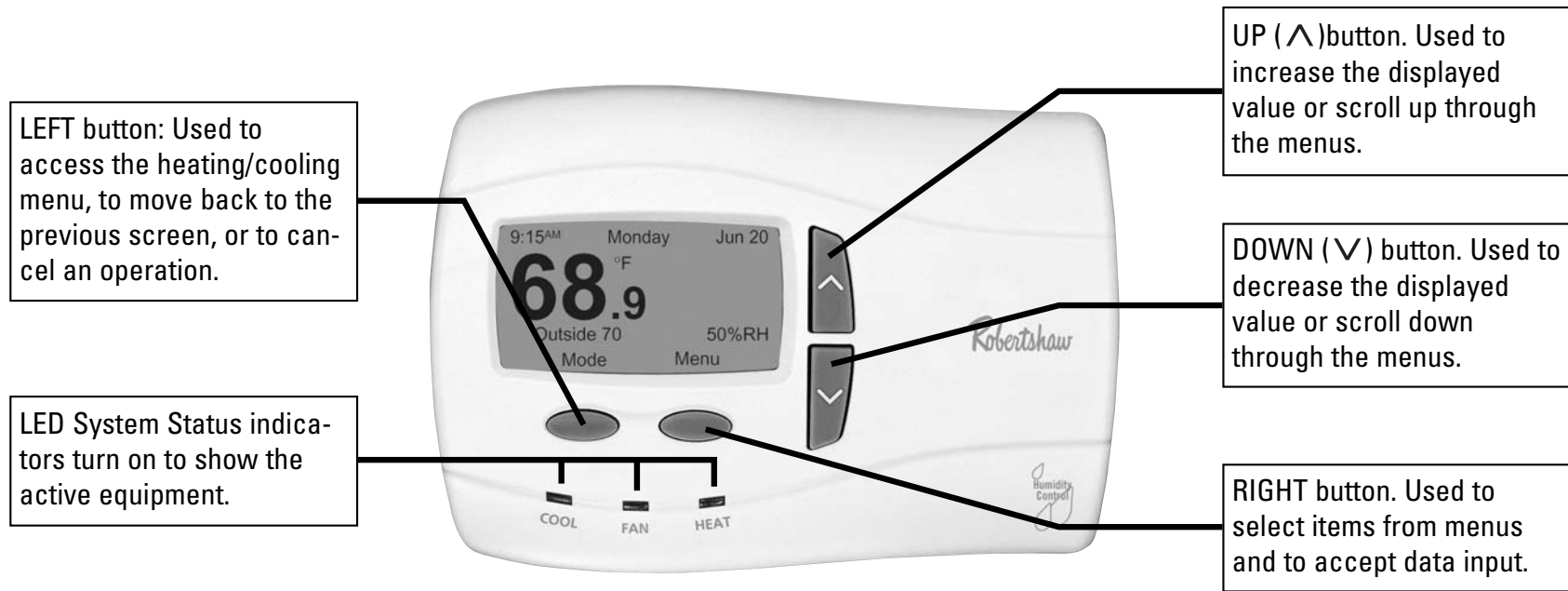

KNOW YOUR THERMOSTAT'S CONTROLS AND DISPLAYS page 2 of 3

3 Typical Main Screen Views

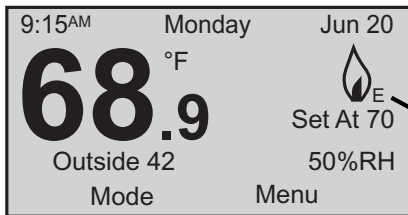
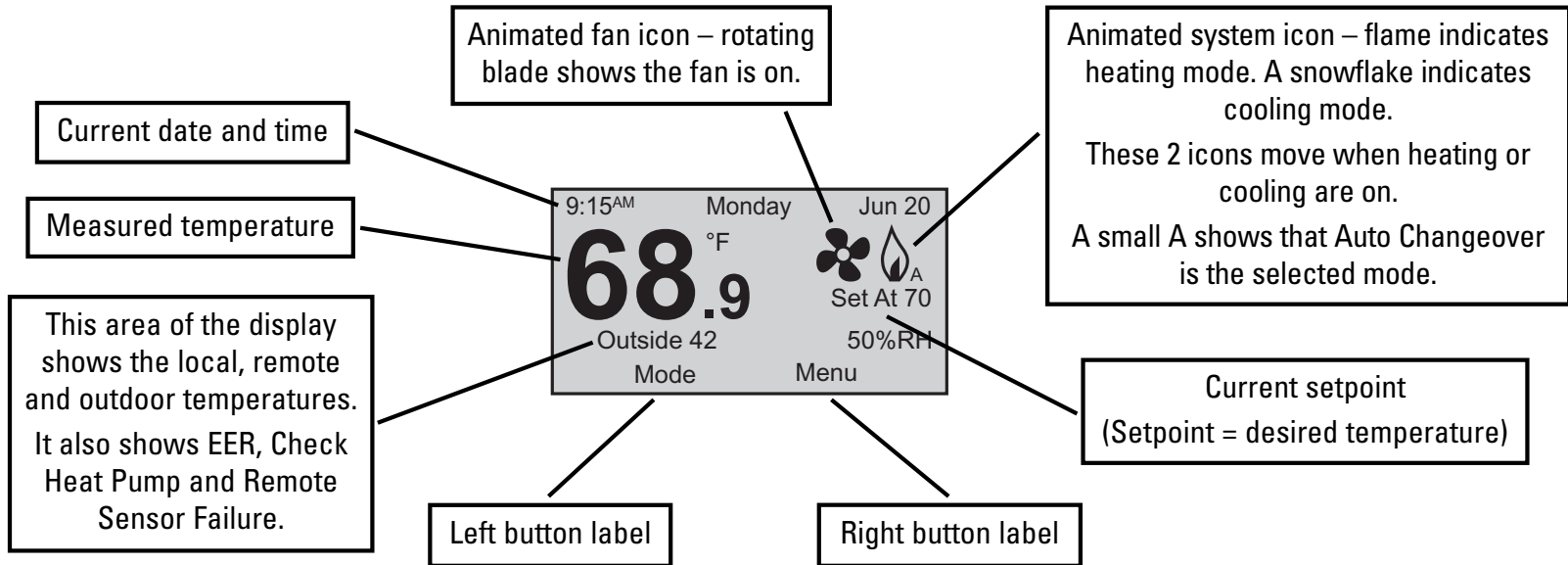

A small E shows that Emergency Heat (heat pump only) is the selected mode.

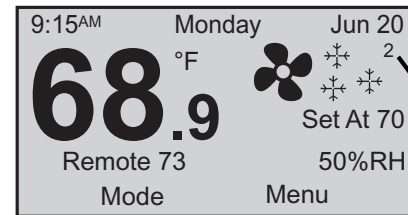

A number 2 shows that the 2nd stage is active.

KNOW YOUR THERMOSTAT'S CONTROLS AND DISPLAYS page 3 of 3

3 Typical Menu Views

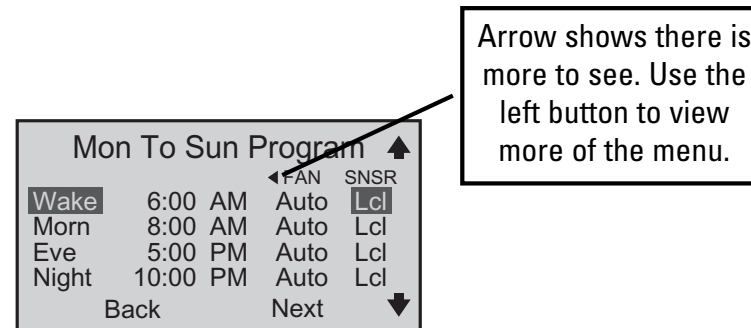
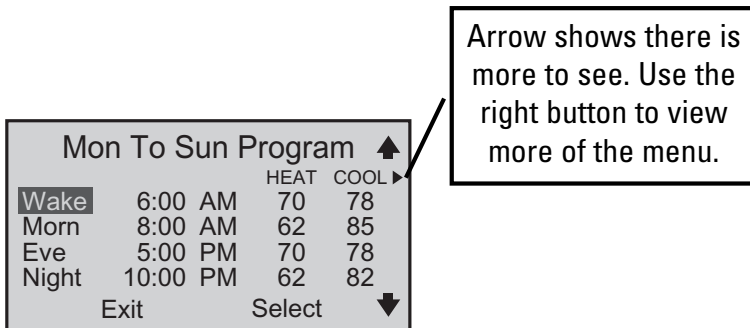
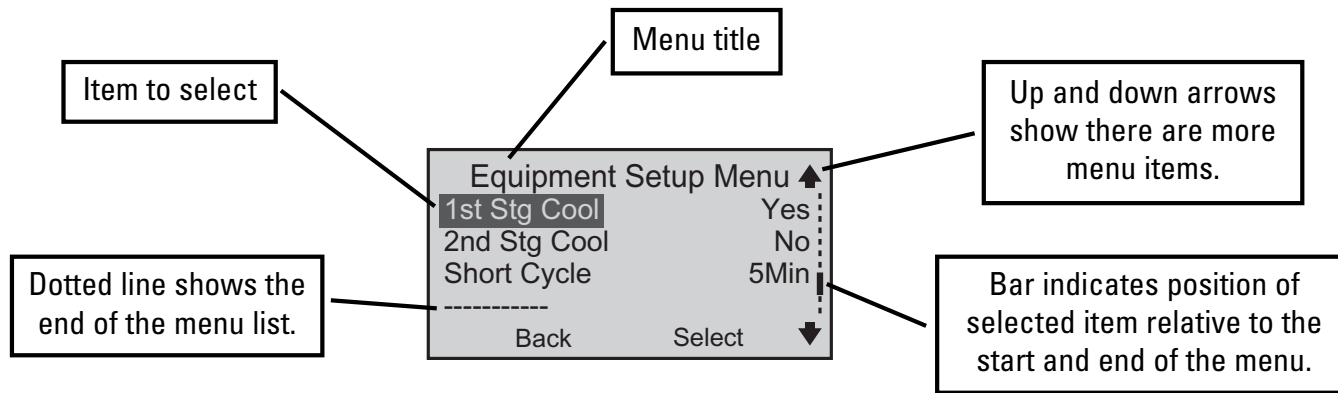

CHOOSE HEATING/COOLING

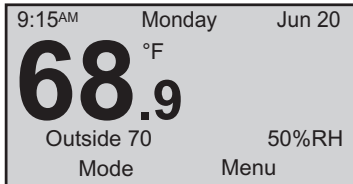

To choose a mode (of operation), select **Mode**.

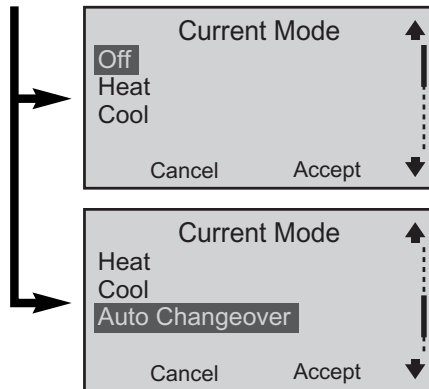

There are five possible operating modes:

Off – The heating/cooling systems are turned off, and will not operate.

Heat – The heating system is activated. The main screen displays the heat icon (♠).

Cool – The cooling system is activated. The main screen displays the cool icon (❄).

Auto Changeover – Either heating or cooling will be activated to maintain the temperature setpoint. The main screen displays the letter A next to the ♠ or ❄.

NOTE: Auto Changeover will be displayed only if activated in **System Settings**.

Emer – Emergency heat is activated. (This choice is available only when 1st stage Heat is set as Heat Pump.)

The main screen displays a small letter E next to the ♠.

Note: Emer will not automatically energize on the 9801i2. You will need to manually select it from the **Current Mode** menu.

Note: Balance points are not an option when an outdoor sensor is installed with the 9801i2.

When should I select Emergency Heat?

If your heat pump is not adequately providing heat, you can bypass it by selecting Emergency (heat) until the heat pump can be serviced. In some installations, your thermostat may indicate a problem with the heat pump by displaying a message (on the main screen) underneath the temperature. You may also want to select Emergency (heat) when the outdoor temperature drops below freezing since the heat pump is very inefficient at low temperatures.

See **Balance Points** (page 22) for other options.

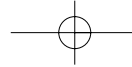

OVERRIDE CURRENT SETTINGS page 1 of 2

NOTES: These directions are for both Heating and Cooling.

Hold does not appear in the **Main Menu** if **Off** is the selected mode.

To access the **Override Settings**, select **Menu** on the main screen.

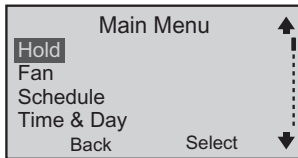

Hold – With this menu item you may override the current temperature setpoint and choose a new setpoint to be held during the override period. This can be a few hours, or it can be a longer period.

To start a Hold: On the **Main Menu**, scroll to **Hold**, and press **Select**. OR. . . While at the main screen, press either the \wedge or \vee button. In either case, the **Hold Temperature** screen appears.

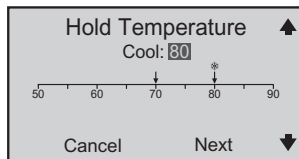

Set the **Hold Temperature** by pressing the \wedge or \vee button until the desired temperature is displayed. Select **Next**. The **Select Override Type** screen appears.

NOTE: The unlabeled arrow is the current room temperature. The arrow with a \diamond or \ast is the programmed setpoint for that mode.

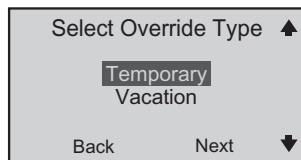

A **Temporary** override lasts up to 24 hours.
A **Vacation** override lasts up to one year.

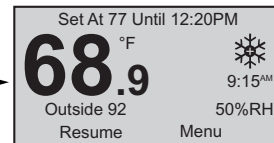
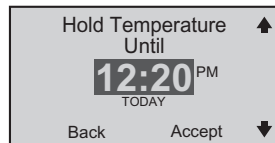

Temporary Hold – Select the time when the hold will end. Select **Accept**. The **Main Menu** will appear. Select **Back**. The main screen will show the hold temperature and time. When the hold expires, normal operation continues.

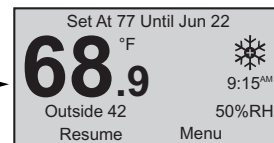
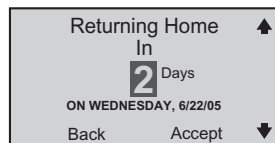

Vacation Hold – Select the number of days for the hold to last. Select **Accept**. The **Main Menu** will appear. Select **Back**. The main screen will show the hold temperature and time. Vacation hold ends at midnight on the last day.

NOTE: To cancel the hold at any time, select **Resume**.

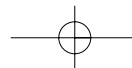

OVERRIDE CURRENT SETTINGS page 2 of 2



Setting a hold when the operating mode is **Auto Changeover**.



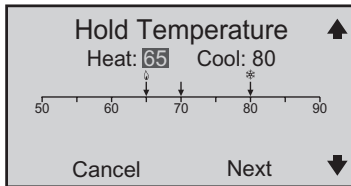

When the selected mode is Auto Changeover, setting a hold means that two setpoints (one for heat and one for cool) have to be chosen. The distance between the heating and cooling setpoints cannot be smaller than the deadband. (For more information about deadband, see **COMFORT SETTINGS** on page 18.)

NOTE: There is a letter **A** next to the  on the main screen. This shows that Auto Changeover is active.

The settings are the same for Auto Changeover as they are for just Heat or Cool (see previous page), except both a heat and cool hold temperature must be selected.



NOTE: The  or  above the arrows are the heat and cool setpoints respectively. The unlabeled arrow is the current room temperature.

Press the  or  button until the desired **Heat** temperature is displayed. Select **Next**. Press the  or  button until the desired **Cool** temperature is displayed. Select **Next**. The **Select Override Type** screen appears. Follow the **Select Override Type** steps from the previous page to complete the hold setting.

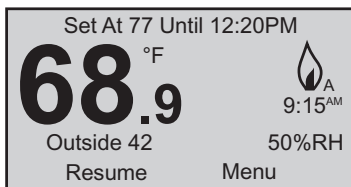

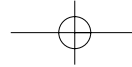

OVERRIDE FAN OPERATION

NOTE: Choosing a fan mode (**On**, **Auto** or **Intermittent**) with the Fan Menu overrides the fan choices made when you use the Main Menu's Schedule option. (See **PROGRAMMING THE THERMOSTAT** on page 12 and 13.)

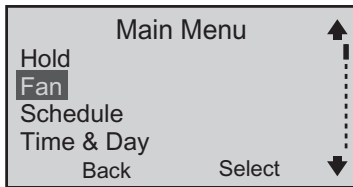

Select **Menu** from the main screen.
Select **Fan** from the **Main Menu**.

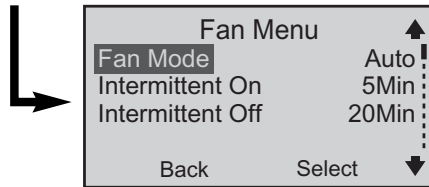

The first item on the **Fan Menu** is **Fan Mode**.

Possible fan modes are:

On – In this mode the fan is constantly on until a different fan mode is chosen.

Auto – The fan operates when either the heating system or cooling system require it.

Intermittent – Use this fan mode to circulate the air in your home between heating or cooling cycles.

The fan operates similarly to Auto mode. When heating or cooling equipment is not active, the fan circulates the air for **Intermittent On** (how long the fan will be on) and **Intermittent Off** (how long the fan will be off) times you set. These times are set from the Fan Menu by selecting the Intermittent On or Intermittent Off option and then using the **^** or **v** button to select the desired amount of time.

Program – In this fan mode, fan operation is determined by the programming done through the **Program Menu**. (For more information, see **PROGRAMMING THE THERMOSTAT** on page 12 and 13.)

Select this mode if the fan operation was overridden and you would like it to resume the settings made in the original program.

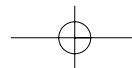
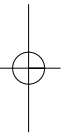
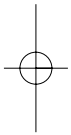

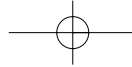

PROGRAMMING THE THERMOSTAT page 1 of 2

About EnergyStar®

Your thermostat has been preprogrammed with a schedule of setpoints recommended by EnergyStar (www.energystar.gov). This schedule is designed to lower your energy costs year-round.

If you changed the schedule and want to return to the EnergyStar schedule, you can do that at any time by selecting **Menu, Schedule, Reset to EnergyStar**.

EnergyStar® Event Setpoints

	Winter (Heating)	Summer (Cooling)
Morning	70°F (21°C)	78°F (25°C)
Day	62°F (17°C)	85°F (29°C)
Evening	70°F (21°C)	78°F (25°C)
Night	62°F (17°C)	82°F (28°C)

From the main screen, select **Menu**.

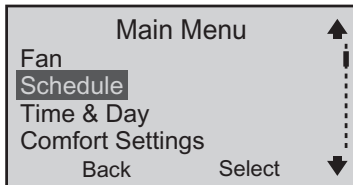

From the **Main Menu**, select **Schedule**.

Your schedule is based on the number of events you want each day. Each event includes a time of day, heating and cooling setpoint, fan setting, and sensor setting. (Sensor setting only appears when a remote sensor is installed.) There can be two, four, or six events per day.

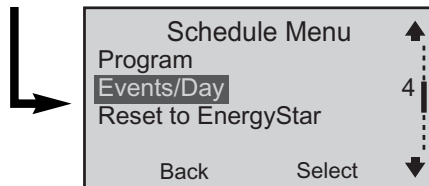

You can change how many events per day by selecting **Events/Day**.

In the following programming example, the **Schedule Menu** shows the default of four events per day.

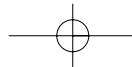

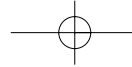

PROGRAMMING THE THERMOSTAT page 2 of 2

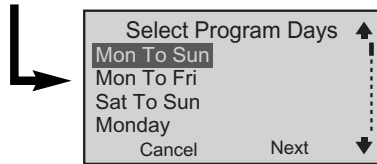

From the main screen, select **Menu**, then **Schedule**, then **Program**. This will take you to the **Select Program Days** menu. The choices are:

Mon to Sun – All days of the week will be set the same.

Mon to Fri – Five weekdays can be set the same.

Sat to Sun – Weekend days can be set differently from the weekdays.

Individual Days (you may select the actual individual days) – Each day can be set separately.

NOTE: If your programming does not cover all the days of the week, the EnergyStar® setpoints are used for the remainder of the days. Even if you select one of the groups of days (e.g., Mon to Sun), you may still select individual days and program those differently.

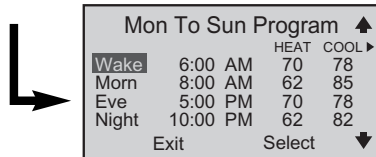

Once you select the day or set of days:

NOTE: In this example there are four events (Wake, Morn, Eve and Night) in a Monday to Sunday program. The previous page explained how to change the number of events.

Selecting Next will change the highlighted selection.

Choose one event (Wake, for instance), and make changes to the four items in that row:

Time – Select a time. The thermostat allows for changes in 10-minute increments.

Heat and Cool – Select temperature. Adjustments are in one-degree increments.

Fan – Choose **On**, **Auto**, or **Int** (Intermittent). (See **OVERRIDE FAN OPERATION** on page 11.)

NOTE: You will see this message: Would You Like To Change Fan Mode To Program? If you select **No**, the setting you chose is shown but not used. The setting in the **Fan Mode Menu** takes priority.

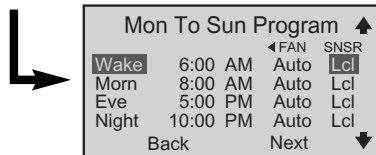

If a remote sensor is installed, **SNSR** will be the fifth item to program.

SNSR – In this column you select the temperature sensor(s) used to control the thermostat.

Lcl selects the local sensor built-in to the thermostat, and is the default setting for this menu item. **Rmt** selects the remote indoor sensor. This choice also disables the local sensor. **Avg**

selects the average temperature of the local and remote sensors.

NOTE: Sensor selection made here overrides the sensor choice made with Comfort Settings. You may see this message: Do You Want Sensor to Change to Program? If you select **Yes**, Sensor will change to **Program** in **Comfort Settings** (see page 17).

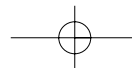

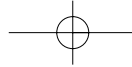

TIME & DAY

NOTE: The main screen time/day/date line flashes until time and date are set.

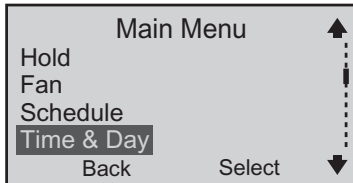

Select **Time & Day** from the **Main Menu**.

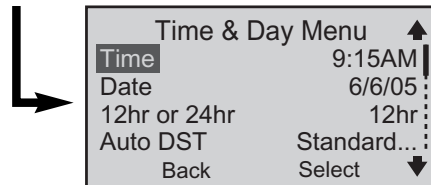

With the **Time & Day Menu** you can make these four settings:

Time – Set the Time by setting the hour and then the minutes.

Date – Set the month, then the day, then the year.

12hr or 24hr – Select a clock type; either a 12-hour or 24-hour format.

Auto DST – Choose whether you want the thermostat's clock to adjust automatically for Daylight Saving Time.

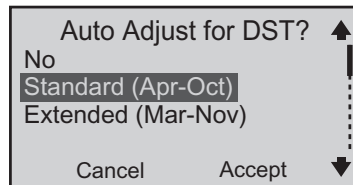

No – Makes the Auto DST feature inactive.

Standard (Apr - Oct) – The clock will be automatically set one hour ahead at 2:00 am on the first Sunday in April, and set one hour back at 2:00 am on the last Sunday in October.

Extended (Mar - Nov) – The clock will be automatically set one hour ahead at 2:00 am on the second Sunday in March, and set one hour back at 2:00 am on the first Sunday in November. (The **Extended** option meets conditions of U.S. Federal Daylight Saving Time legislation that goes into effect in 2007.)

NOTE: When finished with these settings, check the main screen to see that the correct day and time are displayed.

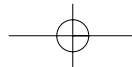

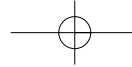

HUMIDIFY

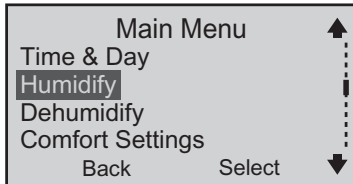

Choose **Humidify** from the **Main Menu**.
The three items available in this menu are explained below.

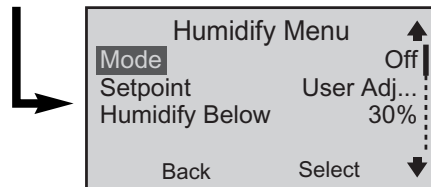

Mode choices are:

Off – Humidity level will not be controlled through the thermostat.

With Heating – Humidification will occur only during a heat cycle and when the indoor humidity level falls 2% below the humidity setpoint.

Independent Of Heating – Humidification will occur when the measured humidity level falls 2% below the humidity setpoint regardless of a call for heat.

NOTE: Setpoint is only an option when an outdoor sensor is installed.

Setpoint choices are:

User Adjust – Humidification will occur based on the user setting.

Automatic – This selection can be made only when an outdoor sensor is connected. Humidity setpoint is based on the outdoor temperature and the dew point adjustment (see below).

Notes: If **Setpoint** is set to **User Adjust**, **Humidify Below** will be the option on the **Humidify Menu**.

If **Setpoint** is set to **Automatic**, **Dew Point Adj** will be the option on the **Humidify Menu**.

Humidify Below – This is where you set your preference of the humidity level. The range is 15% to 45%.

Dew Point Adj – Range -15% to +15%. This feature is typically used to help prevent condensation from forming. In general, the lower the outdoor temperature, the lower the humidity level must be to avoid condensation. Because each house has different tightness characteristics, the **Dew Point Adj** setpoint may need to be adjusted to optimize humidity control.

NOTE: When humidification is active, the main screen will include the icon next to the measured humidity.

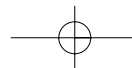
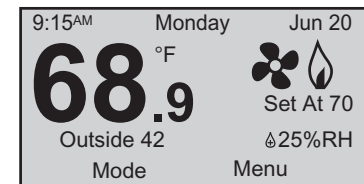
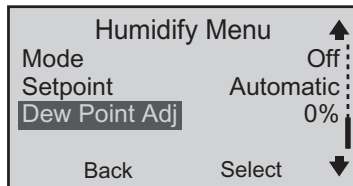
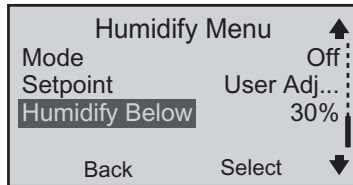

DEHUMIDIFY

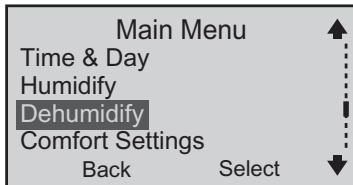

Choose **Dehumidify** from the **Main Menu**.
The three items available in this menu are explained below.

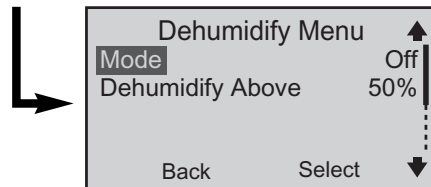

Mode choices are:

Off – Humidity level will not be controlled through the thermostat.

With Cooling – Dehumidification will occur only during a cooling cycle and when the indoor humidity level rises 2% above the humidity setpoint.

Independent Of Cooling – Dehumidification will occur when the measured humidity level rises 2% above the humidity setpoint regardless of a call for cooling.

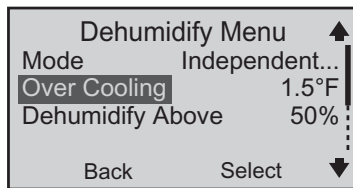

NOTE: If **Mode** is set to **Independent of Cooling**, **Over Cooling** will be an option on the **Dehumidify Menu**.

Over Cooling – To achieve more dehumidification, the thermostat will allow cooling beyond the temperature setpoint by the entered amount. Range 0.5°F to 2.0°F.

Dehumidify Above – This is where you set your preference of the humidity level. The range is 45% to 60%.

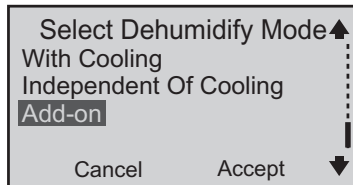

Add-on – Cycles the dehumidifier regardless of a call for cooling. In order to get full use of this mode, it should only be selected when a duct mounted dehumidifier is installed.

NOTE: When dehumidification is active, the main screen will include the  icon next to the measured humidity.

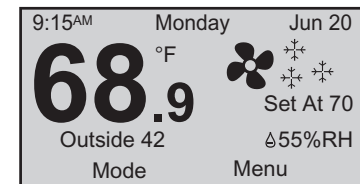

COMFORT SETTINGS page 1 of 2

NOTE: Every person has preferences about personal comfort. The following pages refer to a level of satisfaction with your home environment as it relates to the operation of the heating and cooling system.

Comfort Settings control equipment cycling (on/off periods), staging and sensors that may be connected to your thermostat.

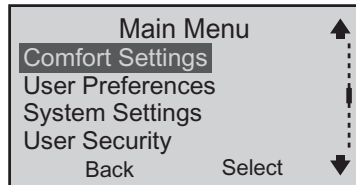

Choose **Comfort Settings**, from the **Main Menu**.

The four items available in this menu are explained below.

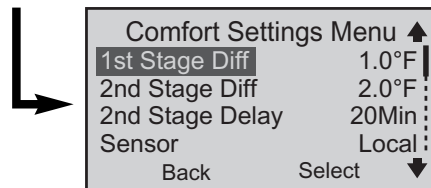

1st Stage Differential is the number of degrees away from the setpoint that the thermostat allows before it calls for the 1st stage equipment to be activated. As this setting is lowered, your system will cycle more frequently.

2nd Stage Differential is the number of degrees away from 1st stage activation that the thermostat allows before 2nd stage equipment is activated. (Temperature demand overrides the 2nd Stage Delay.)

This feature is available only on the 9825i2 models.

2nd Stage Delay is a timed delay between 5 and 40 minutes. It is the maximum time 1st stage equipment tries to satisfy demand before the second stage equipment is activated.

This feature is available only on the 9825i2 models.

Sensor appears only if a remote sensor is connected to the thermostat.

If a remote sensor is connected, you can choose to have the temperature controlled by the thermostat's built-in sensor (Local), by the remote sensor (Remote), or by an average between the two sensors (Average). You also can select **Program**, which means the sensor selection is controlled by the programmed schedule.

See the **SNRS** section in **PROGRAMMING THE THERMOSTAT** on page 13. Also, see **Do I need an accessory sensor?** in **FREQUENTLY ASKED QUESTIONS** for sensor choice and faulty sensor information.

COMFORT SETTINGS page 2 of 2

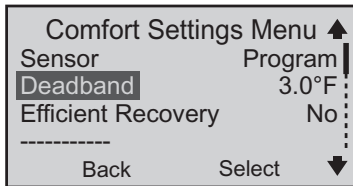

Deadband is used only when the thermostat is set in the **Auto Changeover** mode. The deadband refers to a band or range between the heating and cooling setpoints that controls how often the thermostat switches from heating to cooling and vice versa.

The lower the deadband, the more often the thermostat will switch between heating and cooling, usually in the fall and spring.

(For more information, see **What is deadband?** in **FREQUENTLY ASKED QUESTIONS** on page 29.)

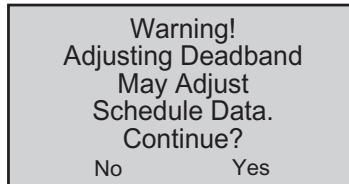

The Warning shown to the left appears alerting you that Deadband adjustments may affect Schedule data.

This means setpoints already entered into the program may be changed when the deadband is put into effect.

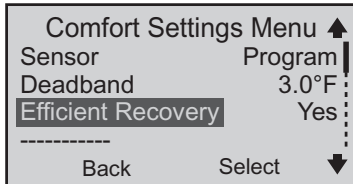

When (Energy) **Efficient Recovery** is turned on (**Yes**), the thermostat attempts to reach the next setpoint at the exact time of the next event. If you have two stages, the thermostat will use only the first stage during this period. This is more efficient than waiting until the next event and then turning on both first and second stages.

(For more information, see **What is Energy Efficient Recovery™ (EER™)?** in **FREQUENTLY ASKED QUESTIONS** on page 29.)

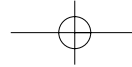

CUSTOMIZE THE DISPLAY page 1 of 2

User Preferences provides you with more ways to customize the displayed information and maintain optimal comfort.

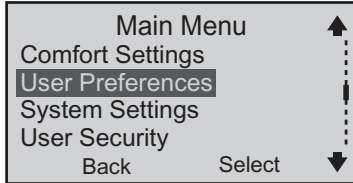

From the **Main Menu**, choose **User Preferences**.

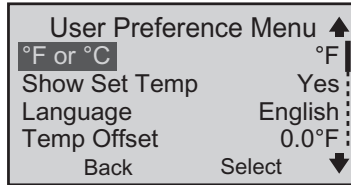

°F or °C – Allows temperature to be displayed in either the Fahrenheit or Celsius scale.

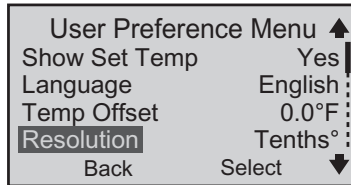

Show Set Temp – Allows for the temperature setpoint to be displayed. (See the example at right.)

Language – You can choose to display thermostat information in English, French or Spanish.

Temp Offset – Allows for offsetting the factory calibration by $\pm 3^{\circ}\text{F}$ or $\pm 1.5^{\circ}\text{C}$.

Resolution – Personalize the way the main temperature is displayed. The main screen temperature display can be in whole degrees, in half degrees, or in tenths of a degree.

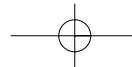
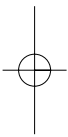
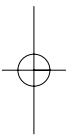
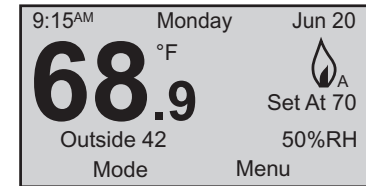

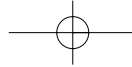

CUSTOMIZE THE DISPLAY page 2 of 2

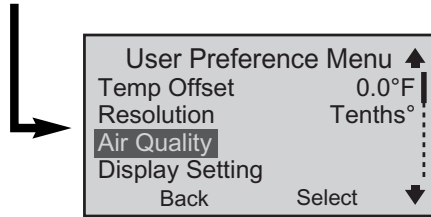

Air Quality – Sets service reminders for parts of the heating/cooling system that need periodic attention.

Based on the intervals you set, these service reminders are displayed on the main screen when a part needs to be serviced:

Replace or Clean Filter

UV Filter: Replace Bulb

Replace or Clean Humidifier Pad

All service intervals can be set to OFF or for a period of 1-12 months.

When the main screen reminder appears, you can select either of these choices:

Delay – This is a 24-hour delay. The reminder appears again in one day.

Reset – This resets the service reminder. It will appear again at the end of the interval that’s been set.

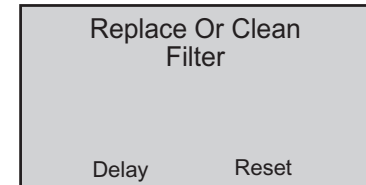

Display Settings – Changes screen brightness and contrast control.

Idle Brightness – Refers to backlight brightness. When turned **ON**, this feature can be used as a night light.

Active Brightness – Refers to backlight brightness when any of the keys are being used.

Contrast – Refers to screen clarity.

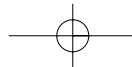
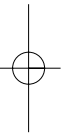

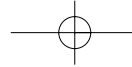

SYSTEM SETTINGS page 1 of 5

NOTE: Only the installing contractor should set System Settings.

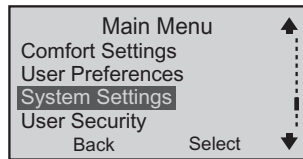

Choose **System Settings** from the **Main Menu**.

The **System Settings Menu** gives nine more ways to get the most from the thermostat.

The information below describes how these features enhance thermostat performance.

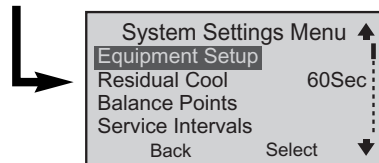

Equipment Setup – Make selections about the types of equipment used in your heating/cooling system.

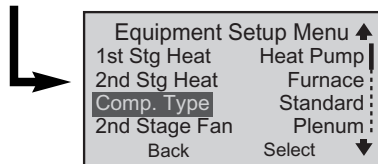

First, choose what type of equipment is used for the 1st Stage Heat.

Choices are: **None**, **Furnace** (e.g., gas forced air furnace), **Strip** (e.g., electric baseboard heating), or **Heat Pump**.

On 9825i2 models, choose 2nd Stage Heat.

Choices are: **None**, **Furnace**, **Strip**, or **Heat Pump**.

If **Heat Pump** is chosen for the **1st Stage Heat** and **Furnace** is chosen for the **2nd Stage Heat**, two new menu items will appear on the **Equipment Setup Menu**; **Comp. Type** and **2nd Stage Fan**.

The **Comp. Type** allows you to determine how 1st and 2nd stage heat work together.

Add-On – 1st stage heating compressor on the heat pump will be turned off when 2nd stage heating is activated.

Standard – 1st stage heating compressor will continue to operate with the 2nd stage furnace for added heating.

The **2nd Stage Fan** determines how the fan will operate.

Plenum – Allows the furnace to control the fan.

ON – Allows the thermostat to control the fan.

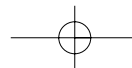
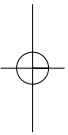
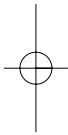

SYSTEM SETTINGS page 2 of 5

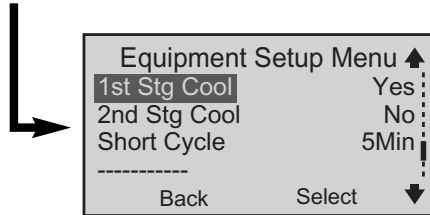

1st Stage Cool equipment – Select **Yes** or **No**.

2nd Stage Cool equipment can be selected for 9825i2 models only – Select **Yes** or **No**.

Short Cycle – The minimum time between heating or cooling cycles intended to protect your equipment. (See the **WARNING** below.) Turn it **Off** or set it from 1 to 5 minutes.

⚠ WARNING: Adjusting the Short Cycle protection may damage the cooling equipment. Check with the equipment manufacturer's recommended settings.

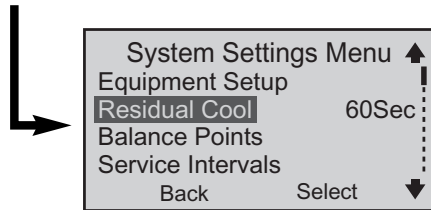

Residual Cool – For cooling system efficiency, this tells the fan to keep running for up to two minutes after the cooling system has shut down.

Balance Points – This choice only appears when the 1st stage is a heat pump. **Low** and **High** balance points are selected. The low balance point prevents the heat pump from being used when it is least efficient. The high balance point prevents the second stage heat (furnace or strip) from activating when the heat pump is most efficient.

Outdoor setpoint temperature ranges are:

Low Setpoint : -20°F to 75°F (-29°C to 24°C)

High Setpoint : 0°F to 75°F (-18°C to 24°C)

(For more information, see **What are balance points?** in **FREQUENTLY ASKED QUESTIONS** on page 28.)

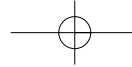

SYSTEM SETTINGS page 3 of 5

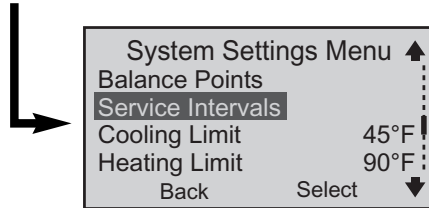

Select **Service Intervals** to set service reminders for primary system components of the heating/cooling system that need periodic attention.

Based on the intervals you set, these reminders are displayed on the main screen when a part needs to be serviced:

Heating System Checkup Recommended
Cooling System Checkup Recommended
Heat Pump System Checkup Recommended

All service intervals can be set to **OFF** or for a period of 1-12 months.

When the main screen reminder appears, you can select either of these choices:

Delay – This is a 24-hour delay. The reminder appears again in one day.

Reset – This resets the service reminder. It will appear again at the end of the interval that's been set.

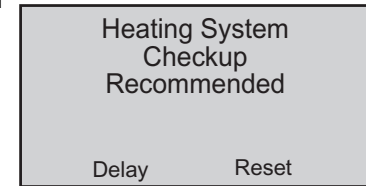

Cooling Limit and Heating Limit.

To prevent extremes in thermostat settings, use this menu item to limit maximum cooling and heating mode temperatures.

Choose either (or both) a cooling or a heating limit to set.

Set a temperature from 45°F to 90°F (7°C to 32°C).

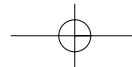
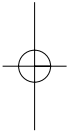
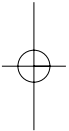

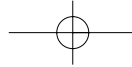

SYSTEM SETTINGS page 4 of 5

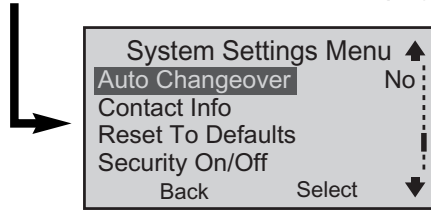

Auto Changeover – When this feature is selected, it allows the thermostat to switch automatically between heating and cooling to maintain the optimal temperature.

A warning appears with an alert that Schedule Data (your programmed settings for the week) may change if Auto Changeover is turned on.

(For more information, see **Deadband** in **COMFORT SETTINGS** on page 18.)

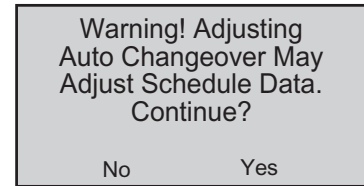

Contact Info – This is a place to store the installing dealer’s contact information.

It provides a two-line display where typically, a name is on line one, and a phone number on line two.

Reset to Defaults – A warning appears. ALL settings (time, date, System Settings, etc.) will be erased and original factory default settings will replace them.

Use this feature when the heating/cooling equipment changes, or when the way the equipment is used changes.

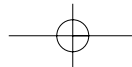
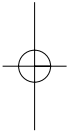
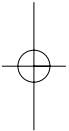
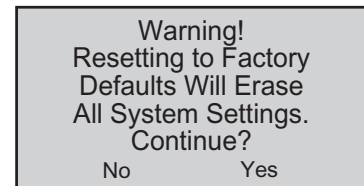

SYSTEM SETTINGS page 5 of 5

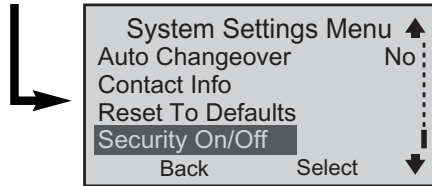

Security On/Off – This item provides security for the **System Settings Menu** only.



To enable Security:

Enter a four-digit PIN. When this number is accepted, a closed lock icon (🔒) appears next to **System Settings** on the **Main Menu**.

With **System Settings** enabled, you need to enter the PIN to review or change the system settings. After the PIN is entered, an open lock icon (🔓) appears.

NOTE: When **System Settings** is unlocked, it will be relocked after 5 minutes of inactivity (i.e., no buttons being pressed).

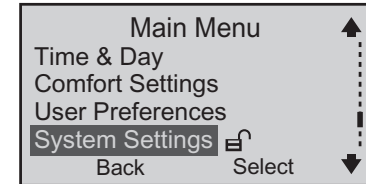
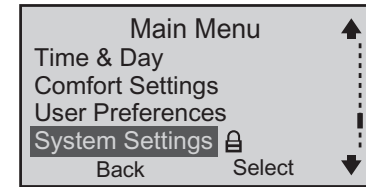

To disable Security:

With Security unlocked, select **System Settings**, then **Security On/Off**. The **Enter PIN to Disable Security** screen appears. Enter the PIN again. Security is disabled. (The lock icon does not appear in the **Main Menu**.)

NOTE: To provide a greater level of security, see **PREVENT THERMOSTAT ACCESS** on the next page.

PREVENT THERMOSTAT ACCESS

Choose **User Security** from the from the **Main Menu** when you want to prevent others from modifying thermostat operation. In effect, you can make the thermostat tamperproof.

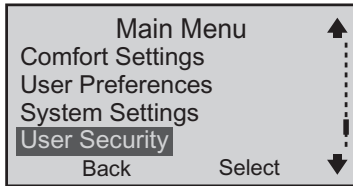

Select **User Security** from the **Main Menu**.

Two choices are available:

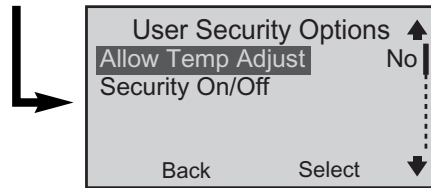

Allow Temp Adjust – Do you want to allow a user to modify the Hold settings while locking out all other use of the thermostat? Choose **Yes** or **No**.

If **Yes** is chosen, use the \wedge and \vee buttons to modify Hold settings (see **OVERRIDE CURRENT SETTINGS** [Hold]).

Security On/Off – Enable Security by entering a four-digit PIN. With Security enabled, ANY use of the thermostat (except for Hold modifications if **Yes** was chosen for **Allow Temp Adjust**) is prevented. The  will be displayed on the main screen when Security is on.

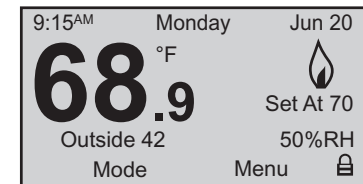

To modify any settings, touch any of the buttons and the **Enter Pin to Unlock Security** screen will appear. Enter the four-digit PIN to proceed.

NOTE: When **User Security** is unlocked, it will be relocked after 5 minutes of inactivity (i.e. no buttons being pressed).

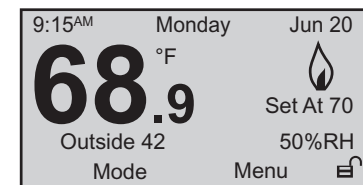

To disable Security:

After Security is unlocked, select **User Security**, then **Security On/Off**, enter the PIN. Security is now disabled. (The lock icon no longer appears on the main screen.)

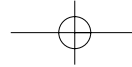

TECHNICAL SUPPORT

Do you have a question about your thermostat?

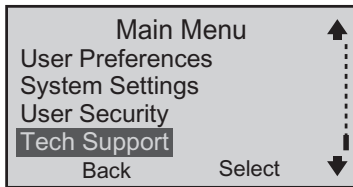

Select **Tech Support** from the **Main Menu** to find technical support contact information.

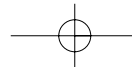
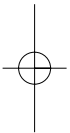
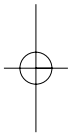
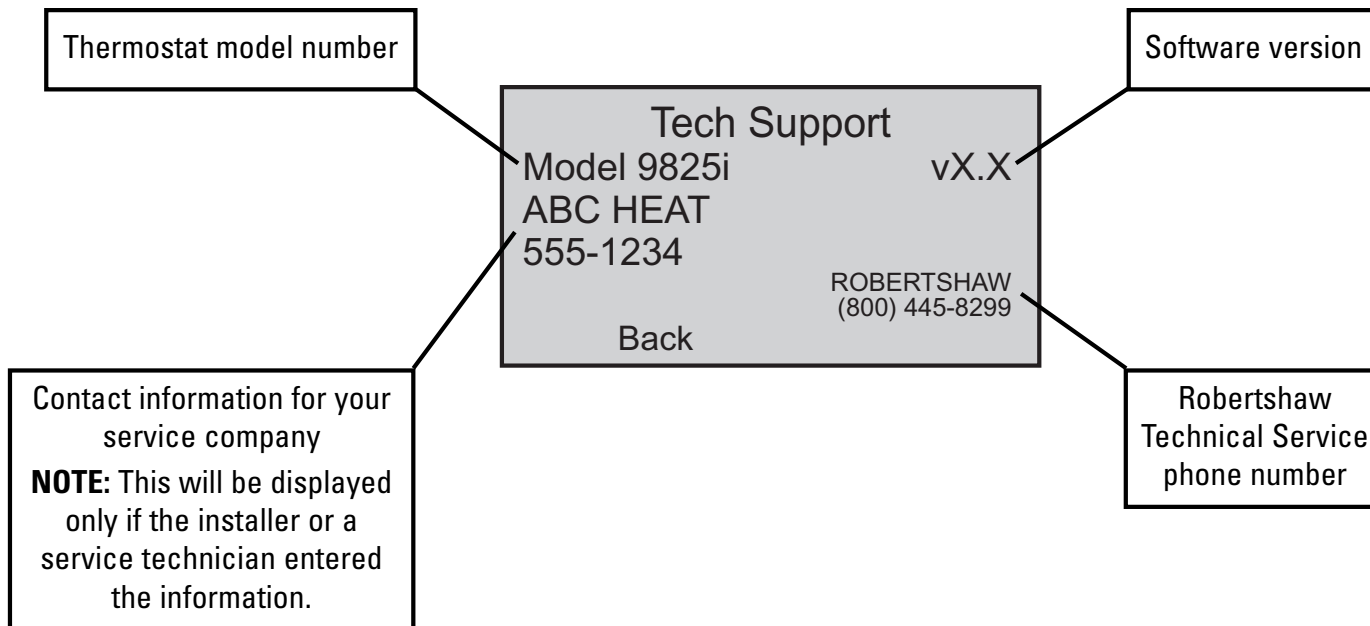

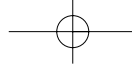

FREQUENTLY ASKED QUESTIONS page 1 of 5

Who should I call for help?

Visit our web site at www.about-i-series.com.

To talk with a Tech Support representative, give us a call at 800-445-8299.

What if I forget my PIN?

Talk with a Tech Support representative at 800-445-8299 to get a temporary PIN.

What should I do if my power goes out?

Make sure your family is safe and don't worry about the thermostat. Your thermostat automatically retains the time of day for approximately two hours in the event of a power outage. All other programmed parameters are stored permanently in memory. If your power is out for more than two hours, simply reset the clock when power returns.

What are balance points?

For a heating/cooling system where the 1st stage heating is a heat pump, balance points prevent the heat pump from operating when the outside temperature is too cold. As the outside temperature drops, heat pump output increases along with the increasing heat requirement for the home. The balance point temperature is reached when heat pump output and the home heating requirement match. Supplemental heating is needed below the balance point temperature. Balance points differ according to climate, however they typically range from 27°F to 35°F.

Why is the time/temperature/backlight flashing?

The time and date need to be set. From the **Main Menu**, go to **Time & Day** and enter the settings.

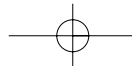

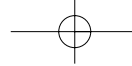

FREQUENTLY ASKED QUESTIONS page 2 of 5

What is deadband?

The deadband refers to a range between the heating and cooling setpoints that controls how often the thermostat switches from heating to cooling and vice versa. The smaller the deadband, the more often the thermostat will switch between heating and cooling, which typically happens in the fall and spring of the year.

As an example, let's say the deadband is set to 3°F and your heating setpoint for a particular event is 68°F. The cooling setpoint for that event can't be lower than 72°F. This prevents your thermostat from constantly cycling between heating and cooling.

What is Energy Efficient Recovery™ (EER™)?

Energy Efficient Recovery™ is an energy saving feature. During a set back period (or set up in cooling), it allows the thermostat to look ahead two hours to determine when to turn on the heating (or cooling) system. During this period, the second stage is locked out to allow the first (and most efficient stage) to bring your home to the desired temperature.

Should I change installer settings?

Don't change the settings made by your installer.

The installer determines these settings based on the type of equipment you have in your home. Only a certified HVAC technician should enter these settings. Changing them could result in higher energy costs and may even damage your equipment. Please use the security lock for **System Settings** to prevent tampering.

What is an event?

An event is a programming period. This could be the period in the morning when you are preparing for work or school. It could be the period when no one is at home. It could be the period when the household is asleep at night.

The time for an event is selected based on when you want the event to occur. For example, if you wake up at 6:30 AM, set the first event for 6:30 AM. With EER™ activated, the thermostat will automatically make sure your home is at the desired temperature selected for that event by the time you wake. If EER™ is not activated, you should set the event times 1/2 hour earlier than the actual time you want your home to be at the desired temperature.

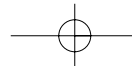

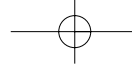

FREQUENTLY ASKED QUESTIONS page 3 of 5

How many events can be programmed?

This thermostat can be set for two, four, or six events per day.

Select two events if someone is home all day. Typically, this requires a constant temperature during the day and a different temperature at night.

Four events are common for working households. Event 1 (WAKE) is the morning period. Event 2 (DAY) is when everybody has left for school or work. Event 3 (EVE) is the return period, coming home from school or work. Event 4 (NIGHT) is when everybody is asleep.

Six events can be used especially when there is activity during the day. Event 1 (WAKE) is the morning period. Event 2 (MORN) is when everybody has left for school or work. Event 3 (NOON) is the lunch period, when the kids may be home for a break. Event 4 (DAY) is the afternoon period when the house is empty. Event 5 (EVE) is the return period, coming home from school or work. Event 6 (NIGHT) is when everybody is asleep.

What program is right for me?

The thermostat is factory set with the US EPA EnergyStar® recommended times and temperatures for optimal energy savings. You can change those settings to suit your lifestyle. Examine your schedule, and set the times and temperatures that fit best. This thermostat is extremely versatile and helps you make changes with ease.

Do I need an accessory sensor?

Remote indoor sensor

The remote indoor sensor (Part No. 9020i) can be used to improve the comfort of your home. When used in conjunction with the local sensor on the thermostat, the two sensors average the sensed temperature and control to that average temperature. You also can use the remote sensor in a stand-alone situation when you want to control the temperature in a remote room but have the thermostat in a secure location.

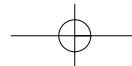

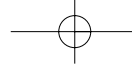

FREQUENTLY ASKED QUESTIONS page 4 of 5

Remote outdoor sensor

The remote outdoor sensor (Part No. 9025i) can be used to aid in the comfort of your home or simply as a sensing device to inquire about outdoor temperature.

With your heat pump system, the remote outdoor sensor helps determine when to turn on the second stage heating for optimal comfort.

Installing a remote outdoor sensor

The remote outdoor sensor should be installed on the northern wall of your home, away from direct sunlight or other heat sources that may affect its sensitivity.

Time of Day Zoning

You may want your thermostat to use the temperature in your living room during the day and the temperature in your bedroom at night. Assuming the thermostat is installed in your living room, you would install the remote sensor in your bedroom. You would then use the **Schedule Menu** to establish a two-event day (Wake and Night). Then make a setpoint of 70° for your living room from 6am to 10pm. Another setpoint of 65° could be made for your bedroom during the hours of 10pm to 6am.

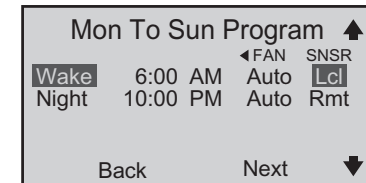

Faulty Sensor

If a remote sensor fails or is disconnected, the thermostat defaults to the built-in local sensor (when you have selected Remote as the sensor choice).

NOTE: Remote Failed also appears on the main screen to indicate a remote sensor failure.

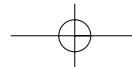

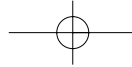

FREQUENTLY ASKED QUESTIONS page 5 of 5

How do I reset the thermostat?

To reset the thermostat, press the \wedge button and the LEFT button at the same time. Hold for five seconds. The information screen, including version, is displayed indicating a reset has occurred.

NOTE: This will NOT reset any of the programmed settings, and it will not disable any of the security provisions.

How do I know if the heating or cooling is on?

The thermostat display will indicate the operating mode, HEAT – with a flame icon, or COOL – with a snowflake icon. When the temperature in your home decreases or increases, the HEATING or COOLING cycle will come on and the thermostat will display the appropriate icon for that mode. When the HVAC system is ON, the LED's along the bottom of the thermostat will turn on, and the main screen icons become animated.

What can I do about high energy bills?

While we can't do anything about the high cost of energy, we can try to use less energy and thereby lower our heating and cooling costs. Generally, the best way to do this is to use the EPA EnergyStar® recommended setpoints for heating and cooling. (See page 12 for the preset EnergyStar setpoints.)

Another way to contain costs is to cycle the heat pump or air conditioner with moderation. The thermostat controls the cycle rate based on temperature differentials. By maintaining a reasonable differential setpoint, 1°F for 1st stage and 2°F for 2nd stage, your equipment will cycle with moderation.

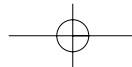

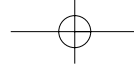

FIVE YEAR LIMITED WARRANTY

The manufacturer warrants to the original contractor installer or to the original consumer user, each new Robertshaw thermostat to be free from defects in materials and workmanship under normal use and service for a period of five (5) years from the date of purchase.

This warranty does not cover batteries (if so equipped), damage caused by batteries, damage resulting from improper installation, alteration, misuse or abuse of the thermostat occurring after the date of purchase.

The manufacturer agrees to repair or replace at its option any thermostat under warranty provided it is returned within the warranty period, postage prepaid, with proof of the date of purchase. Cost of thermostat removal or reinstallation is not the responsibility of the manufacturer.

Repair or replacement as provided under this warranty is the exclusive remedy of the consumer. This warranty and our liability does not apply to merchandise that has been damaged caused by misuse, neglect, mishandling, alterations, improper installation, or use in a way other than in accordance with the recommendations and instructions of the manufacturer. Except to the extent prohibited by applicable law, any implied warranty of merchantability or fitness for a particular purpose on this product is limited to the duration of this warranty.

Some states do not allow the exclusion or limitation of incidental or consequential damages, or allow limitations on how long an implied warranty lasts, so the above limitations or exclusions may not apply to you. This warranty gives you specific legal rights, and you may also have other rights which vary from state to state.

Instructions for return:

Pack the thermostat carefully in a well-padded carton. Be sure to include a note describing, in detail, what is wrong with the product. Return, postage prepaid, to:

In the U.S.:

Invensys Controls Americas
515 South Promenade Avenue
Corona, CA 92879-1736
Attn: Warranty Department

In Canada:

Invensys Controls Americas
3505 Laird Road Unit #14
Mississauga, Ontario L5L 5Y7 Canada
Attn: Warranty Department

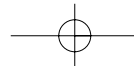

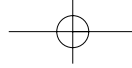

NOTES

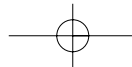
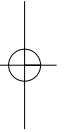
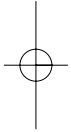

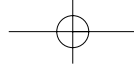

NOTES

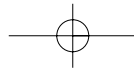
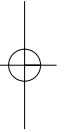

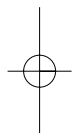
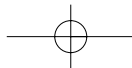

Invensys[®]

Controls Americas

515 South Promenade Avenue

Corona, CA 92879-1736

United States of America

Made in U.S.A.

Patents Pending

www.about-i-series.com

110-1175

