

# Hisense

# USER MANUAL

Before using the TV, please read this manual thoroughly and retain it for future reference.

ES-G131541

条形码定位框 35x10.5mm  
物料号:

**English**

# CHILD SAFETY:

It Makes A Difference How and Where  
You Use Your Flat Panel Display

Congratulations on your purchase! As you enjoy your new product, please keep these safety tips in mind:



## THE ISSUE

- The home theater entertainment experience is a growing trend and larger flat panel displays are popular purchases. However, flat panel displays are not always supported on the proper stands or installed according to the manufacturer's recommendations.
- Flat panel displays that are inappropriately situated on dressers, bookcases, shelves, desks, speakers, chests or carts may fall over and cause injury.

## THIS MANUFACTURER CARES!

- The consumer electronics industry is committed to making home entertainment enjoyable and safe.

## TUNE INTO SAFETY

- One size does NOT fit all. Follow the manufacturer's recommendations for the safe installation and use of your flat panel display.
- Carefully read and understand all enclosed instructions for proper use of this product.
- Don't allow children to climb on or play with furniture and television sets.
- Don't place flat panel displays on furniture that can easily be used as steps, such as a chest of drawers.
- Remember that children can become excited while watching a program, especially on a "larger than life" flat panel display. Care should be taken to place or install the display where it cannot be pushed, pulled over, or knocked down.
- Care should be taken to route all cords and cables connected to the flat panel display so that they cannot be pulled or grabbed by curious children.



## WALL MOUNTING: IF YOU DECIDE TO WALL MOUNT YOUR FLAT PANEL DISPLAY, ALWAYS:

- Use a mount that has been recommended by the display manufacturer and/or listed by an independent laboratory (such as UL, CSA, ETL).
- Follow all instructions supplied by the display and wall mount manufacturers.
- If you have any doubts about your ability to safely install your flat panel display, contact your retailer about professional installation.
- Make sure that the wall where you are mounting the display is appropriate. Some wall mounts are not designed to be mounted to walls with steel studs or old cinder block construction. If you are unsure, contact a professional installer.
- A minimum of two people are required for installation. Flat panel displays can be heavy.

 **CEA**  
Consumer Electronics Association  
[www.CE.org/safety](http://www.CE.org/safety)

# Important Safety Instructions

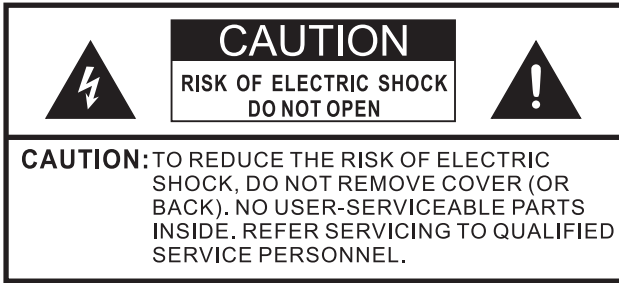

The lightning flash with arrowhead symbol, within an equilateral triangle is intended to alert the user to the presence of uninsulated dangerous voltage within the product's enclosure that may be of sufficient magnitude to constitute a risk of electric shock.



The exclamation point within an equilateral triangle is intended to alert the user to the presence of important operating and maintenance (servicing) instructions in the literature accompanying the appliance.

1. Read these instructions.
2. Keep these instructions.
3. Heed all warnings.
4. Follow all instructions.
5. Do not use this apparatus near water.
6. Clean only with dry cloth.
7. Do not block any ventilation openings. Install in accordance with the manufacturer's instructions.
8. Do not install near any heat sources such as radiators, heat registers, stoves, or other apparatus (including amplifiers) that produce heat.
9. Do not defeat the safety purpose of the polarized or grounding-type plug. A polarized plug has two blades with one wider than the other. A grounding type plug has two blades and a third grounding prong. The wide blade or the third prong are provided for your safety. If the provided plug does not fit into your outlet, consult an electrician for replacement of the obsolete outlet.

10. Protect the power cord from being walked on or pinched particularly at plugs, convenience receptacles, and the point where they exit from the apparatus.
11. Only use attachments/accessories specified by the manufacturer.

12. Use only with cart, stand, tripod, bracket, or table specified by the manufacturer, or sold with the apparatus. When a cart is used, use caution when moving the cart/apparatus combination to avoid injury from tip-over.



S3125A

13. Unplug this apparatus during lightning storms or when unused for long periods of time.
14. Refer all servicing to qualified service personnel. Servicing is required when the apparatus has been damaged in any way, such as power-supply cord or plug is damaged, liquid has been spilled or objects have fallen into the apparatus, the apparatus has been exposed to rain or moisture, does not operate normally, or has been dropped.
15. Apparatus should not be exposed to dripping or splashing, and objects filled with liquids, such as vases, should not be placed on the apparatus.

16. An outside antenna system should not be located in the vicinity of overhead power lines or other electric light or power circuits, or where it can fall into such power lines or circuits. When installing an outside antenna system, extreme care should be taken to keep from touching such power lines or circuits, as contact with them might be fatal.
17. Do not overload wall outlets and extension cords, as this can result in a risk of fire or electric shock.
18. Do not push objects through any openings in this unit, as they may touch dangerous voltage points or short out parts that could result in fire or electric shock. Never spill

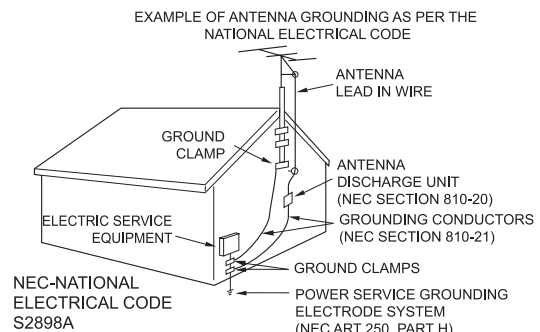

- or spray any type of liquid into the unit.
19. If an outside antenna or cable system is connected to the unit, be sure the antenna or cable system is grounded to provide some protection against voltage surges and built-up static charges, Section 810 of the National Electrical Code, ANSI/NFPA 70, provides information with respect to proper grounding of the mast and supporting structure, grounding of the lead-in wire to an antenna discharge unit, size of grounding conductors, location of antenna discharge unit, connection to grounding electrodes, and requirements for the grounding electrode.
20. When replacement parts are required, be sure the service technician uses replacement parts specified by the manufacturer or those that have the same characteristics as the original part. Unauthorized substitutions may result in fire, electric shock or other hazards.
21. Upon completion of any service or repairs to this unit, ask the service technician to perform safety checks to determine that the unit is in proper operating condition.

# Important Safety Instructions

22. When you connect the product to other equipment, turn off the power and unplug all of the equipment from the wall outlet. Failure to do so may cause an electric shock and serious personal injury. Read the owner's manual of the other equipment carefully and follow the instructions when making any connections.
23. Sudden high volume sound may cause hearing or speaker damage. When you use headphones, (if the unit is equipped with a headphone jack) keep the volume at a moderate level. If you use headphones continuously with high volume sound, it may cause hearing damage.

## CONDENSATION:

Moisture will form in the operating section of the unit if the unit is brought from cool surroundings into a warm room or if the temperature of the room rises suddenly. When this happens, unit's performance will be impaired. To prevent this, let the unit stand in its new surroundings for about an hour before switching it on, or make sure that the room temperature rises gradually.

Condensation may also form during the summer if the unit is exposed to the breeze from an air conditioner. In such cases, change the location of the unit.

## HOW TO HANDLE THE LCD PANEL:

- Do not press hard or jolt the LCD panel. It may cause the LCD panel glass to break and injury may occur.
- If the LCD panel is broken, make absolutely sure that you do not touch the liquid in the panel. This may cause skin inflammation.  
If the liquid gets in your mouth, immediately gargle and consult with your doctor. Also, if the liquid gets in your eyes or touches your skin, consult with your doctor after rinsing for at least 15 minutes or longer in clean water.

## Possible Adverse Effects on LCD Panel:

If a fixed (non-moving) pattern remains on the LCD Panel for long periods of time, the image can become permanently engrained in the LCD Panel and cause subtle but permanent ghost images. This type of damage is NOT COVERED BY YOUR WARRANTY. Never leave your LCD Panel on for long periods of time while it is displaying the following formats or images:

- Fixed Images, such as stock tickers, video game patterns, TV station logos, and websites.
- Special Formats that do not use the entire screen. For example, viewing letterbox style (16:9) media on a normal (4:3) display (black bars at top and bottom of screen); or viewing normal style (4:3) media on a widescreen (16:9) display (black bars on left and right sides of screen).

**The following symptoms are not signs of malfunction but technical limitation. Therefore we disclaim any responsibility for these symptoms.**

- LCD Panels are manufactured using an extremely high level of precision technology, however sometimes parts of the screen may be missing picture elements or have luminous spots.  
This is not a sign of a malfunction.
- Do not install the LCD Panel near electronic equipment that produces electromagnetic waves. Some equipment placed too near this unit may cause interference.
- Effect on infrared devices - There may be interference while using infrared devices such as infrared cordless headphones.

## Declaration of Conformity

This device complies with part 15 of the FCC Rules. Operation is subject to the following two conditions:

- (1) This device may not cause harmful interference and
- (2) This device must accept any interference received, including interference that may cause undesired operation.

## End of life directives

Your TV also contains material that can be recycled and reused. For disposal or recycling information, contact your local authorities or the Electronic Industries Alliance at [www.eia.org](http://www.eia.org) to find a recycler in your area.

## Non-active pixels

The LCD panel contains almost 3 million thin film transistors, which provide exceptionally sharp video quality. Occasionally, a few non-active pixels may appear on the screen as a fixed black (in the case of a dead pixel), blue, green, or red point. These non-active pixels do not adversely affect the performance of your TV, and are not considered defects.

## Power source

### TO USE AC POWER

1. The power cord is attached to the TV at the factory.
2. Connect the AC cord into an AC outlet.

### WARNING

Do not connect this unit to the power using any device other than the supplied AC cord. This could cause fire, electrical shock, or damage.

Do not use with a voltage other than the power voltage specified. This could cause fire, electrical shock, or damage.

### CAUTION

When this unit is not used for a long time, (e.g., away on a trip) in the interest of safety, be sure to unplug it from the AC outlet.

Do not plug/unplug the AC cord when your hands are wet. This may cause electrical shock.

# Important Safety Instructions

## When Installing the TV Against a Wall or Enclosed Area

Make sure that your TV has adequate air circulation. Allow enough space around the TV as shown below. Avoid operating the TV at temperatures below Inadequate air 41°F (5°C).

### Install with stand

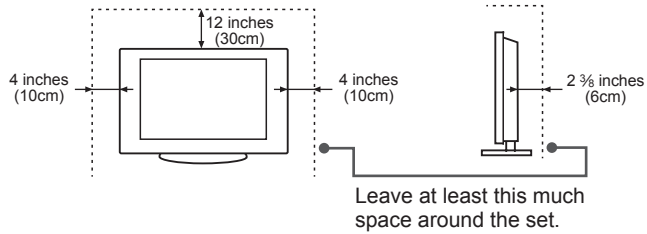

### Install on the wall

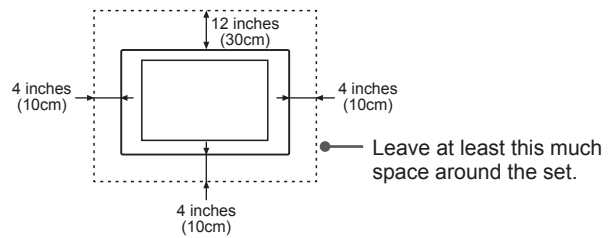

### Never install the TV set as follows:

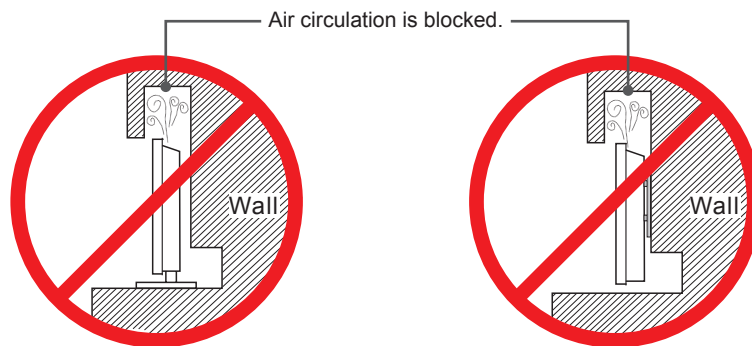

**Inadequate air circulation can lead to overheating of the TV and may cause damage to your TV or cause a fire.**

# Legal Notices

## FCC Statement

### NOTE:

This equipment has been tested and found to comply with the limits for a class B digital Device, pursuant to part 15 of the FCC Rules. These limits are designed to provide reasonable protection against harmful interference in a residential installation. This equipment generates, uses and can radiate radio frequency energy and, if not installed and used in accordance with the instructions, may cause harmful interference to radio Communications. However, there is no guarantee that interference will not occur in a particular installation. If this equipment does cause harmful interference to radio or television reception, which can be determined by turning the equipment off and on, the user is encouraged to try to correct the interference by one or more of the following measures:

- Reorient or relocate the receiving antenna.
- Increase the separation between the equipment and the receiver.
- Connect the equipment into an outlet on a circuit different from that to which the receiver is connected.
- Consult the dealer or an experienced radio/TV technician for help.

### ! WARNING

The manufacturer is not responsible for any radio or TV interference caused by unauthorized modifications to this equipment. Such modifications could void the user's authority.

This TV incorporates High-Definition Multimedia Interface (HDMI™) technology. HDMI, the HDMI logo and High-Definition Multimedia Interface are trademarks or registered trademarks of HDMI Licensing LLC.

Hisense and associated logos where applicable are registered trademarks of Hisense Group in the United States and/or other countries. All other trademarks are property of their respective owners. 2011 Hisense USA, Corporation. All Rights Reserved. Manufactured under license from Dolby Laboratories. Dolby and the double-D symbol are trademarks of Dolby Laboratories.

\* Specifications subject to change without notice.

### ENERGY STAR®

This television's factory default settings as shipped meet ENERGY STAR requirements.

This TV has an Auto Shut Off feature that will automatically turn off the TV if there is no video signals detected within 15 minutes. Additionally this TV has LED backlighting which has greater energy saving benefits versus conventional CCFL type TV.

## Energy Star

Your Hisense TV is ENERGY STAR® qualified in the "Home" mode. It meets strict energy efficiency guidelines set by the U.S. Environmental Protection Agency and Department of Energy. ENERGY STAR is a joint program of these government agencies, designed to promote energy efficient products and practices. Changes to certain features, settings, and functionalities of this TV (i.e. TV Guide, Picture, Sound) can increase or change the power consumption. Depending upon such changed settings, the power consumption may exceed the limits required for the ENERGY STAR qualification in the "Home" mode.



### ☑ NOTE

Where the MAINS plug or an appliance coupler is used as the disconnect device, the disconnect device shall remain readily operable.



# Contents

## Getting Started

|  |   |
|--|---|
| Viewing the Remote Control.....                  | 2 |
| Installing Batteries in the Remote Control ..... | 3 |
| Making Connections .....                         | 4 |

## Basic Features

|   |    |
|---|----|
| Turning Your TV On or Off .....         | 7  |
| Turning the TV for the First Time ..... | 7  |
| Selecting the Input Source .....        | 8  |
| Changing Channels / Volume .....        | 8  |
| Shortcuts Instructions .....            | 8  |
| To Use the Menu .....                   | 9  |
| Using the Picture Menu .....            | 9  |
| Using the Audio Menu .....              | 10 |
| Using the Channels Menu .....           | 10 |
| Using the Settings Menu .....           | 11 |
| Using the Parental Controls Menu.....   | 12 |

## Advanced Features

|                           |    |
|---------------------------|----|
| Digital Media Player..... | 14 |
| Enjoy Movie Files .....   | 14 |
| Browse the Photos .....   | 14 |
| Playable Format List..... | 16 |

## Trouble Shooting

|                        |    |
|------------------------|----|
| Trouble Shooting ..... | 17 |
|------------------------|----|

# Getting Started

## Viewing the Remote Control

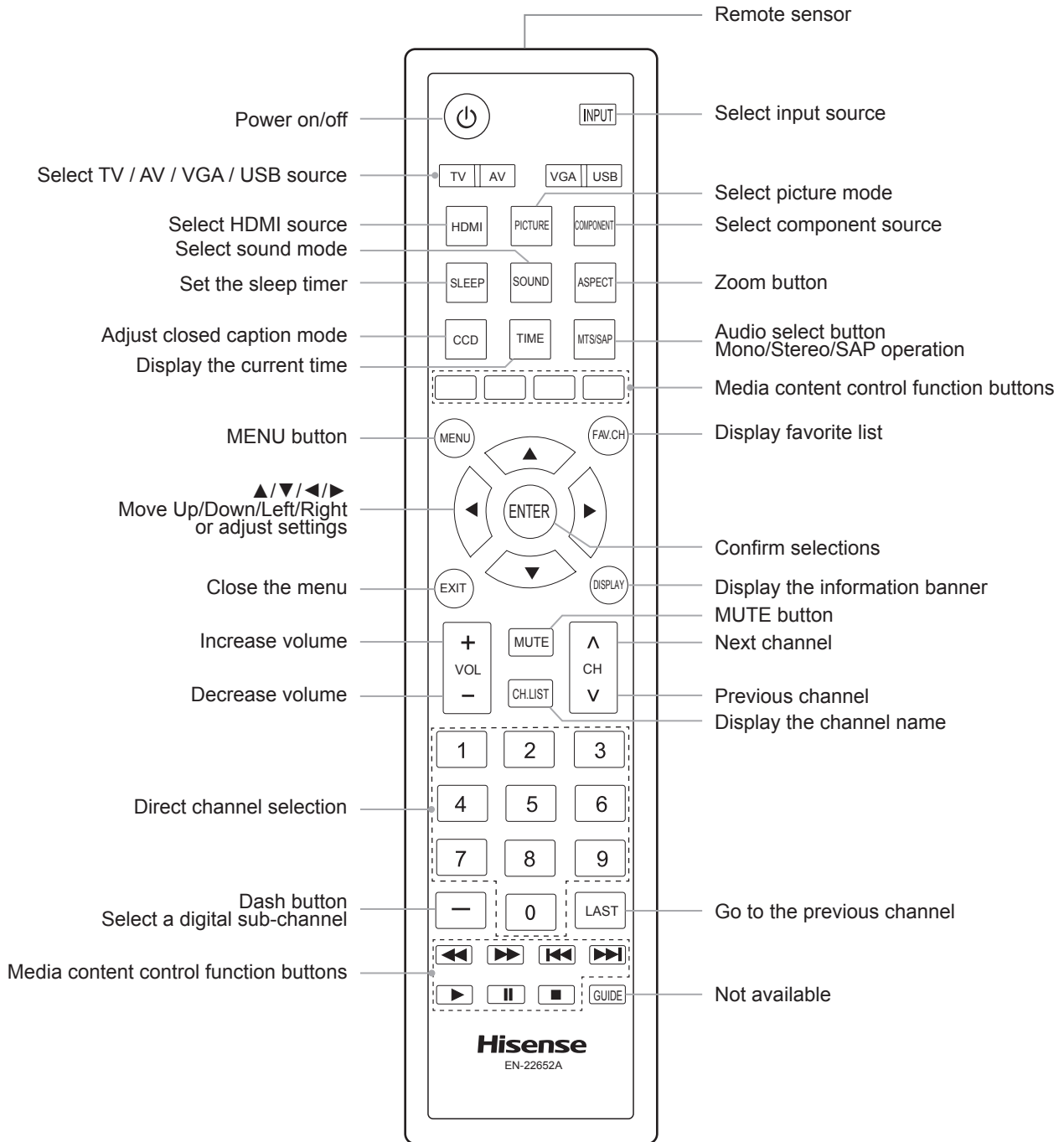

**NOTE**

The Picture is Only for Reference.



# Getting Started

## Installing Batteries in the Remote Control

### Change the batteries

1. Slide the back cover to open the battery compartment of the remote control.
2. Insert two AAA size batteries. Make sure to match the (+) and (-) ends of the batteries with the (+) and (-) ends indicated in the battery compartment.
3. Close the battery compartment cover.

The remote control requires:

- Number of Batteries: 2
- Type: AAA
- Voltage: 1,5Vcc

❶ Gently push and slide

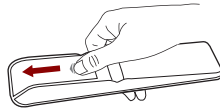

❷ Insert the batteries

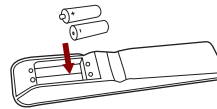

❸ Gently push and slide

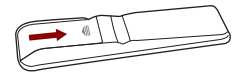

### NOTES

1. Dispose of your batteries in a designated disposal area. Do not throw the batteries into a fire.
2. Do not mix battery types or combine used batteries with new ones.
3. Remove depleted batteries immediately to prevent battery acid from leaking into the battery compartment.
4. If you do not intend to use the remote control for a long time, remove the batteries.
5. Batteries should not be exposed to excessive heat, such as sunshine, heat registers, or fire.
6. Battery chemicals can cause a rash. If the batteries leak, clean the battery compartment with a cloth. If chemicals touch your skin, wash immediately.
7. Do not mix old and new batteries.
8. Do not mix alkaline, standard (carbon-zinc) or rechargeable (ni-cad, ni-mh, etc.) batteries.

Program Your Universal Cable or Satellite Remote Control to Operate Your New Hisense Television!

If you would like to program your other household remote controls to your new Hisense television, please consult the User's Manual supplied by your Cable or Satellite provider. The Cable or Satellite providers' User's Manuals should include instructions on how to program their remote to your television.

Below is a list of Hisense codes for the most common Cable and Satellite providers. Use the Hisense code that is associated with your Cable or Satellite provider (if applicable).

DIRECTV.....0178 or 10019  
Time Warner Cable.....386 or 0178  
Comcast.....0178 or 10178  
Cox Communications.....0178  
Dish Network.....627 or 505  
AT&T U-verse.....1346

If the Hisense code associated with your Cable or Satellite provider is not listed above, if the code above does not work, or if you cannot locate the instructions for programming your household remote to your television, call your local Cable or Satellite provider's customer service center.

### The effective range of remote control

1. The remote control distance: 315 inches in front of the TV set.
2. The remote control angle: taking the television infrared light receiver window as an apex, 236 inches away, its controlled angle (left to right) is within 30 degrees, while the vertical angle (up to down) is within 30 degrees.

# Getting Started

## Making connections

### NOTES

- Check the jacks for position and type before making any connections. Loose connections can result in image or color problems. Make sure that all connections are tight and secure.
- Not all A/V devices have the ability to connect to a TV, please refer to the user manual of your A/V device for compatibility and connections procedure.
- Always unplug the power cord when connecting external equipment.

### Connecting an antenna, cable or cable/satellite box

1. Turn off the TV before connecting the antenna.
2. Connect one end of a coaxial cable (not included) to the RF OUT jack on the antenna, cable or cable/satellite box. If you are using an antenna with twin-lead cable, you may need a 300-75 ohm adapter (not provided) to connect it to the back of your TV. Likewise, if you are using several antennas, you may need a combiner (not provided).
3. Connect the other end of the cable to the ANT/CABLE jack on the side of your TV.

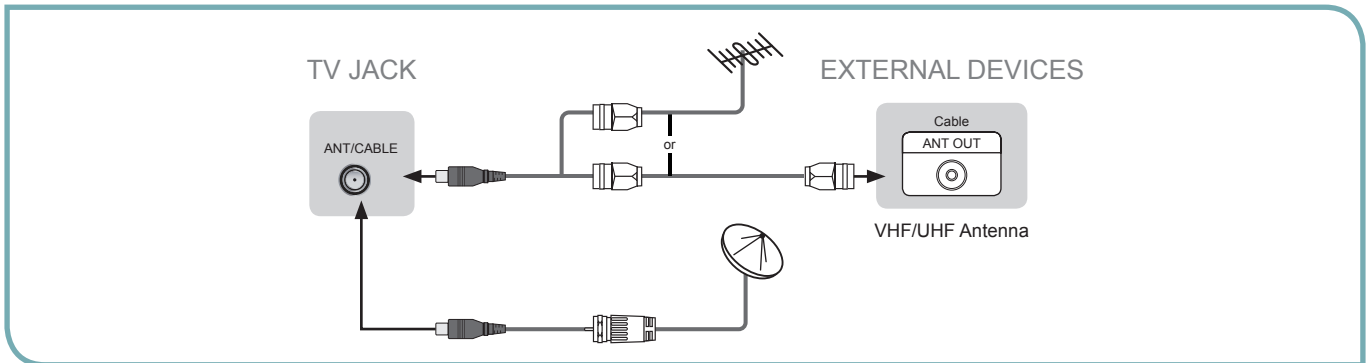

### Connecting an A/V Device with Composite Cable

1. Use the audio and video cables to connect the external A/V device's composite video/audio jacks to the TV's jacks. (Video = yellow, Audio Left = white, and Audio Right = red)
2. Plug the connected devices into the mains socket before switching on the TV.
3. Select the corresponding source from the TV.

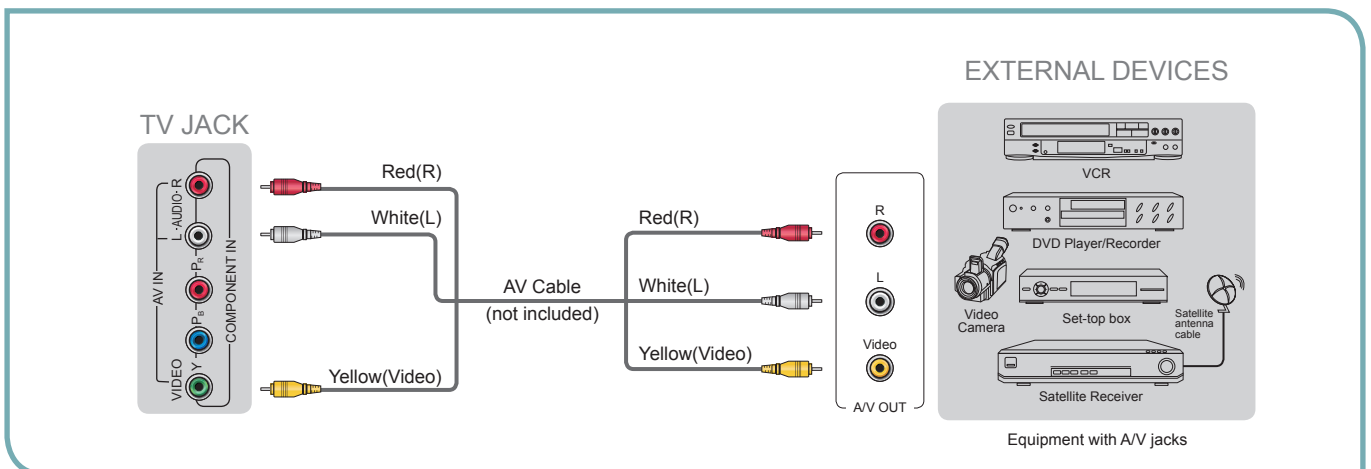

# Getting Started

## ❏ Connecting an A/V Device with Component (YP<sub>B</sub>P<sub>R</sub>) Cable

1. Use a component cable to connect the external A/V device's component output jacks to the TV's YP<sub>B</sub>P<sub>R</sub> jacks. Use an audio cable to connect the external A/V device's component audio jacks to the TV's AUDIO (L/R) jacks.
2. Plug the connected devices into the mains socket before switching on the TV.
3. Select the corresponding source from the TV.

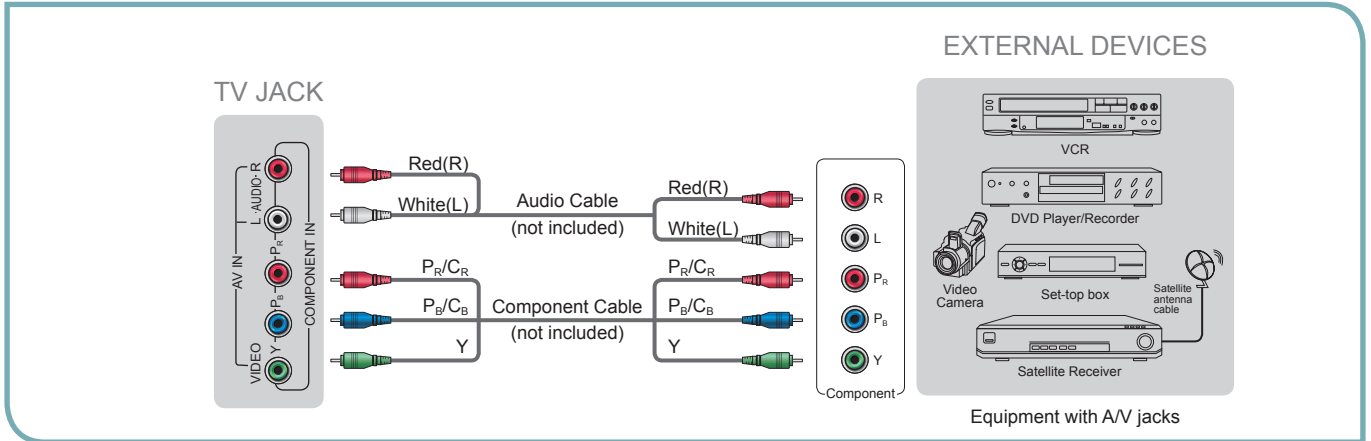

## ❏ Connecting an A/V Device with HDMI Cable

- Support digital connections between HDMI - enabled A/V devices such as PVR, DVD, Blu-ray, AV receiver and digital devices.
  - Some devices such as PVR or DVD player require HDMI signal to be set to output in the device's settings.
  - Please consult your device user manual for instructions.
1. Use an HDMI cable to connect the A/V device's HDMI output jack to the TV's HDMI jack.
  2. Plug the connected devices into the mains socket before switching on the TV .
  3. Select the corresponding source from the TV.

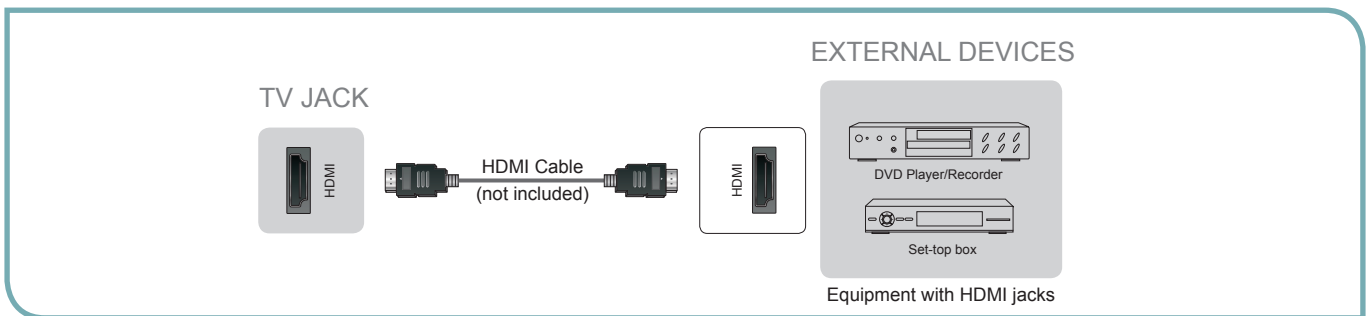

### NOTE

The HDMI connector provides both video and audio signals, it's not necessary to connect the audio cable.

## ❏ Connecting a headphone

Headphones can be connected to the /AUDIO OUT output on your set. (While the headphone is connected, the sound from the built-in speakers will be disabled.)

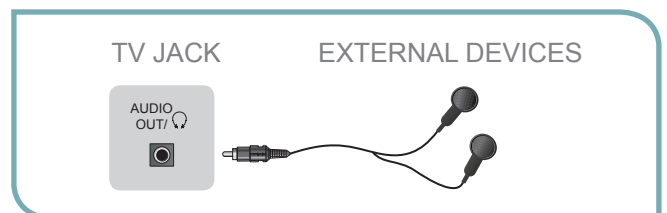

# Getting Started

## Connecting a PC with VGA Cable

1. Use a VGA cable to connect the PC's VGA output jack to the TV's VGA jack. Use an audio cable to connect the PC's audio output jack to TV's PC/DVI AUDIO IN jack.
2. Plug the connected devices into the mains socket before switching on the TV.
3. Select the corresponding source from the TV.

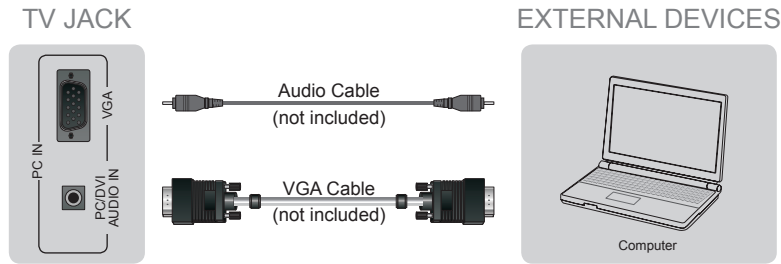

### NOTES

- Primarily this unit is intended for use as an LCD TV. If you want to use it as a monitor, please contact the manufacturer of the PC Video/Graphic's card for further support. Perfect compatibility is not warranted.
- The VGA cable will not supplied with the product.
- We strongly recommend to use VGA cable with 2 cores as shown in the figure.

## Connecting an Audio Receiver with Audio cable

1. Use an audio cable to connect the A/V device's digital audio in jack to the TV's DIGITAL OUTPUT jack. Or use an RCA Y-cable (1/8"-stereo mini to L/R phono - not provided) to connect analog sound system to the TV's AUDIO OUT jack.
2. Plug the connected devices into the mains socket before switching on the TV.
3. Select the corresponding source from the TV.

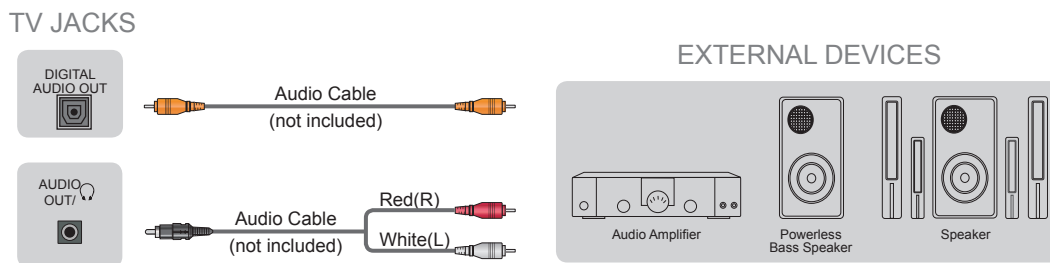

### NOTES

- When a digital audio system is connected to the DIGITAL AUDIO OUT (Optical) jack, decrease the volume of both the TV and the system.
- 5.1 CH (channel) audio is available when the TV is connected to an external device supporting 5.1 CH.
- When the receiver (home theater) is set to on, you can hear sound output from the TV's digital audio out jack. When the TV is receiving a DTV signal, the TV will send 5.1 CH sound to the home theater receiver. When the source is connected to the TV via HDMI, only 2 CH audio will be heard from the home theater receiver. If you want to hear 5.1 CH audio, connect the digital audio out jack from your DVD/Blu-ray player/cable box/STB satellite receiver directly to an amplifier or home theater.

# Basic Features

## Turning Your TV On or Off

To turn your TV on or off (standby mode):

1. Plug the power cord into an AC power outlet.
2. Press [POWER] button. Your TV turns on.
3. Press [POWER] button again to turn off your TV. When you turn off your TV, it goes into standby mode.

### ! WARNING

When your TV is in standby mode, it is still receiving power. To completely disconnect power, unplug the power cord.

### ✓ NOTE

If your TV does not receive an input signal for several minutes, it automatically goes into standby mode.

## Turning the TV On for the First Time

The Setup Wizard menu appears the first time you turn on the TV. It will assist you to specify the menu language, Picture Mode, TV Source and Channel Installation.

**IMPORTANT: Make sure that the antenna or cable is connected.**

1. Make sure that you have:
  - Installed batteries into the remote control .
  - Connected an antenna or cable.
  - Connected the power cord.
2. Connect your TV's power cord to a power outlet, then press power. The initial setup screen opens. Press [▲/▼] button to select your language, press [ENTER] button to confirm.

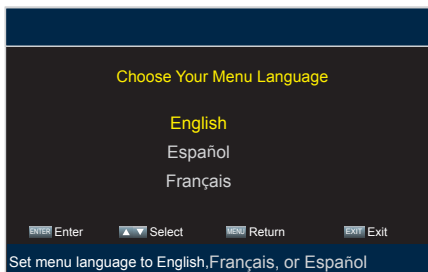

3. Press [▲/▼] to select your options and press [◀/▶] to set the options.

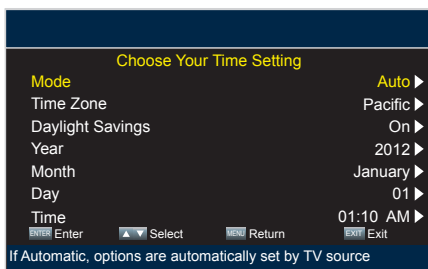

- If Auto selected, the options of Year/Month/Day/Time are not available.
  - Setting the Time: Press [◀/▶] to select the number you want to set and press [▲/▼] to set.
4. Press [▲/▼] to select your Picture Mode: Home Mode or Retail Mode, press [ENTER] button to confirm.

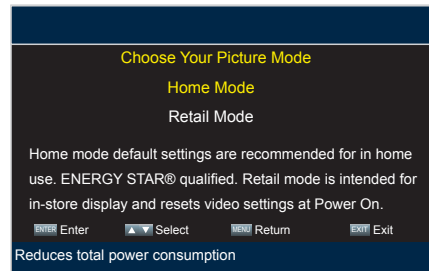

If you select Retail Mode, a message appears "Are you sure you want retail mode?" Select "Yes" to continue, or select "No" to change your selection.

5. Press [▲/▼] to select your TV Source: Antenna or Cable, press [ENTER] button to confirm.

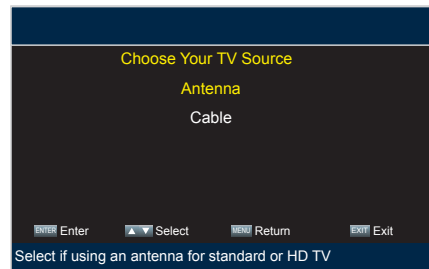

- Then your TV automatically starts Channel Installation available in your viewing area.

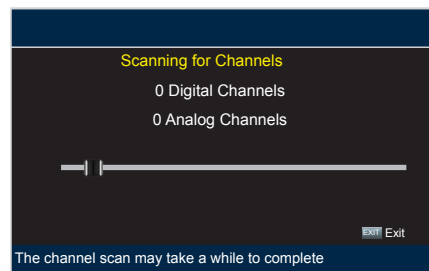

- Depending on the reception condition, it may take several minutes to scan channels. Please allow the process to complete without interruption.
- If you press [EXIT] to exit the scanning, a message appears "Please Run Channel Auto Scan", you should scan channels from the menu of Channels

# Basic Features

## Selecting the Input Source

The first time you turn on your TV, you must select the TV signal source. Your TV stores this information, so you do not need to change the TV signal source unless it changes. For example, you change from an outside antenna to cable TV.

### To select the video input source:

1. Turn on your TV, then press [INPUT] button on the remote or on the TV. The Input source menu opens.
2. Press [▲/▼] button to highlight the input source, then press [ENTER] button.

## Changing Channels / Volume

1. Press the [CH ▲/▼] (or [CH +/-]) on the TV/remote control to change the channel.
2. Press the [VOL ▲/▼] (or [VOL +/-]) on the TV/remote control to adjust the volume.
3. Press the numeric buttons on the remote control to display the corresponding channels.

### NOTE

Changing the channels can also be achieved by directly entering the channel number using the numeric keys on the remote control. If you are entering a two or three digit channel number, the time between key presses should be less than 3 seconds.

## Shortcuts Instructions

**Aspect** - Select the screen aspect ratio from Normal, Wide, Auto, Zoom, Cinema and 1:1 PIXEL MAP.

**Normal:** The original 4:3 aspect ratio (1.33:1 signal) is preserved, so black bars are added to the left and right of the image. Standard TV broadcasts are displayed with a 4:3 aspect ratio.

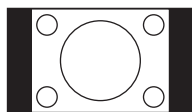

**Wide:** When watching a standard broadcast or full-frame movie in this mode, the display image is stretched proportionately to fill the TV screen. When watching a widescreen (1.78:1 signal) program or movie, the display image fills the TV screen.

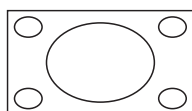

**Auto:** Automatically adjusts the image based on the screen size and the TV program.

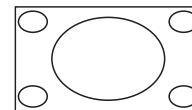

**Zoom:** Stretch the 4:3 aspect ratio image vertically and horizontally to fill the screen at 1:1.78 aspect ratio.

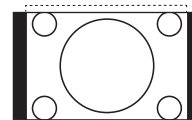

**Cinema:** Stretch the 4:3 aspect ratio image vertically and horizontally to fill the screen at 1:2.35 aspect ratio.

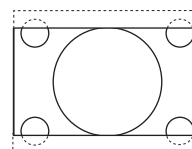

**1:1 PIXEL MAP (VGA and HDMI(RGB) only):** Detect the resolution of the signal and display an image with the same number of pixels.

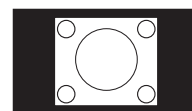

### NOTE

The aspect ratio varies with different sources.

**Picture** - Press to set the picture mode. It can be set as Vivid, Standard, Theater, Energy Savings or Custom. This mode achieves a certain image display effect by setting the brightness, contrast and color etc.

**Sound** - Press to set the sound mode. It can be set as Standard, Theater, Music, Speech and Custom.

**Mute** - Press to turn the sound off, press this button again to turn the sound back on. This function is used to switch off sound temporarily.

**Sleep** - It can set the TV to let it enter into the Standby state automatically. Press this button repeatedly to select the proper sleeping clock mode, and the clock tells you the remaining time before the TV enters Standby state.

**Display** - Display the information banner. The information including channel number, channel name, current system time, tuner mode, audio stream, video format, audio language, closed caption mode, parental locks rated, program details, etc.

# Basic Features

## To Use the Menu

- 1 Press [MENU] to open the main menu.
- 2 Press [▲/▼] to select a menu option, then press [▶/ENTER] button to enter the menu.
- 3 In each menu, you can:
  - Press [▲/▼] to select an item,
  - Press [◀/▶] to adjust the value, or
  - Press [▶/ENTER] to enter the submenu,
  - Press [MENU] to back the previous menu.
- 4 Press [EXIT] to exit the menu.

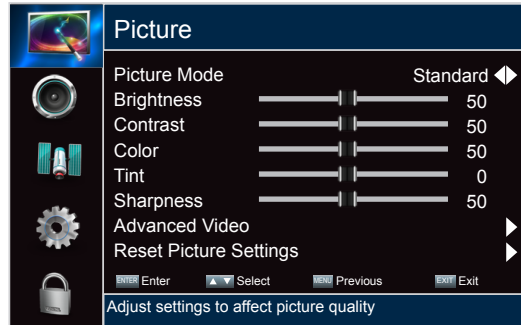

### NOTE

The menus in the user manual may vary slightly from the actual screen.

## Using the Picture Menu

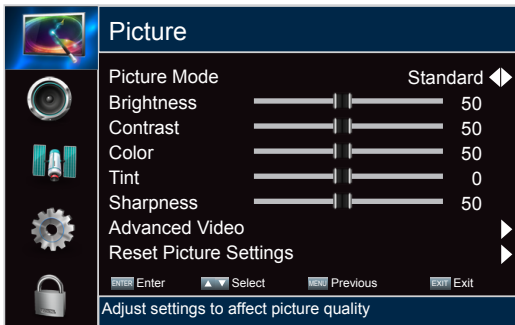

### You can adjust:

**Picture Mode** - Adjust the Picture Mode. You can select Vivid, Standard, Theater, Energy Savings or Custom.

**Brightness** - Increase or decrease the brightness of the picture. Increasing the brightness can add more light to dark areas of the picture, while decreasing the brightness can add more darkness to light areas of the picture.

**Contrast** - Increase or decrease the contrast of the picture. Increase the contrast to adjust the white areas of the picture or decrease the contrast to adjust the black areas of the picture.

**Color** - Adjusts the color intensity of the picture. A low setting may make the color look faded. A high setting may make the color look artificial.

**Tint** - Adjusts the color balance of the picture. Use this control to make skin tones look more natural.

**Sharpness** - You can increase the sharpness level for clearer images or decrease the sharpness level for smoother images.

**Advanced Video** - Access advanced video settings such as Backlight, Color Temperature and Noise Reduction.

**Dynamic Backlight Control:** Enhances the contrast ratio between light and dark areas of the picture. You can select Off, Low, or High.

**Backlight:** Sets the overall brilliance of the screen. When the option of **Dynamic Backlight Control** is turned Low or High, you cannot change the Back Light setting.

**Aspect Ratio:** To choose the screen aspect ration from Wide, Cinema, Auto, Normal, 1:1 PIXEL MAP and Zoom .

### NOTE

The option of the screen Aspect Ration is different in different inputs. (For more information, see "Shortcuts Instructions")

**Color Temperature:** Change the color temperature. You can select the color temperature from three options: Cool, Normal or Warm.

**Overscan:** Adjusts the picture's reproduction rate. You can select On or Off.

### NOTE

Only available in DTV, Component and HDMI(YUV) source.

**Noise Reduction:** Select to reduce the noise level of connected equipment: off, Low, Medium and High.

**Adaptive Contrast:** Automatically adjusts picture detail and brightness. You can select On or Off.

**120Hz Effect:** Inserts frames to reduce judder in fast action scenes. You can select On or Off.

### NOTE

Only available in the models that support 120 Hz.

**Reset Picture Settings** - Resets all Picture Settings to the factory defaults.

# Basic Features

## Using the Audio Menu

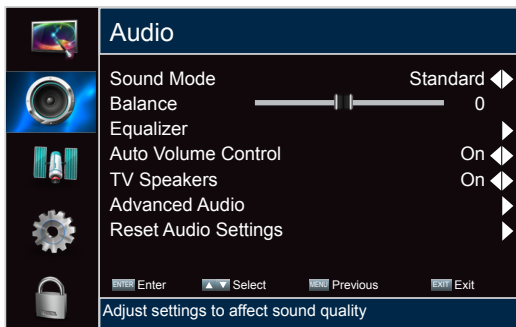

### You can adjust:

**Sound Mode** - Select the Sound Mode: Standard, Theater, Music, Speech or Custom.

**Balance** - Adjust the volume of the left and right speakers.

**Equalizer** - Soften or enhance the sound at specific frequency points.

**Auto Volume Control** - Automatically adjusts volume to a consistent level; attenuates loud passages.

**TV Speakers** - Selects where to play TV audio. You can select On (default setting) to play audio through TV speakers, or select Off to play audio through the speakers on an external audio system.

**Advanced Audio** - Access Advanced Audio settings such as Digital Audio Out, MTS/SAP, Audio Language.

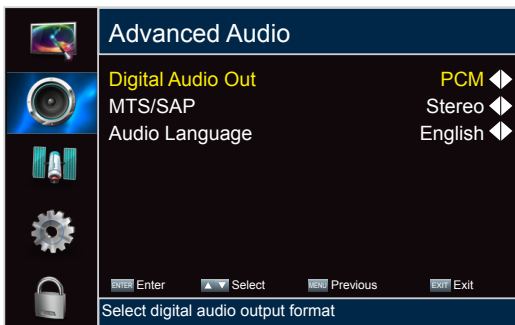

**Digital Audio Out:** Send digital audio to an external audio system. You can select PCM, RAW or Off.

- **PCM:** PCM outputs two channel audio regardless of the input format.
- **RAW:** When the data stream carries Dolby signal, digital SPDIF outputs Dolby data stream. When the data stream carries no Dolby signal, it transports PCM data stream.

**MTS/SAP (Analog channels only):** Select the default audio stream, you can select Mono, Stereo or SAP (Second Audio Program).

- **Mono:** Select this option if there is noise or static on weak stereo broadcasts.
- **Stereo:** Select this option for programs broadcast in stereo.

- **SAP:** Depending on the particular program being broadcast, you can listen to a foreign-language translation.

**Audio Language** (Digital channels only) - Change the default value for audio language.

**Reset Audio Settings** - Resets all audio settings to the factory defaults.

## Using the Channels Menu

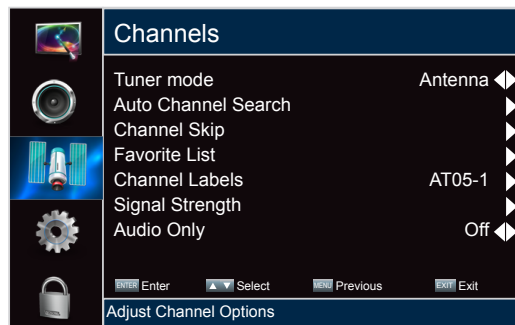

### You can adjust:

**Tuner Mode** - Select the TV signal source. You can select Antenna or Cable.

**Auto Channel Search** - Scans for channels that have signals and stores the channels information in memory.

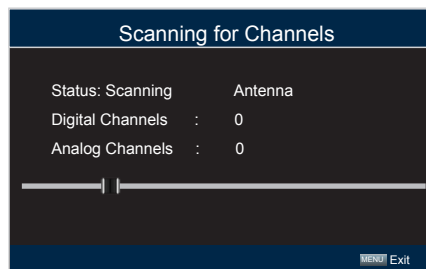

**Digital Channels:** The scanned TV program in digital signals.

**Analog Channels:** The scanned TV program in analog signals.

**Channel Skip** - You can hide channels in the channel list. Press [▲/▼] to select the channels you want to hide and press [ENTER] to confirm.

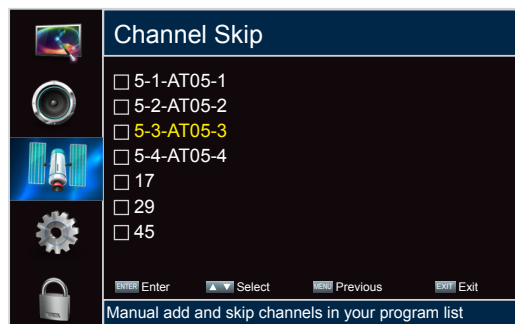



# Basic Features

## NOTE

When you press [CH  $\wedge$ /V] (or [CH +/-]) button, your TV skips the hidden channels. You can still tune to the channel by pressing the number buttons on the remote control.

**Favorite List** - Display your Favorite List. You can add or delete channels to create your favorite list.

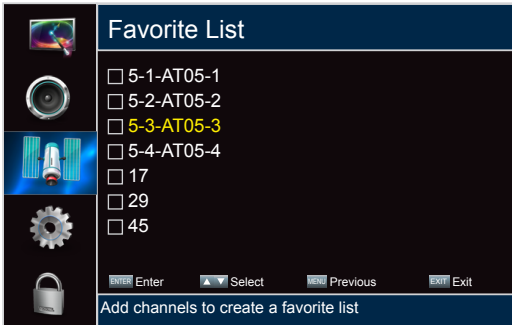

**Channel Labels** - Change the channel name. Press [◀/▶] to select the character you want to change, then press [▲/▼] to set the character.

**Signal Strength** (Digital channels only)- You can check the digital signal strength to determine if you need to adjust your antenna or digital cable input.

**Audio Only** - Listen to the program audio only, when you turn off the picture on your TV.

## NOTES

- Audio Only works only when the input source is TV, and your TV is receiving a broadcast signal.
- To exit audio only mode, press any button. When you exit audio only mode, the Audio Only option is automatically reset to Off.

## Using the Settings Menu

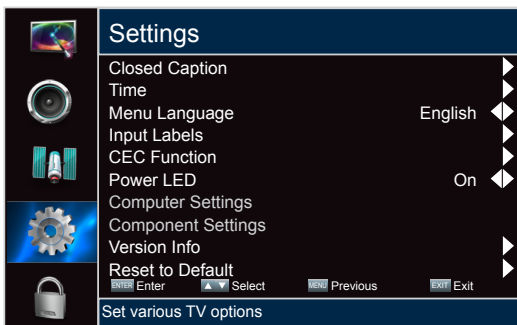

**You can adjust:**

**Closed Caption** - Adjust Closed Caption settings.

**Closed Caption:** To select CC Off (turns off closed caption), CC On (turns on closed caption), or CC on when Mute (turns on closed caption when the sound is muted).

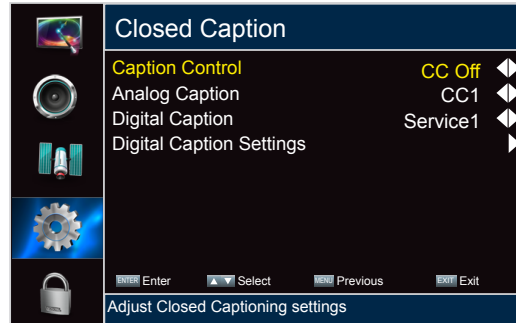

**Analog Caption:** Select an Analog Caption setting from CC1~CC4, TEXT1~TEXT4, Off.

**Digital Caption:** Select a Digital Caption setting: Service1~Service6, Off.

**Digital Caption Settings:** There are two Caption Styles. One is the automatic function set as the broadcaster, while the other is the custom style where you can adjust the font size, color, opacity, background color etc..

**Time** - Access Time settings such as Time Zone, Date/Time, Sleep Timer.

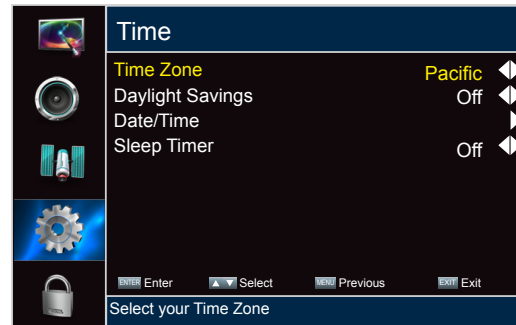

**Time Zone:** Select your local time zone: Pacific, Alaska, Hawaii, Newfoundland, Atlantic, Eastern, Central and Mountain.

**Daylight Savings:** Press [▲/▼] to highlight Daylight Savings, then press [◀/▶] to select On (if your viewing area observes Daylight Savings Time) or Off (if your viewing area does not observe Daylight Savings Time).

**Date/Time:** You can set time manually or select automatic if the TV is connected to an antenna or cable source.

- **Auto synchronization:** Select Manual (to set the date and time manually) or Auto (to set the date and time automatically from a TV signal source based on the time zone you select).

If you selected Manual, set the following options.

- **Date:** Set the current year/month/day.
- **Time:** Set the current time.

**Sleep Timer:** Specify the amount of time before your TV automatically turns off.

**Menu Language** - You can select the menu's language to English, Spanish or French.

# Basic Features

**Input Labels** - Press [▲/▼] to select the input source you want to label, then press [▶] to move to the custom label field and then press [▲/▼] to select the character you want. When you have completed the label, The next time you press INPUT, your label will appear in the Input source list.

**CEC Function**- CEC Function lets you control HDMI CEC-compatible devices connected to the HDMI jacks on your TV using the remote control that came with your TV. To use CEC Function, you must set the CEC Control setting to On.



## NOTES

- HDMI cables must be used to connect HDMI CEC-compatible devices to your TV.
- The connected device's HDMI CEC feature must be turned on.
- If you connect an HDMI device that is not HDMI CEC-compatible, all the CEC Control features do not work.
- Depending on the connected HDMI device, the CEC Control feature may not work.

**CEC Control:** Turning CEC Function on or off.

**Device Auto Power Off:** When HDMI-CEC is turned on, Device Auto Power Off turns off HDMI CEC devices when you turn off your TV.

**TV Auto Power On:** When CEC is turned on and you turn on an HDMI CEC device, TV Auto Power On turns on your TV automatically.

**Audio Receiver:** When CEC is turned on and you have connected an audio receiver to your TV, turning on Audio Receiver lets you use your TV's remote control to control the volume on the audio receiver.

**CEC Device Lists:** You can display a list of HDMI CEC devices that are connected to your TV and select the source you want.

**Connect:** Connect to the current CEC devices .

**Root Menu:** You can open an CEC-compatible device's root menu, then use your TV's remote control to control the device.

**Power LED** - To turn on or off the standby indicator.

**Computer Settings (Only available in VGA mode.)**- Access Computer Settings such as H.Position, V.Position, Clock, Phase and Auto Adjust.

**Auto Adjust:** Detects input signal clock, phase and position and adjusts TV display accordingly.

**H.Position:** Move the image right or left.

**V.Position:** Move the image up or down.

**Clock:** Adjust the sample frequency.

**Phase:** Adjust the focus of stable images.

**Reset Computer Settings:** Resets all computer settings to factory mode.

**Component Settings (Only available in Component mode.)** - You can adjust the horizontal distortion that may occur when watching video from a component video device.

**Phase:** Minimizes horizontal distortion.

**Reset Component Settings:** Resets all component video settings to factory mode.

**Version Info** - Display the software version information.

**Reset to Default** - Every TV has its original setting before leaving the factory. This function can help you restore these settings.

## Using the Parental Controls Menu

When you first use this function, the default password is [0000]. Once you input this password, you can set options.



**You can adjust:**

**Button Lock** - Block or unblock the button of the TV.

**Block Unrated TV** - Block unrated TV programs.

**USA Parental Locks** - Restrict movie and TV programs for USA Ratings.

**Canadian Parental Locks** - Restrict movie and TV programs for Canadian Ratings.

**Change Password** - If you want to change the default password, first enter the new password then enter the same password again.

**Open V-Chip** - Display an advanced V-Chip ratings table for digital channels (USA only).

**Reset Parental Control Settings** - Resets all parental control settings to factory mode.

**Clean All** - Reset all your settings to factory mode.

# Basic Features

Following is the description of these ratings.

## U.S. TV Ratings

| Age   | Defined as                  |
|-------|-----------------------------|
| TV-Y  | All children                |
| TV-Y7 | Directed to older children  |
| TV-G  | General audience            |
| TV-PG | Parental Guidance suggested |
| TV-14 | Parents Strongly cautioned  |
| TV-MA | Mature Audience only        |

| Contents | Defined as   |
|----------|--|
| ALL      | All of the ratings below that rating set blocked automatically |
| D        | Suggestive dialogue  |
| L        | Strong language  |
| S        | Sexual situations  |
| V        | Violence   |
| FV       | Fantasy Violence   |

## U.S. Movie Ratings

| Rating | Defined as                   |
|--------|------------------------------|
| G      | General audience             |
| PG     | Parental Guidance suggested  |
| PG-13  | Parents strongly cautioned   |
| R      | Restricted                   |
| NC-17  | No one 17 and under admitted |
| X      | Adult audience only          |

## Canadian English Ratings

| Rating | Description                                     |
|--------|---|
| C      | Children  |
| C8+    | Children 8 years and older                      |
| G      | General Programming, suitable for all audiences |
| PG     | Parents Guidance                                |
| 14+    | Viewers 14 years and older                      |
| 18+    | Adult Programming                               |

## Canadian French Ratings

| Rating  | Description  |
|---------|--|
| G       | General  |
| 8 ans+  | 8+General; Not recommended for young children                    |
| 13 ans+ | Programming may not be suitable for children under the age of 13 |
| 16 ans+ | Programming is not be suitable for children under the age of 16  |
| 18 ans+ | Programming restricted to adults                                 |

### NOTE

As you block rating, all rating higher than the ones you select are blocked as well. E.g. if you choose to block the MPAA rating R, the higher ratings, NC-17 and X, are automatically blocked too.

# Advanced Features

## Digital Media Player

Please note that Hisense will not assume any responsibility for any lost data and cannot guarantee perfect compatibility with all mass storage devices. Be sure to insert the USB disk with standard USB 2.0 port. Data Input from USB Memory Stick only. Do not connect any device to this terminal such as digital camera, keyboard, mouse, etc.

### NOTE

Never remove the USB flash drive or turn off your TV while viewing video/photo.

- Press [INPUT] button to display the INPUT menu, press [▲/▼] button to highlight the USB source, then press [ENTER] button to confirm. (If you want to exit DMP, you can press [INPUT] button to switch to other sources).
- Press [RED] button to switch the media type.
- Press [YELLOW/BLUE] button to turn to the previous/next page.

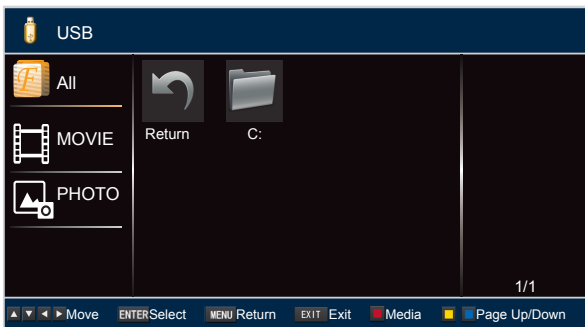

### Media content control function buttons

When viewing video/photo, you can press these buttons on the remote control to control video/photo.

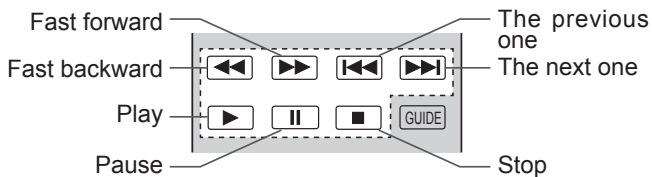

## Enjoy Movie Files

1. Press [RED] button to switch the media type to MOVIE.
2. Press [▲/▼/◀/▶] to select the movie you want to view.
3. Press [ENTER] to play the movie.
4. Press [EXIT] to exit the video and return to the previous directory.
5. When enjoying the video, press [MENU] button to display/exit the tool bar. Press [▶/ENTER] to enter the submenu and press [EXIT] to return to the upper menu.

### Tool bar

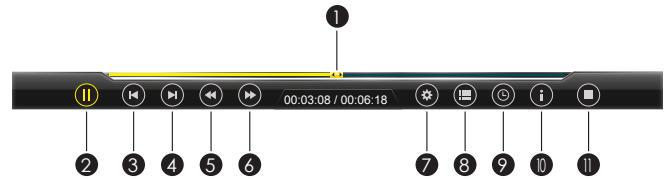

- ① Progress bar.
  - ② Play/Pause the video.
  - ③ Play the previous video.
  - ④ Play the next video.
  - ⑤ Fast backward. Press [ENTER] to select the backward speed.
  - ⑥ Fast forward. Press [ENTER] to select the forward speed.
  - ⑦ Options. Adjust Repeat Mode, Zoom Mode, Audio Track, and Subtitle.
  - ⑧ Play list. You can select the video you want to view, then press [ENTER] to play.
  - ⑨ Select time to play. Press [◀/▶] to select the position you want to set, press [0~9] to set the time (or press [▲/▼] to adjust it), then press [ENTER] to confirm and the video will to play at the time you have set.
  - ⑩ Video Info. Displays details on image resolution, audio and video code, subtitle, audio track, program and time.
  - ⑪ Stop playback.
6. Press [ASPECT] button one or more times to enlarge the image by Wide and Normal.

# Advanced Features

## Browse the Photos

1. Press [RED] button to switch the media type to PHOTO.
2. Press [▲/▼/◀/▶] to select the photo you want to view.
3. Press [ENTER] to browse the photo.
4. Press [EXIT] to return to the previous directory.
5. When browsing photos, press [MENU] button to display / exit the tool bar. Press [▶/ENTER] to enter the submenu and press [EXIT] to return to the upper menu.

### ● Tool bar

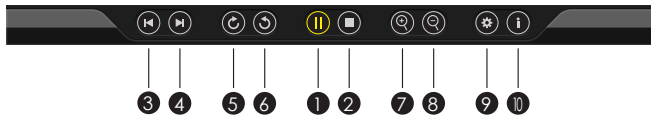

### ☑ NOTE

When the photos in browsing or pausing, the menu will be different.

- 1 Play/Pause the photo.
- 2 Stop browsing the photo.
- 3 Browse the previous photo.
- 4 Browse the next photo.
- 5 Allows the photo to rotate 90 degrees clockwise.
- 6 Allows the photo to rotate 90 degrees anti-clockwise.
- 7 Zoom in the photo.
- 8 Zoom out the photo.
- 9 Options. You can adjust Show Speed.
- 10 Photo Info. Allows you to view the photo information.

### ☑ NOTES

- The unit recognizes only a USB Memory Stick.
- Do not use a USB hub or an extension cable to connect an external hard disk drive to the unit. (Not supported)
- A USB Memory Stick is always inserted to this unit directly.
- A USB Memory Stick is not supplied with this unit.
- We do not guarantee that all USB Memory Sticks can be supported by this unit.
- Be sure to keep a backup copy of the original files on your device before you play them back on this unit. We have no responsibilities for damage or loss of your stored data.
- To protect your USB Memory Stick files from being erased place the write protect sliding tab in the protect position.
- When you are ready to remove a USB Memory Stick, set the unit to go into Standby mode to avoid any damage to your data and the unit.
- A USB Memory Stick that requires its own driver or the device with a special system such as fingerprint recognition are not supported.
- This unit is not allowed to use the USB Memory Stick which requires an external power supply (500mA or more).

# Advanced Features

## Playable Format List

### Video Decoder Support List

| <i>File extension</i> | <i>Container</i> | <i>Video Decoder</i> | <i>Resolution</i> | <i>Bitrate (bps)</i> |
|-----------------------|------------------|----------------------|-------------------|----------------------|
| *.avi                 | AVI              | MPEG1                | 768*576           | 1.8M                 |
|                       |                  | MPEG2 MP@HL          | 1920*1080         | 40M                  |
|                       |                  | MPEG-4 SP@HL 3.0     | 1920*1080         | 40M                  |
|                       |                  | MPEG-4 ASP@HL 4.0    | 1920*1080         | 40M                  |
| *.wmv                 | ASF              | MPEG-4 SP@HL 3.0     | 1920*1080         | 40M                  |
| *.asf                 |                  | MPEG-4 ASP@HL 4.0    | 1920*1080         | 40M                  |
| *.mp4                 | MP4              | MPEG-4 SP@HL 3.0     | 1920*1080         | 40M                  |
| *.mov                 |                  | MPEG-4 ASP@HL 4.0    | 1920*1080         | 40M                  |
| *.3gp                 |                  |                      |                   |                      |
| *.mkv                 | MKV              | MPEG-4 SP@HL 3.0     | 1920*1080         | 40M                  |
|                       |                  | MPEG-4 ASP@HL 4.0    | 1920*1080         | 40M                  |
| *.mpg                 | PS               | MPEG1                | 768*576           | 1.8M                 |
| *.mpeg                |                  |                      |                   |                      |
| *.vro                 |                  | MPEG2 MP@HL          | 1920*1080         | 40M                  |
| *.vob                 |                  |                      |                   |                      |
| *.ts                  | TS               | MPEG2 MP@HL          | 1920*1080         | 40M                  |
| *.ogm                 | OGG              | MPEG2 MP@HL          | 1920*1080         | 40M                  |
|                       |                  | MPEG-4 SP@HL 3.0     | 1920*1080         | 40M                  |
|                       |                  | MPEG-4 ASP@HL 4.0    | 1920*1080         | 40M                  |

### Audio Decoder Support List

| <i>File extension</i> | <i>Container</i> | <i>Audio Decoder</i> |
|-----------------------|------------------|----------------------|
| *.avi                 | AVI              | MPEG1 Layer1/2       |
|                       |                  | MPEG2 AAC            |
|                       |                  | MPEG4 AAC-LC         |
|                       |                  | MPEG4 HE-AAC AC3     |
| *.MP4                 | MP4              | MPEG1 Layer1/2       |
|                       |                  | MPEG2 AAC            |
|                       |                  | MPEG4 AAC-LC         |
|                       |                  | MPEG4 HE-AAC         |
| *.mpg                 | PS               | MPEG1 Layer1/2       |
| *.mpeg                |                  |                      |
| *.vro                 |                  |                      |
| *.vob                 |                  | AC3                  |
| *.ts                  | TS               | MPEG1 Layer1/2       |
|                       |                  | MPEG2 AAC            |
|                       |                  | MPEG4 AAC-LC         |
|                       |                  | MPEG4 HE-AAC AC3     |
| *.rm                  | RM               | MP3                  |
|                       |                  | MPEG2 AAC            |
| *.mkv                 | MKV              | MPEG1 Layer1/2       |
|                       |                  | MPEG2 AAC            |
|                       |                  | MPEG4 AAC-LC         |
|                       |                  | MPEG4 HE-AAC AC3     |

# Trouble Shooting

**When there is something wrong with your TV, you can try turning off the TV and then restart it. You can also Operate according to the following chart. If the problem still cannot be solved, please contact the professional technicians.**

| <b><i>SYMPTOMS</i></b>  | <b><i>POSSIBLE SOLUTIONS</i></b>   |
|---|--|
| No sound or picture.  | <ul style="list-style-type: none"> <li>● Check if the power cord is in the AC outlet and if it has electricity.</li> <li>● Check if you have pressed [POWER] button on the TV or [POWER] button on the remote control.</li> <li>● Check to see if LED light is either red or blue. If illuminated, power to TV is OK.</li> </ul> |
| I have connected an external source to my TV and I get no picture and/or sound.                       | <ul style="list-style-type: none"> <li>● Check for the correct output connection on the external source and for the correct input connection on the TV.</li> <li>● Make sure you have made the correct selection for the input mode for the incoming signal.</li> </ul>  |
| When I turn on my television, there is a few second delay before the picture appears. Is this normal? | Yes, this is normal. That is the TV searching for previous setting information and initializing the TV.  |
| Picture is normal, but no sound.  | <ul style="list-style-type: none"> <li>● Check the volume settings.</li> <li>● Check if Mute mode is set "on".</li> </ul>  |
| Sound but no picture or black and white picture.  | <ul style="list-style-type: none"> <li>● If black and white picture first unplug TV from AC outlet and replug after 60 seconds.</li> <li>● Check Color Setting if picture is black and white.</li> </ul>   |
| Sound and picture distorted or appear wavy.   | <ul style="list-style-type: none"> <li>● An electrical appliance may be affecting TV set. Turn off any appliances, if interference goes away, move appliance farther away from TV.</li> <li>● Insert the power plug of the TV set into another power outlet.</li> </ul>  |
| Sound and picture is blurry or cuts out momentarily.  | <ul style="list-style-type: none"> <li>● If using an external antenna, check the direction, position and connection of the antenna.</li> <li>● Adjust the direction of your antenna or reset or fine tune the channel.</li> </ul>  |
| Horizontal/vertical stripe on picture or picture is shaking.  | Check if there is interfering source nearby, such as appliance or electric tool.   |
| The plastic cabinet makes a "clicking" type of sound.   | "Click" sound can be caused when the room temperature changes. This change causes the television cabinet to inflate or contract, which makes the sound. This is normal and TV is OK.   |
| Black square appears in the center of my television screen?   | The Closed Caption function is set in the text mode. To remove it, access Closed Caption from the menu screen and change the Mode setting from text to either CC1 or off .   |

## Trouble Shooting

| <i><b>SYMPTOMS</b></i>  | <i><b>POSSIBLE SOLUTIONS</b></i>   |
|---|--|
| On some channels getting another language or sometimes no sound at all.                       | <p>That would indicate that the MTS mode on your unit is set to SAP mode. We suggest setting the MTS mode to either Stereo or Mono . For further instruction, please see Audio Adjust or MTS/SAP in your user manual.</p> <ul style="list-style-type: none"> <li>● SAP is Second Audio Program. It's a second audio channel that is usually used for a second language or descriptive audio for the visually impaired.</li> <li>● MTS stands for Multichannel Television Sound, a standard that allows the encoding of 3 channels of audio within a standard NTSC (analog) video signal to a television. A television that is able to receive MTS Stereo allows you to watch television with stereo sound.</li> </ul>  |
| Not getting all of my cable channels on the television or I'm only getting 13 channels.       | <ul style="list-style-type: none"> <li>● Check the cable connection for an incoming signal. Make sure the signal is coming OK. Best way to confirm signal is to use another TV and/or contact your cable company.</li> <li>● Reprogram your channels. Press [MENU] button on your TV remote control, change Input Source setting to "Cable", then use "Auto Channels Search" to reprogram your channels.</li> </ul>  |
| [CH $\wedge$ / V] don't work when I set the Channel to Cable? They work with the Air setting? | <p>After switching to Cable, please auto program the channels. The TV will "remember" all the channels then the TV will allow you to surf the channels with [CH <math>\wedge</math>/V] buttons.</p>  |
| Remote control does not work.   | <ul style="list-style-type: none"> <li>● Confirm that TV still has power and is operational.</li> <li>● Change the batteries in the remote control.</li> <li>● Check if the batteries are correctly installed.</li> <li>● Clean the front of the remote control (LED window).</li> <li>● If using a universal remote, be sure to select the TV mode on the remote.</li> <li>● If the remote still does not work: <ul style="list-style-type: none"> <li>• Remove and reinstall the batteries correctly to reset the remote or install new batteries.</li> <li>• Press the Power button to turn on the TV. With a universal remote if you have reset or changed the batteries you will need to reprogram the remote for the other units.</li> </ul> </li> <li>● Check if there is obstruction between the remote control and the TV.</li> </ul> <p><b>TIP:</b> If you have a digital camera / camera phone, you can aim the front of the remote at camera lenses (at this time, the camera should set on camera mode, not play mode). Observe the camera screen while pressing a button on the remote control; you should see flashing light on the screen. If there is no light observed, the remote control is not working. You need to repair or replace the remote control.</p> |