



**DUAL BAND
HEAVY DUTY SUBMERSIBLE TRANSCEIVER**

VX-6E

OPERATING MANUAL



VERTEX STANDARD CO., LTD.
4-8-8 Nakameguro, Meguro-Ku, Tokyo 153-8644, Japan

VERTEX STANDARD
US Headquarters
10900 Walker Street, Cypress, CA 90630, U.S.A.

YAESU EUROPE B.V.
P.O. Box 75525, 1118 ZN Schiphol, The Netherlands

YAESU UK LTD.
Unit 12, Sun Valley Business Park, Winnall Close
Winchester, Hampshire, SO23 0LB, U.K.

VERTEX STANDARD HK LTD.
Unit 5, 20/F., Seaview Centre, 139-141 Hoi Bun Road,
Kwun Tong, Kowloon, Hong Kong

Contents

General Description	1	Scanning	46
Accessories & Options	2	VFO Scanning	47
Controls & Connections	3	Setting the Squelch Level during activate Scanning Operation	48
Top & Front Panel	3	How to Skip (Omit) a Frequency during VFO Scan	48
LCD	4	Memory Scanning	49
Side & Bottom Panel	5	How to Skip (Omit) a Channel during Memory Scan	49
Keypad	6	Preferential Memory Scan	50
Installation of Accessories	8	Memory Bank Scan	51
Antenna Installation	8	Programmable (Band Limit) Memory Scan (PMS)	52
Belt Clip & Hand Strap Installation	8	“Priority Channel” Scanning (Dual Watch)	53
Installation of FNB-80LI Battery Pack	9	Automatic Lamp Illumination on Scan Stop	54
Battery Charging	9	Band Edge Beeper	54
Installation of FBA-23 Battery Case	10	Weather Alert Scan	55
Low Battery Indication	10	Smart Search Operation	56
Interface of Packet TNCs	11	Channel Counter Operation	58
Operation	12	EPCS (Enhanced Paging & Code Squelch)	60
Switching Power On and Off	12	Storing the CTCSS Tone Pairs for EPCS Operation	60
Adjusting the Volume Level	12	Activating the Enhanced Paging & Code Squelch System	61
Squelch Adjustment	13	Paging Answer Back	61
Selecting the Operating Band	14	Emergency Feature	62
Frequency Navigation	14	Emergency Channel Operation	62
Transmission	16	Emergency Automatic ID (EAI) Feature	62
Changing the Transmit Power Level	17	Selecting the EAI mode and its Transmit Time	63
Changing the Microphone Gain Level	18	Activating the EAI feature	63
AM Broadcast Reception	18	To Locate an Unresponsive Operator Using the EAI Feature	64
AM Aircraft Reception	19	ARTS™ (Automatic Range Transponder System)	65
FM Broadcast/TV Audio Reception	19	Sensor Mode	68
Advanced Operation	20	To display the Temperature	68
Keyboard Locking	20	To display the Sensor Information	68
Adjusting the Keypad Beeper Volume Level	21	Selecting and Correcting the Atmospheric Pressure Meter	69
Keypad/LCD Illumination	21	Selecting and Correcting the Altimeter	69
Changing the Channel Steps	22	Internet Connection Feature	70
Changing the Receiving Mode	22	SRG (“Sister Radio Group”) Mode	70
RF Squelch	23	FRG (“Friendly Radio Group”) Mode	71
Checking the Battery Voltage	23	DTMF Operation	73
Repeater Operation	24	Manual DTMF Tone Generation	73
Repeater Shifts	24	DTMF Autodialer	73
Automatic Repeater Shift (ARS)	24	CW Training Feature	75
Manual Repeater Shift Activation	25	Miscellaneous Settings	76
CTCSS/DCS Operation	27	Password	76
CTCSS Operation	27	Programming the “P” Key	77
DCS Operation	28	Receive Battery Saver Setup	77
DCS Code Inversion	29	Wakeup Feature Setup	78
CTCSS/DCS Bell Operation	30	TX Battery Saver	79
Tone Search Scanning	31	ATT (Front End Attenuator)	79
Split Tone Operation	32	Disabling the TX/BUSY Indicator	80
Tone Calling (1750 Hz)	32	Automatic Power-Off (APO) Feature	80
Memory Mode	33	Automatic Power-On Feature	81
Memory Storage	34	Busy Channel Lock-Out (BCLO)	82
Storing Independent Transmit Frequencies (“Odd Split”)	34	Transmitter Time-Out Timer (TOT)	83
Memory Recall	35	Changing the TX Deviation Level	83
Labeling Memories	35	Reset Procedures	85
Memory Offset Tuning	37	Cloning	86
Moving Memory Data to the VFO	38	Set (Menu) Mode	87
Masking Memories	38	Specifications	104
Memory Only Mode	38	“AUTO” Mode Preset Operating Parameters	106
HOME Channel Memory	39		
Memory Bank Operation	40		
Direct Memory Recall Channel	42		
Short-Wave Broadcast Station Memory Channels	43		
Weather Broadcast Channels	44		
VHF-Marine Channels	45		

GENERAL DESCRIPTION

The **VX-6E** is a dual band heavy duty submersible* transceiver with extensive receive frequency coverage, providing local-area two-way amateur communications along with unmatched monitoring capability.

The **VX-6E**'s small size allows you to take it anywhere - hiking, skiing, or while walking around town - and its operating flexibility brings the user many avenues of operating enjoyment. Its incredibly compact **FNB-80LI** Rechargeable Lithium Ion Battery Pack provides up to 5 Watts of transmit power on 144 MHz and 430 MHz Amateur Bands. Besides 144- and 430-MHz transceive operation, the **VX-6E** provides receive coverage of the AM (MF) and FM broadcast bands, HF Shortwave Bands, VHF and UHF TV bands, the VHF AM aircraft band, and a wide range of commercial and public safety frequencies!

New and exciting features of the **VX-6E** are the Emergency Automatic ID (EAI) function, that will automatically cause your **VX-6E** to transmit your callsign and engage your rig's microphone, even if you are disabled and unable to press the **PTT** switch; Enhanced Paging and Code Squelch (EPCS), that allows you to page a particular station and only receive calls from that station, if desired; and a security Password feature, that will allow you to turn on and operate your transceiver only after you enter your Password.



Additional features include a convenient access key for Vertex Standard's **WIRES™** (Wide-coverage Internet Repeater Enhancement System), a transmit Time-Out Timer (TOT), Automatic Power-Off (APO), Automatic Repeater Shift (ARS), Yaesu's exclusive **ARTS™** (Auto-Range Transponder System) which "beeps" the user when you move out of communications range with another **ARTS™** equipped station, plus provision for reduction of the TX deviation in areas of high channel congestion. And an RF squelch circuit allows the owner to set the squelch to open at a programmable setting of the S-Meter, thus reducing guesswork in setting the squelch threshold.

We appreciate your purchase of the **VX-6E**, and encourage you to read this manual thoroughly, so as to learn about the many exciting features of your exciting new Yaesu hand-held transceiver!

※: IPX7 Specification for submersibility:
3 ft. for 30 minutes

Attention in case of use

This transceiver works on frequencies which are not generally permitted.

As for the actual usage, the user has to possess an amateur radio licence.

Usage is allowed only in the frequency bands which are allocated for amateur radios.

List of the practicable area

AUT	BEL	CYP	CZE	DNK
EST	FIN	FRA	DEU	GRC
HUN	ISL	IRL	ITA	LVA
LIE	LTU	LUX	MLT	NLD
NOR	POL	PRT	SVK	SVN
ESP	SWE	CHE	GBR	-

ACCESSORIES & OPTIONS

SUPPLIED ACCESSORIES

- FNB-80LI** 7.4 V, 1,400 mAh
Rechargeable Lithium Ion Battery Pack
 - NC-72C/U*** 5-Hour Battery Charger
 - CLIP-14** Quick Draw Belt Clip
 - YHA-67** Antenna
 - Operating Manual
 - Warranty Card
-

AVAILABLE OPTIONS

- FNB-80LI** 7.4 V, 1,400 mAh
Rechargeable Lithium Ion Battery Pack
- FBA-23** 2 x “AA” Cell Battery Case (batteries not supplied)
- CD-15A** Rapid Charger (requires **NC-72B/C/U**)
- NC-72B/C/U*** 5-Hour Battery Charger
- E-DC-5B** DC Cable with Cigarette-Lighter Adapter
- E-DC-6** DC Cable; plug and wire only
- MH-57A4B** Speaker/Microphone
- CMP460A** Waterproof Speaker/Microphone
- VC-24** VOX Headset
- VC-27** Ear piece/Microphone
- CT-91** Microphone Adapter
- CN-3** BNC-to-SMA Adapter
- SU-1** Barometric Pressure Sensor Unit
- CSC-91** Soft Case

*: “**B**” suffix is for use with 100-120 VAC, “**C**” suffix is for use with 230-240 VAC, and “**U**” suffix is for use with 230 VAC.

Availability of accessories may vary. Some accessories are supplied as standard per local requirements, while others may be unavailable in some regions. This product is designed to perform optimally when used with genuine Yaesu accessories. Vertex Standard shall not be liable for any damage to this product and/or accidents such as fire, leakage or explosion of a battery pack, etc., caused by the malfunction of non-Yaesu accessories. Consult your Yaesu dealer for details regarding these and any newly-available options. Connection of any non-Yaesu-approved accessory, should it cause damage, may void the Limited Warranty on this apparatus.

CONTROL & CONNECTIONS (TOP & FRONT PANEL)

① Antenna Jack

Connect the supplied rubber flex antenna (or another antenna presenting a 50-Ohm impedance) here.

② MIC/SP Jack

This four-conductor miniature jack provides connection points for microphone audio, earphone audio, PTT, and ground.



Do not allow the VX-6E to become submerged in water while the plastic cover over the MIC/SP jack is removed.

③ VOL Knob

This control adjusts the audio volume level. Clockwise rotation increases the volume level.

④ DIAL Knob

This (inner) 20-position detented rotary switch is used for setting the operating frequency, and also is used for menu selections and other adjustments.

⑤ LCD (Liquid Crystal Display)

The display shows current operating conditions, as indicated on the next page.

⑥ POWER Switch

Press and hold in this switch for one second to toggle the transceiver's power on and off.

⑦ Keypad

These 18 keys select many of most important operating features on the **VX-6E**. The functions of the keys are described in detail on the pages to follow.

⑧ Microphone

The internal microphone is located here.

⑨ Speaker

The internal speaker is located here.

⑩ TX/BUSY Indicator Lamp

This indicator glows green when the squelch opens, and turns red during transmit. During "Emergency Channel" operation (see page 62), this indicator will glow (or flash) white. Also, this indicator can be useful as a flashlight in a dark environment via Set Mode Item 34: **LED LT**; see page 96 for details.

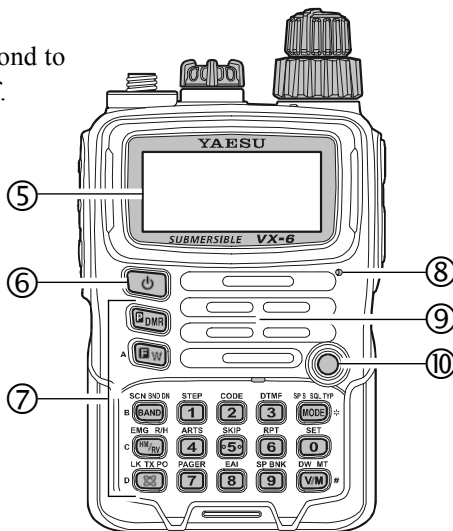
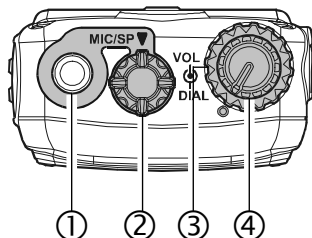

CONTROL & CONNECTIONS (LCD)

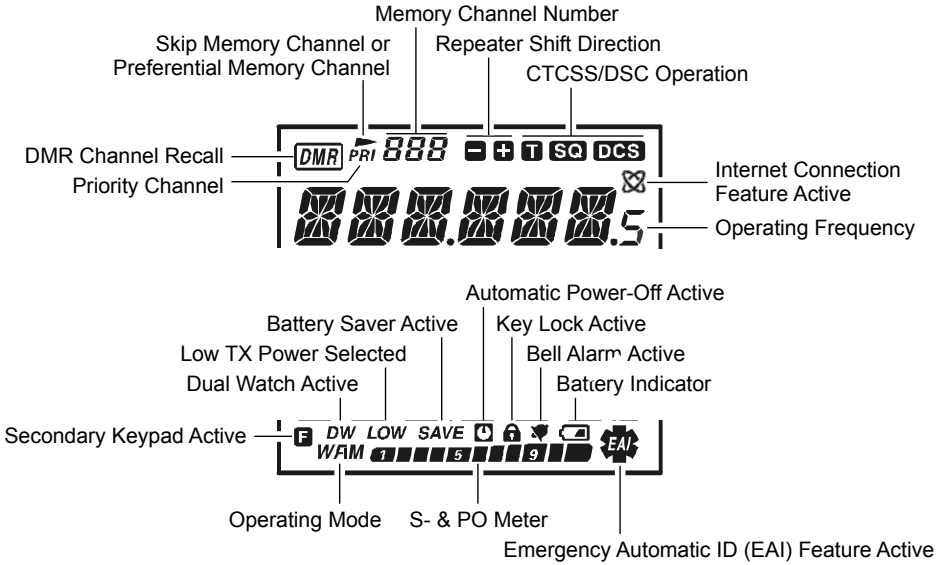

CONTROL & CONNECTIONS (SIDE & BOTTOM PANEL)

① **PTT (Push To Talk) Switch**
Press this switch to transmit, and release it (to receive) after your transmission is completed.

② **T-CALL Switch**
Pressing this switch activates the T-CALL (1750 Hz) for repeater access.

③ **EXT DC Jack**
This coaxial DC jack allows connection to an external DC power source (6-16V DC). The center pin of this jack is the Positive (+) connection.

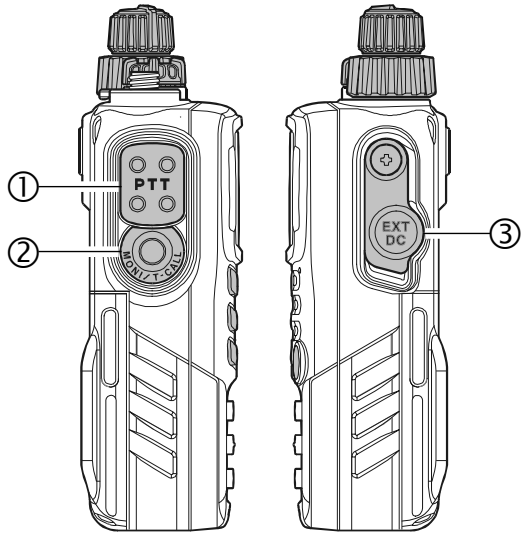





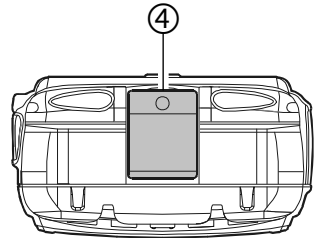



Do not allow the VX-6E to become submerged in water while the rubber cap over the EXT DC jack is removed.









④ **Battery Pack Latch**
Open this latch for battery removal.



CONTROL & CONNECTIONS (KEYPAD)

			
Primary Function (PRESS KEY)	Moves operation to the next-highest frequency band	Frequency entry digit "1"	Frequency entry digit "2"
Secondary Function (PRESS [F/W] + KEY)	Moves operation to the next-lowest frequency band	Selects the synthesizer steps to be used during VFO operation.	Selects the CTCSS tone or DCS code number
Third Function (PRESS & HOLD KEY)	Starts the scanner upward (toward a higher frequency or a higher channel number)	Stores the current setting into Direct Memory Recall Channel "1"	Stores the current setting into Direct Memory Recall Channel "2"
			
Primary Function (PRESS KEY)	Reverses the transmit and receive frequencies while working through a repeater	Frequency entry digit "4"	Frequency entry digit "5"
Secondary Function (PRESS [F/W] + KEY)	Activates the EMERGENCY function	Activates the ARTS™ feature	Selects the Memory Scan "Skip" channel-selection mode
Third Function (PRESS & HOLD KEY)	Switches to the "Home" (favorite frequency) Channel	Stores the current setting into Direct Memory Recall Channel "4"	Stores the current setting into Direct Memory Recall Channel "5"
			
Primary Function (PRESS KEY)	Activates the Internet Connection feature	Frequency entry digit "7"	Frequency entry digit "8"
Secondary Function (PRESS [F/W] + KEY)	Selects the desired transmit power output level	Activates the EPCS (Enhanced Paging & Code Squelch) feature	Activates the EAI™ (Emergency Automatic ID) feature
Third Function (PRESS & HOLD KEY)	Activates the Key Lockout feature	Stores the current setting into Direct Memory Recall Channel "7"	Stores the current setting into Direct Memory Recall Channel "8"

CONTROL & CONNECTIONS (KEYPAD)

			
Frequency entry digit "3"	Selects the Receive mode among AM, FM, and Wide FM	Primary Function (PRESS KEY)	Activates the "User Programmed" mode
Selects the DTMF mode	Activates CTCSS or DCS Operation	Secondary Function (PRESS [F/W] + KEY)	No Action
Stores the current setting into Direct Memory Recall Channel "3"	Engage the Special Search mode	Third Function (PRESS & HOLD KEY)	Activates the Direct Memory Recall Channel function
			
Frequency entry digit "6"	Frequency entry digit "0"	Primary Function (PRESS KEY)	Activates the "Secondary" key function
Selects the direction of the uplink frequency shift (either "-", "+," or "simplex") during repeater operation	Engages the Set (Menu) Mode	Secondary Function (PRESS [F/W] + KEY)	Disables the "Secondary" key function
Stores the current setting into Direct Memory Recall Channel "6"	Stores the current setting into Direct Memory Recall Channel "0"	Third Function (PRESS & HOLD KEY)	Activates the "Memory Write" mode (for memory channel storage)
			
Frequency entry digit "9"	Switches frequency control between the VFO and Memory Systems	Primary Function (PRESS KEY)	
Enter the Special Bank mode	Activates the "Memory Tune" mode while in the Memory Recall mode	Secondary Function (PRESS [F/W] + KEY)	
Stores the current setting into Direct Memory Recall Channel "9"	Activates the Priority (Dual Watch) function	Third Function (PRESS & HOLD KEY)	

INSTALLATION OF ACCESSORIES

ANTENNA INSTALLATION

The supplied antenna provides good results over the entire frequency range of the transceiver. However, for enhanced reception on certain non-Amateur frequencies, you may wish to connect an antenna designed specifically for that frequency range, as the supplied antenna is necessarily a compromise outside the Amateur bands, and cannot be expected to provide high performance at all frequencies.

To install the supplied antenna, hold the bottom end of the antenna, then screw it onto the mating connector on the transceiver until it is snug. Do not over-tighten by use of extreme force.

Notes:

- Never transmit without having an antenna connected.
- When installing the supplied antenna, never hold the *upper* part of the antenna while screwing it onto the mating connector on the transceiver.
- If using an external antenna for transmission, ensure that the SWR presented to the transceiver is 1.5:1 or lower, to avoid excessive feedline loss.

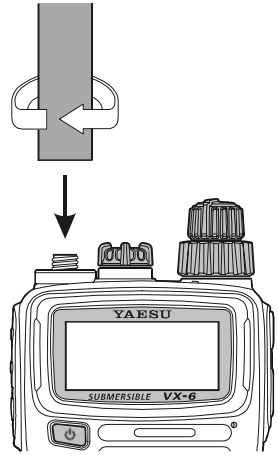

BELT CLIP & HAND STRAP INSTALLATION

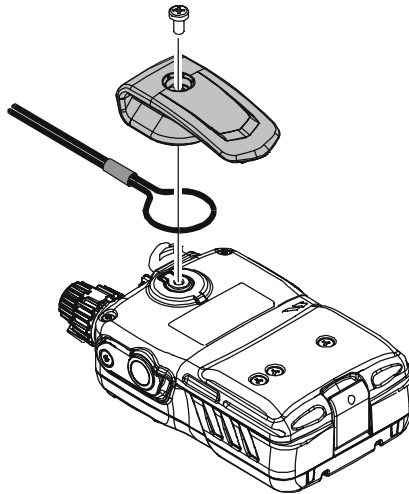

INSTALLATION OF ACCESSORIES

INSTALLATION OF FNB-80LI BATTERY PACK

The **FNB-80LI** is a high-performance Lithium-Ion battery providing high capacity in a very compact package. Under normal use, the **FNB-80LI** may be used for approximately 300 charge cycles, after which operating time may be expected to decrease. If you have an old battery pack which is displaying capacity which has become diminished, you should replace the pack with a new one.

- Install the **FNB-80LI** as shown in the illustration.
- Close the Battery Pack Latch on the bottom of the radio.

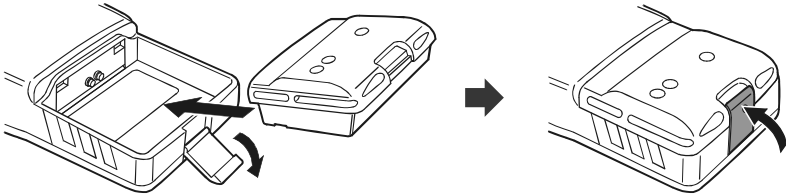

1) Do not attempt to open any of the rechargeable Li-Ion packs, as personal injury or damage to the Li-Ion pack could occur if a cell or cells become accidentally short-circuited.

2) Danger of explosion if battery is incorrectly replaced. Replace only with the same or equivalent type.

CAUTION

Danger of explosion if battery is incorrectly replaced. Replace only with the same or equivalent type.

BATTERY CHARGING

If the battery has never been used, or its charge is depleted, it may be charged by connecting the **NC-72** Battery Charger, as shown in the illustration, to the **EXT DC** jack. If only 12 ~ 16 Volt DC power is available, the optional **E-DC-5B** or **E-DC-6** DC Adapter (with its cigarette lighter plug) may also be used for charging the battery.

The display will indicate “**CHGNG**,” and the **TX/BUSY** indicator will glow red, while the battery is being charged. When charging is finished, the display will change to indicate “**CHGFUL**” and the **TX/BUSY** indicator will glow green.

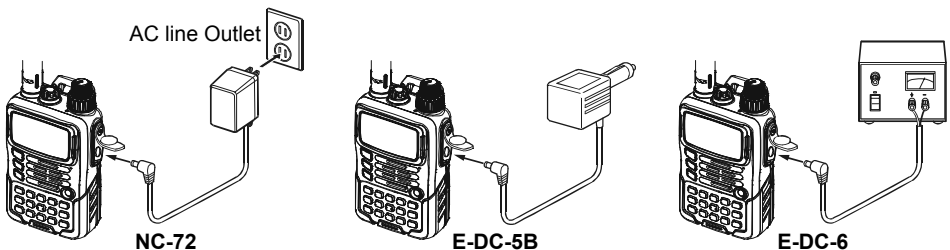

INSTALLATION OF ACCESSORIES

INSTALLATION OF FBA-23 ALKALINE BATTERY CASE (OPTION)

The optional **FBA-23** Battery Case allows receive monitoring using two “AA” size Alkaline batteries. Alkaline batteries can also be used for transmission in an emergency, but power output will only be selectable 300 mW and 50 mW, and battery life will be shortened dramatically.

To Install Alkaline Batteries into the **FBA-23**

- Slide the batteries into the **FBA-23** as shown in the illustration, with the Negative [-] side of the batteries touching the spring connections inside the **FBA-23**.
- Open the Battery Pack Latch on the bottom of the radio.
- Install the **FBA-23** as shown in the illustration, with the [+] side facing the bottom of the transceiver.
- Close the Battery Pack Latch on the bottom of the radio.

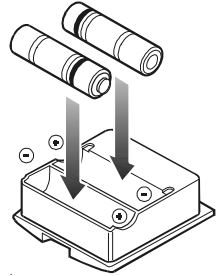



The **FBA-23** does not provide connections for charging, since Alkaline cells cannot be re-charged. Therefore, the **NC-72**, **E-DC-5B**, or **E-DC-6** may safely be connected to the **EXT DC** jack when the **FBA-23** is installed.



1) The FBA-23 is designed for use only with AA-type Alkaline cells.

2) If you do not use the VX-6E for a long time, remove the Alkaline batteries from the FBA-23, as battery leakage could cause damage to the FBA-23 and/or the transceiver.

LOW BATTERY INDICATION

- As your battery discharges during use, the voltage will gradually become lower. When the battery voltage is becoming too low for reliable operation, the “” icon will blink on the LCD display, indicating that the battery pack must be recharged before further use.
- Avoid recharging Lithium-Ion batteries before the “” indicator is observed, as this can degrade the charge capacity of your Lithium-Ion battery pack.

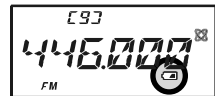

INTERFACE OF PACKET TNCs

The **VX-6E** may be used for Packet operation, using the optional **CT-91** microphone adapter (available from your Yaesu dealer) for easy interconnection to commonly-available connectors wired to your TNC. You may also build your own cable, using a four-conductor miniature phone plug, per the diagram below.

The audio level from the receiver to the TNC may be adjusted by using the **VOL** knob, as with voice operation. The input level to the **VX-6E** from the TNC may be adjusted via Set Mode Item 37: **MCGAIN**; see page 18 for details.

Be sure to turn the transceiver and TNC off before connecting the cables, so as to prevent voltage spikes from possibly damaging your transceiver.

When you are operating on Packet, switch the Receive Battery Saver OFF, as the “sleep” cycle may “collide” with the beginning of an incoming Packet transmission, causing your TNC not to receive the full data burst. See page 77 for details regarding Receive Battery Saver setup. Remember to readjust the default microphone input level to “**LVL 5**” (Set Mode Item 37: **MCGAIN**) when Packet operation is finished.

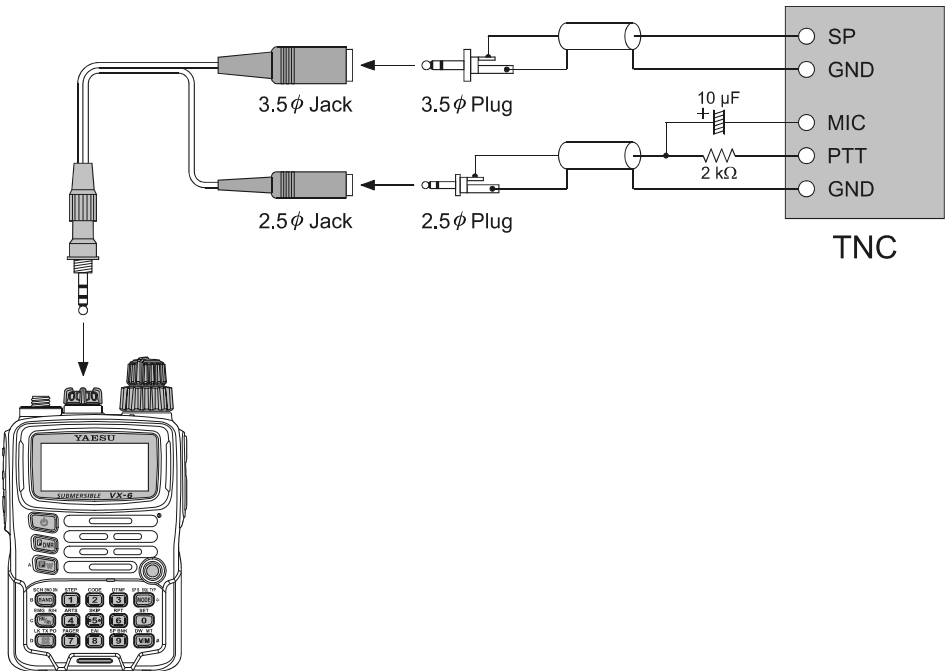

OPERATION



Hi! I'm R. F. Radio, and I'll be helping you along as you learn the many features of the VX-6E. I know you're anxious to get on the air, but I encourage you to read the "Operation" section of this manual as thoroughly as possible, so you'll get the most out of this fantastic new transceiver. Now. . .let's get operating!

SWITCHING POWER ON AND OFF

1. Be sure the Battery Pack is installed, and that the battery is fully charged. Connect the antenna to the top panel ANTENNA jack.
2. Press and hold in the orange **POWER** switch (on the left side of the front panel) for one second. Two beeps will be heard when the switch has been held long enough, and the current DC supply voltage will be indicated on the display for 2 seconds; if you are using the **FNB-80LI** Battery Pack, the small "Lit" notation at the top of the display confirms that the Lithium-Ion Battery Pack has been detected. After this 2-second interval, the display will resume its normal indication of the operating frequency.
3. To turn the **VX-6E** off, press and hold in the **POWER** switch again for one second.

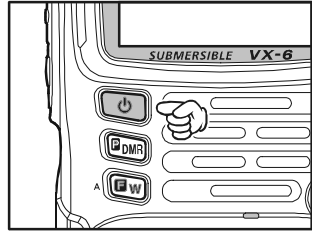

- 1) *If you don't hear the two "Beep" tones when the radio comes on, the Beeper may have been disabled via the Menu system. See page 21, which tells you how to reactivate the Beeper.*
- 2) *You can change the Opening Message (DC supply voltage indication) to any desired message (up to 6 characters) via Set Mode Item 42: OPN.MSG; see page 48 for details.*

ADJUSTING THE VOLUME LEVEL

Rotate the **VOLUME** control (inner knob) to set the desired audio level. Clockwise rotation increases the volume level.

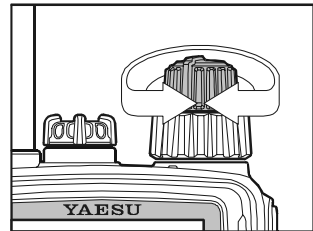

SQUELCH ADJUSTMENT

The **VX-6E**'s Squelch system allows you to mute the background noise when no signal is being received. Not only does the Squelch system make "standby" operation more pleasant, it also significantly reduces battery current consumption.

The Squelch system may be adjusted independently for the FM and Wide-FM (FM Broadcast) modes. AM utilizes the setting chosen for FM.

1. Press the **[F/W]** key, then press the **[0(SET)]** key to enter the Set mode.
2. Rotate the **DIAL** knob to select Set Mode Item 58: **SQL**.
3. Now, rotate the **DIAL** knob to set the Squelch so that the background noise is just silenced (typically at a setting of about "1" or "2" for FM and AM, and "2" or "3" for Wide-FM); this is point of maximum sensitivity to weak signals.
4. When you are satisfied with the Squelch threshold setting, press the **PTT** key momentarily to save the new setting and exit to normal operation.



- 1) A special "RF Squelch" feature is provided on the VX-6E. This feature allows you to set the squelch so that only signals exceeding a certain S-meter level will open the squelch. See page 23 for details.*
- 2) If you're operating in an area of high RF pollution, you may need to consider "Tone Squelch" operation using the built-in CTCSS Decoder. This feature will keep your radio quiet until a call is received from a station sending a carrier which contains a matching (subaudible) CTCSS tone. Or, if your friends have radios equipped with DCS (Digital Coded Squelch) like your VX-6E has, try using that mode for silent monitoring of busy channels.*

OPERATION

SELECTING THE OPERATING BAND

The **VX-6E** covers an incredibly wide frequency range, over which a number of different operating modes are used. Therefore, the **VX-6E**'s frequency coverage has been divided into different operating bands, each of which has its own pre-set channel steps and operating modes. You can change the channel steps and operating modes later, if you like (see page 22).

BAND [BAND NUMBER]	FREQUENCY RANGE
BC Band [1]	0.504 - 1.8 MHz
SW Band [2]	1.8 - 30 MHz
50 MHz Ham Band [3]	30 - 88 MHz
FM BC Band [4]	88 - 108 MHz
Air Band [5]	108 - 137 MHz
144 MHz Ham Band [6]	137 - 174 MHz
VHF-TV Band [7]	174 - 222 MHz
Action Band 1 [8]	222 - 420 MHz
430 MHz Ham Band [9]	420 - 470 MHz
UHF-TV Band [A]	470 - 800 MHz
Action Band 2 [b]	800 - 999 MHz

To Change Operating Bands:

1. Press the [**BAND(SCN)BND DN**] key repetitively. You will see the LCD indication move toward a higher frequency band each time you press the [**BAND(SCN)BND DN**] key.
2. If you wish to move the operating band selection downward (toward lower frequencies), press the [**F/W**] key first, then press the [**BAND(SCN)BND DN**] key.
3. Once you have selected the desired band, you may initiate manual tuning (or scanning) per the discussion in the next chapter.

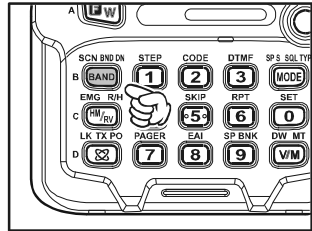

When receiving in the AM Broadcast or Shortwave bands (0.5-30 MHz), we recommend that you connect an external antenna, for improved reception.

FREQUENCY NAVIGATION

The **VX-6E** will initially be operating in the “VFO” mode, a channelized system which allows free tuning throughout the currently-selected operating band.

Three basic frequency navigation methods are available on the **VX-6E**:

1) Tuning Dial

Rotation of the **DIAL** allows tuning in the pre-programmed steps established for the current operating band. Clockwise rotation of the **DIAL** causes the **VX-6E** to be tuned toward a higher frequency, while counter-clockwise rotation will lower the operating frequency.

If you press the [**F/W**] key momentarily, then rotate the **DIAL**, frequency steps of 1 MHz will be selected. This feature is extremely useful for making rapid frequency excursions over the wide tuning range of the **VX-6E**.

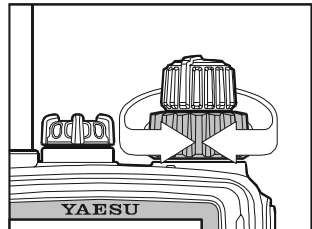

FREQUENCY NAVIGATION

2) Direct Keypad Frequency Entry

The desired operating frequency may be entered directly from the keypad.

To enter a frequency from the keypad, just press the numbered digits on the keypad in the proper sequence. There is no “Decimal point” key on the **VX-6E**, so if the frequency is below 100 MHz (e.g. 15.150 MHz), any required leading zeroes must be entered. However, there is a short-cut for frequencies ending in zero - press the [V/M(DW)MT] key after the last non-zero digit.

Examples: To enter 146.520 MHz, press [1] → [4] → [6] → [5] → [6] → [0]
 To enter 15.255 MHz, press [0] → [1] → [5] → [2] → [5] → [5]
 To enter 1.250 MHz (1250 kHz), press [0] → [0] → [1] → [2] → [5] → [0]
 To enter 0.950 MHz (950 kHz), press [0] → [0] → [0] → [9] → [5] → [0]
 To enter 430.000MHz, press [4] → [3] → [V/M(DW)MT]

3) Scanning

From the VFO mode, press and hold in the [BAND(SCN)BND DN] key for one second, and rotate the **DIAL** knob *while holding in the [BAND(SCN)BND DN] key*, to select the bandwidth for the VFO scanner, then release the [BAND(SCN)BND DN] key to begin scanning toward a higher frequency. The scanner will stop when it receives a signal strong enough to break through the Squelch threshold. The **VX-6E** will then hold on that frequency according to the setting of the “RESUME” mode (Set Mode Item 48: **RESUME**). See page 46 for details regarding Scan Operation.

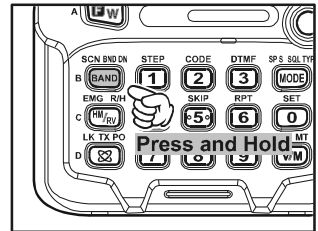

If you wish to reverse the direction of the scan (i.e. toward a lower frequency, instead of a higher frequency), just rotate the **DIAL** one click in the counter-clockwise direction while the **VX-6E** is scanning. The scanning direction will be reversed. To revert to scanning toward a higher frequency once more, rotate the **DIAL** one click clockwise.

Press the **PTT** switch momentarily to cancel the scanning. This only stops the scan; it does not cause transmission to occur.

Notice

The **VX-6E** may receive very strong signals on the Image frequency. If you experience interference that you suspect may be coming in via an “Image” path, you may calculate the possible frequencies using the formulas below. This information may be used in the design of effective countermeasures such as traps, etc.

$$\bigcirc 3.579545 \text{ MHz} \times n \quad \bigcirc 11.7 \text{ MHz} \times n \quad (n \text{ is an integer: } 1, 2, 3, \dots)$$

OPERATION

TRANSMISSION

Once you have set up an appropriate frequency inside one of the 144 MHz, or 430 MHz Amateur bands on which the **VX-6E** can transmit, you're ready to go on the air! These are the most basic steps; more advanced aspects of transmitter operation will be discussed later.

1. To transmit, press the **PTT** switch, and speak into the front panel microphone (located in the upper right-hand corner of the speaker grille) in a normal voice level. The **TX/BUSY** indicator will glow red during transmission.
2. To return to the receive mode, release the **PTT** switch.
3. During transmission, the relative power level will be indicated on the bar graph at the bottom of the LCD; full scale deflection confirms "**High Power**" operation, while deflection of three bars indicates "**Low 1 Power**" operation. Five bars indicates "**Low 2 Power**" operation and seven bars indicates "**Low 3 Power**" operation. Additionally, the "**LOW**" icon will appear at the bottom of the display while operating on the "**Low Power**" settings.

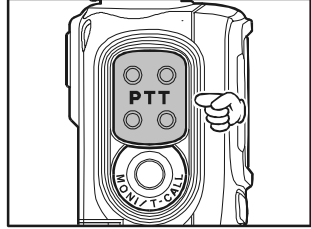

1) If you're just talking to friends in the immediate area, you'll get much longer battery life by switching to Low Power operation, described in the next chapter. And don't forget: always have an antenna connected when you transmit.

2) Transmission is possible only on the 144 MHz, and 430 MHz bands.

3) If other users report that you always have a DTMF "beep" at the beginning of each transmission, you may have accidentally switched on the "Internet Connection" feature. Just press the [ⓧ (LK)TXPO] key momentarily to disable this feature, which is described in detail on page 70.

TRANSMISSION

Changing the Transmitter Power Level

You can select between a total of four transmitter power levels on your **VX-6E**. The exact power output will vary somewhat, depending on the voltage supplied to the transceiver. With the standard **FNB-80LI** Battery Pack and external DC source, the power output levels available are:

HIGH	5.0 W
Low 3	2.5 W
Low 2	1.0 W
Low 1	0.3 W

To change the power level:

- The default setting for the power output is “High;” in this configuration, the LCD shows no indication of the power output level. Pressing the **[FW]** key, followed by the **[⊗(LK)TXPO]** key, will display the current power output level.
- Within one second of releasing the **[⊗(LK)TXPO]** key, press the **[⊗(LK)TXPO]** key repetitively; this will cause the power level “LOW1,” “LOW2,” or “LOW3” to appear.
- Press the **[FW]** key, followed by the **[⊗(LK)TXPO]** key (repeatedly, if necessary) to make the “HIGH” notation appear and restore High Power operation.

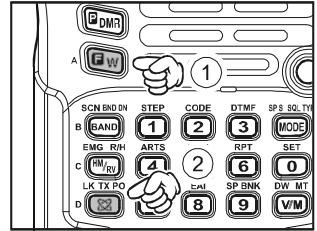

1) The VX-6E is smart! You can set up Low power on the 144 MHz band, while leaving 430 MHz on High power, and the radio will remember the different settings on both bands. And when you store memories, you can store the power output settings separately in each memory, so you don't waste battery power when using very close-in repeaters!

*2) When you are operating on the “Low” power settings, you can press the **[FW]** key, then press the PTT switch, to cause the VX-6E to transmit (temporarily) on High power. After one transmission, the power level will revert to the previously-selected setting.*

3) When the power supply voltage is 14-volt or above, reduce the transmit power to “Low 3” level automatically.

TRANSMISSION

Changing the Microphone Gain Level

Different operators speak at different voice levels, and speak at varying distances from the radio's microphone. So as to compensate for these differences, the **VX-6E** includes a Microphone Gain control, that allows you to set the Microphone Gain to the best level according to your operating preferences. Here's how to set the level:

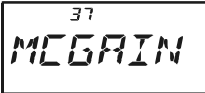
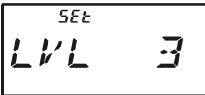
1. Press the [**F/W**] key, then press the [**0(SET)**] key to enter the Set mode.
2. Rotate the **DIAL** knob to select Set Mode Item 37: **MCGAIN**.
3. Press the [**0(SET)**] key momentarily to enable adjustment of this Set Mode Item. 
4. Rotate the **DIAL** knob to set the gain to a different level. The default setting is "**LVL 5**," if you wish to reduce the level, try a setting or "**LVL 3**" or "**LVL 4**" while transmitting and speaking into the microphone; you can hear the effects by monitoring on another radio tuned to your operating frequency. 
5. When you have made your selection, press and hold in the [**0(SET)**] key for 2 seconds to save the new setting and exit to normal operation

AM BROADCAST RECEPTION

The **VX-6E** includes provision for reception of AM broadcasts, either on the standard medium-wave (MW) broadcast band, or on the shortwave bands up to 30 MHz.

1. Press the [**BAND(SCN)BND DN**] key (or press the [**F/W**] key, followed by the [**BAND(SCN)BND DN**] key) repetitively until you see a frequency in the frequency range desired. The MW coverage is 0.5 MHz to 1.8 MHz, while the shortwave broadcast coverage is 1.8 MHz to 30 MHz. In either case, the operating mode (displayed on the bottom left of the LCD) should be shown as being "**AM**." 
2. Rotate the **DIAL** to tune across the broadcast band.
3. You may also use the keypad to enter frequencies directly. This method will be quicker for changing from the 49-meter broadcast band to the 31-meter band, for example.



1) *If the operating mode is not correct, you may change the operating mode by pressing the [**MODE(SP S)SQ TYP**] key.*

2) *The VX-6E includes a special memory bank into which the factory has stored 89 frequencies representing popular Short-wave Broadcast stations. See page 43 for details.*

AM AIRCRAFT RECEPTION

Reception of AM signals in the aeronautical band (108-137 MHz) is similar to that described in the previous section.

1. Press the [**BAND(SCN)BND DN**] key (or press the [**F/W**] key, followed by the [**BAND(SCN)BND DN**] key) (repetitively, if necessary), until you see a frequency in the aeronautical band.
2. Rotate the **DIAL** to tune across the aeronautical band.
3. You may also use the keypad to enter frequencies directly. Remember that frequencies quoted by aircraft operators may be abbreviated, and that the “5” at the end of a frequency may be dropped. Since aeronautical channels are assigned in 25-kHz steps, therefore, a frequency announced as “thirty-two, forty-two” corresponds to an operating frequency of 132.425 MHz.



FM BROADCAST/TV AUDIO RECEPTION

The **VX-6E** also includes provision for reception in the FM broadcast band, utilizing a wide-bandwidth filter which provides excellent fidelity.

To Activate FM Broadcast Reception

1. Press the [**BAND(SCN)BND DN**] key (or press the [**F/W**] key, followed by the [**BAND(SCN)BND DN**] key) repetitively until a frequency in the FM broadcast band appears on the display. The total frequency range included in the “FM” band is 88-108 MHz.
2. Rotate the **DIAL** to select the desired station. The default synthesizer steps for the W-FM mode are 100 kHz/step.

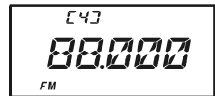

To Activate VHF or UHF TV Audio Reception

1. Press the [**BAND(SCN)BND DN**] key (or press the [**F/W**] key, followed by the [**BAND(SCN)BND DN**] key) repetitively until a frequency in the VHF or UHF TV bands appears on the LCD.
2. Rotate the **DIAL** to select the desired station.

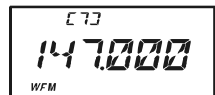

VHF TV Band

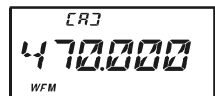

UHF TV Band



*Remember that the Wide-FM Squelch setting may be made independently from the Narrow-FM setting, adjust the Wide-FM Squelch setting by pressing the [**F/W**] key, followed by the **MONI** switch while in the Wide-FM mode.*

See page 13 for details.

ADVANCED OPERATION

Now that you've mastered the basics of **VX-6E** operation, let's learn more about some of the really neat features.

KEYBOARD LOCKING

In order to prevent accidental frequency change or inadvertent transmission, various aspects of the **VX-6E's DIAL** and keypad may be locked out. The possible lockout combinations are:

- KEY:** Just the front panel keypad is locked out
- DIAL:** Just the top panel **DIAL** is locked out
- K+D:** Both the keypad and **DIAL** are locked out (factory default)
- PTT:** The **PTT** switch is locked out (TX not possible)
- K+P:** Both the keypad and **PTT** switch are locked out
- D+P:** Both the **DIAL** and **PTT** switch are locked out
- ALL:** All of the above are locked out

To lock out some or all of the keys:

1. Press the [**F/W**] key, then press the [**0(SET)**] key to enter the Set mode.
2. Rotate the **DIAL** knob to select Set Mode Item 35: **LOCK**.
3. Press the [**0(SET)**] key momentarily to enable adjustment of this Item.
4. Rotate the **DIAL** knob to choose between one of the locking schemes as outlined above.
5. When you have made your selection, press the **PTT** switch to save the new setting and return to normal operation.

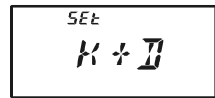
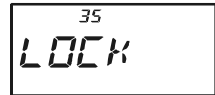

To activate the locking feature, *press and hold* in the [**LK TX PO**] key for 2 seconds. The “**🔒**” icon will appear on the LCD. To cancel locking, repeat this process.

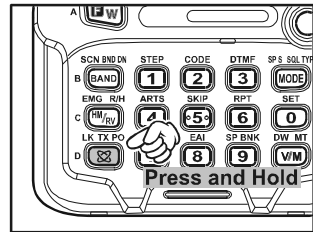
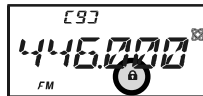

ADJUSTING THE KEYPAD BEEPER VOLUME LEVEL

A keypad beeper provides useful audible feed back whenever a keypad is pressed. The keypad beeper level changes according to the **VOL** knob setting. However, you may adjust the volume balance between the receiving audio and keypad beeper via the Set mode.

1. Press the **[F/W]** key, then press the **[0(SET)]** key to enter the Set mode.
2. Rotate the **DIAL** knob to select Set Mode Item 9: **BP LVL**.
3. Press the **[0(SET)]** key momentarily to enable adjustment of this Item.
4. Rotate the **DIAL** knob to select the desired level.
5. Press the **PTT** switch to save the new setting and return to normal operation.

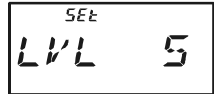
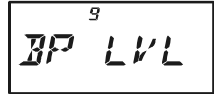

Additionally, if you want to turn the beep off:

1. Press the **[F/W]** key, then press the **[0(SET)]** key to enter the Set mode.
2. Rotate the **DIAL** knob to select Set Mode Item 7: **BEEP**.
3. Press the **[0(SET)]** key momentarily to enable adjustment of this Item.
4. Rotate the **DIAL** knob to change the setting to “OFF.”
5. Press the **PTT** switch to save the new setting and return to normal operation.
6. To turn the beep back on again, select “ON” in step 4 above.

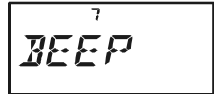

KEYPAD/LCD ILLUMINATION

Your **VX-6E** includes a reddish illumination lamp which aids in nighttime operation. The reddish illumination yields clear viewing of the display in a dark environment, with minimal degradation of your night vision.

Three options for activating the lamp are provided:

KEY Mode: Illuminates the Keypad/LCD for 5 seconds when any key pressed.

CONT Mode: Illuminates the Keypad/LCD continuously.

OFF Mode: Disables the Keypad/LCD lamp.

Here is the procedure for setting up the Lamp operating mode:

1. Press the **[F/W]** key, then press the **[0(SET)]** key to enter the Set mode.
2. Rotate the **DIAL** knob to select Set Mode Item 33: **LAMP**.
3. Press the **[0(SET)]** key momentarily to enable adjustment of this Item.
4. Rotate the **DIAL** knob to select one of the three modes described above.
5. When you have made your choice, press the **PTT** switch to save the new setting and return to normal operation.

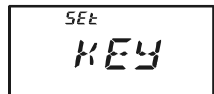
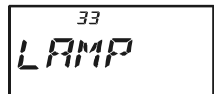

ADVANCED OPERATION

CHANGING THE CHANNEL STEPS

The **VX-6E**'s synthesizer provides the option of utilizing channel steps of 5/10/12.5/15/20/25/50/100 kHz per step, as well as an automatic step selection based on the current operating frequency ("AUTO"), any number of which may be important to your operating requirements. The **VX-6E** is set up at the factory in the "AUTO" configuration, which probably is satisfactory for most operation. However, if you need to change the channel step increments, the procedure to do so is very easy.

1. Press the [**F/W**] key, then press the [**1(STEP)**] key. This provides a "Short-cut" to Set Mode Item 61: **STEP**.
2. Rotate the **DIAL** to select the new channel step size.
3. Press the **PTT** key to save the new setting and exit to normal operation.



- 1) 9 kHz steps are available only when receiving on the BC band.
- 2) While operating on the BC band, you may only select channel steps of 9 kHz or 10 kHz; the other step selections are disabled.
- 3) 5 kHz and 15 kHz steps are not available for use on 250 - 300 MHz, nor above 580 MHz.

CHANGING THE RECEIVING MODE

The **VX-6E** provides for automatic receiving mode changing when the radio is tuned to different operating frequencies. However, should an unusual receiving situation arise in which you need to change other receiving mode, just press the [**MODE(SP S)SQ TYP**] key. The receiving modes available are:

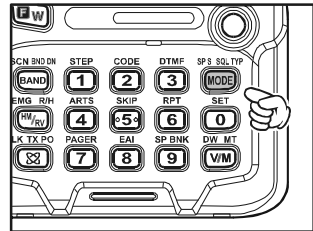

AUTO: Automatic mode setting per default values for the selected frequency range.

FM: Frequency Modulation for receiving an Amateur Radio Station and most VHF/UHF Communication.

WFM: Frequency Modulation for receiving an FM Broadcast Station.

AM: Amplitude Modulation for receiving a Short-wave Broadcast Station and Air Band Communication.



Unless you have a compelling reason to do so, leave the Automatic Mode Selection feature on so as to save time and trouble when changing bands. If you make a mode change for a particular channel or station, you can always store that one channel into memory, as the mode setting will be memorized along with the frequency information.

RF SQUELCH

A special RF Squelch feature is provided on this radio. This feature allows you to set the squelch so that only signals exceeding a certain S-meter level will open the squelch.

To set up the RF squelch circuit for operation, use the following procedure:

1. Press the **[F/W]** key, then press the **[0(SET)]** key to enter the Set mode.
2. Rotate the **DIAL** knob to select Set Mode Item 50: **RF SQL**.
3. Press the **[0(SET)]** key momentarily to enable adjustment of this Item.
4. Rotate the **DIAL** knob to select the desired signal strength level for the squelch threshold (**S1**, **S2**, **S3**, **S4**, **S5**, **S6**, **S7**, **S8**, **S9**, **S9+**, or **OFF**).
5. Press the **PTT** switch to save the new setting and return to normal operation.

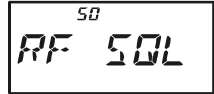

The display shows 'RF SQL' in large characters and 'S8' in smaller characters above it.

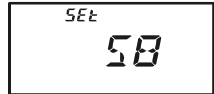

The display shows 'S8' in large characters and 'S8' in smaller characters above it.

CHECKING THE BATTERY VOLTAGE

The **VX-6E**'s microprocessor includes programming which will measure the current battery voltage.

1. Press the **[F/W]** key, then press the **[0(SET)]** key to enter the Set mode.
2. Rotate the **DIAL** knob to select Set Mode Item 16: **DC VLT**.
3. Press the **[0(SET)]** key momentarily to display the current DC voltage being supplied.
Lit: **FNB-80LI** is in use.
Edc: An external DC source is in use.
4. Press and hold in the **[0(SET)]** key for 2 seconds to return to normal operation.

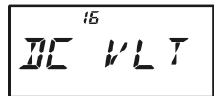

The display shows 'DC VLT' in large characters and '16' in smaller characters above it.

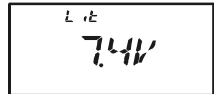

The display shows '7.4V' in large characters and 'L 16' in smaller characters above it.

REPEATER OPERATION

Repeater stations, usually located on mountaintops or other high locations, provide a dramatic extension of the communication range for low-powered hand-held or mobile transceivers. The **VX-6E** includes a number of features which make repeater operation simple and enjoyable.

REPEATER SHIFTS

Your **VX-6E** has been configured, at the factory, for the repeater shifts customary in your country. For the 144 MHz band shift will be 600 kHz; on the 430 MHz band, the shift may be 1.6 MHz, 7.6 MHz.

Depending on the part of the band in which you are operating, the repeater shift may be either downward (◻) or upward (⊕), and one of these icons will appear at the top of the LCD when repeater shifts have been enabled.



AUTOMATIC REPEATER SHIFT (ARS)

The **VX-6E** provides a convenient Automatic Repeater Shift feature, which causes the appropriate repeater shift to be applied automatically whenever you tune into the designated repeater sub-bands in your country. These sub-bands are shown below.

If the ARS feature does not appear to be working, you may have accidentally disabled it.

To re-enable ARS:

1. Press the [**F/W**] key, then press the [**0(SET)**] key to enter the Set mode.
2. Rotate the **DIAL** knob to select Set Mode Item 4: **ARS**.
3. Press the [**0(SET)**] key momentarily to enable adjustment of this Item.
4. Rotate the **DIAL** knob to select “**ON**.”
5. When you have made your selection, press the **PTT** switch to save the new setting and return to normal operation.

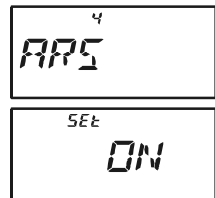

MANUAL REPEATER SHIFT ACTIVATION

If the ARS feature has been disabled, or if you need to set a repeater shift direction other than that established by the ARS, you may set the direction of the repeater shift manually.

To do this:

1. Press the [F/W] key, then press the [6(RPT)] key. This provides a “Short-cut” to Set Mode Item 51: **RPT**.
2. Rotate the **DIAL** knob to select the desired shift among “-RPT,” “+RPT,” and “SIMP.”
3. When you have made your selection, press the **PTT** switch to save the new setting and return to normal operation.

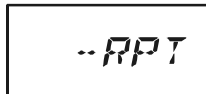

If you make a change in the shift direction, but still have Automatic Repeater Shift still engaged (see previous section), when you change frequency (by rotating the DIAL knob, for example) the ARS will over-ride your manual setting of the shift direction. Turn ARS off if you do not wish this to happen.

Changing the Default Repeater Shifts

If you travel to a different region, you may need to change the default repeater shift so as to ensure compatibility with local operating requirements.

To do this, follow the procedure below:

1. Set the **VX-6E**'s frequency to the band on which you wish to change the default repeater shift (144 MHz or 430 MHz Amateur Band).
2. Press the [F/W] key, then press the [0(SET)] key to enter the Set mode.
3. Rotate the **DIAL** knob to select Set Mode Item 56: **SHIFT**.
4. Press the [0(SET)] key momentarily to enable adjustment of this Item.
5. Rotate the **DIAL** knob to select the new repeater shift magnitude.
6. When you have made your selection, press the **PTT** switch to save the new setting and return to normal operation.

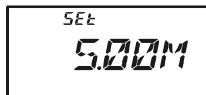
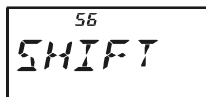

If you just have one “odd” split that you need to program, don’t change the “default” repeater shifts using this Set Mode Item. Enter the transmit and receive frequencies separately, as shown on page 34.

REPEATER OPERATION

MANUAL REPEATER SHIFT ACTIVATION

Checking the Repeater Uplink (Input) Frequency

It often is helpful to be able to check the uplink (input) frequency of a repeater, to see if the calling station is within direct (“Simplex”) range.

To do this, just press the [HM/RV(EMG)R/H] key. You’ll notice that the display has shifted to the repeater uplink frequency. Press the [HM/RV(EMG)R/H] key again to cause operation to revert to normal monitoring of the repeater downlink (output) frequency. While you are listening on the input frequency to the repeater using the [HM/RV(EMG)R/H] key, the repeater offset icon will blink.

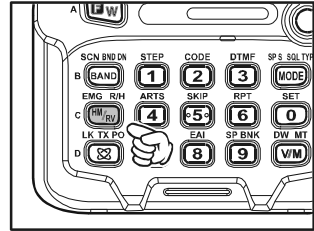

The configuration of this key may be set either to “RV” (for checking the input frequency of a repeater), or “HM” (for instant switching to the “Home” channel for the band you are operating on). To change the configuration of this key, use Set Mode Item 28: HM/RV. See page 45.

CTCSS OPERATION

Many repeater systems require that a very-low-frequency audio tone be superimposed on your FM carrier in order to activate the repeater. This helps prevent false activation of the repeater by radar or spurious signals from other transmitters. This tone system, called “CTCSS” (Continuous Tone Coded Squelch System), is included in your **VX-6E**, and is very easy to activate.



CTCSS setup involves two actions: setting the Tone Mode and then setting of the Tone Frequency. These actions are set up by using the [MODE(SP S) SQ TYP] key and [2(CODE)] key.

1. Press the **[F/W]** key, then press the **[MODE(SP S)SQ TYP]** key to enable selection of the CTCSS/DCS mode.
2. Rotate the **DIAL** knob so that the “**TONE**” indication appears on the display; this activates the CTCSS Encoder, for access to repeaters requiring a CTCSS tone.
3. Rotation of the **DIAL** knob one more “click” in step “2” above will cause the “**T SQL**” notation to appear. When “**T SQL**” is displayed, this means that the Tone Squelch system is active, which *mutes* your **VX-6E**’s receiver until it receives a call from another radio sending out a matching CTCSS tone. This can help keep your radio quiet until a specific call is received, which may be helpful while operating in congested areas of the band.



*1) You may notice a “**RV TN**” indication on the display while you rotate the **DIAL** knob in this step; this means that the Reverse Tone Squelch system is active, which mutes your **VX-6E**’s receiver (instead of opening the squelch) when it receives a call from the radio sending a matched CTCSS tone. The “**T SQL**” icon will blink on the display when the Reverse Tone Squelch system is activated.*

*2) You may notice a “**DCS**” indication on the display while you rotate the **DIAL** knob still more. We’ll discuss the Digital Code Squelch system shortly.*

4. When you have made your selection of the CTCSS tone mode, press the **PTT** switch to save the new setting.
5. Press the **[F/W]** key, then press the **[2(CODE)]** key to enable adjustment of the CTCSS frequency.
6. Rotate the **DIAL** knob until the display indicates the Tone Frequency you need to be using (ask the repeater owner/operator if you don’t know the tone frequency).

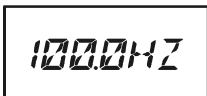

CTCSS TONE FREQUENCY (Hz)					
67.0	69.3	71.9	74.4	77.0	79.7
82.5	85.4	88.5	91.5	94.8	97.4
100.0	103.5	107.2	110.9	114.8	118.8
123.0	127.3	131.8	136.5	141.3	146.2
151.4	156.7	159.8	162.2	165.5	167.9
171.3	173.8	177.3	179.9	183.5	186.2
189.9	192.8	196.6	199.5	203.5	206.5
210.7	218.1	225.7	229.1	233.6	241.8
250.3	254.1	–	–	–	–

CTCSS/DCS OPERATION

CTCSS OPERATION

- When you have made your selection, press the [2(CODE)] key momentarily to save the new settings and exit to normal operation. This is different than the usual method of restoring normal operation, and it applies only to the configuration of the CTCSS/DCS frequencies.

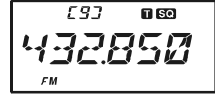

Your repeater may or may not re-transmit a CTCSS tone - some systems just use CTCSS to control access to the repeater, but don't pass it along when transmitting. If the S-Meter deflects, but the VX-6E is not passing audio, repeat steps "1" through "4" above, but rotate the DIAL so that "TONE" appears - this will allow you to hear all traffic on the channel being utilized.

DCS OPERATION

Another form of tone access control is Digital Code Squelch, or DCS. It is a newer, more advanced tone system which generally provides more immunity from false paging than does CTCSS. The DCS Encoder/Decoder is built into your **VX-6E**, and operation is very similar to that just described for CTCSS. Your repeater system may be configured for DCS; if not, DCS is frequently quite useful in Simplex operation if your friend(s) use transceivers equipped with this advanced feature.

Just as in CTCSS operation, DCS requires that you set the Tone Mode to DCS and that you select a tone code.

- Press the [F/W] key, then press the [MODE(SP S)SQ TYP] key to enable selection of the CTCSS/DCS mode.
- Rotate the **DIAL** knob until the "DCS" indication appears on the display; this activates the DCS Encoder/Decoder.
- Press the **PTT** key to save the new setting.
- Press the [F/W] key, then press the [2(CODE)] key to enable adjustment of the DCS code.
- Rotate the **DIAL** knob to select the desired DCS Code (a three-digit number). Ask the repeater owner/operator if you don't know DCS Code; if you are working simplex, just set up the DCS Code to be the same as that used by your friend(s).
- When you have made your selection, press the [2(CODE)] key momentarily to save the new settings and exit to normal operation.



DCS CODE										
023	025	026	031	032	036	043	047	051	053	
054	065	071	072	073	074	114	115	116	122	
125	131	132	134	143	145	152	155	156	162	
165	172	174	205	212	223	225	226	243	244	
245	246	251	252	255	261	263	265	266	271	
274	306	311	315	325	331	332	343	346	351	
356	364	365	371	411	412	413	423	431	432	
445	446	452	454	455	462	464	465	466	503	
506	516	523	526	532	546	565	606	612	624	
627	631	632	654	662	664	703	712	723	731	
732	734	743	754	-	-	-	-	-	-	

DCS OPERATION



Remember that the DCS is an Encode/Decode system, so your receiver will remain muted until a matching DCS code is received on an incoming transmission. Switch the DCS off when you're just tuning around the band!

DCS CODE INVERSION

The DCS system was first introduced in the commercial LMR (Land Mobile Radio) service, where it is now in widespread use. DCS is sometime referred to by its different proprietary names, such as DPL® (Digital Private Line®, a registered trademark of Motorola, Inc.).

DCS uses a codeword consisting of a 23-bit frame, transmitted (subaudible) at a data rate of 134.4 bps (bit/sec). Occasionally, signal inversion can result in the complement of a code to be sent or received. This prevents the receiver's squelch from opening with DCS enabled, as the decoded bit sequence would not match that selected for operation.

Typical situations that might cause inversion to occur are:

- Connection of an external receiver preamplifier.
- Operating through a repeater.
- Connection of an external linear amplifier.

Note that code inversion does not mean that any of the above listed equipment is defective!

In certain amplifier configurations, the output signal (phase) is inverted from the input. Small signal or power amplifiers having an odd number (1, 3, 5, etc.) of amplification stages may result in inversion of a transmitted or received DCS code.

While under most circumstances this should not occur (amplifier designs and industry standards take this into account), if you find that your receiver squelch does not open when both you and the other station are using a common DCS code, you or the other station (but not both) can try the following:

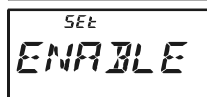
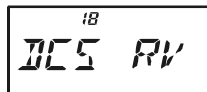

1. Press the **[F/W]** key, then press the **[0(SET)]** key to enter the Set mode.
2. Rotate the **DIAL** knob to select Set Mode Item 18: **DCS RV**.
3. Press the **[0(SET)]** key momentarily, then rotate the **DIAL** knob to set this Set Mode Item to "ENABLE" (thus inverting the DCS Code).
4. When you have made your selection, press the **PTT** switch to save the new setting and exit to normal operation.
5. Remember to restore the default setting to "DISABLE" when done.



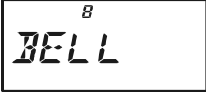

CTCSS/DCS OPERATION

CTCSS/DCS BELL OPERATION

During CTCSS Decode or DCS operation, you may set up the **VX-6E** such that a ringing “bell” sound alerts you to the fact that a call is coming in. Here is the procedure for activating the CTCSS/DCS Bell:

1. Set the transceiver up for CTCSS Decode (“Tone Squelch”) or DCS operation, as described previously.
2. Adjust the operating frequency to the desired channel.
3. Press the **[F/W]** key, then press the **[0(SET)]** key to enter the Set mode.
4. Rotate the **DIAL** knob to select Set Mode Item 8: **BELL**.
5. Press the **[0(SET)]** key momentarily to enable adjustment of this Set Mode Item. 
6. Rotate the **DIAL** knob to set the desired number of rings of the Bell. The available choices are “**1**,” “**3**,” “**5**,” or “**8**” rings, “**CONT**” (continuous ringing), or “**OFF**.” 
7. Press the **PTT** switch momentarily to save the new setting and exit to normal operation.



When you are called by a station whose transceiver is sending a CTCSS tone or DCS code which matches that set into your Decoder, the Bell will ring in accordance with this programming. When the CTCSS/DCS Bell is activated, the “” icon will appear at the upper right corner on the LCD. 

TONE SEARCH SCANNING

In operating situations where you don't know the CTCSS or DCS tone being used by another station or stations, you can command the radio to listen to the incoming signal and scan in search of the tone being used. Two things must be remembered in this regard:

- You must be sure that your repeater uses the same tone type (CTCSS vs. DCS).
- Some repeaters do not pass the CTCSS tone; you may have to listen to the station(s) transmitting on the repeater uplink (input) frequency in order to allow Tone Search Scanning to work.

To scan for the tone in use:

1. Set the radio up for either CTCSS or DCS Decoder operation (see the previous discussions). In the case of CTCSS, “**T SQ**” will appear on the display; in the case of DCS, “**DCS**” will appear on the display.
2. Press the [**F/W**] key, then press the [**2(CODE)**] key.
3. Press and hold in the [**BAND(SCN)BND DN**] key for one second to start scanning for the incoming CTCSS or DCS tone/code. 
4. When the radio detects the correct tone or code, it will halt on that tone/code, and audio will be allowed to pass. Press the [**BAND(SCN)BND DN**] key to lock in that tone/code, then press the [**F/W**] key to exit to normal operation. 



If the Tone Scan feature does not detect a tone or code, it will continue to scan indefinitely. When this happens, it may be that the other station is not sending any tone. You can press the PTT switch to halt the scan at any time.

You may listen to the (muted) signal from the other station during Tone Scanning when Set Mode Item 68: **TS MUT** is set to “**OFF**.” See page 102 for details. You can also change the Tone Search scanning speed, using Set Mode Item 69: **TS SPD**.” See page 102.

Tone Scanning works either in the VFO or Memory modes.

CTCSS/DCS OPERATION

SPLIT TONE OPERATION

The **VX-6E** can be operated in a Split Tone configuration via the Set mode.

1. Press the **[F/W]** key, then press the **[0(SET)]** key to enter the Set mode.
2. Rotate the **DIAL** knob to select Set Mode Item 58: **SPLIT**.
3. Press the **[0(SET)]** key momentarily to enable adjustment of this Set Mode Item.
4. Rotate the **DIAL** knob to select **ON** (to enable the Split Tone feature).
5. Press the **PTT** key momentarily to save the new setting and exit to normal operation.

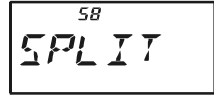

58
SPLIT



58
ON

When the Split Tone feature is activated, you can see the following additional parameters following the “**RV TN**” parameter (while selecting the tone mode by pressing **[F/W]** → **[MODE(SP S)SQ TYP]**):

D CODE: DCS Encode only (the “**DCS**” icon will blink during operation)

T DCS: Encodes a CTCSS Tone and Decodes a DCS code
(the “**T**” icon will blink and the “**DCS**” icon will appear during operation)

D TONE: Encodes a DCS code and Decodes a CTCSS Tone
(the “**T SQ**” icon will appear and the “**DCS**” icon will blink during operation)

Select the desired operating mode, from the selections shown above.

TONE CALLING (1750 Hz)

If the repeaters in your country require a 1750-Hz burst tone for access (typically in Europe), you can set the **MONI** switch to serve as a “Tone Call” switch instead. To change the configuration of this switch, we again use the Set Mode to help us.

1. Press the **[F/W]** key, then press the **[0(SET)]** key to enter the Set mode.
2. Rotate the **DIAL** knob to select Set Mode Item 36: **M/T-CL**.
3. Press the **[0(SET)]** key momentarily to enable adjustment of this Set Mode Item.
4. Rotate the **DIAL** knob to select “**T-CALL**” on the display.
5. Press the **PTT** switch to save the new setting and exit to normal operation.

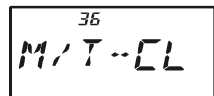

36
M/T-CL

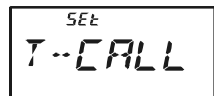

58
T-CALL

To access a repeater, press and hold in the **MONI** switch for the amount of time specified by the repeater owner/operator. The transmitter will automatically be activated, and a 1750-Hz audio tone will be superimposed on the carrier. Once access to the repeater has been gained, you may release the **MONI** switch, and use the **PTT** switch for activating the transmitter thereafter.

MEMORY MODE

The **VX-6E** provides a wide variety of memory system resources. These include:

- ❑ Regular Memory Channels, which made up of:
 - 900 “Standard” memory channels, numbered “1” through “900.”
 - 99 “Frequency Skip Memory” channels, numbered “901” through “999.”
 - 11 “Home” channels, providing storage and quick recall of one prime frequency on each operating band.
 - 50 sets of band-edge memories, also known as “Programmable Memory Scan” channels, labeled “L1/U1” through “L50/U50.”
 - 24 Memory Banks, labeled “BANK 1” through “BANK24.” Each Memory Bank can be assigned up to 100 channels from the “standard” and “PMS” memory channels.
- ❑ Special Memory Channels, which include:
 - A “Emergency Automatic ID (EAI)” Channel.
 - 10 “Direct Memory Recall” Channels.
 - 10 “Weather Broadcast” Channels.
 - 89 Popular Short-wave Broadcast Station Memory Channels.
 - 281 VHF Marine Channels.

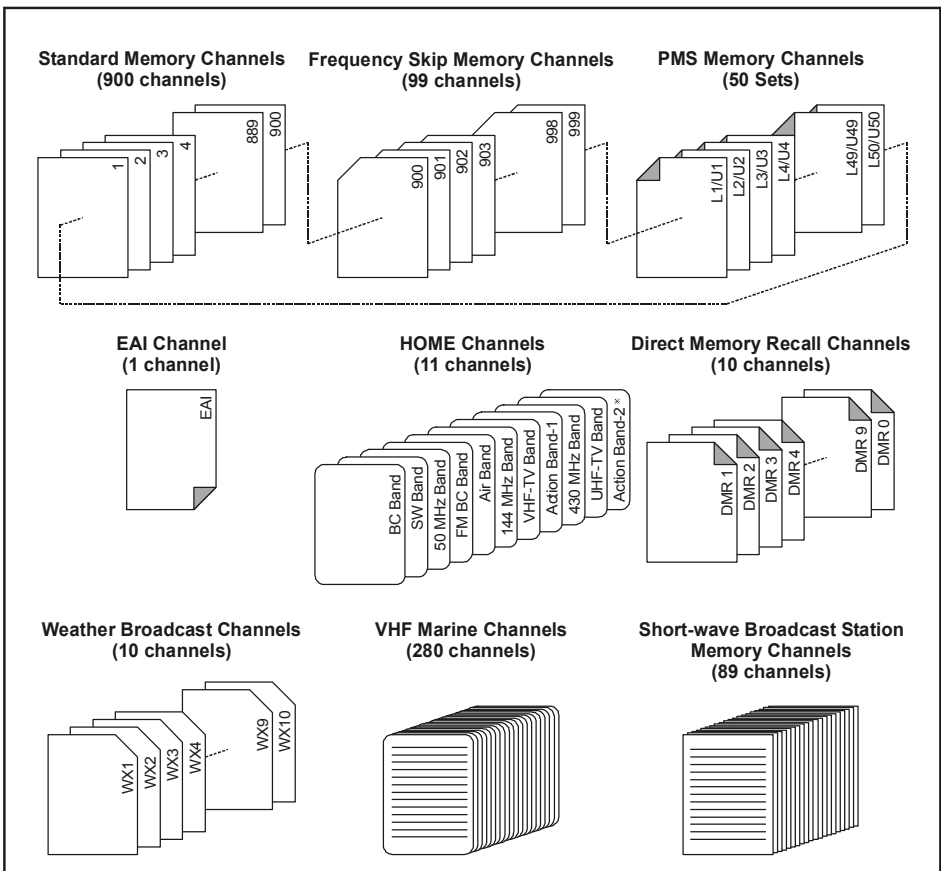

MEMORY STORAGE

1. Select the desired frequency, while operating in the VFO mode. Be **sure** to set up any desired CTCSS or DCS tones, as well as any desired repeater offset. The power level may also be set at this time, if you wish to store it.
2. Press and hold in the **[F/W]** key for one second.
3. Within five seconds of releasing the **[F/W]** key, you need to make a decision regarding channel storage. The microprocessor will automatically select the next-available “free” channel (a memory register on which no data has been stored), so you may not wish to make any change; if this is the case, proceed to step 4.
If you wish to select a different channel number into which to store the data, rotate the **DIAL** knob to select the desired memory channel. If you see a blinking memory channel number, it means that the channel currently has no data written on it (i.e. the channel is “free”).
4. Press the **[F/W]** key once more to store the frequency into memory.
5. You still will be operating in the “VFO” mode, so you may now enter other frequencies, and store them into additional memory locations, by repeating the above process.



1) You may change the automatic memory channel selection feature to select the “next-highest memory channel above the last-stored memory channel” by instead of the “next-available ‘free’ channel” via the Set Mode Item 38: MW MD; see page 97.

*2) In step 4 above, you may jump 100 memory channels, if you’re in a hurry (101 → 201 → 301 ...) by pressing the **[P(DMR)]** key (multiple times, if necessary). Similarly, if you wish to store to the designated memory channel, an easy way to designated memory is to key in the memory channel number, then press the **[V/M(DW)MT]** key. For example, to designate memory channel #14, press **[1] → [4] → [V/M(DW)MT]**. You may also designate the Memory Channel #000 and Programmable Memory channels (“L1/U1” through “L50/U50”) using the following numbers: Memory Channel #000 = “1000,” Programmable Memory channels #L1 = “1001,” U1 = “1002,” L50 = “1099,” and U50 = “1100.” In this case, you does not need pressing the **[V/M(DW)MT]** key.*

Storing Independent Transmit Frequencies (“Odd Splits”)

All memories can store an independent transmit frequency, for operation on repeaters with non-standard shift. To do this:

1. Store the receive frequency (downlink) using the method already described under **MEMORY STORAGE** (it doesn’t matter if a repeater offset is active).
2. Turn to the desired transmit (uplink) frequency, then press and hold in the **[F/W]** key for one second.
3. Within five seconds of releasing the **[F/W]** key, rotate the **DIAL** knob to select the same memory channel number as used in step “1” above.

MEMORY MODE (REGULAR MEMORY CHANNEL)

MEMORY STORAGE

- Press and hold in the **PTT** switch, then press the **[F/W]** key once more momentarily while holding the **PTT** switch in (this does not key the transmitter).



*Whenever you recall a memory which contains independently-stored transmit and receive frequencies, the “**FM**” indication will appear in the display.*

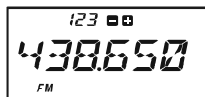

MEMORY RECALL

- While operating in the VFO mode, press the **[VM(DW)MT]** key to enter the Memory mode.
- Rotate the **DIAL** knob to select the desired channel.
- To return to the VFO mode, press the **[VM(DW)MT]** key.

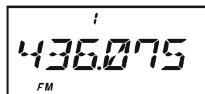

When the radio is already set to the Memory mode, an easy way to recall memories is to key in the memory channel number, then press the **[VM(DW)MT]** key.

For example, to recall memory channel #14, press **[1] → [4] → [VM(DW)MT]**.

You may also recall Memory Channel #000 and Programmable Memory channels (“L01/U01” through “L50/U50”) using the following numbers: Memory Channel #000 = “1000,” Programmable Memory channels #L1 = “1001,” U1 = “1002,” L50 = “1099,” and U50 = “1100.” In these case, you do not need to press the **[VM(DW)MT]** key.

LABELING MEMORIES

You may wish to append an alpha-numeric “Tag” (label) to a memory or memories, to aid in recollection of the channel’s use (such as a club name, etc.). This is easily accomplished using the Set Mode.

- Recall the memory channel on which you wish to append a label.
- Press the **[F/W]** key, then press the **[0(SET)]** key to enter the Set mode.
- Rotate the **DIAL** knob to select Set Mode Item 40: **NM SET**.
- Press the **[0(SET)]** key momentarily to enable programming of the name tag.
- Rotate the **DIAL** knob to select the first digit of the desired label.
- Press the **[MODE(SP S)SQ TYP]** key to move to the next character.
- If you make a mistake, press the **[BAND(SCN)BND DN]** key to back-space the cursor, then re-enter the correct letter, number, or symbol.
- Repeat steps 5 through 7 to program the remaining letters, numbers, or symbols of the

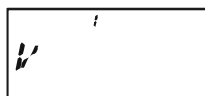
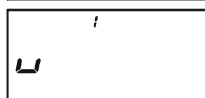
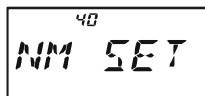
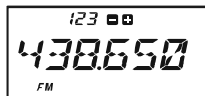

MEMORY MODE (REGULAR MEMORY CHANNEL)

LABELING MEMORIES

desired label. A total of six characters may be used in the creation of a label.

- When you have programmed a label which is under 6 characters, press the **[0(SET)]** key to confirm the label.
- When you have completed the creation of the label, press the **PTT** key to save the label and exit.

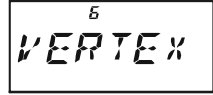

To display the alpha-numeric “Tag” (label):

- Set the **VX-6E** to the “MR” (Memory Recall) mode, and recall the memory channel on which you wish to display its label.
- Press the **[F/W]** key, then press the **[0(SET)]** key to enter the Set mode.
- Rotate the **DIAL** knob to select the Set Mode Item labeled 39: **NAME**.
- Press the **[0(SET)]** key momentarily to enable adjustment of this Item’s setting.
- Rotate the **DIAL** knob to set this Set Mode Item to “**ALPHA**” (thus enabling the alpha-numeric display).
- Press the **PTT** key to save the new setting and activate the alpha-numeric Tag.

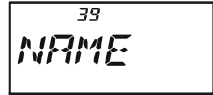

To disable the alpha-numeric Tag (enabling the frequency display), just repeat the above procedure, rotating the **DIAL** knob to select “**FREQ**” in step 5 above.



- 1) While programming multiple memories with alpha-numeric “Tags” with repetitive information, you may press the **[F/W]** key to copy a previous entry of letters and numbers, and then paste these characters into another “**NM SET**” register (on a different memory channel) by pressing the **[V/M(DW)MT]** key.*
- 2) You may check the frequency of any Name-tagged channel by pressing the **MONI** switch. Release the **MONI** switch, and the display returns to the alpha-numeric “Tag” display.*

MEMORY MODE (REGULAR MEMORY CHANNEL)

MEMORY OFFSET TUNING

Once you have recalled a particular memory channel, you may easily tune off that channel, as though you were in the “VFO” mode.

1. With the **VX-6E** in the “MR” (Memory Recall) mode, select the desired memory channel.
2. Press the **[F/W]** key, then press the **[V/M(DW)MT]** key to activate the “Memory Tuning” feature. The Memory Channel number will be replaced by “**tun.**” And if you have an alpha-numeric Tag displayed on the memory channel, the display will automatically revert to display of the operating frequency, so you can navigate without having to enter the Menu to change the display configuration.
3. Rotate the **DIAL** knob, as desired, to tune to a new frequency. The synthesizer steps selected for VFO operation on the current band will be the steps used during Memory Tuning.
4. If you wish to return to the original memory frequency, just press the **[V/M(DW)MT]** key momentarily. The display will revert to display of the alpha-numeric Tag (if any) that may have originally appeared on the LCD.
5. If you wish to store a new frequency set during Memory Tuning, just press and hold in the **[F/W]** key for one second, per normal memory storage procedure. The micro-processor will automatically set itself to the next-available clear memory location, and you then press **[F/W]** again to lock in the new frequency.



- 1) *If you want to replace the original memory contents with those of the new frequency, be sure to rotate the DIAL knob to the original memory channel number!*
- 2) *Any required CTCSS/DCS changes, or repeater offset modifications, must be done before storing the data into the new (or original) memory channel location.*

MEMORY MODE (REGULAR MEMORY CHANNEL)

MOVING MEMORY DATA TO THE VFO

Data stored on memory channels can easily be moved to the VFO, if you like.

1. Select the memory channel containing the frequency data to be moved to the VFO.
2. Press the **[F/W]** key, then press the **[V/M(DW)MT]** key to activate the “Memory Tune” feature temporarily, then press the **[F/W]** key, followed by the **[⊗(LK)TXPO]** key. The data will now have been copied to the VFO, although the original memory contents will remain intact on the previously-stored channel.

If a Split Frequency Memory channel was transferred, the TX frequency will be ignored (you will be set up for Simplex operation on the Receive frequency).

MASKING MEMORIES

There may be situations where you want to “Mask” memories so they are not visible during memory selection or scanning. For example, several memories used only in a city you visit infrequently may be stored, then “Masked” until you visit that city, at which time you can “Unmask” them for normal use.

1. Press the **[V/M(DW)MT]** key, if needed, to enter the MR mode.
2. Press and hold in the **[F/W]** key for one second, then rotate the **DIAL** knob to select the memory channel to be “Masked.”
3. Press the **[⊗(LK)TXPO]** key momentarily. The display will revert to memory channel #1. The previously-selected memory will be Masked.
4. To Unmask the hidden memory, repeat the above procedure: press and hold in the **[F/W]** key for one second, rotate the **DIAL** to select the masked memory’s number, then press the **[⊗(LK)TXPO]** key to restore the memory channel’s data.



Watch out! You can manually store data over a “Masked” memory, deleting previous data, if you’re not careful. Use the “next available memory” technique (look for the blinking memory channel number) storage technique to avoid over-writing a masked memory.

MEMORY ONLY MODE

Once memory channel programming has been completed, you may place the radio in a “Memory Only” mode, whereby VFO operation is impossible. This may be particularly useful during public-service events, where a number of operators may be using the radio for first time, and ultimate simplicity of channel selection is desired.

To place the radio into the Memory Only mode, turn the radio off. Now, **press and hold in** the **[V/M(DW)MT]** key while turning the radio on. To return to normal operation, repeat the above power-on procedure.

MEMORY MODE (REGULAR MEMORY CHANNEL)

HOME CHANNEL MEMORY

A special one-touch “HOME” channel is available for each of operating bands, to allow quick recall of a favorite operating frequency on each band.

Home Channel storage is simple to accomplish:

1. Change the setting of Set Mode Item 28: **HM/RV** from “REV” to “HOME,” if it is not already set to this option (see page 95).
2. Select the desired frequency, while operating in the VFO mode. Be sure to set up any desired CTCSS or DCS tones, as well as any desired repeater offset. The power level may also be set at this time, if you wish to store it.
3. Press and hold in the **[F/W]** key for one second.
4. While the memory channel number is blinking, just press the **[HM/RV(EMG)R/H]** key. The frequency and other data (if any) will now be stored in the special HOME channel register.
5. You may repeat this process on the other operating bands.
6. To recall the HOME channel, press the **[HM/RV(EMG)R/H]** key momentarily while operating either in the VFO or MR mode.



The UHF HOME channel is the one used during “Emergency Channel Operation.”

See page 62 for details regarding this feature.

BAND/DEFAULT	HOME CHANNEL FREQUENCY
BC Band	0.540 MHz
SW Band	1.800 MHz
50 MHz Ham Band	30.000 MHz
FM BC Band	88.000 MHz
Air Band	108.000 MHz
144 MHz Ham Band	144.000 MHz
VHF-TV Band	174.000 MHz
Action Band 1	230.000 MHz
430 MHz Ham Band	430.000 MHz
UHF-TV Band	470.000 MHz
Action Band 2	860.000 MHz

MEMORY MODE (REGULAR MEMORY CHANNEL)

MEMORY BANK OPERATION

The large number of memories available in the **VX-6E** could be difficult to utilize without some means of organizing them. Fortunately, the **VX-6E** includes provision for dividing the memories into as many as 24 Memory Banks, so you can categorize the memories in a manner convenient to you. You may enter and exit the “Memory Bank” mode by a single press of the **[BAND(SCN)BND DN]** key, as we shall see below.

Assigning Memories to a Memory Bank

1. Recall the memory channel to be assigned to a Memory Bank.
2. Press and hold in the **[F/W]** key for one second, then rotate the **DIAL** knob to select the Memory Bank number (“b 1” ~ “b24”) you want as the Memory Bank for this channel.
3. Here’s a short cut for choosing the desired Memory Bank: press and hold in the **[F/W]** key for one second, then enter the following numbers: 1101 (for Memory Bank “b1”) through 1124 (for Memory Bank “b24”).
4. Press the **[F/W]** key to copy the memory channel data into the Memory Bank.

Memory Channel	
CH 1	145,000 MHz
CH 2	145,500 MHz
CH 3	435,000 MHz
CH 4	435,500 MHz
CH 5	145,800 MHz
CH 6	435,000 MHz
CH 7	128,800 MHz
...	...
CH 897	145,620 MHz
CH 898	435,750 MHz
CH 899	128,600 MHz

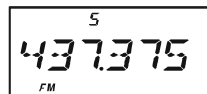

5
437.375
FM

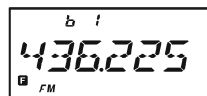

b 1
436.225
FM

Memory Bank “1”
144 MHz Amateur Band Channels

Memory Bank “2”
430 MHz Amateur Band Channels

Memory Bank “3”
All Amateur Band Channels

Memory Bank “4”
Club Channels

Memory Bank “5”
Air Band Channels





1) You may assign one

memory channel into several Memory Banks.

2) The PMS memory channels (L1/U1 through L50/U50) may not be assigned to a Memory Bank.

Memory Bank Recall

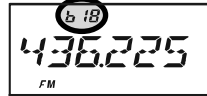
1. Press the **[V/M(DW)MT]** key, if needed, to enter the Memory mode.
2. Press the **[BAND(SCN)BND DN]** key to activate the “Memory Bank” mode. The Memory Bank number will appear on the display.
3. Press the **[F/W]** key, followed by the **[BAND(SCN)BND DN]** key, then rotate the **DIAL** knob to select the desired Memory Bank (“BANK 1” through “BANK24”).
4. Press the **[BAND(SCN)BND DN]** key momentarily once more; now, as you rotate the **DIAL** knob to select memories, you will observe that you can only select memory channels in the current memory bank. The small memory bank number will appear at the above of the frequency display while operating within a Memory Bank.
5. To change to another Memory Bank, press the **[F/W]** key, followed by the **[BAND(SCN)BND DN]** key, rotate the **DIAL** knob to select the new Memory Bank,

MEMORY BANK OPERATION

then press the [**BAND(SCN)BND DN**] key momentarily.

- To exit from Memory Bank operation, just press the [**BAND(SCN)BND DN**] key. “**MEMORY**” will appear on the display, indicating that you are now in the “standard” Memory Recall mode, without utilization of the Memory Banks. The memories stored in the various Banks will remain in those banks, however; you do not need to store them again.

Removing Memories from a Memory Bank

- Recall the memory channel to be removed from a Memory Bank.
- Press and hold in the [**F/W**] key for one second, then press the [**⊗(LK)TXPO**] key to remove the memory channel data from the Memory Bank.

Changing a Memory Bank’s Name

You may change the default Memory Bank Name which is indicates on the display while selecting the Memory Bank to your desired name.

- Press the [**F/W**] key, then press the [**0(SET)**] key to enter the Set mode.
- Rotate the **DIAL** knob to select Set Mode Item 10: **BNK NM**.
- Press the [**0(SET)**] key momentarily, then rotate the **DIAL** knob to recall the memory bank on which you wish to change a label.
- Press the [**MODE(SP S)SQ TYP**] key to enable changing of the name tag.
- Rotate the **DIAL** knob to select the first digit of the desired label.
- Press the [**MODE(SP S)SQ TYP**] key to move to the next character.
- If you make a mistake, press the [**BAND(SCN)BND DN**] key to back-space the cursor, then re-enter the correct letter, number, or symbol.
- Repeat steps 5 through 7 to program the remaining letters, numbers, or symbols of the desired label. A total of six characters may be used in the creation of a label.
- When you have programmed a name which is under 6 characters, press the [**0(SET)**] key to confirm the label.
- When you have completed the changing of the name, press the **PTT** key to save the label and exit.

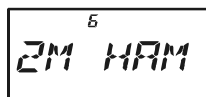
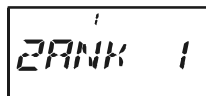
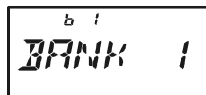
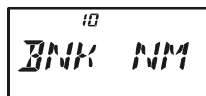

MEMORY MODE (REGULAR MEMORY CHANNELS)

DIRECT MEMORY RECALL CHANNEL

The Direct Memory Recall Channel (DMR) feature allows you to recall up to ten favorite frequencies directly via the numeric ([0] through [9]) keys. DMR channels may be selected from the VFO, an already-programmed memory, or a Home channel.

Storing the “Direct Memory Recall” Channels

1. Set up the transceiver frequency according to the desired configuration, including parameters such as CTCSS/DCS data, Repeater Shift, Power Level etc.
2. Press and hold in the numeric ([0] through [9]) key, corresponding to the Direct Memory Recall Channel into which you wish to store this configuration, for 2 seconds.
3. You still will be operating in the “normal” mode (Memory, VFO, or Home Channel), so you may now select other frequency, and store them into additional Direct Memory Recall Channels, by repeating the above process.

Recalling the “Direct Memory Recall” Channels

1. Press and hold in the [P(DMR)] key for 2 seconds to recall the Direct Memory Recall Channel mode. The “**DMR**” icon will appear at the upper left corner of the display while operating on a Direct Memory Recall Channel.

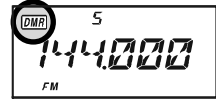

2. Press the numeric ([0] through [9]) key corresponding to the Direct Memory Recall Channel you wish to recall.
3. Once you have recalled a DMR channel, you may rotate the **DIAL** knob to change frequencies, as though you were operating on the VFO.
4. If you wish to over-write the data stored on a particular DMR channel after tuning off of the original frequency, just press and hold in (for 2 seconds) the numeric key which was pressed in step 2.

DEFAULT DMR CHANNEL	FREQUENCY
[1]	144.000 MHz
[2]	144.000 MHz
[3]	144.000 MHz
[4]	144.000 MHz
[5]	144.000 MHz
[6]	144.000 MHz
[7]	144.000 MHz
[8]	144.000 MHz
[9]	144.000 MHz
[0]	144.000 MHz

5. To exit the Direct Memory Recall Channel mode, press and hold in the [P(DMR)] key for 2 seconds.

MEMORY MODE (SPECIAL MEMORY CHANNELS)

SHORT-WAVE BROADCAST STATION MEMORY CHANNELS

A large number of Short-Wave Broadcast Station Memory Channels have also been pre-programmed at the factory, for convenient selection of broadcast stations.

1. Press the **[F/W]** key, then press the **[9(SP BNK)]** key, to recall the Special Memory Channel Bank.
2. Press the **[BAND(SCN)BND DN]** key to select “**RADIO**” (thus recalling the Broadcast Station Channel Memory Bank).
3. Rotate the **DIAL** knob to select any of the 89 available Broadcast Stations.
4. You may view the channel frequency temporarily using Set Mode Item 36: **NAME** (set its parameter to “**FREQ**”).
5. To exit to normal operation, press the **[V/M(DW)MT]** key, or press the **[F/W]** key followed by the **[9(SP BNK)]** key.

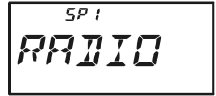

BROADCAST STATION FREQUENCY LIST

Ch No.	Freq. (MHz)	MODE	Tag	Station Name	Ch No.	Freq. (MHz)	MODE	Tag	Station Name
1	6.030	AM	VOA	Voice of America	45	7.270	AM	SPAIN	Radio Exterior de Espana
2	6.160	AM	VOA	Voice of America	46	9.520	AM	SPAIN	Radio Exterior de Espana
3	9.760	AM	VOA	Voice of America	47	11.920	AM	SPAIN	Radio Exterior de Espana
4	11.930	AM	VOA	Voice of America	48	15.585	AM	SPAIN	Radio Exterior de Espana
5	5.995	AM	CANADA	Radio Canada International	49	6.090	AM	LUXBRG	Radio Luxembourg
6	7.235	AM	CANADA	Radio Canada International	50	7.485	AM	NORWAY	Radio Norway International
7	9.735	AM	CANADA	Radio Canada International	51	9.590	AM	NORWAY	Radio Norway International
8	11.955	AM	CANADA	Radio Canada International	52	9.985	AM	NORWAY	Radio Norway International
9	6.195	AM	BBC	British Broadcasting Corporation	53	13.800	AM	NORWAY	Radio Norway International
10	9.410	AM	BBC	British Broadcasting Corporation	54	6.065	AM	SWEDEN	Radio Sweden
11	12.095	AM	BBC	British Broadcasting Corporation	55	9.490	AM	SWEDEN	Radio Sweden
12	15.310	AM	BBC	British Broadcasting Corporation	56	13.625	AM	SWEDEN	Radio Sweden
13	6.045	AM	FRANCE	Radio France International	57	17.505	AM	SWEDEN	Radio Sweden
14	9.790	AM	FRANCE	Radio France International	58	6.120	AM	FINLND	Radio Finland
15	11.670	AM	FRANCE	Radio France International	59	9.630	AM	FINLND	Radio Finland
16	15.525	AM	FRANCE	Radio France International	60	11.755	AM	FINLND	Radio Finland
17	3.955	AM	DW	Deutsche Welle	61	9.795	AM	FINLND	Radio Finland
18	6.075	AM	DW	Deutsche Welle	62	5.940	AM	RUSSIA	Voice of Russia
19	9.545	AM	DW	Deutsche Welle	63	5.920	AM	RUSSIA	Voice of Russia
20	9.735	AM	DW	Deutsche Welle	64	7.205	AM	RUSSIA	Voice of Russia
21	6.060	AM	ITALY	Italian Radio International	65	12.030	AM	RUSSIA	Voice of Russia
22	7.175	AM	ITALY	Italian Radio International	66	9.435	AM	ISRAEL	Israel Broadcasting Authority
23	9.515	AM	ITALY	Italian Radio International	67	11.585	AM	ISRAEL	Israel Broadcasting Authority
24	17.710	AM	ITALY	Italian Radio International	68	15.615	AM	ISRAEL	Israel Broadcasting Authority
25	3.985	AM	SWISS	Swiss Radio International	69	17.545	AM	ISRAEL	Israel Broadcasting Authority
26	6.165	AM	SWISS	Swiss Radio International	70	6.045	AM	INDIA	All India Radio (AIR)
27	9.885	AM	SWISS	Swiss Radio International	71	9.595	AM	INDIA	All India Radio (AIR)
28	15.220	AM	SWISS	Swiss Radio International	72	11.620	AM	INDIA	All India Radio (AIR)
29	5.985	AM	BELGIUM	Radio Vlaanderen International	73	15.020	AM	INDIA	All India Radio (AIR)
30	9.925	AM	BELGIUM	Radio Vlaanderen International	74	7.190	AM	CHINA	China Radio International (CRI)
31	11.780	AM	BELGIUM	Radio Vlaanderen International	75	5.250	AM	CHINA	China Radio International (CRI)
32	13.740	AM	BELGIUM	Radio Vlaanderen International	76	9.855	AM	CHINA	China Radio International (CRI)
33	5.955	AM	NDELND	Radio Nederland	77	11.685	AM	CHINA	China Radio International (CRI)
34	6.020	AM	NDELND	Radio Nederland	78	5.975	AM	KOREA	Radio Korea
35	9.895	AM	NDELND	Radio Nederland	79	7.275	AM	KOREA	Radio Korea
36	11.655	AM	NDELND	Radio Nederland	80	9.570	AM	KOREA	Radio Korea
37	9.590	AM	DENMRK	Radio Denmark	81	13.670	AM	KOREA	Radio Korea
38	9.985	AM	DENMRK	Radio Denmark	82	6.155	AM	JAPAN	Radio Japan
39	13.800	AM	DENMRK	Radio Denmark	83	7.200	AM	JAPAN	Radio Japan
40	15.735	AM	DENMRK	Radio Denmark	84	9.750	AM	JAPAN	Radio Japan
41	9.780	AM	PORTGL	Radio Portugal	85	11.850	AM	JAPAN	Radio Japan
42	11.960	AM	PORTGL	Radio Portugal	86	5.995	AM	ASTRLA	Radio Australia
43	15.555	AM	PORTGL	Radio Portugal	87	9.580	AM	ASTRLA	Radio Australia
44	21.655	AM	PORTGL	Radio Portugal	88	9.660	AM	ASTRLA	Radio Australia
					89	12080	AM	ASTRLA	Radio Australia

MEMORY MODE (SPECIAL MEMORY CHANNELS)

WEATHER BROADCAST CHANNELS (U. S. VERSION)

The VHF Weather Broadcast Station Memory Channel Bank has been pre-programmed at the factory, for quick selection of NOAA weather information stations.

1. Press the **[F/W]** key, then press the **[9(SP BNK)]** key, to recall the Special Memory Channel Bank.
2. Press the **[BAND(SCN)BND DN]** key, repeatedly if necessary to select “**WX CH**” (thus recalling the Weather Broadcast Memory Bank).
3. Rotate the **DIAL** knob to select the desired Weather Broadcast channel.
4. If you wish to scan this bank to search for louder stations, just press the **PTT** switch. When the scanner pauses on a station, press the **PTT** key once to halt the scan; press it once more to restart the scan.
5. To exit to normal operation, press the **[V/M(DW)MT]** key, or press the **[F/W]** key followed by the **[9(SP BNK)]** key.

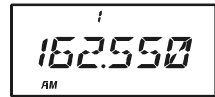
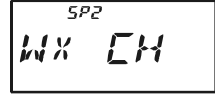

CH	FREQUENCY	CH	FREQUENCY
01	162.550 MHz	06	162.500 MHz
02	165.400 MHz	07	165.525 MHz
03	162.475 MHz	08	161.650 MHz
04	162.425 MHz	09	161.775 MHz
05	162.450 MHz	10	163.275 MHz

Severe Weather Alert

In the event of extreme weather disturbances, such as severe thunderstorms and hurricanes, the NOAA (National Oceanic and Atmospheric Administration) sends a weather alert accompanied by a 1050 Hz tone and subsequent weather report on one of the NOAA weather channels. See page 55 for details regarding activation of this mode.

MEMORY MODE (SPECIAL MEMORY CHANNELS)

VHF MARINE CHANNELS

Another special Memory Bank contains VHF Marine Channels, pre-programmed at the factory, for quick selection.

1. Press the **[F/W]** key, then press the **[9(SP BNK)]** key, to recall the Special Memory Channel Bank.
2. Press the **[BAND(SCN)BND DN]** key, repeatedly if necessary, to select “**MARINE**” (thus recalling the Marine Channel Memory Bank).
3. Rotate the **DIAL** knob to select any of the 280 available VHF Marine Channels.
4. To exit to normal operation, press the **[V/M(DW)MT]** key, or press the **[F/W]** key followed by the **[9(SP BNK)]** key.

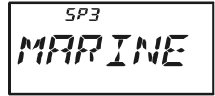

VHF MARINE CHANNEL FREQUENCY LIST

CH No.	Frequency (MHz)	CH No.	Frequency (MHz)	CH No.	Frequency (MHz)	CH No.	Frequency (MHz)	CH No.	Frequency (MHz)	CH No.	Frequency (MHz)	CH No.	Frequency (MHz)
0	156.000	41	158.050	82	157.125	123	159.075	164	160.100	205	161.125	246	155.875
1	156.050	42	158.100	83	157.175	124	159.100	165	160.125	206	161.150	247	155.850
2	156.100	43	158.150	84	157.225	125	159.125	166	160.150	207	161.175	248	155.825
3	156.150	44	158.200	85	157.275	126	159.150	167	160.175	208	161.200	249	155.800
4	156.200	45	158.250	86	157.325	127	159.175	168	160.200	209	161.225	250	155.775
5	156.250	46	158.300	87	157.375	128	159.200	169	160.225	210	161.250	251	155.750
6	156.300	47	158.350	88	157.425	129	159.225	170	160.250	211	161.275	252	155.725
7	156.350	48	158.400	89	157.475	130	159.250	171	160.275	212	161.300	253	155.700
8	156.400	49	158.450	90	157.525	131	159.275	172	160.300	213	161.325	254	155.675
9	156.450	50	158.500	91	157.575	132	159.300	173	160.325	214	161.350	255	155.650
10	156.500	51	158.550	92	157.625	133	159.325	174	160.350	215	161.375	256	155.625
11	156.550	52	158.600	93	157.675	134	159.350	175	160.375	216	161.400	257	155.600
12	156.600	53	158.650	94	157.725	135	159.375	176	160.400	217	161.425	258	155.575
13	156.650	54	158.700	95	157.775	136	159.400	177	160.425	218	161.450	259	155.550
14	156.700	55	158.750	96	157.825	137	159.425	178	160.450	219	161.475	260	155.525
15	156.750	56	158.800	97	157.875	138	159.450	179	160.475	220	161.500	261	155.500
16	156.800	57	158.850	98	157.925	139	159.475	180	160.500	221	161.525	262	155.475
17	156.850	58	158.900	99	157.975	140	159.500	181	160.525	222	161.550	263	155.450
18	156.900	59	158.950	100	158.025	141	159.525	182	160.550	223	161.575	264	155.425
19	156.950	60	156.025	101	158.075	142	159.550	183	160.575	224	161.600	265	155.400
20	157.000	61	156.075	102	158.125	143	159.575	184	160.600	225	161.625	266	155.375
21	157.050	62	156.125	103	158.175	144	159.600	185	160.625	226	161.650	267	155.350
22	157.100	63	156.175	104	158.225	145	159.625	186	160.650	227	161.675	268	155.325
23	157.150	64	156.225	105	158.275	146	159.650	187	160.675	228	161.700	269	155.300
24	157.200	65	156.275	106	158.325	147	159.675	188	160.700	229	161.725	270	155.275
25	157.250	66	156.325	107	158.375	148	159.700	189	160.725	230	161.750	271	155.250
26	157.300	67	156.375	108	158.425	149	159.725	190	160.750	231	161.775	272	155.225
27	157.350	68	156.425	109	158.475	150	159.750	191	160.775	232	161.800	273	155.200
28	157.400	69	156.475	110	158.525	151	159.775	192	160.800	233	161.825	274	155.175
29	157.450	70	156.525	111	158.575	152	159.800	193	160.825	234	161.850	275	155.150
30	157.500	71	156.575	112	158.625	153	159.825	194	160.850	235	161.875	276	155.125
31	157.550	72	156.625	113	158.675	154	159.850	195	160.875	236	161.900	277	155.100
32	157.600	73	156.675	114	158.725	155	159.875	196	160.900	237	161.925	278	155.075
33	157.650	74	156.725	115	158.775	156	159.900	197	160.925	238	161.950	279	155.050
34	157.700	75	-	116	158.825	157	159.925	198	160.950	239	161.975	280	155.025
35	157.750	76	-	117	158.875	158	159.950	199	160.975	240	162.000	281	155.000
36	157.800	77	156.875	118	158.925	159	159.975	200	161.000	241	162.025		
37	157.850	78	156.925	119	158.975	160	160.000	201	161.025	242	155.975		
38	157.900	79	156.975	120	159.000	161	160.025	202	161.050	243	155.950		
39	157.950	80	157.025	121	159.025	162	160.050	203	161.075	244	155.925		
40	158.000	81	157.075	122	159.050	163	160.075	204	161.100	245	155.900		

SCANNING

The **VX-6E** allows you to scan just the memory channels, the entire operating band, or a portion of that band. It will halt on signals encountered, so you can talk to the station(s) on that frequency, if you like.

Scanning operation is basically the same in each of the above modes. Before you begin, take a moment to select the way in which you would like the scanner to resume scanning after it halts on a signal.

Setting the Scan-Resume Technique

Three options for the Scan-Resume mode are available:

3 SEC/5 SEC/10 SEC: In this mode, the scanner will halt on a signal it encounters, and will hold there for the selected resume time. If you do not take action to disable the scanner within that time period, the scanner will resume even if the stations are still active.

BUSY: In this mode, the scanner will halt on a signal it encounters. One second after the carrier has dropped because the other station(s) ceased transmission, the scanner will resume. In the case of constant-carrier signals like Weather Station broadcasts, the scanner will likely remain on this frequency indefinitely.

HOLD: In this mode, the scanner will halt on a signal it encounters. It will not restart automatically; you must manually re-initiate scanning if you wish to resume.

To set the Scan-Resume mode:

1. Press the **[F/W]** key, then press the **[0(SET)]** key to enter the Set mode.
2. Rotate the **DIAL** knob to select Set Mode Item 49: **RESUME**.
3. Press the **[0(SET)]** key momentarily to enable adjustment of this Set Mode Item.
4. Rotate the **DIAL** knob to select the desired scan-resume mode.
5. When you have made your selection, press the **PTT** key to save the new setting and exit to normal operation.

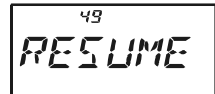

49
RESUME

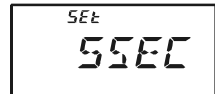

5SEC

The default condition for this Set Mode Item is “5 SEC.”

VFO SCANNING

1. Select the VFO mode by pressing the [V/M(DW)MT] key, if necessary.
2. Press and hold in the [BAND(SCN)BND DN] key for one second, then rotate the **DIAL** knob *while holding* the [BAND(SCN)BND DN] key to select the bandwidth for the VFO scanner. Available selections are ± 1 MHz, ± 2 MHz, ± 5 MHz, ALL, PMS-X, and BAND.

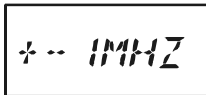

± 1 MHz, ± 2 MHz, ± 5 MHz: The scanner will sweep frequencies within the selected bandwidth.

ALL: The scanner will sweep all frequencies.

PMS-X: The scanner will sweep frequencies within the currently-selected PMS frequency pair. See page 52 for details.

Note: When an alpha-numeric “Tag” is appended to the Low sub-band limit memory channel, the alpha-numeric “Tag” will appear while you are selecting the bandwidth for the VFO scanner.

BAND: The scanner will sweep frequencies only on the current band.

3. Release the [BAND(SCN)BND DN] key to start scanning.
4. If and when the scanner encounters a signal strong enough to open the squelch, the scanner will halt temporarily; the decimal point of the frequency display will blink during this “Pause” condition.
5. The scanner will then resume according to the Scan-Resume mode selected in the previous section.
6. To cancel scanning, press the **PTT** switch or [V/M(DW)MT] key.

※: When an alpha-numeric “Tag” is appended to the Low sub-band limit memory channel, the alpha-numeric “Tag” will appear while you are selecting the bandwidth for the VFO scanner.



1) When you start the VFO Scanner, the VX-6E will be changing frequency in the upward direction. If you want to change direction of the scan while it is underway, rotate the DIAL knob one click in the opposite direction (in this case, one click counter-clockwise). You’ll see the scanner turn around and change frequency downward!

2) You may change the scanner’s method of operation so that the VFO frequency will jump to the low band edge of the next band when the VFO frequency reaches the high edge of the current band (or vice versa). See page 102 regarding Set Mode Item 71: VFO MD.

VFO SCANNING

Setting the Squelch Level during active Scanning Operation

The **VX-6E** allows adjustment of the Squelch level “on the fly” while you are scanning.

1. While the scanner is engaged, press the **[F/W]** key, then press the **MONI** key (the current squelch level (e.g. “S 1”) will appear in fine print above the frequency display).
2. Rotate the **DIAL** to select the desired Squelch level.
3. Press the **PTT** switch momentarily to save the new setting and exit to normal operation. In this case, pressing the **PTT** switch this one time will not causing scanning to stop.

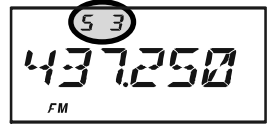

How to Skip (Omit) a Frequency during VFO Scan

If the VFO scan stops on a frequency or frequencies that you do not need (such as a spurious radiation from a television), such frequencies can be “skipped” during VFO scanning. This accomplished by storing these frequencies in a special “Frequency Skip Memory” bank reserved for this purpose.

To skip a frequency during VFO scanning:

1. While VFO *scanning* is stopped (“pause” state) on the frequency that you do not need, press and hold in the **[F/W]** key for one second, then rotate the **DIAL** knob to select the desired Frequency Skip Memory channel (**901 - 999**). The microprocessor will automatically select the next-available “free” Frequency Skip Memory channel (a memory register on which no data has been stored). Any channel with a blinking channel number is one that currently has no data written on it (i.e. the channel is “free”).
2. Press the **[F/W]** key to store the frequency into the Frequency Skip Memory; it now is programmed to be ignored during VFO scanning.

The VX-6E has 99 VFO Frequency Skip Memory Channels.

To re-institute a frequency into the VFO scan loop:

1. Press the **[V/M(DW)MT]** key, if needed, to enter the MR mode.
2. Press and hold in the **[F/W]** key for one second, then rotate the **DIAL** knob to select the memory channel to be re-instituted.
3. Press the **[⊗(LK)TXPO]** key to delete the channel from the Frequency Skip Memory; this will re-institute the frequency into the VFO scan loop.

MEMORY SCANNING

Memory scanning is similarly easy to initiate:

1. Set the radio to the Memory mode by pressing the **[V/M(DW)MT]** key, if necessary.
2. Press and hold in the **[BAND(SCN)BND DN]** key for one second, and rotate the **DIAL** knob *while holding* in the **[BAND(SCN)BND DN]** key to select the desired Memory Scan mode. Available selections are ALL CH, TAG1, TAG2, BAND, and PMS-X.

ALL CH: The scanner sweeps all Memory channels.

TAG1: The scanner sweeps only those Memory channels with the same “first” digit of the alpha/numeric tag as the *first channel on which scanning started*.

TAG2: The scanner sweeps only those Memory channels with the same “first” and “second” digits of the alpha/numeric tag as the *first channel on which scanning started*.

BAND: The scanner sweeps only those Memory channels which are memorized on the same operating band as the first channel on which scanning started.

PMS-X: The scanner will sweep frequencies within the currently-selected PMS frequency pair. See page 52 for details.

Note: When an alpha-numeric “Tag” is appended to the Low sub-band limit memory channel, the alpha-numeric “Tag” will appear while you are selecting the Memory Scan mode.

3. Release the **[BAND(SCN)BND DN]** key to initiate scanning.
4. As with VFO scanning, the scanner will halt on any signal encountered that is strong enough to open the squelch; it will then resume scanning according to the Scan-Resume mode set previously. When there are no memory channels corresponding to the selected Memory Scan mode, the “**MS ERR**” notation will appear on the display.
5. To cancel scanning, press the **PTT** switch or the **[V/M(DW)MT]** key.

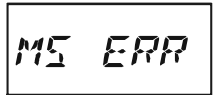

How to Skip (Omit) a Channel during Memory Scan Operation

If the scanner repeatedly stops on a memory channel due to temporary noise or interference, you can mark it to be skipped by pressing the **[F/W]** key, followed by the **[5(SKIP)]** key while the scanner has stopped on the channel to be skipped. The scanner will instantaneously resume, and that channel will not be scanned henceforth.

As mentioned previously, some continuous-carrier stations like a Weather Broadcast station will seriously impede scanner operation if you are using the “Carrier Drop” Scan-Resume mode, as the incoming signal will not pause long enough for the transceiver to resume scanning.

Here is the procedure for skipping certain memories during scanning:

1. Recall the Memory Channel to be skipped during scanning.
2. Press the **[F/W]** key, then press the **[0(SET)]** key to enter the Set mode.

MEMORY SCANNING

3. Rotate the **DIAL** knob to select Set Mode Item 57: **SKIP**.
4. Press the [**0(SET)**] key momentarily to enable adjustment of this Set Mode Item.
5. Rotate the **DIAL** knob so as to select “**SKIP**.” The current Memory Channel will now be ignored during scanning. The “**ONLY**” selection is used for “Preferential Memory Scan,” described in the next section.
6. When you have made your selection, press the **PTT** key to save the setting and exit to normal operation.

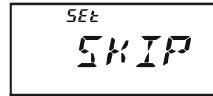
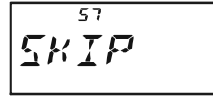

When you recall the “skipped” memory channel manually, a small “▶” icon will appear at the left of the memory channel number, indicating it is to be ignored during scanning. It is still available for recall manually, however, using the **DIAL** knob or keyboard.

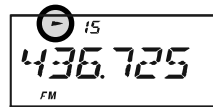

To re-institute a channel into the scanning loop, select “**OFF**” in step 5 above.

Preferential Memory Scan

The **VX-6E** also allows you to set up a “Preferential Scan List” of channels which you can “flag” within the memory system. These channels are designated by a blinking “▶” icon when you have selected them, one by one, for the Preferential Scan List.

Here is the procedure for setting up and using the Preferential Scan List:

1. Recall the Memory Channel which you wish to add to the Preferential Scan List.
2. Press the [**F/W**] key, then press the [**0(SET)**] key to enter the Set mode.
3. Rotate the **DIAL** knob to select Set Mode Item 57: **SKIP**.
4. Press the [**0(SET)**] key momentarily to enable adjustment of this Set Mode Item.
5. Rotate the **DIAL** knob so as to select “**ONLY**.”
6. When you have made your selection, press the **PTT** key to save the settings and exit to normal operation.
7. To remove a channel from the Preferential Scan List, just repeat the above procedure, rotating the **DIAL** knob to select “**OFF**” in step 5 above.

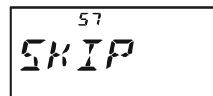

To initiate Preferential Memory Scan:

1. Press the [**V(M)DW(MT)**] key momentarily to enter the Memory Recall mode, if you are not using memories already.
2. Rotate the **DIAL** to select any channel which has a blinking “▶” icon appended to the channel number.
3. Press and hold in the [**BAND(SCN)BND DN**] key for one second, and rotate the **DIAL** knob *while holding in* the [**BAND(SCN)BND DN**] key to select the desired Memory Scan mode. Available selections are ALL CH, TAG1, TAG2, BAND, and PMS-X.

MEMORY SCANNING

ALL CH: The scanner sweeps all Preferential Memory channels.

TAG1: The scanner sweeps only those Preferential Memory channels with same “first” digit of the alpha/numeric tag as the first channel on which scanning started.

TAG2: The scanner sweeps only those Preferential Memory channels with same “first” and “second” digits of the alpha/numeric tag as the first channel on which scanning started.

BAND: The scanner sweeps only those Preferential Memory channels which are memorized on the same operating band as the first channel on which scanning started.

PMS-X: The scanner will sweep frequencies within the currently-selected PMS frequency pair. See page 52 for details.

Note: When an alpha-numeric “Tag” is appended to the Low sub-band limit memory channel, the alpha-numeric “Tag” will appear while you are selecting the Memory Scan mode.

- Release the [**BAND(SCN)BND DN**] key to initiate Preferential Memory Scanning. Only the channels which have a blinking “▶” icon appended to the channel number will be scanned.

Memory Bank Scan

When the Memory Bank feature is engaged, the scanner sweeps only memory channels in the current Memory Bank. However, if the Memory Bank Link Scan feature is enabled, you may sweep the memory channels in several Memory Banks which you have selected.

To enable the Memory Bank Link Scan feature:

- Set the radio to the Memory mode by pressing the [**V/M(DW)MT**] key, if necessary.
- Press the [**F/W**] key, followed by the [**BAND(SCN)BND DN**] key to recall the Memory Bank.
- Rotate the **DIAL** knob to select the first Memory Bank (“**BANK 1**” ~ “**BANK24**”) you wish to sweep using Memory Bank Link Scan.
- Press the [**V/M(DW)MT**] key momentarily. A small blinking “▶” icon will appear at the left of the Memory Bank number, indicating this Memory Bank will now be swept during Memory Bank Scan.
- Repeat steps 3 and 4 above, to append the blinking “▶” icon to any other Memory Banks you wish to sweep.
- Now, press and hold in the [**BAND(SCN)BND DN**] key for one second to initiate the Memory Bank Link Scan.
- To remove a Memory Bank from the Memory Bank Link Scan, repeat steps 2 and 3 above, to delete the blinking “▶” icon from the Memory Bank number indication.



SCANNING

PROGRAMMABLE (BAND LIMIT) MEMORY SCAN (PMS)

This feature allows you to set sub-band limits for either scanning or manual VFO operation. For example, you might wish to set up a limit (in North America) of 144.300 MHz to 148.000 MHz so as to prevent encroachment into the SSB/CW “Weak Signal” portion of the band below 144.300 MHz. Here’s how to do this:

1. Set the radio to the VFO mode by pressing the [V/M(DW)MT] key, if necessary.
2. Using the techniques learned earlier, store (per the above concept) 144.300 MHz into Memory Channel #L1 (the “L” designates the Lower sub-band limit).
3. Likewise, store 148.000 MHz into Memory Channel #U1 (the “U” designates the Upper sub-band limit).
4. Press and hold in the [BAND(SCN)BND DN] key for one second, and (while holding the [BAND(SCN)BND DN] key in) rotate the **DIAL** knob to select the desired PMS frequency pair (**PMSxx**), then release the [BAND(SCN)BND DN] key.
5. Releasing the [BAND(SCN)BND DN] key to initiates the Programmable (Band Limit) Memory Scan; the Memory Channel number will be replaced by “Pxx.” Scanning and tuning will now be limited within the just-programmed range.
6. 50 pairs of Band Limit memories, labeled **L1/U1** through **L50/U50** are available. You therefore can set upper and lower operation limits in multiple segments on a number of bands, if you like.
7. To exit from PMS operation, press the [V/M(DW)MT] key.

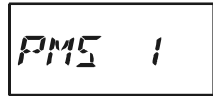

PMS 1

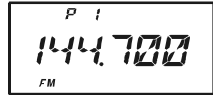

P 1
144.700
FM



Please be sure only to store limit frequencies which are on the same band and set to the same frequency steps in both the upper and lower frequency limit memories.

“PRIORITY CHANNEL” SCANNING (DUAL WATCH)

The **VX-6E**'s scanning features include a two-channel scanning capability which allows you to operate on a VFO or Memory channel, while periodically checking a user-defined Memory Channel for activity. If a station is received on the Memory Channel which is strong enough to open the Squelch, the scanner will pause on that station in accordance with the Scan-Resume mode set via Set Mode Item 49: **RESUME**. See page 46.

Here is the procedure for activating Priority Channel Dual Watch operation:

1. Press the **[V/M(DW)MT]** key momentarily to enter the Memory Recall mode, if you are not using memories already. If you are operating within a Memory Bank, you must exit from Memory Bank operation by pressing the **[BAND(SCN)BND DN]** key momentarily.
2. Press and hold in the **[F/W]** key for one second, then rotate the **DIAL** knob to select the memory channel you wish to be the “Priority” channel.
3. Press the **[BAND(SCN)BND DN]** key. The “**PRI**” icon will appear to the left side of the memory channel number, indicating it is the Priority channel while recalling the channel.
4. Now set the **VX-6E** for operation on another memory channel, Home channel, or on a VFO frequency.
5. Press and hold in the **[V/M(DW)MT]** key for one second. The display will remain on the VFO or memory channel selected; however, the “**DW**” icon will appear on the display, and every five seconds the **VX-6E** will check the Priority Channel for activity. If a station appears on the Priority Channel, the radio will pause on that channel, as described previously.
6. To exit from Dual Watch, press the **[V/M(DW)MT]** key momentarily

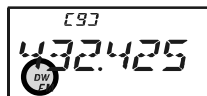
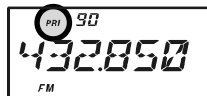

AUTOMATIC LAMP ILLUMINATION ON SCAN STOP

The **VX-6E** will automatically illuminate the LCD/Keypad Lamp whenever the scanner stops on a signal; this allows you to see the frequency of the incoming signal better at night. Note that this will, of course, increase the battery consumption, so be sure to switch it off during the day (the default condition for this feature is “ON”).

The procedure for disabling the Scan Lamp is:

1. Press the [**F/W**] key, then press the [**0(SET)**] key to enter the Set mode.
2. Rotate the **DIAL** knob to select Set Mode Item 55: **SCN.LMP**.
3. Press the [**0(SET)**] key momentarily to enable adjustment of this Set Mode Item.
4. Rotate the **DIAL** knob to set this Set Mode Item to “**OFF**.”
5. When you have made your selection, press the **PTT** key to save the setting and exit to normal operation.

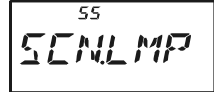

55
SCN.LMP

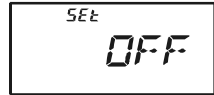

55
OFF

BAND EDGE BEEPER

The **VX-6E** will automatically “beep” when a band edge is encountered during scanning (either in standard VFO scanning or during PMS operation). You may also enable this feature (band edge beeper) to sound the beeper when the frequency reaches the band edge while tuning using the **DIAL** knob.

The procedure for enabling the Band-Edge Beeper is:

1. Press the [**F/W**] key, then press the [**0(SET)**] key to enter the Set mode.
2. Rotate the **DIAL** knob to select Set Mode Item 25: **EDG.BEP**.
3. Press the [**0(SET)**] key momentarily to enable adjustment of this Set Mode Item.
4. Rotate the **DIAL** knob to set this Set Mode Item to “**ON**.”
5. When you have made your selection, press the **PTT** key to save the setting and exit to normal operation.

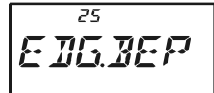

25
EDG.BEP

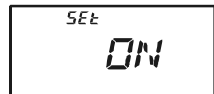

25
ON

WEATHER ALERT SCAN

This feature allows you to check the Weather Broadcast Memory Channels for the presence of the NOAA Alert Tone while operating using VFO scan or Memory channel scan.

When the Weather Alert Scan feature is engaged, the **VX-6E** will check the Weather Broadcast Memory Channels for activity every five seconds while scanning. If you watch the display carefully, you'll observe the scanner periodically shifting to the Weather Broadcast bank, scanning the Weather channels quickly in search of the Alert Tone, after which regular scanning will resume for another five seconds.

To enable the Weather Alert Scan feature:

1. Press the **[F/W]** key, then press the **[0(SET)]** key to enter the Set mode.
2. Rotate the **DIAL** knob to select Set Mode Item 73: **WX ALT**.
3. Press the **[0(SET)]** key momentarily to enable adjustment of this Set Mode Item.
4. Rotate the **DIAL** knob so as to select "**ON**."
5. When you have made your selection, press the **PTT** key to save the setting and exit to normal operation.
6. To disable the Weather Alert Scan feature, select "**OFF**" in step 4 above.

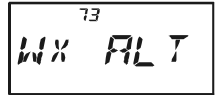



- 1) *When the Weather Alert Scan feature is engaged, the Scan-Resume mode is fixed to "TIME."*
- 2) *If you are just scanning the Weather Broadcast Channels, the VX-6E's receiver will remain muted indefinitely unless the Alert Tone is received. This yields a long period of monitoring time, as no power will be consumed via audio output while scanning for the Alert Tone is in progress.*

SMART SEARCH OPERATION

The Smart Search feature allows you to load frequencies automatically according to where activity is encountered by your radio. When Smart Search is engaged, the transceiver will search above and below your current frequency, storing active frequencies as it goes (without stopping on them even momentarily); these frequencies are stored into a special Smart Search memory bank, consisting of 31 memories (15 above the current frequency, 15 below the current frequency, plus the current frequency itself).

Two basic operating modes for Smart Search are available:

SINGLE: In this mode, the transceiver will sweep the current band once in each direction starting on the current frequency. All channels where activity is present will be loaded into the Smart Search memories; whether or not all 31 memories are filled, the search will stop after one sweep in each direction.

CONT: In this mode, the transceiver will make one pass in each direction as with One-Shot searching; if all 31 channels are not filled after the first sweep, however, the radio will continue sweeping until they are all filled.

Setting the Smart Search Mode

1. Press the [F/W] key, then press the [0(SET)] key to enter the Set mode.

2. Rotate the **DIAL** knob to select Set Mode Item 54: **S SRCH**.

3. Press the [0(SET)] key momentarily to enable adjustment of this Set Mode Item.

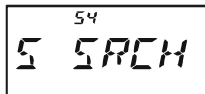

4. Rotate the **DIAL** knob to select the desired Smart Search mode (see above).



5. When you have made your selection, press the **PTT** switch to save the setting and exit to normal operation.

Storing Smart Search Memories

1. Set the radio to the VFO mode. Be sure that you have the Squelch adjusted properly (so that band noise is quieted).

2. Press and hold in the [MODE(SP S)SQ TYP] key for one second, and rotate the **DIAL** knob *while holding* in the [MODE(SP S)SQ TYP] key to that “**S SRCH**” indication appears on the display: this activates the Smart Search feature.

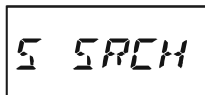

3. Press and hold in the [BAND(SCN)BND DN] key for one second to begin the Smart Search scanning.

4. As active channels are detected, you will observe the number of “loaded” channels increasing in the regular memory channel window.

5. Depending on the mode you set for Smart Search operation (“**SINGLE**” or “**CONT**”), the Smart Search scan will eventually terminate, and the LCD will revert to Smart Search Memory Channel “**C**.”



6. To recall the Smart Search memories, rotate the **DIAL** knob to choose from among the

SMART SEARCH OPERATION

frequencies stored by Smart Search.

6. To return to normal operation, press the [MODE(SP S)SQ TYP] key.



Smart Search is a great tool when visiting a city for the first time. You don't need to spend hours looking up repeater frequencies from a reference guidebook. . .just ask your VX-6E where the action is!

CHANNEL COUNTER OPERATION

The Channel Counter allows measuring of the frequency of a nearby transmitter, without knowing that frequency in advance. The frequency can be measured by bringing the **VX-6E** close to the transceiver which is transmitting.

The **VX-6E** performs a high-speed search within a ± 5 MHz range from the frequency displayed on the LCD. When the strongest signal in that range is identified, the **VX-6E** displays the frequency of that (strongest) signal, and writes it into the special “Channel Counter” memory.

Note: This Channel Counter is designed to provide an indication of the operating frequency of the incoming signal, one that is close enough to allow the user, thereafter, to tune precisely to the other station’s frequency. This feature is not, however, designed to provide a precise determination of the other station’s frequency.

1. Set the radio to the VFO mode in the predicted frequency range for the transmitter to be measured.
2. Bring the **VX-6E** into close proximity to the transmitter to be measured.
3. Press and hold in the [MODE(SP S)SQ TYP] key for one second, and rotate the **DIAL** knob *while holding* in the [MODE(SP S)SQ TYP] key to that “CH CNT” indication appears on the display: this activates the Channel Counter feature.
4. Release the [MODE(SP S)SQ TYP] key to begin the Channel Counter; the frequency of the nearby station will be displayed. When the channel counter is active, a 50 dB receiver front-end attenuator will be engaged. Therefore, only stations in close proximity may have their frequencies measured using this feature.
5. If it isn’t possible to determine the signal’s frequency, the transceiver will return to the frequency on which you were operating when you started Channel Counter operation.
6. When you are finished, just press the [MODE(SP S)SQ TYP] key. The radio will exit from Channel Counter operation.

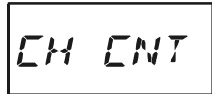

CH CNT



COUNT 3



Ent
462.526.5
FM [signal strength bars]

CHANNEL COUNTER OPERATION

Setting the Channel Counter Sweep Width

You may change the bandwidth of the Channel Counter. Available selections are ± 5 , ± 10 , ± 50 , and ± 100 MHz (default: ± 5 MHz).

Here is the procedure for setting the Channel Counter Bandwidth:

1. Press the **[F/W]** key, then press the **[0(SET)]** key to enter the Set mode.
2. Rotate the **DIAL** knob to select Set Mode Item 12: **CH CNT**.
3. Press the **[F/W]** key momentarily to enable adjustment of this Set Mode Item.
4. Rotate the **DIAL** knob to select the desired bandwidth.
5. When you have made your selection, press the **PTT** key to save the setting and exit to normal operation.

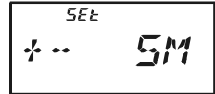
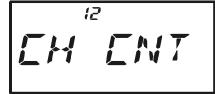

EPCS (ENHANCED PAGING & CODE SQUELCH)

The **VX-6E** includes an Enhanced CTCSS tone encoder/decoder and a dedicated micro-processor providing paging and selective calling feature. This allows you to place a call to a specific station (Paging), and to receive calls of your choice directed only to you (Code Squelch).

The paging and code squelch systems use two pairs of (alternately switched) CTCSS tones which are stored in the pager memories. Basically, your receiver remains silent until it receives the CTCSS tone pair that matches those stored in the Receiving Pager Memory. The squelch then opens so the caller is heard, and the paging ringer immediately sounds, if activated. When you close the **PTT** switch to transmit, the CTCSS tone pair which is stored in the Transmitting Pager Memory will be transmitted automatically.

On the paged radio, the squelch will close automatically after the incoming page ends. Meanwhile, on the paging radio, the Enhanced Paging and Code Squelch system will be disabled after the **PTT** switch is released after the paging transmission. You may re-activate the Enhanced Paging and Code Squelch system again using Set Mode Item 43: **PAGER**, if desired.

Storing the CTCSS Tone Pairs for EPCS Operation

1. Press the **[F/W]** key, then press the **[0(SET)]** key to enter the Set mode.
2. Rotate the **DIAL** knob to select Set Mode Item 45: **PAG.CDR** for the Receiving CTCSS Tone Pair or Set Mode Item 46: **PAG.CDT** for the Transmitting CTCSS Tone Pair.
3. Press the **[0(SET)]** key momentarily to enable adjustment of this Set Mode Item.
4. Rotate the **DIAL** knob to set the CTCSS Tone number which corresponds to the first tone of the CTCSS Tone Pair.
5. Press the **[MODE(SP S)SQ TYP]** key, then rotate the **DIAL** knob to set the CTCSS Tone number which corresponds to the second tone of the CTCSS Tone Pair.
6. Press the **PTT** switch to save the new setting and exit to normal operation.

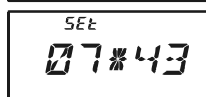
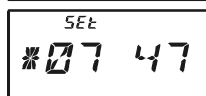
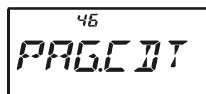
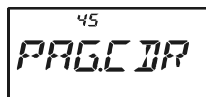

CTCSS TONE NUMBER



The VX-6E does not recognize the order of the 1st tone and the 2nd tone. In other words, for example, the VX-6E considers both CTCSS pairs "10, 35" and "35, 10" to be identical.

No.	Hz	No.	Hz	No.	Hz	No.	Hz	No.	Hz
01	67.0	11	94.8	21	131.8	31	171.3	41	203.5
02	69.3	12	97.4	22	136.5	32	173.8	42	206.5
03	71.9	13	100.0	23	141.3	33	177.3	43	210.7
04	74.4	14	103.5	24	146.2	34	179.9	44	218.1
05	77.0	15	107.2	25	151.4	35	183.5	45	225.7
06	79.7	16	110.9	26	156.7	36	186.2	46	229.1
07	82.5	17	114.8	27	159.8	37	189.9	47	233.6
08	85.4	18	118.8	28	162.2	38	192.8	48	241.8
09	88.5	19	123.0	29	165.5	39	196.6	49	250.3
10	91.5	20	127.3	30	167.9	40	199.5	50	254.1

EPCS (ENHANCED PAGING & CODE SQUELCH)

Activating the Enhanced Paging & Code Squelch System

1. Press the **[F/W]** key, then press the **[0(SET)]** key to enter the Set mode.
2. Rotate the **DIAL** knob to select Set Mode Item 43: **PAGER**.
3. Press the **[0(SET)]** key momentarily to enable adjustment of this Set Mode Item.
4. Rotate the **DIAL** knob to select “**ON**.”
5. Press the **PTT** switch to save the new setting and activate the Enhanced Paging & Code Squelch.
6. To disable the Enhanced Paging & Code Squelch, just repeat the above procedure, rotating the **DIAL** knob to select “**OFF**” in step 4 above.

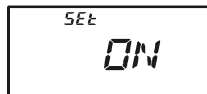
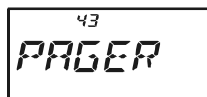

When the Enhanced Paging & Code Squelch feature is activated, the “**P**” notation will appear at the 100 MHz digit of the frequency display.

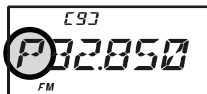

During Enhanced Paging & Code Squelch operation, you may set up the VX-6E such that a ringing “bell” sound alerts you to the fact that a call is coming in, as described previously. See page 30 for details.

Paging Answer Back

When you press the **PTT** switch to respond to a page call, the **VX-6E** transmits the same CTCSS tone pair. This tone pair will open the Code Squelch of the calling station. If you prefer, you can have the **VX-6E** respond to page calls automatically (“transpond”).

To enable this feature:

1. Press the **[F/W]** key, then press the **[0(SET)]** key to enter the Set mode.
2. Rotate the **DIAL** knob to select Set Mode Item 44: **PAG.ABK**.
3. Press the **[0(SET)]** key momentarily to enable adjustment of this Set Mode Item.
4. Rotate the **DIAL** knob to select “**ON**.”
5. Press the **PTT** switch to save the new setting and exit to normal operation.

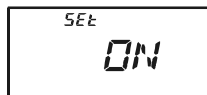
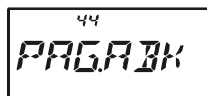

The Paging Answer Back feature constitutes a form of “remote control” operation that may be restricted to certain frequencies. U.S. users should confirm the current status of §97.201(b) of the FCC’s rules governing the Amateur service before utilizing this feature on the 144 MHz band.

EMERGENCY FEATURE

EMERGENCY CHANNEL OPERATION

The **VX-6E** includes an “Emergency” feature which may be useful if you have someone monitoring on the same frequency as your transceiver’s UHF “Home” channel. See page 39 for details on setting the Home channel.

The “Emergency” feature is activated by pressing and holding in the **[HM/RV(EMG)/R/H]** key for one second. When this is done, (A) the radio is placed on the UHF amateur band Home channel, (B) it emits a loud “Alarm” sound (the volume is controlled by the **VOL** knob), (C) it flashes the **TX/BUSY** indicator in white, (D) if you press the **PTT** switch, you will disable the Emergency feature temporarily; you can then transmit on the UHF Home channel, and (E) two seconds after the **PTT** release, the Emergency feature will resume.

To disable the “Emergency” feature, pressing and holding in the **[HM/RV(EMG)/R/H]** key for one second or turn the radio off by pressing the **POWER** switch.

Use this feature if you are out for a walk and want a quick way of alerting a family member as to a dangerous situation. The alarm sound may discourage an attacker and allow you to escape.



1) Be sure to arrange with a friend or family member to be monitoring on the same frequency, as there will be no identification sent via the Emergency alarm sound. And do not transmit the alarm tone except in a true emergency!

*2) The “Emergency” feature may be changed to another function via Set Mode Item 26: **EMG S**; see page 95 for details.*

EMERGENCY AUTOMATIC ID (EAI) FEATURE

The Emergency Automatic ID (EAI) feature can be used for searching for persons who are incapacitated in disasters like earthquakes, especially search-and-rescue personnel who may have become injured in a debris field. In such cases, if another searcher sends out a unique command (CTCSS tone pair), the radio of the incapacitated party, who may not be able to speak or even press the **PTT** switch, will automatically cause the injured party’s radio to transmit, so others may perform direction-finding and effect a rescue. The callsign of the incapacitated person will also be transmitted, to assist the rescue team.

If an emergency group is working in a dangerous area, all members should engage the EAI feature on their transceiver, so that others can provide assistance to a fallen team member, if necessary.

The Emergency Automatic ID (EAI) Feature has two operating modes: (1) Interval mode and (2) Continuous mode.

In the Interval mode, when the **VX-6E** receives the CTCSS tone pair which is stored in the Receiving Pager Code Memory (configured via Set Mode Item 45: **PAG.CDR**) on the frequency which is stored in Memory Channel “**EAI**” for more than five seconds, the radio will automatically transmit a brief (0.5 second) beep tone every 2.5 seconds until the EAI

EMERGENCY AUTOMATIC ID (EAI) FEATURE

timer expiration at the power level stored in that memory channel; it is NOT necessary for the incapacitated person to press the **PTT** switch.

In the Continuous mode, when the **VX-6E** receives the CTCSS tone pair which is stored in the Receiving Pager Code Memory (configured via Set Mode Item 45: **PAG.CDR**) on the frequency which is stored in Memory Channel “**EAI**” for more than five seconds, the radio will automatically transmit (with maximum microphone gain) *continuously*, until the EAI timer expiration, at the power level stored in that memory channel; it is NOT necessary for the incapacitated person to press the **PTT** switch.

Furthermore, if your call sign is stored in the radio and enabling the CW identifier via Set Mode Item 14: **CW ID**, the radio will transmit your callsign on the air when the EAI feature is first engaged by the remote page, and every 10 minutes thereafter. The “callsign” ID can be changed to any desired sequence of characters, such as a name. After sending the callsign or name, the radio will repeatedly transmit three tones for a user-defined period of time (between 1 and 30 minutes). The callsign or name will be transmitted every 10 minutes.

The Emergency Automatic ID (EAI) Feature requires that you (1) store the CTCSS Tone Pair into the Receiving Pager Memory (see page 60 for procedure), and (2) store the desired *UHF coordination frequency* into Memory Channel “**EAI**” (see page 34 for procedure).

Selecting the EAI mode and its Transmit Time

1. Press the **[F/W]** key, then press the **[0(SET)]** key to enter the Set mode.
2. Rotate the **DIAL** knob to select Set Mode Item 24: **EAI.TMR**.
3. Press the **[0(SET)]** key momentarily to enable adjustment of this Set Mode Item.
4. Rotate the **DIAL** knob to select the desired EAI mode (Interval EAI “**INT**” or Continuous EAI “**CON**”) and its transmit time (**1-10, 15, 20, 30, 40, and 50** minutes).
5. Press the **PTT** switch to save the new setting and exit to normal operation.

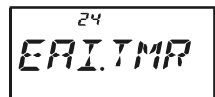

24
EAI.TMR

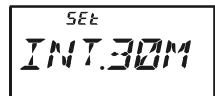

5E
INT.30M

Activating the EAI feature

1. Press the **[F/W]** key, then press the **[0(SET)]** key to enter the Set mode.
2. Rotate the **DIAL** knob to select Set Mode Item 23: **EAI**.
3. Press the **[0(SET)]** key momentarily to enable adjustment of this Set Mode Item.
4. Rotate the **DIAL** knob to select “**ON**” (thus activating the EAI feature).
5. Press the **PTT** switch to save the new setting and exit from the

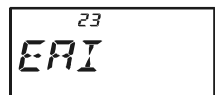

23
EAI

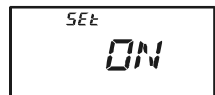

5E
ON

EMERGENCY FEATURE

EMERGENCY AUTOMATIC ID (EAI) FEATURE

Set mode. When the EAI feature is activated, the “” icon will appear at the bottom right on the LCD.



- To disable the EAI feature, just repeat above procedure, rotating the **DIAL** knob to select “**OFF**” in step “4” above.



1) Do not activate the EAI feature by pressing the [F/W] key, followed by the [8(EAI)] key. This key function is used to locate an unresponsive operator, described in the next chapter.

2) The VX-6E will ignore the EAI feature when the (1) the squelch is open, (2) there is an incoming the signal on the operating frequency, (3) the operating frequency is the same as the frequency which is stored in the Memory Channel “EAI,” or (4) a VHF frequency is stored in Memory Channel “EAI.”

To Locate an Unresponsive Operator Using the EAI feature

- Press the [F/W] key, then press the [8(EAI)] key to recall Memory Channel “EAI” (of the searched person’s radio).
- Press the [F/W] key, then press the [2(CODE)] key to enable adjustment of the Transmitting Pager Memory. Set the CTCSS tone pair which is the same CTCSS tone pair stored in the Receiving Pager Code Memory of the missing person's radio.
 - Rotate the **DIAL** knob to select the first tone.
 - Press the [BAND(SCN)BND DN] key.
 - Rotate the **DIAL** knob to select the second tone.
 - Press the **PTT** switch to save the new setting and exit from setting mode.
- Press and hold in the **PTT** switch for five seconds to find out the persons who are activating the EAI feature. The lost operator’s radio will beep loudly, and its transmitter will respond repetitively. You may now begin direction-finding efforts.
- You may select the ATT (Front End Attenuator) level among “**ATT 1** (10 dB),” “**ATT 2** (50 dB),” and “**ATT OFF**” by pressing the [BAND(SCN)BND DN] key to reduce the signal. The ATT is often useful in helping you locate the missing person’s radio, as peaks in weaker signals are more easily observed).
- Press the [F/W] key, then press the [8(EAI)] key, to exit to normal operation.

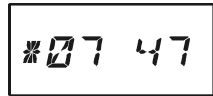

ARTS™ (AUTOMATIC RANGE TRANSPONDER SYSTEM)

The ARTS™ feature uses DCS signaling to inform both parties when you and another ARTS™-equipped station are within communications range. This may be particularly useful during Search-and Rescue situations, where it is important to stay in contact with other members of your group.

Both stations must set up their DCS codes to the same code number, then activate their ARTS™ feature using the command appropriate for their radio. Alert ringers may be activated, if desired.

Whenever you push the **PTT**, or every 25 (or 15) seconds after ARTS™ is activated, your radio will transmit a signal which includes a (subaudible) DCS signal for about 1 second. If the other radio is in range, the beeper will sound (if enabled) and the display will show “**IN RNG**” as opposed to the out of range display “**OUTRNG**” in which ARTS™ operation begins.

Whether you talk or not, the polling every 15 or 25 seconds will continue until you de-activate ARTS™. Every 10 minutes, moreover, you can have your radio transmit your callsign via CW, so as to comply with identification requirements. When ARTS™ is de-activated, DCS will also be deactivated (if you were not using it previously in non-ARTS™ operation).



If you move out of range for more than one minute (four pollings), your radio will sense that no signal has been received, three beeps will sound, and the display will revert to “**OUTRNG**.” If you move back into range, your radio will again beep, and the display will change back to the “**IN RNG**” indication.

During ARTS™ operation, it is not possible to change the operating frequency or other settings; you must terminate ARTS™ in order to resume normal operation. This is a safety feature designed to prevent accidental loss of contact due to channel change, etc.

Basic ARTS™ Setup and Operation

1. Set your radio and the other radio(s) to the same DCS code number, per the discussion on page 28.
2. Press the **[F/W]** key, then press the **[4(ARTS)]** key. You will observe the “**OUTRNG**” display on the LCD below the operating frequency. ARTS™ operation has now commenced.
3. Every 25 seconds, your radio will transmit a “polling” call to the other station. When that station responds with its own ARTS™ polling signal, the display will change to “**IN RNG**” to confirm that the other station’s polling code was received in response to yours.
4. Press the **[F/W]** key momentarily to exit ARTS™ operation and resume normal functioning of the transceiver.

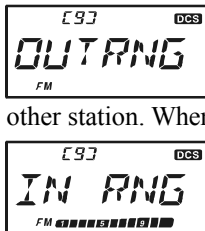

ARTS™ (AUTOMATIC RANGE TRANSPONDER SYSTEM)



ARTS™ constitutes a form of “remote control” operation that may be restricted to certain frequencies. U.S. users should confirm the current status of §97.201(b) of the FCC’s rules governing the Amateur service before utilizing this feature on the 144 MHz band.

ARTS™ Polling Time Options

The ARTS™ feature may be programmed to poll every 25 seconds (default value) or 15 seconds. The default value provides maximum battery conservation, because the polling signal is sent out less frequently. To change the polling interval:

1. Press the **[F/W]** key, then press the **[0(SET)]** key to enter the Set mode.
2. Rotate the **DIAL** knob to select Set Mode Item 3: **AR INT**.
3. Press the **[0(SET)]** key momentarily to enable adjustment of this Set Mode Item.
4. Rotate the **DIAL** knob to select the desired polling interval (15 or 25 seconds).
5. When you have made your selection, press the **PTT** switch to save the new setting and exit to normal operation.

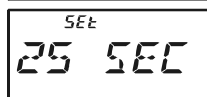
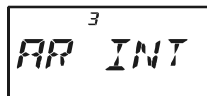

ARTS™ Alert Beep Options

The ARTS™ feature allows two kinds of alert beeps (with the additional option of turning them off), so as to alert you to the current status of ARTS™ operation. Depending on your location and the potential annoyance associated with frequent beeps, you may choose the Beep mode which best suits your needs. The choices are:

INFRANG: The beeps are issued only when the radio first confirms that you are within range, but does not re-confirm with beeps thereafter.

ALWAYS: Every time a polling transmission is received from the other station, the alert beeps will be heard.

OFF: No alert beeps will be heard; you must look at the display to confirm current ARTS™ status.

To set the ARTS™ Beep mode, use the following procedure:

1. Press the **[F/W]** key, then press the **[0(SET)]** key to enter the Set mode.
2. Rotate the **DIAL** knob to select Set Mode Item 2: **AR BEP**.
3. Press the **[0(SET)]** key momentarily to enable adjustment of this Set Mode Item.
4. Rotate the **DIAL** knob to select the desired ARTS™ Beep mode (see above).
5. When you have made your selection, press the **PTT** switch to save the new setting and exit to normal operation.

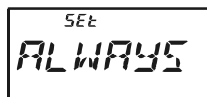
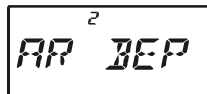

ARTS™ (AUTOMATIC RANGE TRANSPONDER SYSTEM)

CW Identifier Setup

The ARTS™ feature includes a CW identifier, as discussed previously. Every ten minutes during ARTS™ operation, the radio can be instructed to send “DE (your callsign) K” if this feature is enabled. The callsign field may contain up to 6 characters.

Here’s how to program the CW Identifier:

1. Press the **[F/W]** key, then press the **[0(SET)]** key to enter the Set mode.
2. Rotate the **DIAL** knob to select Set Mode Item 14: **CW ID**.
3. Press the **[0(SET)]** key momentarily to enable adjustment of this Set Mode Item.
4. Rotate the **DIAL** knob to set this Item to “**ON**” (to enable the CW ID function).
5. Press the **[MODE(SP S)SQ TYP]** key momentarily to display the previously stored callsign.
6. Press and hold in the **[HM/RV(EMG)R/H]** key for 2 seconds to *clear* any previous callsign.
7. Rotate the **DIAL** knob to select the first letter/number of your callsign, then press the **[MODE(SP S)SQ TYP]** key momentarily to save the first letter/number and move on to the next character.
8. Repeat the previous step, as many times as necessary, to complete your callsign. Note that the “slant bar” (—•—•) is among the available characters, should you be a “portable” station.
9. If you mistake, press the **[BAND(SCN)BND DN]** key to back-space the cursor, then re-enter the correct letter/number.
10. Press and hold in the **[HM/RV(EMG)R/H]** key for 2 seconds to delete all data after the cursor that may have been previously stored erroneously.
11. When you have entered your entire callsign, press the **[0(SET)]** key momentarily to confirm the callsign, then press the **PTT** key to save the settings and exit to normal operation.

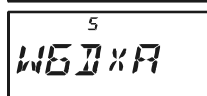
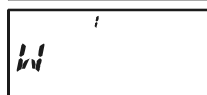
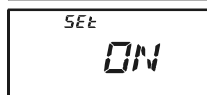
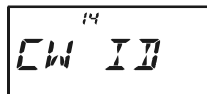

*You may check your work by monitoring the entered callsign. To do this, repeat steps 1- 7 above, then press the **[F/W]** key.*

SENSOR MODE

The **VX-6E** can display the radio's inside-the-case temperature, measured by internal sensors. Also, when the optional Barometric Pressure unit (**SU-1**) is installed, you get the unique capability of providing readout of the current barometric pressure. This information is then used for calculation of your current altitude.

The Barometric Pressure unit requires calibration of the "offset" parameters, so that differences in pressure can be used to calculate altitude. This procedure requires that you have a calculated barometer, and that you know your current altitude. If you are at sea level, of course, the latter parameter requires no research.

To display the Temperature

1. Press the **[F/W]** key, then press the **[0(SET)]** key to enter the Set mode.
2. Rotate the **DIAL** knob to select Set Mode Item 65: **TEMP**.
3. Press the **[0(SET)]** key momentarily to indicate the current temperature inside the transceiver's case.
4. Press the **[MODE(SP S)SQ TYP]** key to select the preferred unit (**F** (°F) or **C** (°C)).
5. Press the **PTT** switch to exit to normal operation.

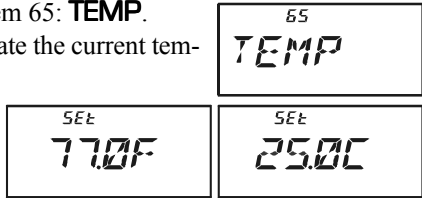

To display the Sensor Information

1. Press the **[F/W]** key, then press the **[0(SET)]** key to enter the Set mode.
2. Rotate the **DIAL** knob to select Set Mode Item 64: **SU1.SET**.
3. Press the **[0(SET)]** key momentarily to enable adjustment of this Set Mode Item.
4. Rotate the **DIAL** knob to select the sensor mode you wish to display.

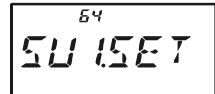

BARO: Indicates the Barometric Pressure on the frequency area and relative changes in pressure on the S-meter area (requires optional **SU-1**). After 10 minutes, if the barometric pressure rises, the "8" and "9" segments of the S-meter will blink. If the pressure goes down, the "4" and "5" segments of the S-meter will blink.

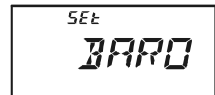

ALTI: Indicates the Altitude (requires optional **SU-1**).

OFF: Disables display of the sensor information.

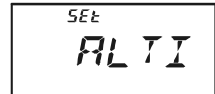

5. Press the **PTT** switch to save the new setting and display the sensor information five seconds after releasing the **PTT** switch.
6. When you operate the radio, the display will change to show the frequency information, then resume the display of the sensor information after five seconds.

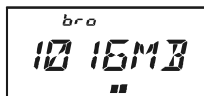

BAROMETRIC PRESSURE

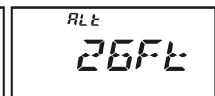
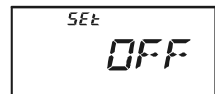

ALTITUDE

7. To disable the display of sensor information, repeat the above procedure, rotating the **DIAL** knob to select "OFF" in step 4 above.

Selecting and Correcting the Atmospheric Pressure Meter

1. Press the **[F/W]** key, then press the **[0(SET)]** key to enter the Set mode.
2. Rotate the **DIAL** knob to select Set Mode Item 63: **SU1.BRM**.
3. Press the **[0(SET)]** key momentarily to enable adjustment of this Set Mode Item.
4. Press the **[MODE(SP S)SQ TYP]** key to select the preferred units of measure (**HP** (hpa), **MB** (mbar), **HG** (mmHg), or **IC** (inches of Mercury)).
5. Press the **[F/W]** key momentarily to enable correction of the Atmospheric Pressure Meter.
6. Rotate the **DIAL** knob to adjust the **VX-6E** display to the reading on your calibrated barometer.
7. Press the **PTT** switch to save the new setting and exit to normal operation.

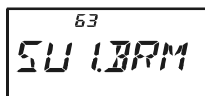

63
SU1.BRM

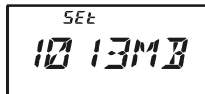

5E6
10 13MB

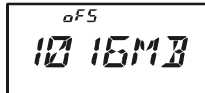

6F5
10 16MB

Selecting and Correcting the Altimeter

1. Press the **[F/W]** key, then press the **[0(SET)]** key to enter the Set mode.
2. Rotate the **DIAL** knob to select Set Mode Item 62: **SU1.ALT**.
3. Press the **[0(SET)]** key momentarily to enable adjustment of this Set Mode Item.
4. Press the **[MODE(SP S)SQ TYP]** key to select the preferred units (**M**, or **Ft**).
5. Press the **[F/W]** key momentarily to enable correction of the Altimeter.
6. Rotate the **DIAL** knob to adjust the **VX-6E** display to the true altitude at your current location.
7. Press the **PTT** switch to save the new setting and exit to normal operation.

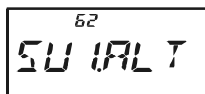

62
SU1.ALT

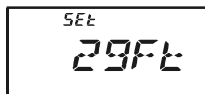

5E6
29Ft

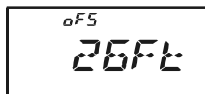

6F5
26Ft





The Barometer and Altimeter will only track correctly in the short term. That is, if you calibrate the Barometer and altitude at the beginning of a day hike, the altitude will be correctly measured during your hike. But if the radio is not used for several weeks, you will need to check the altitude correction again, because pressure changes associated with changing weather may be mis-interpreted as a change in altitude.

INTERNET CONNECTION FEATURE

The **VX-6E** can be used to access a “node” (repeater or base station) which is tied into the Vertex Standard WIRES™ (Wide-Coverage Internet Repeater Enhancement System) network. Details may be found at the WIRES-II Web site: <http://www.vxstd.com/en/wiresinfo-en/>. This feature may also be used to access other systems, as described below.

SRG (“SISTER RADIO GROUP”) MODE

1. Press the [**⊗(LK)TXPO**] key momentarily to activate the Internet Connection feature. The “⊗” icon will appear in the upper right corner of the display.
2. Rotate the **DIAL** knob while pressing the [**0(SET)**] key to select the access number (DTMF “0” ~ “9,” “A,” “B,” “C,” “D,” “E (*),” “F (#),”) corresponding to the WIRES™ node to which you wish to establish an Internet link (ask the node or repeater owner/operator if you don’t know the access number in the network). Now press the **PTT** switch to exit from the selection mode.
3. With the Internet Connection feature activated (as in step 1 above), the **VX-6E** will generate a brief (0.1 second) DTMF tone according to your selection in step 2. This DTMF tone is sent at the beginning of every transmission to establish or maintain the link to the local WIRES™ node operating in the SRG mode.
4. To disable the Internet Connection feature, press the [**⊗(LK)TXPO**] key momentarily (the “⊗” icon will disappear from the display).



If other users report that you always have a DTMF “beep” at the beginning of each transmission, and you are not operating in conjunction with Internet access, disable this function via step (4) above.

INTERNET CONNECTION FEATURE

FRG (“FRIENDLY RADIO GROUP”) MODE

You may access other Internet Link Systems (including WIRESTM in the “FRG” mode) that use a DTMF string for access.

Programming the FRG code



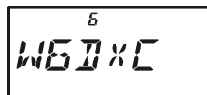
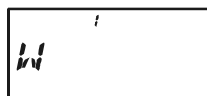
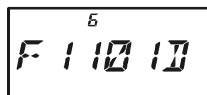
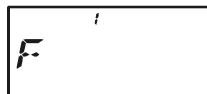
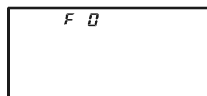
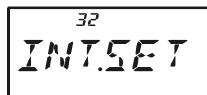

1. Load the DTMF tones which you wish to use for Internet-link access into a Internet Memory register. For purposes of this example, we will use “#(F)1101D” as the access code (the “#” key is denoted by the letter “F”).
2. Press the **[F/W]** key, then press the **[0(SET)]** key to enter the Set mode.
3. Rotate the **DIAL** knob to select Set Mode Item 32: **INT.SET**.
4. Press the **[0(SET)]** key to enable adjustment of this Set Mode Item.
5. Rotate the **DIAL** knob to select the Internet Memory register (**F 0 ~ F63**) into which you wish to store the access code.
6. Press the **[MODE(SP S)SQ TYP]** key momentarily. The first digit will blink.
7. Rotate the **DIAL** knob to select “F” (representing DTMF “#”: the first digit of the DTMF string).
8. Press the **[MODE(SP S)SQ TYP]** key momentarily to accept the first digit and move to the second digit of the DTMF string.
9. Repeat the previous steps until you have completed the access code (“#(F)1101D”).
10. If you attach an alpha/numeric name “Tag” to the Internet Memory, proceed to the next step; otherwise press and hold in the **[0(SET)]** key for one second to save the setting.
11. Press the **[V/M(DW)MT]** key momentarily to enable programming of the name tag.
12. Rotate the **DIAL** knob to select the first digit of the desired label.
13. Press the **[MODE(SP S)SQ TYP]** key to move to the next character.
14. If you make a mistake, press the **[BAND(SCN)BND DN]** key to back-space the cursor, then re-enter the correct letter, number, or symbol.
15. Repeat steps 12 through 14 to program the remaining letters, numbers, or symbols of the desired label. A total of six characters may be used in the creation of a label.
16. When you have programmed a label which is under 6 characters, press the **[0(SET)]** key to confirm the label.
17. Repeat steps 1 through 16 to store other access codes, if so desired.
18. Press the **PTT** switch to save the setting and exit to normal operation.

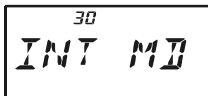

INTERNET CONNECTION FEATURE

FRG (“FRIENDLY RADIO GROUP”) MODE

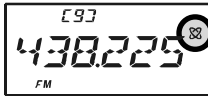
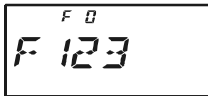
Operation (Accessing an FRG Node)

1. Press the [FW] key, then press the [0(SET)] key to enter the Set mode.
2. Rotate the **DIAL** knob to select Set Mode Item 30: **INT MD**.
3. Press the [0(SET)] key to enable adjustment of this Set Mode Item.
4. Rotate the **DIAL** knob to set this Set Mode Item to “FRG” (thus activating the “Other Internet Link System” mode).
5. Press the **PTT** switch to save the new settings.
6. Press the [⊗(LK)TXPO] key momentarily to activate the Internet Connection feature. The “⊗” icon will appear in the upper right corner of the display.
7. Rotate the **DIAL** knob while pressing the [⊗(LK)TXPO] key to select the Internet Memory register number (**F 0 ~ F63**) corresponding to the Internet link repeater to which you wish to establish an Internet link, then press the **PTT** switch momentarily to lock in the selected access number.
8. Once the Internet Connection feature is activated per step 6 above, you may now press the [0(SET)] key, while you are transmitting, to send out the selected DTMF string (to establish the link to the desired Internet-link mode).
9. To return to the WIRESTTM mode, repeat steps 1 - 5 above, selecting “SRG” in step 4.

The **VX-6E**'s 16-button keypad allows easy DTMF dialing for Autopatch, repeater control, or Internet-link access purposes. Besides numerical digits [0] through [9], the keypad includes the [*] and [#] digits, plus the [A], [B], [C], and [D] tones often used for repeater control.

Manual DTMF Tone Generation

You can generate DTMF tones during transmission manually.

1. Press the [F/W] key, followed by the the [3(DTMF)] key, then rotate the **DIAL** knob to select "MANUAL."
2. Press the [3(DTMF)] key to save the new setting and exit to normal operation.
3. Press the **PTT** switch to begin transmission.
4. While transmitting, press the desired numbers on the keypad.
5. When you have sent all the digits desired, release the **PTT** switch.



DTMF Autodialer

Nine DTMF Autodial memories are provided, allowing you to store telephone numbers for autopatch use. You can also store short autopatch or Internet-link access code streams so as to avoid having to send them manually.

Here is the DTMF Autodial storage procedure:

1. Press the [F/W] key, then press the [0(SET)] key to enter the Set mode.
2. Rotate the **DIAL** knob to select Set Mode Item 22: DT SET.
3. Press the [0(SET)] key momentarily to enable adjustment of this Set Mode Item.
4. Rotate the **DIAL** knob to select the DTMF Memory register into which you wish to store this DTMF string.
5. Press the [MODE(SP S)SQ TYP] key momentarily to begin DTMF Memory entry into the selected register.
6. Rotate the **DIAL** knob to select the first digit of the DTMF string. Selectable entries are 0 - 9, and A - F, with E and F representing DTMF "*" and "#" tones respectively.
7. Press the [MODE(SP S)SQ TYP] key to accept the first digit and move to the next digit of the DTMF string.
8. Repeat steps 5 and 6 until you have completed the telephone number.
9. If you make a mistake, press the [BAND(SCN)BND DN] key to move back to the previous digit, then re-select the correct number.
10. Press and hold in the [HM/RV(EMG)R/H] key for 2 seconds to delete all data after the cursor that may have been previously stored erroneously.
11. Press the [0(SET)] key momentarily to save the setting.

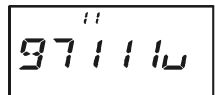
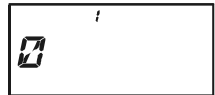
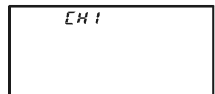
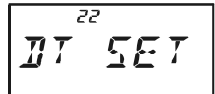

DTMF OPERATION

12. If you store other numbers, repeat steps 3- 11 above, using a different DTMF memory register.
13. When all required DTMF memories are filled to your satisfaction, press the **PTT** switch to save the settings and exit to normal operation



You may check your work by monitoring the entered DTMF string. To do this, repeat steps 1- 4 above, then press the [F/W] key.

To send the telephone number:

1. Press the [F/W] key, followed by the the [3(DTMF)] key, then rotate the **DIAL** knob to select “**AUTO**.”
2. Press the [3(DTMF)] key to save the new setting and exit to normal operation.
3. While the DTMF Autodialer is activated, first press the **PTT** switch, then press the numerical key ([1] through [9]) corresponding to the DTMF memory string you wish to send. Once the string begins, you may release the **PTT** switch, as the transmitter will be held “on the air” until the DTMF string is completed.
4. To disable the DTMF Autodialer, press the [F/W] key, followed by the the [3(DTMF)] key, then rotate the **DIAL** knob to select “**MANUAL**.”



AUTO

CW TRAINING FEATURE

The **VX-6E** provides a CW Training feature, which sends random Morse Code via the sidetone (heard in the speaker), so you can improve your CW proficiency.

1. Press the **[F/W]** key, then press the **[0(SET)]** key to enter the Set mode.
2. Rotate the **DIAL** knob to select Set Mode Item 15: **CWTRNG**.
3. Press the **[0(SET)]** key momentarily to enable adjustment of this Set Mode Item.
4. Press the **[MODE(SP S)SQ TYP]** key to select the Trainig mode (displayed in fine print at the upper edge of the LCD):

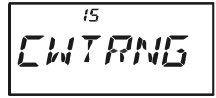

A: Sends five Alphabet charactors only

A_r: Sends Alphabet characters only (Repeatedly)

n: Sends five Numeric characters only

n_r: Sends Numeric characters only (Repeatedly)

An: Sends five Alphabet, Numeric, “?”, and “/” characters (Mixed)

Anr: Send Alphabet, Numeric, “?”, and “/” characters (Mixed, Continuously in group of five)

Trainig mode Morse Speed

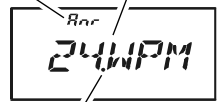

TX/BUSY Indicator Status

5. Rotate the **DIAL** knob to select the Morse speed. You may select the units of the code speed between “WPM (Words per minute)” and “CPM: characters per minute)” by pressing the **[V/M(DW)MT]** key.
6. Press the **[BAND(SCN)BND DN]** key to switch the flashing of the LED (white) on and off; a “dot” by the CW speed indicates that the LED is on.
7. Press the **[F/W]** key to bigin generation of the code characters (CW sidetone only, the radio does not transmit); the transmitted characters will appear on the display. If one of the “r” modes is not selected in step 4 above, press the **[F/W]** key to send another code group.
8. To disable the CW Training feature, press the **[0(SET)]** key momentarily.
9. Press the **PTT** switch to exit to normal operation.



The “CPM” selection is based on the international “PARIS” standard, which stipulates five characters per word.

MISCELLANEOUS SETTINGS

PASSWORD

The **VX-6E** provides a password feature which can minimize the chance that your transceiver could be used by an unauthorized party.

When the password feature is activated, the radio will ask for the four digit password to be entered when the radio is first turned on. You must enter the four digit password from the keypad. If the wrong password is entered, the microprocessor will shut down the radio automatically.



To enter the password and activating this feature, use the following procedure:

1. Press the **[F/W]** key, then press the **[0(SET)]** key to enter the Set mode.
2. Rotate the **DIAL** knob to select Set Mode Item 47: **PSWD**.
3. Press the **[0(SET)]** key momentarily to enable adjustment of this Set Mode Item.
4. Press the **[MODE(SP S)SQ TYP]** key momentarily to display any previously-stored password.
5. Rotate the **DIAL** knob to select the first digit of the desired number/letter (**0-9, A, B, C, D, E** (substitute for “*”), and **F** (substitute for “#”).
6. Press the **[MODE(SP S)SQ TYP]** key to move to the next digit.
7. Repeat steps 5 and 6 to program the remaining numbers/letters of the desired password.
8. If you make a mistake, press the **[BAND(SCN)BND DN]** key to move back to the previous digit, then re-select the correct number/letter.
9. When you have finished entering the password, press the **PTT** switch to save the new setting and exit to normal operation.
10. If you wish to disable the Password feature, repeat steps 1 - 4 above, rotating the **DIAL** knob to select “**OFF**” in step 4 above, then press the **PTT** switch.

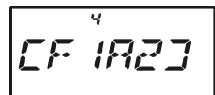
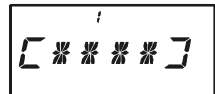
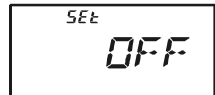
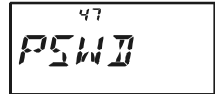

1) We recommend that you to write down the password number, and keep it in a safe place you can easily find if you forget your password.

2) If you forget the password number, you may turn on the transceiver by performing the “Microprocessor Resetting” procedure (see page 85). However, the VX-6E will clear the password, as well as all memories, and will restore all other settings to factory defaults.

MISCELLANEOUS SETTINGS

PROGRAMMING THE “P” KEY

The **VX-6E** can assign, using the Set Mode, a user-selected Menu Item to the “primary” function of the [**P(DMR)**] key.

To assign a preferred Set Mode Item to the [**P(DMR)**] key:

1. Press the [**F/W**] key, then press the [**0(SET)**] key to enter the Set mode.
2. Rotate the **DIAL** knob to select the Set Mode Item which you wish to assign to the key as a Menu short-cut.
3. Press and hold in the [**P(DMR)**] key for one second to assign the Set Mode Item to the [**P(DMR)**] key.
4. Now you can recall this preferred Set Mode Item by simply pressing the [**P(DMR)**] key momentarily.

RECEIVE BATTERY SAVER SETUP

An important feature of the **VX-6E** is its Receive Battery Saver, which “puts the radio to sleep” for a time interval, periodically “waking it up” to check for activity. If somebody is talking on the channel, the **VX-6E** will remain in the “active” mode, then resume its “sleep” cycles. This feature significantly reduces quiescent battery drain, and you may change the amount of “sleep” time between activity checks using the Set Mode:

1. Press the [**F/W**] key, then press the [**0(SET)**] key to enter the Set mode.
2. Rotate the **DIAL** knob to select Set Mode Item 53: **RXSAVE**.
3. Press the [**0(SET)**] key momentarily to enable adjustment of this Set Mode Item.
4. Rotate the **DIAL** knob to select the desired “sleep” duration. The available selections are 200 ms, 300 ms, 500 ms, 1 second, 2 seconds, or OFF. The default value is 200 ms.
5. When you have made your selection, press the **PTT** switch to save the new setting and exit to normal operation.

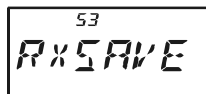

53
RXSAVE



53
200MS



When you are operating on Packet, switch the Receive Battery Saver OFF, as the sleep cycle may “collide” with the beginning of an incoming Packet transmission, causing your TNC not to receive the full data burst.

MISCELLANEOUS SETTINGS

WAKEUP FEATURE SETUP

The Wakeup feature is similarly to the Receive Battery Saver. However, it is a newer, more advanced feature which conserves battery life by providing a longer “sleep” time than the regular Receive battery Saver. The Wakeup feature, once engaged, operates while the transceiver is turned off (“**WAKEUP**” will appear on the LCD).

To set up the Wakeup feature:

1. Press the [**FW**] key, then press the [**0(SET)**] key to enter the Set mode.
2. Rotate the **DIAL** knob to select Set Mode Item 72: **WAKEUP**.
3. Press the [**0(SET)**] key momentarily to enable adjustment of this Set Mode Item.
4. Rotate the **DIAL** knob to select the desired “sleep” duration.

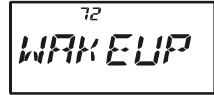

5SEC/10SEC/20SEC/30SEC:



Based on the selected time value, the radio will periodically check the operating frequency which it was on when the radio was turned off for activity. If a signal is received on the frequency which is strong enough to open the Squelch, the radio will turn itself on fully. If the EAI feature is activated when the radio was turned off, the radio also checks on the EAI frequency (Memory Channel “**EAI**”) for activity.

EAI:

Checks the EAI frequency (Memory Channel “**EAI**”) every 5 seconds. If a properly-coded signal is received on the EAI frequency, the radio will turn itself on and then automatically transmit in accordance with the setting of Set Mode Item 18: **EAI**.

OFF:

Disables the Wakeup feature.

5. When you have made your selection, press the **PTT** switch to save the new setting and exit to normal operation.
6. If you wish to disable the Wakeup feature, just repeat the above procedure, rotating the **DIAL** knob to select “**OFF**” in step 4 above.

When the radio is turned off, the Wakeup feature will be engaged, and the “**WAKEUP**” notation will be seen on the display.



You may observe a low-level “pop” noise while the Wakeup feature is polling; you may disable this popping by pressing the [**MODE(SP S)SQ TYP**] key in step 4 above (the “**SAVE**” notation will disappear). However, the battery life will be reduced somewhat.

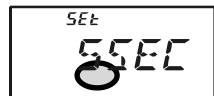

You may cancel the Wakeup feature temporarily by pressing the **PWR** switch while the Wakeup feature is engaged.

TX BATTERY SAVER

The **VX-6E** also includes a useful Transmit Battery Saver, which will automatically lower the power output level when the last signal received was very strong. For example, when you are in the immediate vicinity of a repeater station, there generally is no reason to use the High Power output selection in order to achieve full-quieting access to the repeater. With the Transmit Battery Saver, the automatic selection of Low Power operation conserves battery drain significantly.

To activate the Transmit Battery Saver:

1. Press the **[F/W]** key, then press the **[0(SET)]** key to enter the Set mode.
2. Rotate the **DIAL** knob to select Set Mode Item 70: **TXSAVE**.
3. Press the **[0(SET)]** key momentarily to enable adjustment of this Set Mode Item.
4. Rotate the **DIAL** knob to set this Set Mode Item to “**ON**” (thus activating the Transmit Battery Saver).
5. When you have made your selection, press the **PTT** switch to save the new setting and exit to normal operation.

70
TXSAVE

SEt
ON

ATT (FRONT END ATTENUATOR)

The attenuator will reduce all signals (and noise) by 10 dB, and it may be used to make reception more pleasant under extremely crowded conditions.

1. Press the **[F/W]** key, then press the **[0(SET)]** key to enter the Set mode.
2. Rotate the **DIAL** knob to select Set Mode Item 5: **ATT**.
3. Press the **[0(SET)]** key momentarily to enable adjustment of this Set Mode Item.
4. Rotate the **DIAL** knob to set this Set Mode Item to “**ON**” (thus activating the attenuator).
5. When you have made your selection, press the **PTT** switch to save the new setting and exit to normal operation.
6. If you wish to disable the attenuator, just repeat the above procedure, rotating the **DIAL** knob to select “**OFF**” in step “4” above.

5
ATT

SEt
ON





When the attenuator is activated, the Operating Mode icon (AM, FM, or WFM) will blink on the display.

MISCELLANEOUS SETTINGS



DISABLING THE TX/BUSY INDICATOR

Further battery conservation may be accomplished by disabling the **BUSY** indicator which appears while the **VX-6E** is receiving a signal. Use the following procedure:

1. Press the **[F/W]** key, then press the **[0(SET)]** key to enter the Set mode.
2. Rotate the **DIAL** knob to select Set Mode Item 11: **BSY.LED**.
3. Press the **[0(SET)]** key momentarily to enable adjustment of this Set Mode Item. 
4. Rotate the **DIAL** knob to set this Set Mode Item to "OFF" (thus disabling the **BUSY** indicator). 
5. When you have made your selection, press the **PTT** switch to save the new setting and exit to normal operation.
6. If you wish to re-enable the **BUSY** Indicator, just repeat the above procedure, rotating the **DIAL** knob to select "ON" in step 4 above.

AUTOMATIC POWER-OFF (APO) FEATURE

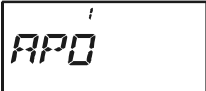
The APO feature helps conserve battery life by automatically turning the radio off after a user-defined period of time within which there has been no dial or key activity. The available selections for the time before power-off are 0.5/1/3/5/8 hours, as well as APO Off. The default condition for the APO is OFF, and here is the procedure for activating it:

1. Press the **[F/W]** key, then press the **[0(SET)]** key to enter the Set mode.
2. Rotate the **DIAL** knob to select Set Mode Item 1: **APO**.
3. Press the **[0(SET)]** key momentarily to enable adjustment of this Set Mode Item. 
4. Rotate the **DIAL** knob to select the desired time period after which the radio will automatically shut down. 
5. When you have made your selection, press the **PTT** switch to save the new setting and exit to normal operation.

When the APO is activated, the "⏻" icon will appear at the upper right corner on the LCD. If there is no action by you within the time interval programmed, the microprocessor will shut down the radio automatically. 

Press and hold in the **PWR** switch for one second, to turn the radio back on after an APO shutdown, as usual.

AUTOMATIC POWER-ON FEATURE

The **VX-6E** also includes the capability to turn itself *on* after a programmed time interval.

1. Press the **[F/W]** key, then press the **[0(SET)]** key to enter the Set mode.
2. Rotate the **DIAL** knob to select Set Mode Item 41: **ON TMR**.
3. Press the **[0(SET)]** key momentarily to enable adjustment of this Set Mode Item.
4. Rotate the **DIAL** knob to set the desired time period after which the radio will automatically turn on.

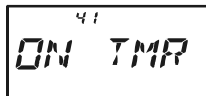

Note that this is not the time of day when the radio will turn on; it is the number of hours and minutes until the radio turns on.

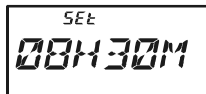

5. When you have made your selection, press the **PTT** switch to save the new setting and exit to normal operation.

When the radio is turned off, this activates the Automatic Power-On feature; a count-down timer in the display will show the time remaining until automatic switch-on.

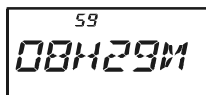

You may cancel the Automatic Power-On feature (to turn off the radio) by pressing and holding the **PWR** switch for one second while the Automatic Power-On feature is engaged.



The Automatic Power-On feature will be ignored when the Wakeup feature is activated.

MISCELLANEOUS SETTINGS

BUSY CHANNEL LOCK-OUT (BCLO)

The BCLO feature prevents the radio's transmitter from being activated if a signal strong enough to break through the "noise" squelch is present. On a frequency where stations using different CTCSS or DCS codes may be active, BCLO prevents you from disrupting their communications accidentally (because your radio may be muted by its own Tone Decoder). The default setting for the BCLO is OFF, and here is how to change that setting:

1. Press the [FW] key, then press the [0(SET)] key to enter the Set mode.
2. Rotate the **DIAL** knob to select Set Mode Item 6: **BCLO**.
3. Press the [0(SET)] key momentarily to enable adjustment of this Set Mode Item.
4. Rotate the **DIAL** knob to set this Set Mode Item to "ON" (thus activating the BCLO feature).
5. When you have made your selection, press the **PTT** switch to save the new setting and exit to normal operation.

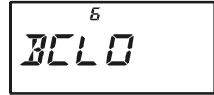

Remember that BCLO is controlled by the Noise Squelch; if you have DCS or TSQ engaged, BCLO will inhibit transmission if a station is on frequency but not transmitting the proper tone; BCLO will thus prevent you from interfering with the other station's transmission.

MISCELLANEOUS SETTINGS

TRANSMITTER TIME-OUT TIMER (TOT)

The TOT feature provides a safety switch which limits transmission time to a pre-programmed value. This will promote battery conservation by not allowing you to make excessively-long transmissions, and in the event of a stuck **PTT** switch (perhaps if the radio or a Speaker/Mic is wedged between car seats) it can prevent interference to other users as well as battery depletion. As configured at the factory the TOT feature is set to 3 minutes, and here is the procedure for activating it:

1. Press the **[F/W]** key, then press the **[0(SET)]** key to enter the Set mode.
2. Rotate the **DIAL** knob to select Set Mode Item 67: **TOT**.
3. Press the **[0(SET)]** key momentarily to enable adjustment of this Set Mode Item.
4. Rotate the **DIAL** knob to set the Time-Out Timer to the desired “Maximum TX” time (1/3/5/10 minutes), or OFF.
5. When you have made your selection, press the **PTT** switch to save the new setting and exit to normal operation.

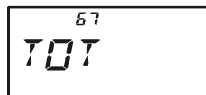

67
TOT

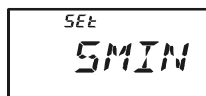

5E6
5MIN



- 1) *When your transmission time is within 10 seconds of the Time-Out Timer expiration, an Alert bell will provide an audible warning from the speaker.*
- 2) *Since brief transmissions are the mark of a good operator, try setting up your radio's TOT feature for a maximum transmission time of one minute. This will significantly improve battery life, too!*

CHANGING THE TX DEVIATION LEVEL

In many areas of the world, channel congestion has required that operating channels be closely spaced. In such operating environments, it often is required that operators use reduced deviation levels, so as to reduce the potential for interference to users on adjacent channels. The **VX-6E** includes a simple method of accomplishing this:

1. Press the **[F/W]** key, then press the **[0(SET)]** key to enter the Set mode.
2. Rotate the **DIAL** knob to select Set Mode Item 27: **HLF.DEV**.
3. Press the **[0(SET)]** key momentarily to enable adjustment of this Set Mode Item.
4. Rotate the **DIAL** knob to set this Set Mode Item to “ON.” In this configuration (HALF DEVIATION active), the transmitter's deviation will be approximately ± 2.5 kHz, and the received audio output level will be increased, for easier listening on the narrow signal.
5. When you have made your selection, press the **PTT** switch to save the new setting and exit to normal operation.

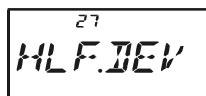

27
HLF.DEV

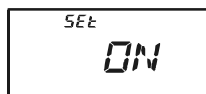

5E6
ON



- The “normal” setting for the deviation (when this Set Mode Item is set to “OFF”) is ± 5 kHz.

MISCELLANEOUS SETTINGS

NOTE

RESET PROCEDURES

In the event of erratic operation of the transceiver, it is possible that data on the microprocessor may have become corrupted. While this is a highly unusual situation, the only path to recovery may involve resetting of the microprocessor. Here's how to do this:

MICROPROCESSOR RESETTING

To clear all memories and all other settings to factory defaults:

1. Turn the radio off.
2. Press and hold in the [**MODE(SP S)SQ TYP**], [**0(SET)**], and [**V/M(DW)MT**] keys while turning the radio on.
3. Press the [**F/W**] key momentarily to reset all settings to their factory defaults (press any other key to cancel the Reset procedure).

SET MODE RESETTING

To reset the Set Mode Item settings to their factory defaults:

1. Turn the radio off.
2. Press and hold in the [**MODE(SP S)SQ TYP**] and [**V/M(DW)MT**] keys while turning the radio on.
3. Press the [**F/W**] key momentarily to reset the Set (Menu) mode settings to their factory defaults (press any other key to cancel the Reset procedure).

CLONING

The **VX-6E** includes a convenient “Clone” feature, which allows the memory and configuration data from one transceiver to be transferred to another **VX-6E**. This can be particularly useful when configuring a number of transceivers for a public service operation. Here is the procedure for Cloning one radio’s data to another:

1. Turn both radios off.
2. Connect the user-constructed cloning cable and two optional **CT-91** Microphone Adapters (one on each end) between the **MIC/SP** jacks of the two radios.
3. Press and hold in the **[F/W]** key while turning the radios on. Do this for both radios (the order of switch-on does not matter). The “**CLONE**” notation will appear on the displays of both radios.
4. On the **Destination** radio, press the **[V/M(DW)MT]** key (“**--WAIT--**” will appear on the LCD).
5. Press the **[BAND(SCN)BND DN]** key on the **Source** radio; “**---TX---**” will appear on the Source radio, and the data from this radio will be transferred to the other radio.
6. If there is a problem during the cloning process, “**ERROR**” will be displayed. Check your cable connections and battery voltage, and try again.
7. If the data transfer is successful, “**CLONE**” will reappear on the **Source** radio and the **Destination** radio will return to the normal operation. Turn both radios off and disconnect the cloning cable. You can then turn the **Source** radio back on, and begin normal operation.



CLONE



--WAIT--



---TX---



ERROR

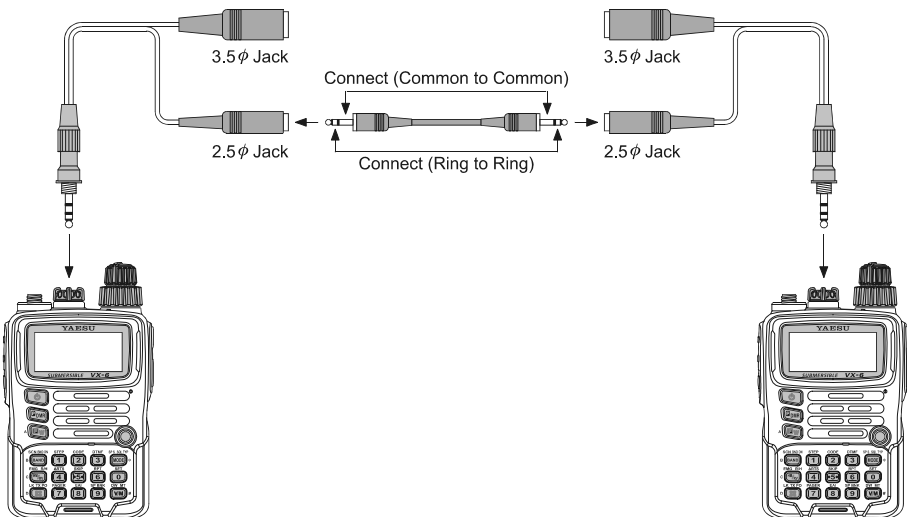

SET (MENU) MODE

The **VX-6E** Set Mode, already described in parts of many previous chapters, is easy to activate and set. It may be used for configuration of a wide variety of transceiver parameters, some of which have not been detailed previously. Use the following procedure to activate the Set Mode:

1. Press the **[F/W]** key, then press the **[0(SET)]** key to enter the Set mode.
2. Rotate the **DIAL** knob to select the Set Mode Item to be adjusted.
3. Press the **[0(SET)]** key momentarily to enable adjustment of the Set Mode Item.
4. Rotate the **DIAL** knob to adjust or select the parameter to be changed on the Set Mode Item selected in above step.
5. After completing your selection and adjustment, press the **PTT** switch momentarily to save the new setting and exit to normal operation.



*Some Set Mode Items (like Set Mode Item 50: TN FRQ) require that the **[0(SET)]** key be pressed after setting of the parameter, and before exiting to normal operation.*

“MY MENU” Short-cut Key Setup

In the factory default, the primary (press key) function of the **[⊗(LK)TXPO]** key is set to activating the Internet Connection feature. However, you may change the primary (press key) function of the **[⊗(LK)TXPO]** key to a short-cut path for recall of one of Set Mode Items.

1. Press and hold in the **[⊗(LK)TXPO]** key while turning the radio on. This procedure switches the **[⊗(LK)TXPO]** key between the “Internet Connection” function and the “MY MENU” key function.
2. Recall the Set Mode Item which you wish to assign to the **[⊗(LK)TXPO]** key as a Menu short-cut.
3. Press and hold in the **[⊗(LK)TXPO]** key for one second to assign the Set Mode Item to the **[⊗(LK)TXPO]** key. “MY KEY” will appear on the display, to confirm that the command was executed.
4. Now, a momentary press of the **[⊗(LK)TXPO]** key will immediately recall the selected Menu item. You must press the **[⊗(LK)TXPO]** key again to exit to normal operation.

SET (MENU) MODE

SET MODE ITEM	FUNCTION	AVAILABLE VALUES (DEFAULT: <i>BOLD ITALIC</i>)
1 [APO]	Setting of the Automatic Power-Off feature.	OFF / 30MIN / 1HOUR / 3HOUR / 5HOUR / 8HOUR
2 [AR BEP]	Selects the Beep option during ARTS operation.	IN RNG / ALWAYS / OFF
3 [AR INT]	Selects the Polling Interval during ARTS operation.	25 SEC / 15 SEC
4 [ARS]	Enables/Disables the Automatic Repeater Shift function.	ON / OFF
5 [ATT]	Enables/Disables the Receiver Front-end (10 dB) Attenuator.	OFF / ON
6 [BCLO]	Enables/Disables the Busy Channel Lock-Out feature.	OFF / ON
7 [BEEP]	Enables/Disables the keypad beeper.	ON / OFF
8 [BELL]	Selects the number of CTCSS/DCS Bell ringer repetitions.	OFF / 1 / 3 / 5 / 8 / CONT (Continuous ringing)
9 [BP LVL]	Adjust the Beep volume level.	LVL 1 - LVL 9 (LVL 5)
10 [BNK NM]	Stores Alpha-Numeric "Tags" for the Memory Group.	---
11 [BSY.LED]	Enables/Disables the BUSY LED while the Squelch is open.	ON / OFF
12 [CH CNT]	Selects the Channel Counter Search Width.	±5 MHz / ±10 MHz / ±50 MHz / ±100 MHz
13 [CLK.SFT]	Shifting of the CPU clock frequency.	OFF / ON
14 [CW ID]	Programs and activates the CW Identifier (used during ARTS operation).	---
15 [CWTRNG]	Enables/Disables the CW Training feature and selects the sending speed of the Morse Code.	OFF / 4WPM-13WPM / 15WPM / 17WPM / 20WPM / 24WPM / 30WPM / 40WPM (20CPM-65CPM (5CPM multiples) / 75CPM / 85CPM / 100CPM / 120CPM / 150CPM / 200CPM)
16 [DC VLT]	Indicates the DC Supply Voltage.	---
17 [DCS CD]	Setting of the DCS code.	104 standard DCS codes (023)
18 [DCS RV]	Enables/Disables "Inverted" DCS code decoding.	DISABLE / ENABLE
19 [DIMMER]	Setting of the Display brightness level.	LVL 0 - LVL 12 (LVL 7)
20 [DMR.WRT]	Enables/Disables over-written the Direct Memory Recall Channel while operating on the Direct Memory Recall Channel.	OFF / ON
21 [DT A/M]	Enables/Disables the DTMF Autodial feature.	MANUAL / AUTO
22 [DT SET]	Programming of the DTMF Autodialer.	---
23 [EAI]	Enables/Disables the Emergency Automatic ID (EAI) Feature.	OFF / ON
24 [EAI.TMR]	Setting of the Emergency Automatic ID (EAI) operating mode and its Transmit Time.	INT. 1M through INT.10M / INT.15M / INT.20M / INT.30M / INT.40M / INT. 50M CON. 1M through CON.10M / CON.15M / CON.20M / CON.30M / CON.40M / CON. 50M (CON.5M)
25 [EDG.BEP]	Enables/Disables the Band-edge beeper while selecting the frequency via the DIAL knob.	OFF / ON
26 [EMG S]	Selects the alarm(s) utilized when the Emergency function is engaged.	BP+STR / BEAM / BP+BEM / CW / BP+CW / BEEP / STROBE
27 [HLF.DEV]	Reducing the Deviation level by 50 %.	OFF / ON
28 [HM/RV]	Selects the Primary function of the [HM/RV(EMG)R/H] key.	REV / HOME
29 [INT CD]	Selects the Access Number (DTMF digit) for WIRES™ operation.	DTMF 1 - DTMF F
30 [INT MD]	Selects the Internet Link Connection mode.	SRG / FRG
31 [INT.A/M]	Enables/Disables DTMF Autodialer feature while operating on the Internet Connection feature.	MANUAL / AUTO
32 [INT.SET]	Selects the memory register for an Access Number (DTMF code) for non-WIRES™ Internet Link System access.	---
33 [LAMP]	Selects the LCD/Keypad Lamp mode.	KEY / CONT / OFF
34 [LED LT]	Illuminates the STROBE glows continuously in white.	---
35 [LOCK]	Selects the Control Locking lockout combination.	KEY / DIAL / K+D / PTT / P+K / P+D / ALL
36 [M/T-CL]	Selects the MONI switch (just below the PTT switch) function.	MONI / T-CALL ^{×1}
37 [MCGAIN]	Adjust the microphone gain level.	LVL 1 - LVL 9 (LVL 5)
38 [MW MD]	Selects the method of selection of channels for Memory Storage.	NEXT / LOWER
39 [NAME]	Toggles the display indication between "frequency" and the channel's "Alpha/Numeric Tag."	FREQ / ALPHA
40 [NM SET]	Stores Alpha-Numeric "Tags" for the Memory channels.	---

×1: Depends on the transceiver version.

SET (MENU) MODE

SET MODE ITEM	FUNCTION	AVAILABLE VALUES (DEFAULT: BOLD ITALIC)
41 [ON TMR]	Set the ON Timer time.	OFF / 00H10M (00:10) - 24H00M (24:00) (10 minutes multiples)
42 [OPN.MSG]	Selects the Opening Message that appears when the radio is powered on.	DC / MSG / OFF
43 [PAGER]	Enables/disables the Enhanced CTCSS Paging & Code Squelch function.	OFF / ON
44 [PAG.ABK]	Enables/disables the Answer Back function of the Enhanced CTCSS Paging & Code Squelch.	OFF / ON
45 [PAG.CDR]	Setting the Receiver Pager Code for the Enhanced CTCSS Paging & Code Squelch.	(05_47)
46 [PAG.CDT]	Setting the Transmitting Pager Code for the Enhanced CTCSS Paging & Code Squelch.	(05_47)
47 [PSWD]	Programs and activates the Password feature.	--
48 [PTT.DLY]	Select the time delay between when the PTT switch is pressed and the carrier is transmitted.	OFF / 20MS / 50MS / 100MS / 200MS
49 [RESUME]	Selects the Scan Resume mode.	3 SEC / 5 SEC / 10 SEC / BUSY / HOLD
50 [RF SQL]	Adjusts the RF Squelch threshold level.	OFF / S1 / S2 / S3 / S4 / S5 / S6 / S7 / S8 / S9 / S9+
51 [RPT]	Sets the Repeater Shift Direction.	SIMP / -RPT / +RPT
52 [RX MD]	Selects the receiving mode.	AUTO / N-FM / AM / W-FM
53 [RXSAVE]	Selects the Receive-mode Battery Saver interval ("sleep" ratio)	200 MS / 300 MS / 500 MS / 1 S / 2 S / OFF
54 [S SRCH]	Selects the Smart Search Sweep mode.	SINGLE / CONT
55 [SCN.LMP]	Enables/Disables the Scan lamp while paused.	ON / OFF
56 [SHIFT]	Sets the magnitude of the repeater Shift.	0.00 - 149.95 MHz*2 (50 kHz increments)
57 [SKIP]	Selects the Memory Scan "Skip" channel-selection mode.	OFF / SKIP / ONLY
58 [SPLIT]	Enables/Disables split CTCSS/DCS coding.	OFF / ON
59 [SQL]	Sets the Squelch threshold level.	LVL 0 - LVL 15 (Narrow FM: LVL 1), LVL 0 - LVL 8 (Wide FM: LVL 2)
60 [SQL.TYP]	Selects the Tone Encoder and/or Decoder mode.	OFF / TONE / T SQL / DCS / RV TN
61 [STEP]	Setting of the synthesizer steps.	5.0k / 10.0k / 12.5k / 15.0k / 20.0k / 25.0k / 50.0k / 100.0k / AUTO
62 [SU1.ALT]	Selects the measurement units for the altimeter, and correcting the altimeter.	M / Ft*1,3 Offset: -1000 - 0 - +1000
63 [SU1.BRM]	Selects the measurement units for the Barometric Pressure, and correcting the Barometric Pressure.	HP / MB / HG / IC*1,3 Offset: -1000 - 0 - +1000
64 [SU1.SET]	Selects the display of the sensor units' information.	OFF / BARO / ALTI*3
65 [TEMP]	Indicates indicate the current temperature inside the transceiver's case and selects the measurement units ("°F" or "°C") for the temperature sensor.	--
66 [TN FRQ]	Setting of the CTCSS Tone Frequency.	50 standard CTCSS tones (100 Hz)
67 [TOT]	Setting of the TOT time.	OFF / 1MIN / 3MIN / 5MIN / 10MIN
68 [TS MUT]	Enables/Disables the receiver audio output during the Tone Serch Scanner is activated.	ON / OFF
69 [TS SPD]	Selects the Tone Serch Scanner speed.	FAST / LOW
70 [TXSAVE]	Enables/Disables the Transmitter Battery Saver.	OFF / ON
71 [VFO MD]	Enables or disables the VFO band edge limiting for the current band.	BAND / ALL
72 [WAKEUP]	Setting of the Wakeup feature.	OFF / 5S / 10S / 20S / 30S / EAI
73 [WX ALT]	Enables/Disables the Weather Alert Scan feature.	OFF / ON

*1: Depends on the transceiver version.

*2: Depends on the frequency band.

*3: Requires optional **SU-1**.

SET (MENU) MODE

REPEATER SETTING	SET MODE ITEM	AVAILABLE VALUES (DEFAULT)
Enables/Disables the Automatic Repeater Shift function.	4 [ARS]	ON / OFF
Sets the Repeater Shift Direction.	51 [RPT]	SIMP / -RPT / +RPT
Sets the magnitude of the repeater Shift.	56 [SHIFT]	0.00 - 149.95 MHz*1
CTCSS/DCS SETTING	SET MODE ITEM	AVAILABLE VALUES (DEFAULT)
Selects the number of CTCSS/DCS Bell ringer repetitions.	8 [BELL]	OFF / 1 / 3 / 5 / 8 / CONT (Continuous ringing)
Setting of the DCS code.	17 [DCS CD]	104 standard DCS codes (023)
Enables/Disables "Inverted" DCS code decoding.	18 [DCS RV]	MANUAL / ENABLE
Enables/Disables the DTMF Autodial feature.	21 [DT A/M]	MANUAL / AUTO
Programming of the DTMF Autodialer.	22 [DT SET]	---
Sets the Squelch threshold level.	59 [SQL]	LVL 0 - LVL 15 (NFM: LVL 1), LVL 0 - LVL 8 (WFM: LVL 2)
Selects the Tone Encoder and/or Decoder mode.	60 [SQL.TYP]	OFF / TONE / T SQL / DCS / RV TN
Setting of the CTCSS Tone Frequency.	66 [TN FRQ]	50 standard CTCSS tones (100 Hz)
ARTS SETTING	SET MODE ITEM	AVAILABLE VALUES (DEFAULT)
Selects the Beep option during ARTS operation.	2 [AR BEP]	IN RING / ALWAYS / OFF
Selects the Polling Interval during ARTS operation.	3 [AR INT]	25 SEC / 15 SEC
Programs and activates the CW Identifier.	14 [CW ID]	--
MEMORY SETTING	SET MODE ITEM	AVAILABLE VALUES (DEFAULT)
Stores Alpha-Numeric "Tags" for the Memory Group.	10 [BNK NM]	--
Enables/Disables over-written the Direct Memory Recall Channel while operating on the Direct Memory Recall Channel.	20 [DMR.WRT]	ON / OFF
Selects the method of selection of channels for Memory Storage.	38 [MW MD]	NEXT / LOWER
Toggles the display indication between "Frequency" and the channel's "Alpha/Numeric Tag."	39 [NAME]	FREQ / ALPHA
Stores Alpha-Numeric "Tags" for the Memory channels.	40 [NM SET]	--
SCAN SETTING	SET MODE ITEM	AVAILABLE VALUES (DEFAULT)
Selects the Scan Resume mode.	49 [RESUME]	3SEC / 5SEC / 10SEC / BUSY / HOLD
Enables/Disables the Scan lamp while paused.	55 [SCN.LMP]	ON / OFF
Selects the Memory Scan "Skip+Echannel-selection mode.	57 [SKIP]	OFF / SKIP / ONLY
Enables/Disables the Weather Alert Scan feature.	73 [WX ALT]	OFF / ON
Enables/Disables the receiver audio output during the Tone Serch Scanner is activated.	68 [TS MUT]	ON / OFF
Selects the Tone Serch Scanner speed.	69 [TS SPD]	FAST / SLOW
POWER SAVING SETTING	SET MODE ITEM	AVAILABLE VALUES (DEFAULT)
Selects the Receive-mode Battery Saver interval.	53 [RXSAVE]	200 MS / 300 MS / 500 MS / 1 S / 2 S / OFF
Enables/Disables the Transmitter Battery Saver.	70 [TXSAVE]	OFF / ON
Setting of the Wakeup feature.	72 [WAKEUP]	OFF / 5S / 10S / 20S / 30S / EAI
WIRES™ SETTING	SET MODE ITEM	AVAILABLE VALUES (DEFAULT)
Selects the Access Number (DTMF digit) for WIRESTM operation.	29 [INT CD]	DTMF 1 - DTMF F
Selects the Internet Link Connection mode.	30 [INT MD]	SRG / FRG
Enables/Disables DTMF Autodialer feature while operating on the Internet Connection feature.	31 [INT.A/M]	MANUAL / AUTO
Selects the memory register for an Access Number (DTMF code) for non-WIRESTM Internet Link System access.	32 [INT.SET]	--
EAI SETTING	SET MODE ITEM	AVAILABLE VALUES (DEFAULT)
Enables/Disables the Emergency Automatic ID (EAI) Feature.	23 [EAI]	OFF / ON
Setting of the Emergency Automatic ID (EAI) operating mode and its Transmit Time.	24 [EAI.TMR]	INT. 1M through INT.10M, INT.15M, INT.20M, INT.30M, INT.40M, INT. 50M, CON. 1M through CON.10M, CON.15M, CON.20M, CON.30M, CON.40M, and CON. 50M (CON. 5M)
Selects the alarm(s) utilized when the Emergency function is engaged.	26 [EMG S]	BP+STR / BEAM / BP+BEM / CW / BP+CW / BEEP / STROBE
EPCS SETTING	SET MODE ITEM	AVAILABLE VALUES (DEFAULT)
Enables/disables the Enhanced CTCSS Paging & Code Squelch function.	43 [PAGER]	OFF / ON
Enables/disables the Answer Back function of the Enhanced CTCSS Paging & Code Squelch.	44 [PAG.ABK]	OFF / ON
Setting the Receiver Pager Code for the Enhanced CTCSS Paging & Code Squelch.	45 [PAG.CDR]	(05.47)
Setting the Transmitting Pager Code for the Enhanced CTCSS Paging & Code Squelch.	46 [PAG.CDT]	(05.47)

*1: Depends on the frequency band.

SET (MENU) MODE

SWITCH/KNOB SETTING	SET MODE ITEM	AVAILABLE VALUES (DEFAULT)
Enables/Disables the keypad beeper.	7 [BEEP]	ON / OFF
Adjust the Beep volume level.	9 [BP LVL]	LVL 1 - LVL 9 (LVL 5)
Enables/Disables the BUSY LED while the Squelch is open.	11 [BSY.LED]	ON / OFF
Selects the Primary function of the [HM/RV(EMG)R/H] key.	28 [HM/RV]	REV / HOME
Selects the LCD/Keypad Lamp mode.	33 [LAMP]	KEY / CONT / OFF
Selects the Control Locking lockout combination.	35 [LOCK]	KEY / DIAL / K+D / PTT / P+K / P+D / ALL
Selects the MONI switch (just below the PTT switch) function.	36 [M/T-CL]	MONI / T-CALL*2
SU-1 SETTING	SET MODE ITEM	AVAILABLE VALUES (DEFAULT)
Selects the measurement units for the altimeter, and correcting the altimeter.	62 [SU1.ALT]	M / Ft*2,3 Offset: -1000 - 0 - +1000
Selects the measurement units for the Barometric Pressure, and correcting the Barometric Pressure.	63 [SU1.BRM]	HP / MB / HG / IC*2,3 Offset: -1000 - 0 - +1000
Selects the display of the sensor units' information.	64 [SU1.SET]	OFF / BARO / ALTI*3
DISPLAY SETTING	SET MODE ITEM	AVAILABLE VALUES (DEFAULT)
Indicates the DC Supply Voltage	16 [DC VLT]	--
Setting of the Display brightness level.	19 [DIMMER]	LVL 0 - LVL 12 (LVL 7)
Indicates indicate the current temperature inside the transceiver's case and selects the measurement units ("F" or "C") for the temperature sensor.	65 [TEMP]	--
MISCELLANEOUS SETTING	SET MODE ITEM	AVAILABLE VALUES (DEFAULT)
Setting of the Automatic Power-Off feature.	1 [APO]	OFF / 30MIN / 1HOURL / 3HOURL / 5HOURL / 8HOURL
Enables/Disables the Receiver Front-end (10 dB) Attenuator.	5 [ATT]	OFF / ON
Enables/Disables the Busy Channel Lock-Out feature.	6 [BCLO]	OFF / ON
Selects the Channel Counter Search Width.	12 [CH CNT]	±5 MHz / ±10 MHz / ±50 MHz / ±100 MHz
Shifting of the CPU clock frequency.	13 [CLK.SFT]	OFF / ON
Enables/Disables the CW Training feature and selects the sending speed of the Morse Code.	15 [CWTRNG]	OFF / 4WPM-13WPM / 15WPM / 17WPM / 20WPM / 24WPM / 30WPM / 40WPM (20CPM - 65CPM (5CPM multiples) / 75CPM / 85CPM / 100CPM / 120CPM / 150CPM / 200CPM)
Enables/Disables the Band-edge beeper while selecting the frequency via the DIAL knob.	25 [EDG.BEP]	OFF / ON
Reducing the Deviation level by 50 %.	27 [HLF.DEV]	OFF / ON
Illuminates the STROBE glows continuously in white.	34 [LED LT]	---
Adjust the microphone gain level.	37 [MCGAIN]	LVL 1 - LVL 10 (LVL 5)
Set the ON Timer time.	41 [ON TMR]	OFF / 00H10M (00:10) - 24H00M (24:00) (10 minutes multiples)
Selects the Opening Message that appears when the radio is powered on.	42 [OPN.MSG]	DC / MSG / OFF
Programs and activates the Password feature.	47 [PSWD]	--
Select the time delay between when the PTT switch is pressed and the carrier is transmitted.	48 [PTT.DLY]	OFF / 20MS / 50MS / 100MS / 200MS
Adjusts the RF Squelch threshold level.	50 [RF SQL]	OFF / S1 / S2 / S3 / S4 / S5 / S6 / S7 / S8 / S9 / S9+
Selects the receiving mode.	52 [RX MD]	AUTO / N-FM / AM / W-FM
Selects the Smart Search Sweep mode.	54 [S SRCH]	SINGLE / CONT
Enables/Disables split CTCSS/DCS coding.	58 [SPLIT]	OFF / ON
Setting of the synthesizer steps.	61 [STEP]	5.0k / 10.0k / 12.5k / 15.0k / 20.0k / 25.0k / 50.0k / 100.0k / AUTO
Setting of the TOT time	67 [TOT]	OFF / 1MIN / 3MIN / 5MIN / 10MIN
Enables or disables the VFO band edge limiting for the current band.	71 [VFO MD]	BAND / ALL

*1: Depends on the frequency band.

*2: Depends on the transceiver version.

*3: Requires optional SU-1.

SET (MENU) MODE

Set Mode Item 1 [APO]

Function: Setting of the Automatic Power-Off feature.

Available Values: OFF/30MIN/1HOUR/3HOUR/5HOUR/8HOUR

Default: OFF

Set Mode Item 2 [AR BEP]

Function: Selects the Beep option during ARTS operation.

Available Values: INRANG/ALWAYS/OFF

Default: INRANG

INRANG: Beeps sound only when the radio first detects that you are within range.

ALWAYS: Beeps sound every time a polling transmission is received from the other station (every 15 or 25 seconds when in range).

OFF: No alert beeps sound.

Set Mode Item 3 [AR INT]

Function: Selects the Polling Interval during ARTS operation.

Available Values: 25 SEC/15 SEC

Default: 25SEC

Set Mode Item 4 [ARS]

Function: Enables/Disables the Automatic Repeater Shift function.

Available Values: ARS. ON/ARS.OFF

Default: ARS. ON

Set Mode Item 5 [ATT]

Function: Enables/Disables the Receiver Front-end (10 dB) Attenuator.

Available Values: OFF/ON

Default: OFF

Set Mode Item 6 [BCLO]

Function: Enables/Disables the Busy Channel Lock-Out feature.

Available Values: OFF/ON

Default: OFF

Set Mode Item 7 [BEEP]

Function: Enables/Disables the keypad beeper.

Available Values: ON/OFF

Default: ON

Set Mode Item 8 [BELL]

Function: Selects the number of CTCSS/DCS Bell ringer repetitions.

Available Values: OFF/1/3/5/8/CONT (Continuous ringing)

Default: OFF

Set Mode Item 9 [BP LVL]

Function: Adjust the Beep volume level.

Available Values: LVL 1 - LVL 10

Default: LVL 5

Set Mode Item 10 [BNK NM]

Function: Stores Alpha-Numeric “Tags” for the Memory Group.

See page 41 for details.

Set Mode Item 11 [BSY.LED]

Function: Enables/Disables the **BUSY** LED while the Squelch is open.

Available Values: ON/OFF

Default: ON

Set Mode Item 12 [CH CNT]

Function: Selects the Channel Counter Search Width.

Available Values: ± 5 MHz/ ± 10 MHz/ ± 50 MHz/ ± 100 MHz

Default: ± 5 MHz

Set Mode Item 13 [CLK.SFT]

Function: Shifting of the CPU clock frequency.

Available Values: OFF/ON

Default: OFF

This function is only used to move a spurious response “birdie,” should it fall on a desired frequency.

Set Mode Item 14 [CW ID]

Function: Programs and activates the CW Identifier (used during ARTS operation).

See page 67 for details.

Set Mode Item 15 [CWTRNG]

Function: Enables/Disables the CW Training feature and selects the sending speed of the Morse Code character groups.

Available Values: OFF/4/5/6/7/8/9/10/11/12/13/15/17/20/24/30/40 WPM or
OFF/20/25/30/35/40/45/50/55/60/65/75/85/100/120/150/200 CPM

Default: OFF

Note: To switch units between “WPM” and “CPM,” just press the [V/M(DW)MT] key.

Set Mode Item 16 [DC VLT]

Function: Indicates the DC Supply Voltage.

SET (MENU) MODE

Set Mode Item 17 [DCS CD]

Function: Setting of the DCS code.

Available Values: 104 standard DCS codes

Default: 023

DCS CODE									
023	025	026	031	032	036	043	047	051	053
054	065	071	072	073	074	114	115	116	122
125	131	132	134	143	145	152	155	156	162
165	172	174	205	212	223	225	226	243	244
245	246	251	252	255	261	263	265	266	271
274	306	311	315	325	331	332	343	346	351
356	364	365	371	411	412	413	423	431	432
445	446	452	454	455	462	464	465	466	503
506	516	523	526	532	546	565	606	612	624
627	631	632	654	662	664	703	712	723	731
732	734	743	754	-	-	-	-	-	-

Set Mode Item 18 [DCS RV]

Function: Enables/Disables “Inverted” DCS code decoding.

Available Values: DISABL/ENABLE

Default: DISABL

Set Mode Item 19 [DIMMER]

Function: Setting of the Display brightness level.

Available Values: LVL 0 - LVL 12

Default: LVL 7

Set Mode Item 20 [DMR.WRT]

Function: Enables/Disables over-writing of the Direct Memory Recall Channels while operating on a Direct Memory Recall Channel.

Available Values: ON/OFF

Default: ON

Set Mode Item 21 [DT A/M]

Function: Enables/Disables the DTMF Autodial feature.

Available Values: MANUAL/AUTO

Default: MANUAL

Set Mode Item 22 [DT SET]

Function: Programming of the DTMF Autodialer.

See page 73 for details.

Set Mode Item 23 [EAI]

Function: Enables/Disables the Emergency Automatic ID (EAI) Feature.

Available Values: OFF/ON

Default: OFF

Set Mode Item 24 [EAI.TMR]

Function: Setting of the Emergency Automatic ID (EAI) operating mode and its Transmit Time.

Available Values:

INT. 1M through INT.10M, INT.15M, INT.20M, INT.30M, INT.40M, INT. 50M,

CON. 1M through CON.10M, CON.15M, CON.20M, CON.30M, CON.40M, and CON. 50M

Default: CON. 5M

Set Mode Item 25 [EDG.BEP]

Function: Enables/Disables the Band-edge Beeper while selecting the frequency via the **DIAL** knob.

Available Values: OFF/ON

Default: OFF

Set Mode Item 26 [EMG S]

Function: Selects the alarm(s) utilized when the Emergency function is engaged.

Available Values: BP+STR/BEAM/BP+BEM/CW/BP+CW/BEEP/STROBE

Default: BP+STR

BP+STR: Loud “Alarm” sounds and the **TX/BUSY** indicator flashes.

BEAM: The **TX/BUSY** indicator glows continuously in white.

BP+BEM: Loud “Alarm” sounds and the **TX/BUSY** indicator glows continuously in white.

CW: Transmits the Morse Code “SOS” (•••---•••) message on the air beginning one minute after activation of the Emergency function.

BP+CW: Loud “Alarm” sounds and the Morse Code “SOS” (•••---•••) message is transmitted on the air beginning one minute after activation of the Emergency function.

BEEP: Loud “Alarm” sounds.

STROBE: The **TX/BUSY** indicator lamp flashes.

When the radio is set to the CW or BP+CW mode, the radio will be instructed to send “DE (your callsign)” after the sending of the SOS message, if your callsign is entered via Set Mode Item 14: **CW ID**.

Set Mode Item 27 [HLF.DEV]

Function: Reducing the Deviation level by 50 %.

Available Values: OFF/ON

Default: OFF

Set Mode Item 28 [HM/RV]

Function: Selects the Primary function of the [**HM/RV(EMG)R/H**] key.

Available Values: REV/HOME

Default: REV

REV: Pressing the [**HM/RV(EMG)R/H**] key reverses the transmit and receive frequencies during repeater operation.

HOME: Pressing the [**HM/RV(EMG)R/H**] key instantly recalls a favorite “Home” channel.

Set Mode Item 29 [INT CD]

Function: Selects the Access Number (DTMF digit) for WIRES™ operation.

Available Values: DTMF 1 - DTMF F

Default: DTMF 1

SET (MENU) MODE

Set Mode Item 30 [INT MD]

Function: Selects the Internet Link Connection mode.

Available Values: SRG/FRG

Default: SRG (Single DTMF Digit is appended at the beginning of each transmission)

Set Mode Item 31 [INT.A/M]

Function: Enables/Disables the DTMF Autodialer feature while operating using the Internet Connection feature.

Available Values: MANUAL/AUTO

Default: MANUAL

Set Mode Item 32 [INT.SET]

Function: Selects the memory register for an Access Number (DTMF code) for non-WIRES™ Internet Link System access.

Available Values: F 0 - F63

Default: F 1

Set Mode Item 33 [LAMP]

Function: Selects the LCD/Keypad Lamp mode.

Available Values: KEY/CONT/OFF

Default: KEY

KEY: Illuminates the Keypad/LCD for five seconds when you rotate the **DIAL** knob or press any key or switch (except the **PTT** switch).

CONT: Illuminates the Keypad/LCD continuously.

OFF: Disables the Keypad/LCD lamp illumination.

Set Mode Item 34 [LED LT]

Function: Illuminates the **STROBE** glows continuously in white (useful as emergency flashlight at night).

Set Mode Item 35 [LOCK]

Function: Selects the Control Locking lockout combination.

Available Values: KEY/DIAL/K+D/PTT/P+K/P+D/ALL

Default: K+D

Note: “K” = “Key;” “D” = “Dial;” and “P” = “PTT.”

Set Mode Item 36 [M/T-CL]

Function: Selects the **MONI** switch (just below the **PTT** switch) function.

Available Values: MONI/T-CALL

Default: T-CALL

MONI: Pressing the **MONI** switch causes the Noise/Tone Squelch to be over-ridden, allowing you to listen for weak (or non-encoded) signals.

T-CALL: Pressing the **MONI** switch activates a 1750-Hz burst tone, used for repeater access in many countries (especially in Europe).

Set Mode Item 37 [MCGAIN]

Function: Adjust the microphone gain level.

Available Values: LVL 1 - LVL 10

Default: LVL 5

Set Mode Item 38 [MW MD]

Function: Selects the method of selection of channels for Memory Storage.

Available Values: NEXT/LOWER

Default: NEXT

NEXT: Stores the data into the memory channel which is next-highest from the *last-stored* memory channel.

LOWER: Stores the data into the lowest-available “free” channel.

Set Mode Item 39 [NAME]

Function: Toggles the display indication between “frequency” and the channel’s “Alpha/Numeric Tag.”

Available Values: FREQ/ALPHA

Default: FREQ

Set Mode Item 40 [NM SET]

Function: Stores Alpha-Numeric “Tags” for the Memory channels.

See page 35 for details.

Set Mode Item 41 [ON TMR]

Function: Set the ON Timer time.

Available Values: OFF/00H10M (00:10) - 24H00M (24:00) (10 minutes multiples)

Default: OFF

The ON Timer turns on the radio at the programmed time.

SET (MENU) MODE

Set Mode Item 42 [OPN.MSG]

Function: Selects the Opening Message that appears when the radio is powered on.

Available Values: DC/MSG/OFF

Default: DC

DC: DC supply voltage

MSG: Set by user. See below.

OFF: No Opening Message

Here's how to program the Opening Message:

1. Set this Set Mode Item to "**MSG**."
2. Press the [**MODE(SPS)SQ TYP**] key momentarily to enable programming of the opening message. You will notice the first character entry's location blinking.
3. Rotate the **DIAL** knob to select the first letter/number of the message, then press the [**MODE(SPS)SQ TYP**] key momentarily to save the first letter/number and move on to the next character.
4. Repeat the previous step as necessary to complete the message (up to six characters).
5. If you make a mistake, press the [**BAND(SCN)BND DN**] key to back-space the cursor; now re-enter the correct letter/number.
6. When you have entered the desired opening message, press the [**0(SET)**] key momentarily to confirm the message, then press the **PTT** key to save the settings and exit to normal operation.

Set Mode Item 43 [PAGER]

Function: Enables/disables the Enhanced CTCSS Paging & Code Squelch function.

Available Values: OFF/ON

Default: OFF

Set Mode Item 44 [PAG.ABK]

Function: Enables/disables the Answer Back function of the Enhanced CTCSS Paging & Code Squelch.

Available Values: OFF/ON

Default: OFF

Set Mode Item 45 [PAG.CDR]

Function: Setting the Receiver Pager Code for the Enhanced CTCSS Paging & Code Squelch.

See page 60 for details.

Set Mode Item 46 [PAG.CDT]

Function: Setting the Transmitting Pager Code for the Enhanced CTCSS Paging & Code Squelch.

See page 60 for details.

Set Mode Item 47 [PSWD]

Function: Programs and activates the Password feature.
See page 76 for details.

Set Mode Item 48 [PTT.DLY]

Function: Select the time delay between when the **PTT** switch is pressed and the carrier is transmitted.

Available Values: OFF/20MS/50MS/100MS/200MS

Default: OFF

Set Mode Item 49 [RESUME]

Function: Selects the Scan Resume mode.

Available Values: 3SEC/5SEC/10SEC/BUSY/HOLD

Default: 5SEC

3SEC/5SEC/10SEC: The scanner will hold for the selected resume time, then resume whether or not the other station is still transmitting.

BUSY: The scanner will hold until the signal disappears, then will resume when the carrier drops.

HOLD: The scanner will stop when a signal is received, and will not restart.

Set Mode Item 50 [RF SQL]

Function: Adjusts the RF Squelch threshold level.

Available Values: OFF/S1/S2/S3/S4/S5/S6/S7/S8/S9/S9+

Default: OFF

Set Mode Item 51 [RPT]

Function: Sets the Repeater Shift Direction.

Available Values: -RPT/+RPT/SIMP

Default: Depends on the transceiver version, as well as the setting of Set Mode Item 4: **ARS**.

Set Mode Item 52 [RX MD]

Function: Selects the receiving mode.

Available Values: AUTO/N-FM/AM/W-FM

Default: AUTO (Mode automatically changes according to operating frequency)

Set Mode Item 53 [RXSAVE]

Function: Selects the Receive-mode Battery Saver interval (“sleep” ratio)

Available Values: 200 MS(1:1)/300 MS(1:1.5)/500 MS(1:2.5)/1 S(1:5)/2 S(1:10)/OFF

Default: 200 MS

SET (MENU) MODE

Set Mode Item 54 [S SRCH]

Function: Selects the Smart Search Sweep mode.

Available Values: SINGLE/CONT

Default: SINGLE

SINGLE: The transceiver sweeps the current band once in each direction, starting on the current frequency. All channels where activity is present (up to 15 in each direction) are loaded into the Smart Search memories. Whether or not all 31 memories are filled, the search stops after one sweep in each direction.

CONT: The transceiver makes a sweep in each direction as with the “SINGLE” mode, but if all 31 channels are not filled after the first sweep, the radio continues sweeping until they *are* all filled.

Set Mode Item 55 [SCN.LMP]

Function: Enables/Disables the Scan lamp while paused.

Available Values: ON/OFF

Default: ON

Set Mode Item 56 [SHIFT]

Function: Sets the magnitude of the repeater Shift.

Available Values: 0.00 - 149.95 MHz (50 kHz increments)

Default: Depends on the operating band and transceiver version.

Set Mode Item 57 [SKIP]

Function: Selects the Memory Scan “Skip” channel-selection mode.

Available Values: OFF/SKIP/ONLY

Default: OFF

SKIP: The scanner will “skip” the flagged channels during scanning.

ONLY: The scanner will *only* scan channels that are flagged (Preferential Scan List).

OFF: All memory channels will be scanned (the “flag” will be ignored).

Set Mode Item 58 [SPLIT]

Function: Enables/Disables Split CTCSS/DCS coding.

Available Values: OFF/ON

Default: OFF

When this Set Mode Item is set to “ON,” you will see the following additional parameters after the “RV TN” parameter while configuring Set Mode Item 60: **SQL.TYP.**

D CODE: DCS Encode only.

T DCS: Encodes a CTCSS tone and Decodes a DCS code.

D TONE: Encodes a DCS code and Decodes a CTCSS tone.

Select the desired operating mode from the selections shown above.

Set Mode Item 59 [SQL]

Function: Sets the Squelch threshold level.

Available Values: LVL 0 - LVL 15 (Narrow FM), LVL 0 - LVL 8 (Wide FM)

Default: LVL 1 (Narrow FM), LVL 2 (Wide FM)

Set Mode Item 60 [SQL.TYP]

Function: Selects the Tone Encoder and/or Decoder mode.

Available Values: OFF/TONE/T SQL/DCS/RV TN

Default: OFF

TONE: CTCSS Encoder

TSQL: CTCSS Encoder/Decoder

DCS: Digital Coded Encoder/Decoder

RV TN: Reverse CTCSS Decoder (Mutes receiver when matching tone is received)

Note: See also Set Mode Item 58: **SPLIT** regarding additional selections available during “Split Tone” operation.

Set Mode Item 61 [STEP]

Function: Setting of the synthesizer steps.

Available Values: 5.0k/10.0k/12.5k/15.0k/20.0k/25.0k/50.0k/100.0k, or AUTO

Default: AUTO (Step automatically changes according to operating frequency.)

Set Mode Item 62 [SU1.ALT]

Function: Selects the measurement units for the altimeter (require optional **SU-1**), and correcting the altimeter.

Available Values: M (meter)/Ft (feet), offset: -1000 to +1000

Default: Depends on the transceiver version.

Note: “**OPTION**” will be displayed if the **SU-1** is not installed.

Set Mode Item 63 [SU1.BRM]

Function: Selects the measurement units for the Barometric Pressure (require optional **SU-1**), and correction of the Barometric Pressure.

Available Values: HP (hpa)/MB (mbar)/HG (mmHg)/IC (inch), offset: -1000 to +1000

Default: Depends on the transceiver version.

Note: “**OPTION**” will be displayed if the **SU-1** is not installed.

Set Mode Item 64 [SU1.SET]

Function: Selects the display of the sensor units’ information.

Available Values: OFF/BARO/ALTI

Default: OFF

Note: The barometric pressure (BARO) and altitude (ALTI) information require the optional **SU-1**.

SET (MENU) MODE

Set Mode Item 65 [TEMP]

Function: Indicates indicate the current temperature inside the transceiver's case and selects the measurement units (“°F” or “°C”) for the temperature sensor.

Set Mode Item 66 [TN FRQ]

Function: Setting of the CTCSS Tone Frequency.

Available Values: 50 standard CTCSS tones

Default: 100.0 Hz

CTCSS TONE FREQUENCY (Hz)					
67.0	69.3	71.9	74.4	77.0	79.7
82.5	85.4	88.5	91.5	94.8	97.4
100.0	103.5	107.2	110.9	114.8	118.8
123.0	127.3	131.8	136.5	141.3	146.2
151.4	156.7	159.8	162.2	165.5	167.9
171.3	173.8	177.3	179.9	183.5	186.2
189.9	192.8	196.6	199.5	203.5	206.5
210.7	218.1	225.7	229.1	233.6	241.8
250.3	254.1	–	–	–	–

Set Mode Item 67 [TOT]

Function: Setting of the TOT time

Available Values: OFF/1MIN/3MIN/5MIN/10MIN

Default: 3MIN

The time-out timer shuts off the transmitter after continuous transmission of the programmed time.

Set Mode Item 68 [TS MUT]

Function: Enables/Disables the receiver audio output while the Tone Serch Scanner is activated.

Available Values: OFF/ON

Default: ON

Set Mode Item 69 [TS SPD]

Function: Selects the Tone Serch Scanner speed.

Available Values: FAST (2.5 tone/sec)/SLOW (1.25 tone/sec)

Default: FAST

Set Mode Item 70 [TXSAVE]

Function: Enables/Disables the Transmitter Battery Saver.

Available Values: OFF/ON

Default: OFF

Set Mode Item 71 [VFO MD]

Function: Enables or disables the VFO band edge limiting for the current band.

Available Values: BAND/ALL

Default: BAND

BAND: When the VFO frequency reaches the high band edge of the current band, the VFO frequency will jump to the low band edge of the current band (or vice versa).

ALL: When the VFO frequency reaches the high edge of the current band, the VFO frequency will jump to the low band edge of the next band (or vice versa).

Set Mode Item 72 [WAKEUP]

Function:

Available Values: OFF/5S/10S/20S/30S/EAI

Default: OFF

Set Mode Item 73 [WX ALT]

Function: Enables/Disables the Weather Alert Scan feature.

Available Values: OFF/ON

Default: OFF

SPECIFICATIONS

General

Frequency Ranges:	RX 0.5 - 1.8 MHz (BC Band), 1.8 - 30 MHz (SW Band), 30 - 76 MHz (50 MHz HAM Band), 76 - 108 MHz (FM Band), 108 - 137 MHz (Air Band), 137 - 174 MHz (144 MHz HAM Band), 174 - 222 MHz (VHF TV Band), 222 - 420 MHz (ACT 1 Band), 420 - 470 MHz (430 MHz HAM Band), 470 - 800 MHz (UHF TV Band), 803 - 998.990 MHz (ACT 2 Band)
	TX 144 - 146 MHz, 430 - 440 MHz,
Channel Steps:	5/9/10/12.5/15/20/25/50/100 kHz
Frequency Stability:	±5 ppm @ -10 °C to +50 °C
Repeater Shift:	±600 kHz (144 MHz), ±1.6/5.0/7.6 MHz (430 MHz)
Emission Type:	F2D, F3E
Antenna Impedance:	50 Ω
Supply Voltage: (Negative Ground)	Nominal: 7.4 V DC, Negative Ground Operating: 5.0 ~ 16.0 V DC (EXT DC Jack) 11.0 ~ 16.0 V DC (EXT DC Jack with Charging)
Current Consumption: (Approx. @7.4 V)	150 mA (Receive) 60 mA (Standby, Saver Off) 30 mA (Standby, Saver On) 900 μA (ON Timer Activated) 200 μA (Auto Power Off) 1.6 A (5 W TX, 144 MHz) 1.8 A (5 W TX, 430 MHz)
Operating Temperature:	-20 °C to +60 °C
Case Size:	58 (W) x 89 (H) x 28.5 (D) mm (W/O knob, antenna, and belt clip)
Weight:	270 g with FNB-80LI, and antenna

Transmitter

RF Power Output:	5.0 W (High) / 2.5 W (Low 3) / 1.0 W (Low 2) / 0.3 W (Low 1)
Modulation Type:	Variable Reactance F2D, F3E
Maximum Deviation:	±5.0 kHz (F2D, F3E)
Spurious Emission:	At least 60 dB down (@ High power)
Microphone Impedance:	2 kΩ

Receiver

Circuit Type:	AM, NFM: Double-Conversion Superheterodyne WFM: Triple-Conversion Superheterodyne		
Intermediate Frequencies:	1st	2nd	3rd
	AM, NFM: 47.25 MHz	450 kHz	–
	WFM: 45.8 MHz	10.7 MHz	1 MHz
Sensitivity :	1.5 μV for 10 dB SN (0.5-1.8 MHz, AM) 1 μV for 10 dB SN (1.8-30 MHz, AM) 0.35 μV TYP for 12 dB SINAD (30-54 MHz, NFM) 0.5 μV TYP for 12 dB SINAD (54-76 MHz, NFM) 1 μV TYP for 12 dB SINAD (76-108 MHz, WFM) 1.5 μV TYP for 10 dB SN (108-137 MHz, AM) 0.2 μV for 12 dB SINAD (137-140 MHz, FM) 0.16 μV for 12 dB SINAD (140-150 MHz, FM) 0.2 μV for 12 dB SINAD (150-174 MHz, FM) 0.5 μV TYP for 12 dB SINAD (174-250 MHz, WFM) 0.5 μV for 12 dB SINAD (300-350 MHz, NFM) 0.2 μV for 12 dB SINAD (350-420 MHz, NFM) 0.18 μV for 12 dB SINAD (420-470 MHz, NFM) 1 μV for 12 dB SINAD (470-540 MHz, WFM) 1 μV TYP for 12 dB SINAD (580-800 MHz, WFM) 0.5 μV TYP for 12 dB SINAD (800-999 MHz, NFM)		
Selectivity:	AM, NFM: 12 kHz/35 kHz (–6 dB /–60 dB) WFM: 200 kHz/500 kHz (–6 dB /–20 dB)		
AF Output:	200 mW @ 8 Ω for 10 % THD (@ 7.4 V) 400 mW @ 8 Ω for 10 % THD (@ 13.8 V)		

Specifications are subject to change without notice, and are guaranteed within the 144, 222, and 430 MHz amateur bands only. Frequency ranges will vary according to transceiver version; check with your dealer.

“AUTO” MODE PRESET OPERATING PARAMETERS

FREQUENCY RANGE (MHz)	MODE	STEP
0.500 - 1.800	AM	9 kHz
1.800 - 30.000	AM	5 kHz
30.000 - 76.000	FM	5 kHz
76.000 - 88.000	FM	5 kHz
88.000 - 108.000	WFM	100 kHz
108.000 - 137.000	AM	25 kHz
137.000 - 160.600	FM	12.5 kHz
160.600 - 162.025	FM	25 kHz
162.025 - 174.000	FM	12.5 kHz

FREQUENCY RANGE (MHz)	MODE	STEP
174.000 - 222.000	WFM	50 kHz
222.000 - 300.000	FM	12.5 kHz
300.000 - 320.000	AM	25 kHz
320.000 - 420.000	FM	12.5 kHz
420.000 - 430.000	FM	12.5 kHz
430.000 - 440.000	FM	25 kHz
440.000 - 470.000	FM	12.5 kHz
470.000 - 800.000	WFM	50 kHz
800.000 - 999.000	FM	12.5 kHz

INSTALLATION OF THE **SU-1** (OPTION)

1. Make sure that the transceiver is off. Remove the hard or soft case, if used.
2. Remove the battery pack.
3. Locate the connector for the **SU-1** under the caution seal in the battery compartment on the back of the radio, just peel off the caution seal.
4. Align the connector on the **SU-1** with the transceiver's connector and gently press the unit into place.
5. Affix the new (supplied) caution seal, and replace the battery.
6. Installation is now complete.

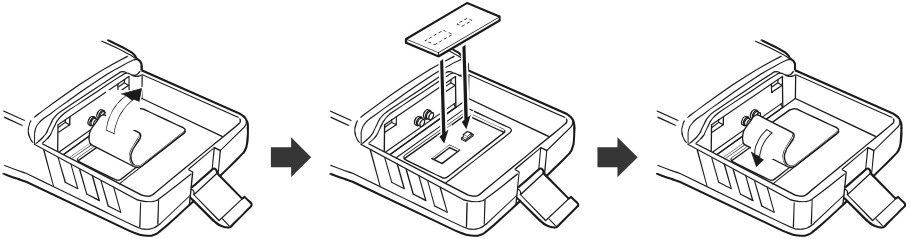

Important note

The Barometric Pressure/Altitude features of the optional **SU-1** are designed to be supplemental aids for the information of the user, and are not intended to be a substitute for accurate, calibrated Barometer or Altimeter devices used for navigation critical to personal safety.

NOTE



Copyright 2005
VERTEX STANDARD CO., LTD.
All rights reserved.

No portion of this manual
may be reproduced
without the permission of
VERTEX STANDARD CO., LTD.

Printed in Japan



E H 0 2 1 M 2 0 0

0505H-0M