

SINEWAVE INVERTER-CHARGER



SAMLEX EUROPE[®] B.V.

Sinewave inverter-charger Heavy Duty

Model No.

XTS 900-12	XTM 1500-12	XTH 3000-12
XTS 1200-24	XTM 2000-12	XTH 5000-24
XTS 1400-48	XTM 2400-24	XTH 6000-48
	XTM 2600-48	XTH 8000-48
	XTM 3500-24	
	XTM 4000-48	

User Manual

Please read this manual before operating your inverter-charger

SUMMARY

1	INTRODUCTION.....	5
2	GENERAL INFORMATION	5
2.1	Operating instructions	5
2.2	Conventions	6
2.3	Quality and warranty.....	6
2.3.1	Exclusion of warranty.....	6
2.3.2	Exclusion of liability.....	7
2.4	Warnings and notes	7
2.4.1	General	7
2.4.2	Precautions for using the batteries	7
3	ASSEMBLY AND INSTALLATION	8
3.1	Handling and moving.....	8
3.2	Storage	8
3.3	Unpacking.....	8
3.4	Installation site	8
3.5	Fastening	9
3.5.1	Fastening XTH model.....	9
3.5.2	Fastening XTM model	9
3.5.3	Fastening XTS model.....	9
3.6	Connections	10
3.6.1	General recommendations	10
3.6.2	Device connection compartment XTH - XTM.....	11
3.6.3	Device connection compartment XTS	12
3.6.4	Elements of connection cabinet	13
4	CABLING	14
4.1	Choice of system	14
4.1.1	Hybrid type stand-alone systems	14
4.1.2	Grid-connected emergency systems	14
4.1.3	Integrated mobile systems	14
4.1.4	Multi-unit systems.....	15
4.1.5	Distributed Minigrid:	15
4.2	Earthing system	15
4.2.1	Mobile installation or installation connected to the grid via plug connector	15
4.2.2	Stationary installation	16
4.2.3	Installation with automatic PE-neutral switching	16
4.2.4	4.2.4 Lightning protection.....	16
4.3	Recommendations for dimensioning the system	16
4.3.1	Dimensioning the battery	16
4.3.2	Dimensioning the inverter.....	17
4.3.3	Dimensioning the generator	17
4.3.4	Dimensioning the renewable energy sources.....	17
4.4	Wiring diagrams	17
4.5	Connecting the battery	17
4.5.1	Battery cable cross-section and DC protective devices.....	18
4.5.2	Connecting the battery (Xtender side).....	18
4.5.3	Fuse mounting on battery positive pole (XTM only)	19
4.5.4	Battery-side connection	19
4.5.5	Earthing the battery	20
4.5.6	Connecting the consumers at the AC output	20
4.5.7	Connecting the AC supply sources	21
4.5.8	Wiring auxiliary contacts.....	21
4.5.9	Connecting the communications cables.....	21
5	XTENDER PARAMETER SETTING	22
5.1	Basic parameter setting in the XTS	22
6	POWERING UP THE INSTALLATION.....	22
7	DESCRIPTION OF THE MAIN FUNCTIONS	24
7.1	Inverter.....	24
7.1.1	Automatic load detection (load search)	24

7.2	Transfer relay.....	24
7.2.1	Type of detection of AC input loss (UPS)	24
7.2.2	Limiting the AC input current "Input limit"	25
7.3	Battery charger	26
7.3.1	Working principle:	26
7.3.2	Battery charger current setting:	28
7.3.3	Battery protection.....	28
7.4	Xtender protection.....	28
7.5	Auxiliary contacts	29
7.6	The real time clock.....	29
7.7	Entry command (Remote control on/off)	29
8	MULTI-UNIT CONFIGURATION	30
8.1.1	Three-phase system	31
8.1.2	Increasing the power by paralleling units	31
8.1.3	Combined system	31
8.1.4	Enlargement of an existing installation	31
9	ACCESSORIES.....	32
9.1	Control centre and display RCC-02/-03 (remote control)	32
9.2	BTS-01 temperature sensor.....	33
9.2.1	Connecting the temperature sensor (BTS-01)	33
9.3	Remote control Module RCM-10 (XTM/XTS).....	33
9.3.1	Connection of the RCM-10 module.....	33
9.4	Time and communication module TCM-01 (XTS)	34
9.5	Auxiliary Relay Module ARM-02 (XTS)	34
9.6	External Cooling Fan unit ECF-01 (XTS)	34
10	OTHER DEVICES COMPATIBLE XTENDER SYSTEMS.....	34
10.1	BATTERY STATUS PROCESSORS BSP- 500/1200	34
10.2	COMMUNICATION MODULE XCOM-232I	34
11	CONTROL.....	35
11.1	Main on/off control	35
11.2	Display and control panel	35
12	MAINTENANCE OF THE INSTALLATION	37
13	PRODUCT RECYCLING	37
14	EC DECLARATION OF CONFORMITY	37
15	COMMENTS OF APPENDIX DRAWINGS	38
16	DRAWING'S ELEMENTS (DC SIDE).....	40
17	FIGURE ELEMENT'S (AC PART).....	40
18	MECHANICAL DIMENSION AND MOUNTING ELEMENT.....	42
19	NAMEPLATE (FIG. 1B).....	42
20	TABLE OF FACTORY'S (DEFAULTS) PARAMETERS SETTINGS.....	43
21	TECHNICAL DATA	45
22	NOTES.....	46

1 INTRODUCTION

Congratulations! You are about to install and use a device from the Xtender range. You have chosen a high-tech device that will play a central role in energy saving for your electrical installation. The Xtender has been designed to work as an inverter / charger with advanced functions, which can be used in a completely modular way and guarantee the faultless functioning of your energy system.

When the Xtender is connected to a generator or network, the latter directly supplies the consumers, and the Xtender works like a battery charger and backup device if necessary. The powerful battery charger has an exceptional high efficiency and power factor correction (PFC) close to 1. It guarantees excellent battery charging in all situations. The charge profile is freely configurable according to the type of battery used or the method of usage. The charge voltage is corrected depending on the temperature, thanks to the optional external sensor. The power of the charger is modulated in real time dependent according to the demand of the equipment connected at the Xtender output and the power of the energy source (network or generator). It can even temporarily backup the source if the consumer demand exceeds the source capacity.

The Xtender continuously monitors the source to which it is connected (network or generator) and disconnects itself immediately if the source is missing, disturbed or does not correspond to the quality criteria (voltage, frequency, etc.). It will then function in independent mode, thanks to the integrated inverter. This inverter, which has an extremely robust design, benefits from Samlex's many years of experience and expertise in this area. It could supply any type of load without faults, enjoying reserves of additional power that is unmatched on the market. All your equipment will be perfectly provided with energy and protected from power outages in systems where energy supply is unpredictable (unreliable network) or voluntarily limited or interrupted, such as hybrid installations on remote sites or mobile installations.

The parallel and/or three-phase network operation of the Xtender offers modularity and flexibility and enables optimum adaptation of your system to your energy requirements.

The RCC-02/-03 control, display and programming centre (optional) enables optimum parametering of the system and guarantees the operator continuous control for all important parameters in the installation.

In order to guarantee perfect commissioning and functioning of your installation, please read this manual carefully. It contains all the necessary information relating to the functioning of the inverters / chargers in the Xtender series. The setting up of such a system requires special expertise and may only be carried out by qualified personnel familiar with the applicable local regulations.

2 GENERAL INFORMATION

2.1 OPERATING INSTRUCTIONS

This manual is an integral part of each inverter/charger from the Xtender series.

It covers the following models and accessories¹:

Inverter/charger:

XTH 3000-12 – XTH 5000-24 – XTH 6000-48 – XTH 8000-48

XTM 1500-12, XTM 2000-12, XTM 2400-24,

XTM 3500-24, XTM 2600-48, XTM 4000-48

XTS 900-12, XTS 1200-24, XTS 1400-48

External cooling fan: ECF-01

Temperature sensor: BTS-01

Remote command module: RCM-10

Auxiliary relay module: ARM-02



For greater clarity, the device is referred to in this manual as Xtender, unit or device, when the description of its functioning applies indiscriminately to different Xtender models.

These operating instructions serve as a guideline for the safe and efficient usage of the Xtender. Anyone who installs or uses an Xtender can rely completely on these operating instructions, and is bound to observe all the safety instructions and indications contained. The installation and commissioning of the Xtender must be entrusted to a qualified professional. The installation and

¹ Also for 120Vac model (-01)

usage must conform to the local safety instructions and applicable standards in the country concerned.

2.2 CONVENTIONS

	This symbol is used to indicate the presence of a dangerous voltage that is sufficient to constitute a risk of electric shock.
	This symbol is used to indicate a risk of material damage.
	This symbol is used to indicate information that is important or which serves to optimise your system.

All values mentioned hereafter, followed by a parameter number indicate that this value may be modified using the RCC-02/-03 remote control.

In general, the default values are not mentioned and are replaced by a parameter number in the following format: {xxxx}. The default values for this parameter are specified in the defaults parameter table, p.43.

	All parameter values modified by the operator or installer must be transferred into the same table. If a parameter not appearing in the list (advanced parameters) has been modified by an authorised person with technical knowledge, they will indicate the number of the modified parameter(s), the specifications of the parameter(s) and the new value set, at the end of the same table.
---	--

All figures and letters indicated in brackets or in square brackets refer to items that can be found in the separate manual "Appendix to the installation and operating instructions" supplied with the device. In this appendix, these figures and letters are encircled.

- The **figures** in brackets refer to elements belonging to the **Xtender**.
- The **uppercase letters** in brackets refer to **AC** cabling elements.
- The **lowercase letters** in brackets refer to **battery** cabling elements.
- The comments on figures and items of figures of the appendix are given p. 40 and following.

2.3 QUALITY AND WARRANTY

During the production and assembly of the Xtender, each unit undergoes several checks and tests. These are carried out with strict adherence to the established procedures. Each Xtender has a serial number allowing complete follow-up on the checks, according to the particular data for each device. For this reason it is very important never to remove the type plate (appendix 1 – fig. 3b) which shows the serial number. The manufacture, assembly and tests for each Xtender are carried out in their entirety by our factory in Sion (CH). The warranty for this equipment depends upon the strict application of the instructions appearing in this manual.

2.3.1 Exclusion of warranty

No warranty claims will be accepted for damage resulting from handling, usage or processing that does not explicitly appear in this manual. Cases of damage arising from the following causes are notably excluded from the warranty:

- Surge voltage on the battery input (for example, 48 V on the battery input of an XTH 3000-12)
- Incorrect polarity of the battery
- The accidental ingress of liquids into the device or oxidation resulting from condensation
- Damage resulting from falls or mechanical shocks
- Modifications carried out without the explicit authorisation of Samlex Europe
- Nuts or screws that have not been tightened sufficiently during the installation or maintenance
- Damage due to atmospheric surge voltage (lightning)
- Damage due to inappropriate transportation or packaging
- Disappearance of original marking elements

2.3.2 Exclusion of liability

The placement, commissioning, use, maintenance and servicing of the Xtender cannot be the subject of monitoring by Samlex Europe. For this reasons we assume no responsibility and liability for damage, costs or losses resulting from an installation that does not conform to the instructions, defective functioning or deficient maintenance. The use of a Samlex inverter is the responsibility of the customer in all cases.

Samlex Europe shall in no event be liable for consequential, incidental, contingent or special damages, even if having been advised of the probability of such damages. This equipment is neither designed nor guaranteed to supply installations used for vital medical care nor any other critical installation carrying significant potential damage risks to people or the environment.

Samlex Europe assume no responsibility for the infringement of patent rights or other rights of third parties that result from using the inverter.

Samlex Europe reserves the right to make any modifications to the product without prior notification.

2.4 WARNINGS AND NOTES

2.4.1 General

	This manual is an integral part of the device and must be kept available for the operator and installer. It must remain close to the installation so that it may be consulted at any time.
---	--

The parameter table available at the end of the manual (p.43) must be kept up to date in the event of modification of the parameters by the operator or installer. The person in charge of installation and commissioning must be wholly familiar with the precautionary measures and the local applicable regulations.

	<p>When the Xtender is running, it generates voltage that can be potentially lethal. Work on or close to the installation must only be carried out by thoroughly trained and qualified personnel. Do not attempt to carry out ongoing maintenance of this product yourself. The Xtender or the generator connected to it may start up automatically under certain predetermined conditions.</p> <p>When working on the electrical installation, it is important to be certain that the source of DC voltage coming from the battery as well as the source of AC voltage coming from a generator or network have been disconnected from the electrical installation.</p> <p>Even when the Xtender has been disconnected from the supply sources (AC and DC), a dangerous voltage may remain at the outputs. To eliminate this risk you must switch the Xtender OFF using the ON/OFF button (1). After 10 seconds the electronics is discharged and intervention may take place without any danger.</p>
---	---

All elements connected to the Xtender must comply with the applicable laws and regulations. Persons not holding written authorisation from Samlex Europe are not permitted to proceed with any change, modification or repairs that may be required. Only original parts may be used for authorised modifications or replacements.

This manual contains important safety information. Read the safety and working instructions carefully before using the Xtender. Adhere to all the warnings given on the device as well as in the manual, by following all the instructions with regard to operation and use.

The Xtender except XTS, is only designed for indoor use and must under no circumstances be subjected to rain, snow or other humid or dusty conditions. The maximum specifications of the device shown on the type plate, as at fig. 1b, must be adhered to.

In the event of use in motorised vehicles, the Xtender must be protected from dust, splash water and any other humid condition. It must also be protected from vibration by installing absorbent parts.

2.4.2 Precautions for using the batteries



Lead-acid or gel batteries produce a highly explosive gas with normal use. No source of sparks or fire should be present in the immediate vicinity of the batteries. The batteries must be kept in a well-ventilated place and be installed in such a way as to avoid accidental short-circuits when connecting.

Never try to charge frozen batteries.

When working with the batteries, a second person must be present in order to lend assistance in the event of problems.

Sufficient fresh water and soap must be kept to hand to allow adequate and immediate washing of the skin or eyes affected by accidental contact with the acid.

In the event of accidental contact of the eyes with acid, they must be washed carefully with cold water for 15 minutes. Then immediately consult a doctor.

Battery acid can be neutralised with baking soda. A sufficient quantity of baking soda must be available for this purpose.

Particular care is required when working close to the batteries with metal tools. Tools such as screwdrivers, open-ended spanners, etc. may cause short-circuits. Consequently occurring sparks may cause the battery to explode.

When working with the batteries, all metal jewellery such as rings, bracelet watches, earrings, etc., must be taken off. The current output by the batteries during short-circuit is sufficiently powerful to melt the metal and cause severe burns.

In all cases, the instructions of the battery manufacturer must be followed carefully.

3 ASSEMBLY AND INSTALLATION

3.1 HANDLING AND MOVING

The weight of the Xtender is can be up to 50kg depending upon the model. Use an appropriate lifting method as well as help from a third party when installing the equipment.

3.2 STORAGE

The equipment must be stored in a dry environment at an ambient temperature of between -20°C and 60°C. It stays in the location where it is to be used a minimum of 24 hours before being set up.

3.3 UNPACKING

When unpacking, check that the equipment has not been damaged during transportation and that all accessories listed below are present. Any fault must be indicated immediately to the product distributor or the contact given at the back of this manual.

Check the packaging and the Xtender carefully.

Standard accessories:

Installation and operating instructions, c.f. Appendix 1

Mounting plate for XTH and XTS– fig. 2a (25)(26)

One set of cable glands on the unit and/or apart.

Four M6 screws and washer for XTS to assemble the support and the enclosure.

3.4 INSTALLATION SITE

The installation site for the Xtender is of particular importance. XTH and XTM range are designed to indoor use (IP20) and the place of installation must satisfy the following criteria:

- Protected from any unauthorised person.
- Protected from water and dust and in a place with no condensation.
- It must not be situated directly above the battery or in a cabinet with it.
- No easily inflammable material should be placed directly underneath or close to the Xtender.
- Ventilation apertures must always remain clear and be at least 20cm from any obstacle that may affect the ventilation of the equipment.
- In mobile applications it is important to select an installation site that ensures as low a vibration level as possible.

XTS range appliances have a higher grade of protection (IP54).and can be installed outdoor, dust exposed environment or water splash. Care must be taken to not expose the unit under direct sun irradiation or near to a heat source (i.e. engine compartment). The presence of a heat source may reduce significantly the nominal power of the unit.

Reduce as much as possible exposure to great temperature variation: large heat variation may induce condensation drop inside the appliance.

3.5 FASTENING

	<p>The Xtender is a heavy unit and must be mounted to a non flammable support (wall) designed to bear such a load</p>
---	---

The Xtender must be installed vertically onto heavy duty material (concrete or metallic wall) and positioned vertically with cable glands oriented down. A sufficient space around it must be provided to guarantee adequate ventilation of the device (see figs. 2a).

3.5.1 Fastening XTH model

Firstly fix the mounting bracket (26) supplied with the device using 2 Ø < 6-8 mm > screws**. Then hang the Xtender on the bracket. Fasten the unit permanently using 2 Ø < 6-8 mm > screws** on to the two notches located at the underside of the case. Dimension of the appliances are given on Fig 2a of the appendix

3.5.2 Fastening XTM model

Screw first the top screw (6-8mm **) without washer on a solid wall (concrete or metallic wall) up to a distance of 2mm between head and wall. Hang the apparatus by taking care to release beforehand the trap door of access (27 fig 2a of the appendix) by inserting it inside the apparatus using a screwdriver, if you estimate that a complete tightening of this point of fixing is necessary. In theory complete tightening is necessary only in the mobile installations.

Dismount the lower plastic cap of the apparatus giving access to the compartment of wiring. Carefully fix the apparatus with two screws (Ø 6-8 mm) in the two clamp holes down inside the compartment of wiring.

If the Xtender is installed in a closed cabinet this must have sufficient ventilation to guarantee an ambient temperature that conforms to the operation of the Xtender.

** : These items are not delivered with the device.

	<p>It is imperative to ensure complete and safe fastening of the device. A device that is simply hung may detach and cause severe damage.</p>
---	---

3.5.3 Fastening XTS model

The XTS enclosure must be first mounted on the support plate with the 4 screws and washer delivered with the appliance according with figure aside. Then the unit can be fixed on a heavy duty support (concrete or metallic wall) and positioned vertically with cable glands oriented down. An external ventilation unit (ECF-01 p.34) can be installed on top of the unit before or after wall mounting.

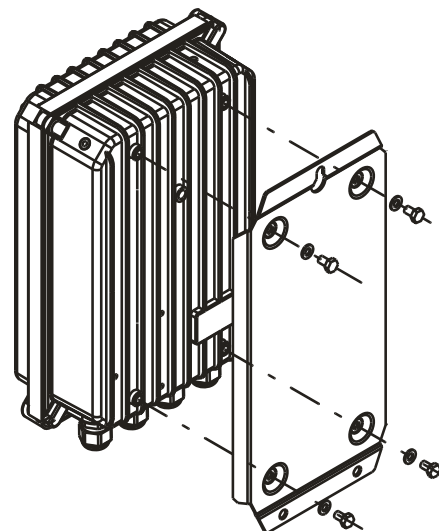

	<p>The envelope of the XTS can reach temperature higher than 60°C when used for a long period at the maximum of its performances. These high temperatures may remain present during several tens of minutes after stopping the unit. It's recommended to choose a place of installation in a restricted access area, away from children or any unauthorized person.</p>
---	--

3.6 CONNECTIONS

3.6.1 General recommendations

The Xtender falls within protection class I (has a PE connection terminal). It is vital that a protective earth is connected to the AC IN and/or AC OUT PE terminals. An additional protective earth is located at the bottom of the unit (See sect.0 – p. 11 tag(17)).



In all cases, the PE conductor for the equipment must at least be connected to the PE for all equipment in protection class I upstream and downstream of the Xtender (equipotential bonding). It is mandatory that the legislation in force for the application concerned be adhered to.

Tighten of the input (13) and output (14) terminals by means of a no. 3 screwdriver and those for the "Command entry (REMOTE ON/OFF)" (7) and "AUX.CONTAC" (8) by means of a no. 1 screwdriver.

The cable cross-sections of these terminals must conform to local regulations.

All connection cables as well as the battery cables must be mounted using cable restraints in order to avoid any traction on the connection.

Battery cables must also be as short as possible and the cross-section must conform with the applicable regulations and standards. Sufficiently tighten the clamps on the "battery" inputs (fig. 4a (11) and (12)).

3.6.2 Device connection compartment XTH - XTM



The unit's connection compartment must remain permanently closed when in operation. It is imperative to close the protection cap on the connection terminals after each intervention in the device.

After opening, check that all sources of AC and DC voltage (batteries) have been disconnected or put out of service.

Some accessible part inside the compartment can have surface temperature higher than 60°C. Wait for the complete cooling of the unit before opening the compartment.

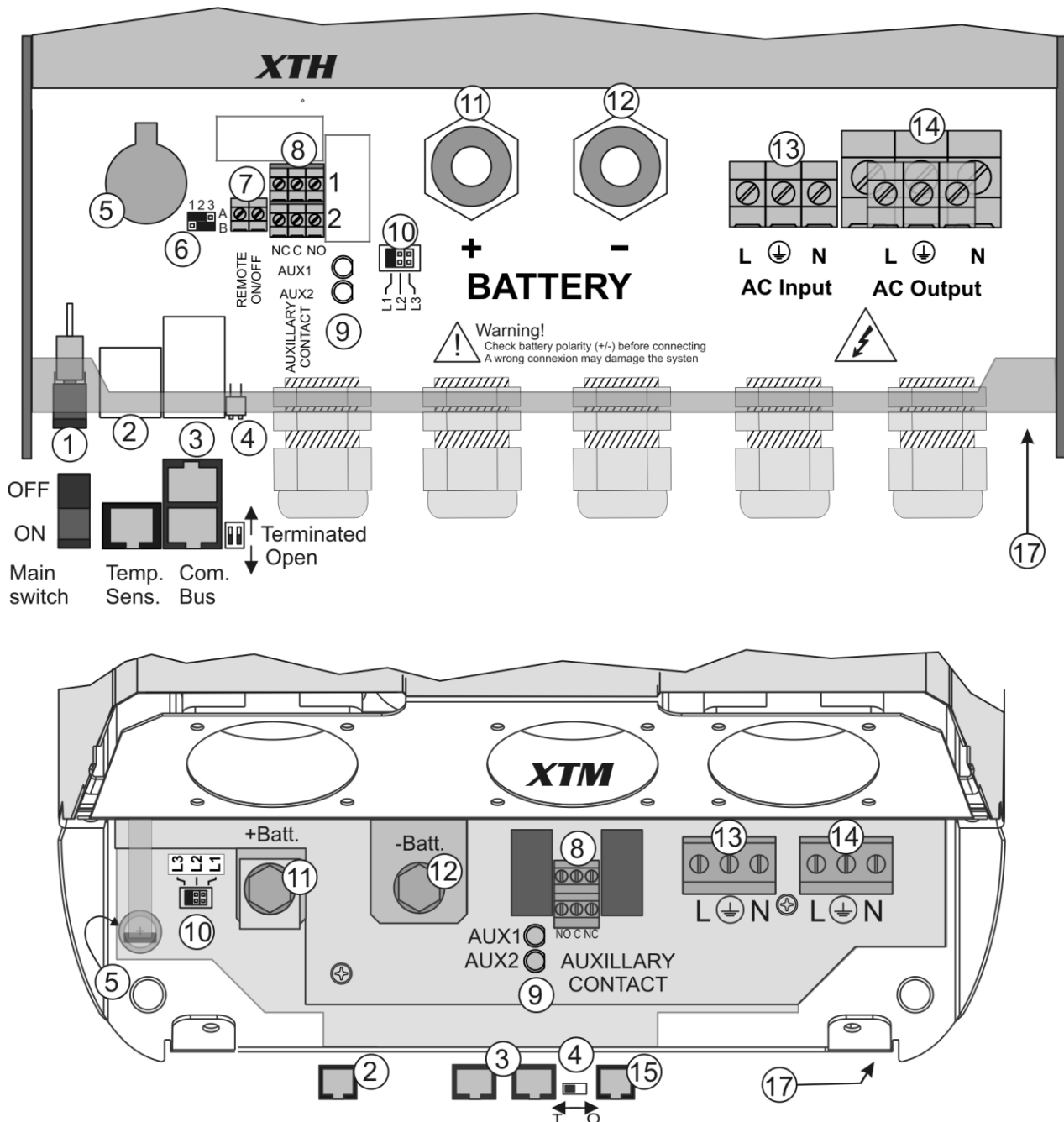



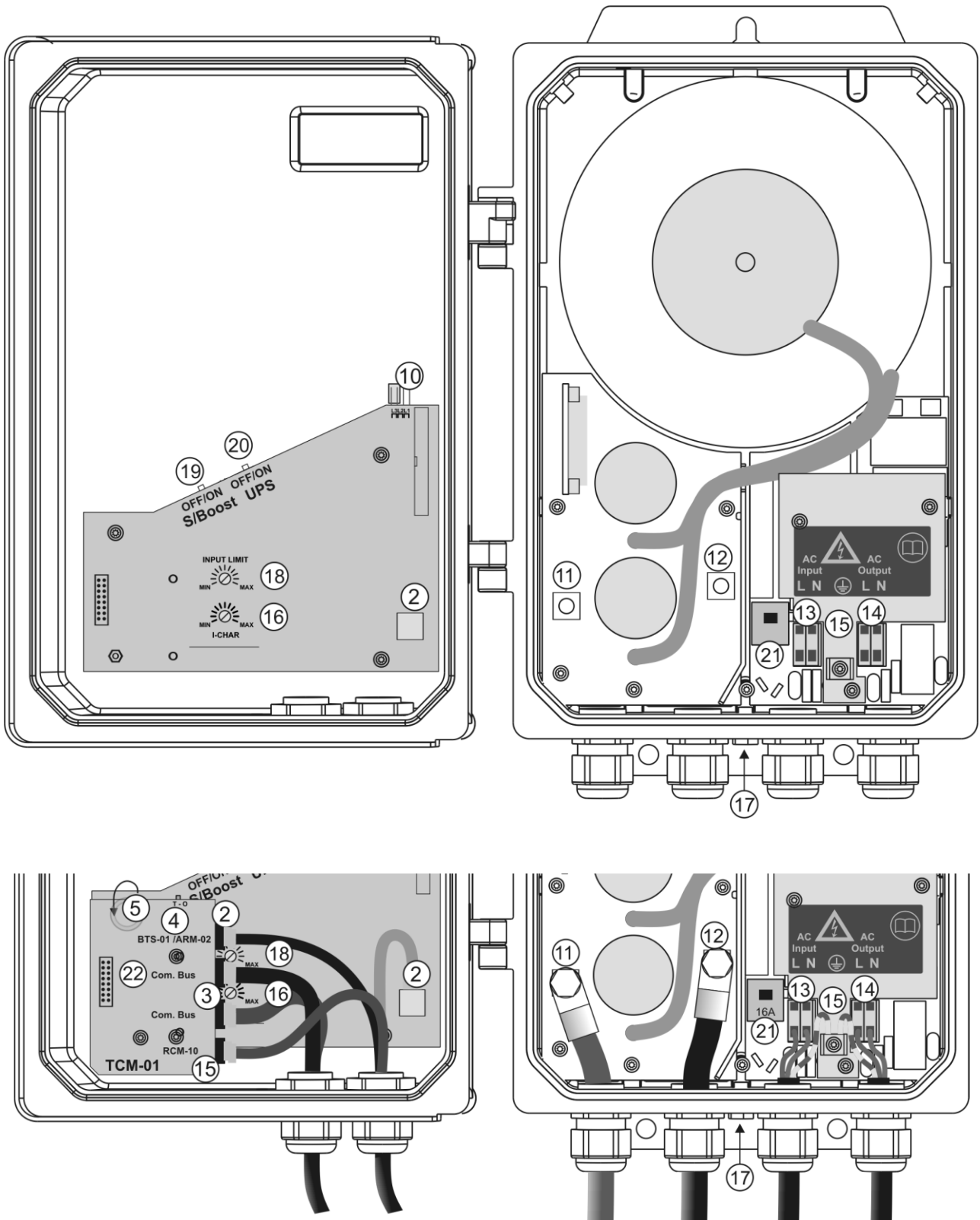

Any unused cable entry on the device must be sealed so as to prevent any intrusion. An intrusion of small animals in the unit may cause serious damage not covered by warranty

3.6.3 Device connection compartment XTS



 Any unused cable entry on the device must be sealed so as to prevent any intrusion. An intrusion of small animals in the unit may cause serious damage not covered by warranty

3.6.4 Elements of connection cabinet

Pos.	Denomination	Description	Comment
1	ON/OFF Main switch	Main on/off switch	See sect. 11.1 - p 35. In XTM and XTS series, this function is deported on the remote command module RCM-10. See sect.9.3 – p.33
2	Temp. Sens	Connector for the battery temperature sensor	See sect. 9.2 – p. 33. Only connect the original Samlex BTS-01 sensor
3	Com. Bus	Double connector for connecting peripherals such as the RCC-02/03 or other Xtender units	For the XTS model, these connectors are available only if the module TCM-01 (see sect. 9.4 – p. 34) is implemented.
4	O / T (Open / Terminated)	Switch for terminating the communication bus. Set position (open) if the 2 connectors (3) are occupied. Set position T if only one is occupied.	On model XTH the 2 termination switches (4) must be in the same position: Or the 2 in position O (open) or the 2 in position T (terminated)
5	--	3.3 V (CR-2032) lithium ion type battery socket	Used as a permanent supply for the internal clock. See sect. 7.6 - p.29
6	--	Jumper for programming the off/on switch by dry contact	See sect. 7.7 – p. 29 and fig. 8b point (6) and (7). They are positioned at A-1/2 and B-2/3 by default
7	Command entry (REMOTE ON/OFF)	Entry command terminals.. In XTM series, this entry is deported on the remote command module RCM-10. See sect. 9.3 – p. 33	Allow to give a function – to be defined by programming – by the closing of a dry contact or by the presence of a voltage across these terminals. See sect. 7.7 – p. 29).
8	AUXILLARY CONTACT	Auxiliary contact For XTS model, available only with module ARM-02 (see sect. 9.5 - p. 34)	(See sect. 7.5 – p. 29) Take care not to exceed the admissible loads
9	--	Activation indicators for auxiliary contacts 1 and 2	See sect. 7.5 – p. 29
10	L1/L2/L3	Phase selection jumpers.	See sect. 8.1.1. – p.31. Jumper default at position L1
11	+BAT	Positive pole battery connection terminals	Carefully read sect. 4.5 – p.17 Take care with the polarity of the battery and when tightening the clamp.
12	-BAT	Negative pole battery connection terminals	
13	AC Input	Connection terminals for the alternative power supply (generator or public network)	See sect. 4.5.7 - p. 21. Note: It is imperative that the PE terminal be connected.
14	AC Output	Connection terminals for the device output.	See sect. 4.5.6 - p. 21. Note: Increased voltages may appear on the terminals, even in the absence of voltage at the input of the inverter.
15	RCM-10	Connector for RCM-10 module	Only on XTM. See sect. 9.3 – p.33
16	I-CHAR	Rotating knob to adjust the battery charge current	Only in XTS model.
17		Connection for supplementary protective earth.	This connection can also be used as principal protective earth.
18	INPUT LIMIT	Rotating knob to adjust the input current limit	Only in XTS model.

19	OFF/ON S/Boost	Activation of source assistance "Smart boost" function	Only in XTS model.
20	OFF/ON UPS	Setting of sensitivity of the detection of AC input loss: OFF=tolerant / ON=Fast	Only in XTS model.
21	16A	AC input protective device: Only on XTS model. This protective device will trip in case of excessive load when the XTS is connected to an unprotected source higher than 16A. It can be reset after removing the default downstream (load too high) and upstream (source greater than 16A. (check the unit is connected thru an upstream protective device (fuse or circuit breaker) max. 16 A	
22	--	Insertion holes for TCM-01 optional communication module (see sect. 9.3.1- p.33	

4 CABLING

The connection of the Xtender inverter / charger is an important installation step.

It may only be carried out by qualified personnel and in accordance with the applicable local regulations and standards. The installation must always comply with these standards.

Pay attention that connections are completely tightened and that each wire is connected at the right place.

4.1 CHOICE OF SYSTEM

The Xtender may be used in different system types, each of which must meet the standards and particular requirements associated with the application or site of installation. Only an appropriately qualified installer can advise you effectively on the applicable standards with regard to the various systems and the country concerned.

Examples of cabling are presented in appendix I of this manual, fig. 5 and following. Please carefully read the notes associated with these examples in the tables on p. 33 and following.

4.1.1 Hybrid type stand-alone systems

The Xtender can be used as a primary supply system for off- grid sites where a renewable energy source (solar or hydraulic) is generally available and a generator is used as backup. In this case, batteries are generally recharged by a supply source such as solar modules, wind power or small hydropower systems. These supply sources must have their own voltage and/or current regulation system and are connected directly to the battery. (Example, fig. 11)

When the energy supply is insufficient, a generator is used as a back-up energy source. This allows the batteries to be recharged and direct supply to consumers via the Xtender transfer relay.

4.1.2 Grid-connected emergency systems

The Xtender can be used as an emergency system, also known as an uninterruptible power supply (UPS) – enabling a reliable supply to a site connected to an unreliable network. In the event of an interruption to the energy supply from the public network, the Xtender, connected to a battery, substitutes the faulty source and enables a support supply to the users connected downstream. These will be supplied as long as the energy stored in the battery allows. The battery will quickly be recharged at the next reconnection to the public grid.

Various application examples are described in figs. 8a – 8c in appendix 1.

	<p>The use of the Xtender as a UPS must be carried out by qualified personnel who have been checked by the responsible local authorities. The diagrams in the appendix are given for information and as a supplement. The applicable local standards and regulations must be adhered to.</p>
---	--

4.1.3 Integrated mobile systems

These systems are meant to be temporarily connected to the grid and ensure the supply of the mobile system when this is disconnected from the grid. The main applications are for boats, service vehicles and leisure vehicles. In these cases, two separate AC inputs are often required, one

connected to the grid and the other connected to an on-board generator. Switching between two sources must be carried out using an automatic or manual reversing switch, conforming to the applicable local regulations. The Xtender has a single AC input. Various application examples are described in figs. 10a – 10b – 10c.

4.1.4 Multi-unit systems

Whatever system is selected, it is possible to realise systems composed of several units of the same type and the same power output. Up to three Xtenders in parallel or three extenders forming a three-phase grid or three times two or three Xtenders in parallel forming a three-phase / parallel grid, may be thus combined.

4.1.5 Distributed Minigrid:

The implementation of the Xtender on top of a distributed minigrid (beyond the main building) requires special care in choosing the distribution system.

Samlex Europe recommends a TT distribution for the DC grid as well as for the AC grid.

	The size of the grid increases greatly the exposure of the inverters to atmospheric overvoltages and to non equipotentiality in the grid. This is particularly noticeable in the aerial distribution grids. In this case a very special care must be taken to well implementing all protection measures of the installation.
---	--

	The IT system is not recommended for the distribution. This kind of distribution is most of the time forbidden by the local laws. The achievement of low voltage electric system is <u>always</u> subject to local laws and must imperatively be implemented and controlled by qualified and professionally authorized staff. Samlex Europe accepts no liability for damages due to non confirming installation and to the lack of compliance with the local rules or with the recommendations of this manual.
--	--

4.2 EARTHING SYSTEM

The Xtender is a protection class I unit, which is intended for cabling in a grid type TT, TN-S or TNC-S. The earthing of the neutral conductor (E) is carried out at a sole installation point, upstream of the RCD circuit breaker (D).

The Xtender can be operated with any earthing system. In all cases it is imperative that the protective earth be connected in compliance with the applicable standards and regulations. The information, notes, recommendations and diagram mentioned in this manual are subject to local installation regulations in every case. The installer is responsible for the conformity of the installation with the applicable local standards.

4.2.1 Mobile installation or installation connected to the grid via plug connector

When the input of the device is connected directly to the grid via a plug, the length of the cable must not exceed 2 m and the plug must remain accessible.

In the absence of voltage at the input, the neutral and live are interrupted, thereby guaranteeing complete isolation and protection of the cabling upstream of the Xtender.

The earthing system downstream of the Xtender is determined by the upstream earthing system when the grid is present. In the absence of the grid, the earthing system downstream of the inverter is in isolated mode. The safety of the installation is guaranteed by the equipotential bonding.

	The connection (link) between the neutrals (C) upstream and downstream of the Xtender is not permitted in this configuration.
---	---

This connection type guarantees the optimal continuity for supplying the Xtender loads. The first isolation fault will not lead to an interruption in the supply.

If the installation requires the use of a permanent isolation controller this would have to be de-activated when the TT network is present at the Xtender input.



4.2.2 Stationary installation

The installation may be equivalent to a mobile installation (with interrupted neutral).

In a fixed installation where the neutral is connected to the earth at a single installation point upstream of the Xtender, it is permissible to carry out a connection of the neutrals in order to preserve an unchanged earthing system downstream, independent of the operating mode of the Xtender. This choice has the advantage of keeping the protection devices downstream of the Xtender. This connection can be executed according to the examples in appendix 1, or carried out by modifying the parameter {1486}

In this case the appearance of the first fault will lead to the installation stopping or the disconnection of the protection devices upstream and/or downstream of the Xtender.

Safety is guaranteed by the equipotential bonding and by any RCD circuit-breakers placed downstream.

This connection (C) is not permitted if a socket is installed upstream of the Xtender.

4.2.3 Installation with automatic PE-neutral switching

In certain applications, it is desirable to keep the neutral upstream and downstream of the Xtender separated (C) while re-establishing the earthing system (TN-S, TT or TNC-S) in the absence of voltage at the input. This functionality is forbidden by default by the parameter {1485}. This parameter can be modified by the parameter {1485} via the RCC-02/-03 remote control. This modification must be carried out possessing technical knowledge, at the responsibility of the installer and in conformity with the applicable regulations and standards.

The authorization of this function adherence to the requirements for an earth-neutral connection at the source.

4.2.4 4.2.4 Lightning protection

As per the installation site, it is highly recommended to set a protection strategy to protect your installation against lightning. The strategies depend on various parameters directly linked to each site and we recommend therefore to deal very professionally with this issue.

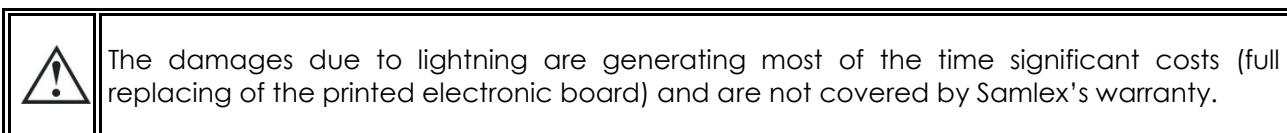

4.3 RECOMMENDATIONS FOR DIMENSIONING THE SYSTEM

4.3.1 Dimensioning the battery

The battery capacity is dimensioned according to the requirements of the user – that is 5 to 10 times its average daily consumption. The discharge depth of the battery will therefore be limited and the service life of the battery will be extended.

On the other hand, the Xtender must have a battery capacity that is large enough to be able to take full advantage of the performance of the equipment. The minimum capacity of the batteries (expressed in Ah) is generally dimensioned in the following way: five times the rated power output of the Xtender / the battery voltage. For example, the model XTH 8048 must have a battery of a minimum capacity of $7000 \cdot 5 / 48 = 730$ Ah (C 10). Because of the inverter's extreme overload capacity, it is often recommended that this value be rounded up. An under-dimensioned battery may lead to an accidental and undesired stopping of the Xtender in the event of high instances of use. This stoppage will be due to a voltage that is insufficient on the battery, subject to a strong discharge current.

The battery will be selected with regard to the greatest value resulting from the calculations set out above.

The battery capacity determines the adjustment of the parameter {1137} "battery charge current".

A value between 0.1 and 0.2 x C batt. [Ah] (C10) enables an optimum charge to be guaranteed.

	<p>The method proposed below is strictly indicative and in no way constitutes a guarantee of perfect dimensioning. The installer is solely responsible for good dimensioning and installation</p>
---	---

4.3.2 Dimensioning the inverter

The inverter is dimensioned in such a way that the rated power output covers the power of all the consumers which will be used at the same time. A dimensioning margin of 20 to 30% is recommended to guarantee that the Xtender will work well in an ambient temperature of more than 25 °C.

4.3.3 Dimensioning the generator

The power output of the generator must be the same or more than the average daily power. Optimally, it should be two or three times this power. Thanks to the input limit function (see sect. 7.2.2 p.25) it is not necessary to over-dimension the generator. Indeed, the loads those are temporarily higher than the power of the generator will be supplied by the inverter. Ideally the generator should not have a power output by phase that is less than half of the power of the Xtender(s) present at this phase.

	<p>The power available downstream of the inverter when the generator is working is the same as the sum of the two powers if the Smart Boost function is activated. The sum of the currents is limited to a maximum of 57A (80A for the models XTH 8000-48, XTH 6000-48-01, and XTH 5000-24-01). This sum is limited to 20A in XTS model</p>
---	---

4.3.4 Dimensioning the renewable energy sources

In a hybrid system, the alternative energy sources such as the solar generator, wind power and small hydropower should, in principle, be dimensioned in such a way as to be able to cover the average daily consumption.

4.4 WIRING DIAGRAMS

Several schematics and wiring comments as in the diagram aside are proposed in Annex I of this manual.

The diagram aside gives an example of hybrid system for remote site with some renewable energy sources and single phase generator.

These diagrams are indicative, and in any case the wiring is subsidiary to compliance with local standards and practices, under the responsibility of the installer.

Comments regarding the letters / and / or numbers cited in the diagram aside and of those in the appendix are given in sect. 16 to 19.

The elements of these diagrams are referenced by a capital letter when relates to the alternating current (AC) elements.

The elements referenced by a lowercase letter relates to the direct current elements (DC part of the diagram.)

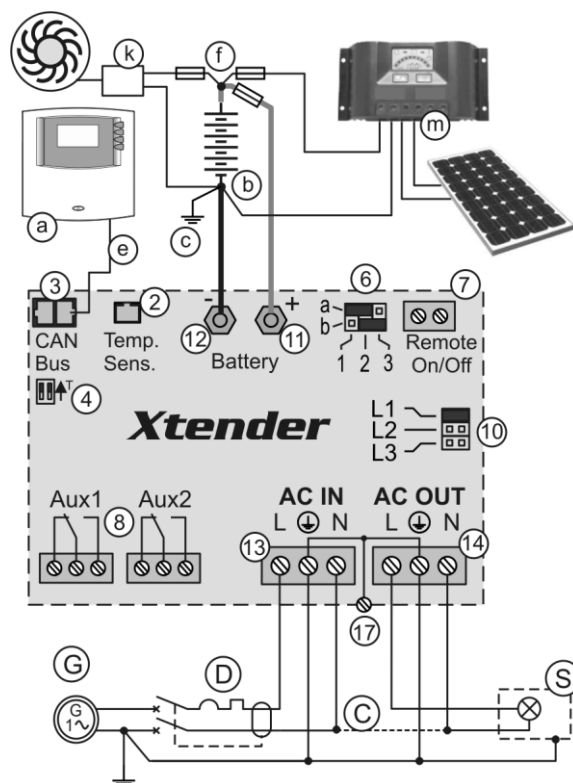

4.5 CONNECTING THE BATTERY

The terminals of dc input / output of the apparatus (11) - (12) P. 9 are intended to be exclusively connected to a battery, usually of lead acid batteries with gelled or liquid electrolyte

 The use of the Xtender connected to any other type of DC source without battery (buffer) is strictly prohibited and not cause significant damage to the device and / or at source

The use of other battery type like Ni-Cd, Li-Ion or other is possible subject to a proper setting of load profile in accordance with the specifications of the manufacturer of the battery and under the responsibility of the installer

 Each Xtender is connected directly to the battery through its own protective device (fuse or circuit breaker. It should never be connected to the output of a DC voltage regulator like solar regulator, without having the battery as buffer.
All other consumers or sources are connected directly to the battery by their own protective devices. (See details (f) on Fig. 11-18)

Lead batteries are usually available in 2 V, 6 V or 12 V block types. In the majority of cases, in order to obtain an operating voltage that is correct for Xtender usage, several batteries must be connected in series or in parallel depending on the circumstances.

 In multi-unit systems, all Xtenders from the same system must be connected according to the same battery bank.

The various cabling options are presented in figures 5a-5b (12 V), 5c-5e (24 V) and 6a to 6d (48 V) in appendix I of this manual.

4.5.1 Battery cable cross-section and DC protective devices

 The battery cables must be protected by one of the following measures in all cases:
- protection device (fuse) at each pole
- protection device (fuse) on the pole not connected to the earth

Range	Battery fuse	Cable cross-section (<3m)
XTS-900-12	100A	25mm ²
XTS 1200-24	80A	25mm ²
XTS-1400-48	50A	16mm ²
XTM-4000-48	200A	50mm ²
XTM-2600-48	100A	25mm ²
XTM-3500-24	300A	70mm ²
XTM-2400-24	200A	50mm ²
XTM-2000-12	300A	70mm ²
XTM-1500-12	250A	70mm ²
XTH-8000-48	300A	95mm ²
XTH-6000-48	300A	70mm ²
XTH-5000-24	300A	95mm ²
XTH-3000-12	350A	95mm ²

The battery cables must also be as short as possible. It is always preferable to keep the cable at the negative pole of the battery as short as possible. In order to avoid any further loss and protection redundancy, the XTH does not have an internal fuse. A protective device (f) must be installed as close as possible to the battery and sized according to the table on side.
The recommended cable cross-sections are valid for lengths less than 3 m. beyond this length it is strongly recommended oversize the battery cables.

For safety reasons, we recommend an annual check on the tightness of all connections. For mobile installation the connections should be checked more frequently for tightness.

 The cable lugs must be carefully fixed and tightened sufficiently to guarantee minimum loss. Insufficient tightening may cause dangerous heating at the connection point.

4.5.2 Connecting the battery (Xtender side)

Insert the cable glands supplied on the battery cable before tightening the cable lugs. Crimp the cable lugs and fasten the cable gland on the device. Repeat this for the second battery cable. Fix the battery cables to the appropriate connections „+ Battery “and „- Battery “. The M8 screws must

be very well tightened.

On XTM range, you can insert, if required, a fuse directly on the positive connection to the battery following the below procedure.

4.5.3 Fuse mounting on battery positive pole (XTM only)

A fuse delivered with the unit (XTM) can be mounted directly on the positive connecting pole to the battery respecting the below stacking order.

	The XTS is equipped with an electronic protection device protecting it from accidental reversal of polarity of the battery. This does not exempt of installing a protective device close to the battery
---	---

The presence of this fuse does not exempt an installation of a protective device (fuse or circuit breaker) as close as possible of the battery.

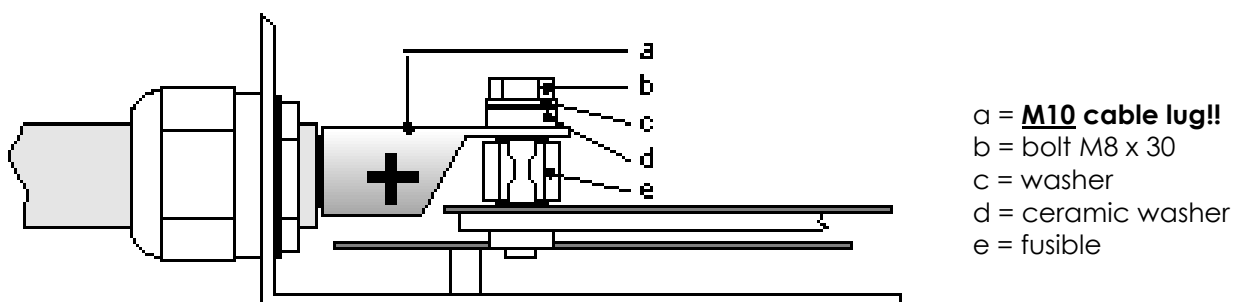

	Be careful with the orientation of the ceramic washer. There is a small lip on one side which must fit into the M10 cable lug's hole.
---	---

4.5.4 Battery-side connection

	Before connecting the battery, carefully check the voltage and polarity of the battery using a voltmeter. Incorrect polarity or over-voltage may seriously damage the device.
---	--

Prepare the batteries for connection: appropriate battery clamps, protection device (f), cable in good conditions with correctly fitted clamps.

Fasten the negative cable on to the negative pole (-) of the battery and the positive cable on the open protection device (f).

	When connecting the battery, a spark may occur when connecting the second pole. This spark is normal and due to the load of the internal filtering capacity of the Xtender even if the unit is halted by the main on off command (1).
---	---

	As of the connection of the battery, it is necessary to check that the parameter values of the Xtender are consistent with the recommendations of the battery manufacturer. Non-conforming values may be dangerous and/or seriously damage the batteries.
---	---

The default values of the battery's charge threshold level are shown in fig. 3a and specified in the parameter table p.43. If they are not acceptable when compared to the battery's manufacturer's specification, it is necessary to modify them via the RCC 02/03 remote control before connecting the voltage sources on the AC input (charger). Samlex Europe is not responsible for default values not corresponding with the recommendations of the manufacturer.

If the factory settings are modified, the new values must be entered on the parameter table on p. 43 of this manual. The default values proposed by Samlex Europe are the usual values for lead acid

battery or gel batteries (VRLA or AGM).

The cabling and connection of the installation should only be carried out by an appropriately qualified professional. The installation material such as cables, connectors, distribution boxes, fuses, etc. must be adapted and must conform to the applicable laws and regulations the application under consideration.

4.5.5 Earthing the battery

One of the two battery conductors can be earthed. This may be either the positive or negative pole. In all cases the installation must conform to the local regulations and usage or specific standards associated with the application.

In case of earthing, the earthing conductor cross-section must at least be equivalent to the cross-section of the battery conductor. The earthing of the equipment must also adhere to these regulations. In this case the use of the additional earthing screw is recommended ((17) P.11/12, which is located at the front of the device between the two lower fastening screws.

4.5.6 Connecting the consumers at the AC output



High voltages may be present on the connection terminals (13) and (14). Make sure that the inverter is deactivated and that there is no AC or DC voltage present on the AC IN terminals and battery terminals, before proceeding with the connection.

The 230 V consumers must be connected on the "AC OUT" (14) connection terminals with the wire cross-section conforming to the standards with regard to the rated current at the Xtender output (see fig. 1a). Distribution must conform to the local standards and regulations, and generally, be realised via a distribution table.

The Xtender terminals are marked in the following way:

N = neutral, L = live

= protective earth (connected to the enclosure of the device).

4.5.6.1 Sizing of AC output protective devices:

If protective devices are installed at the output, we recommend B curve devices. They will be sized at maximum to the highest the value listed on the unit's nameplate at point (37) (Fig. 1a of the Appendix) or by the addition of the first value plus the value of the input protective device. (i.e. inverter current + input current).

Cross-sections of downstream wiring must be sized accordingly

On the model XTS remove the cover plate by unscrewing the three screws (A figure below) to access the input/output AC terminals (13-14) and protective earth (15).

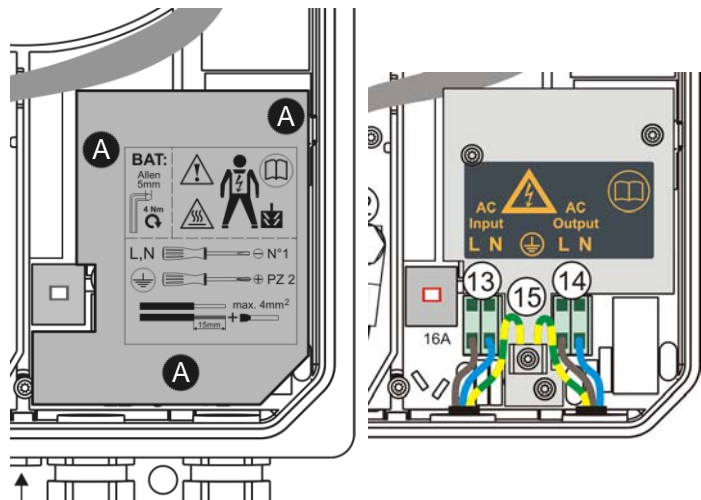

No downstream protective device is formally required if cross-sections of cable used for distribution satisfy regulatory requirements for the largest rated output current listed on the nameplate at the point (37) of Appendix 1a.

If the source assistance function (Smart Boost)(see sect.7.2.2– p.25 is not used, the size of the protection device for the output (F) will be established at a maximum value equal to the rated current of the inverter, or at the maximum value of the protection device at the input (H) if that one exceeds the rated current of the inverter.

If the AC input (13) is not used the protective device will be sized equal or smaller than the smaller value indicated on the nameplate on tag (37)

	<p>Due to the source assistance function (Smart Boost) the current at the output of the device may be higher than the rated current of the inverter. It is the sum of the current supplied by the additional source and the current supplied by the inverter. In this case, the dimensioning of the output cables will be carried out by adding the current indicated on the protection device (H) located on the upstream of the unit, to the nominal current of the inverter. (See fig. 1a and chap. 7.2.2.4 – p. 26)</p>
---	---

4.5.7 Connecting the AC supply sources

The Xtender is intended to be supplied by alternative voltage sources such as the public grid or a generator. Check that the rated voltage of the source corresponds to the rated voltage (34) of the Xtender specified on the nameplate (fig. 1b)tag(34).

The source must be connected to the input terminals marked "AC INPUT" (13) with sufficient wire cross-section, depending on the power output of the source, and protected by a protection device of the appropriate calibre. This will be at the **maximum 50A for XTH and XTM range and 16A for XTS appliances.**

The terminals are marked in the following way:

N = neutral, L = live

 = protective earth (connected to the enclosure of the device).

	<p>An additional earthing terminal (17) is present between the two fastening screws at the bottom of the unit. It can be used instead of a connection on the input terminals of the device, particularly when cable cross-sections used at the output do not allow the use of a three-wire cable (live, earth and neutral) through the conduit glands of the connection cables of the input and output (AC IN and AC OUT), or when the earthing of one of the poles of the battery. PE required using same or greater cross-sections than the battery cable.</p>
---	--

4.5.8 Wiring auxiliary contacts

These contacts are reversing contacts that are potential-free available in XTH and XTM units. On XTS models, these auxiliary contacts are available on the external auxiliary relay module (accessory) ARM-02 (see sect. 9.5 – p. 34). The admissible currents and voltages for these contacts are 16 A: 250 VAC/24VDC or 3 A: 50 VDC max. The Contact is shown as activated when the corresponding LED is lit. The representation of the contact near the terminals corresponds to the status of the contact when not activated.

The cabling of these auxiliary contracts depends solely on the chosen application and on the specific programming applied and cannot be described in this manual.

To dedicate/program particular functions to these contact, please refer to user manual of the remote control unit RCC-02/03

The factory-set functions for these 2 auxiliary contacts are covered in the sect. 7.5– p.29.

	<p>Any unused cable gland on the unit must be properly closed. If not, there is a high risk of intrusion of small animals inside the unit and a risk of damage not covered by warranty</p>
---	---

4.5.9 Connecting the communications cables

The XTH, XTM, and XTS with built-in TCM-01 accessory, is equipped with a pair of RJ45/8 connectors that allow information transfer via a communication bus for different consumer types which have the proprietary protocol of Samlex Europe. In this network all parties in the network are connected in series (chain).

The length of the communication bus cable must not exceed 300 m.

In a system comprising a single Xtender, the connection of the RCC-02 or RCC-03 may be conducted without stopping the Xtender (hot plug).

The communication bus will be used to interconnect other Xtender inverters in the case of a multi-unit application or to connect other types of users who have the proprietary protocol of Samlex Europe. In these cases, the plug-in of interconnected units is done only after the switch-off of the installation, by disconnecting the battery or by using the main "ON/OFF" button (1) if present.

	<p>The 2 switches for the communication bus termination, "Com. Bus" (4) <u>both</u> remain in position T (terminated) except when <u>both</u> connectors are in use. In this case, and only in this case, both must be placed in the O open position. If one of the two connectors is not in use, the two termination switches (14) will be in position T.</p>
---	--

5 XTENDER PARAMETER SETTING

All inverters of the Xtender family have many factory settings and some of them can be modified by the user or installer. Some basic parameters mentioned in Chapter 7 must be set at the commissioning. For models XTM and XTH, this setting must be done by connecting the remote control described in RCC-02/03 chap.7.3.1 - p.36. For the model XTS 4 of them can be done directly into the unit before powering up.

Many features and associated parameters not described in this manual are described further in the manual accompanying remote control RCC-02/03 or downloaded from the website www.samlex.com

5.1 BASIC PARAMETER SETTING IN THE XTS

For XTS models, the 4 parameters / basic functions below can be modified directly in the compartment inside the door. All other parameters can be adjusted, if necessary, via the remote RCC-02/03 and communication module TCM-01.

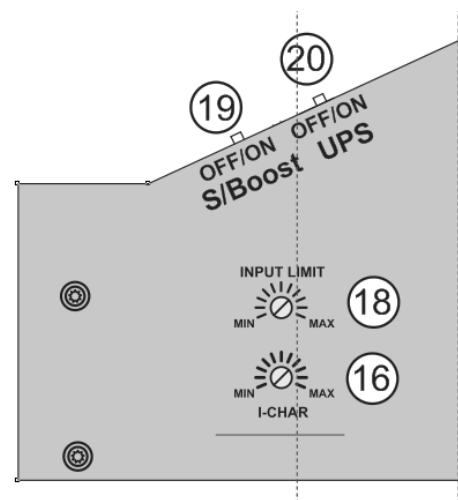

	<p>Before opening the enclosure, it is mandatory to disconnect all AC and DC sources (battery) of the product to avoid any risk of electrical shock.</p>
--	--

These 4 parameters can be set as below:

- The battery current charge {1138} as described chap. 7.3.2 - p.28 by the potentiometer (16)
- The max. AC source (input limit) {1107} as described chap. 7.2.2 - p. 25 by the potentiometer (18)
- The source current assistance (Smart boost) function {1126} as described chap.7.2.2.1 - p. 25 by the slide button (19)
- The type of detection of AC-input loss (UPS) Fast/Tolerant/slow {1552} as described chap. 7.2.1- p. 24 by the slide button (20)

6 POWERING UP THE INSTALLATION

	<p>It is imperative that the closing cap for the connection compartment be installed and screwed tight before the installation is energised. There are dangerous voltages within the interior of the connection compartment.</p>
---	--

The Power up of the Xtender must be carried out in the order given below. Any Power off must be carried out in the reverse order.

6.1.1.1 Connecting the battery

	<p>A too high or inappropriate battery voltage may seriously damage the Xtender. For example, installing a 24 V battery in the Xtender 3000-12.</p> <p>If the Xtender XTH or XTM) has been connected the wrong way around by accident (incorrect polarity of the battery) it is highly likely that the protection fuse on the battery cable may melt and will have to be replaced. If such is the case, it will be necessary to disconnect all the connections to the Xtender including the battery. If, after replacing the fuse, the Xtender proves not to work correctly after reconnecting the battery with the correct polarity, it will have to be returned to your distributor for repair.</p> <p>The XTS is electronically protected against reverse polarity. In case of reverse polarity connection, the unit will remain off. No alarm will signal the fault. It will operate normally after recovery of the correct polarity.</p>
---	---

6.1.1.2 Putting the Xtender(s) in operation using the main ON/OFF switch (1) if present

The Xtender is supplied and is ready for operation. If you require immediate start-up of the inverter when the battery is powered up, the main switch (1) must be in the "ON" position and the parameter {1111} activated. If special configurations or settings are required by the system, it is recommended to do so immediately according to sect. 5 - p. 22

6.1.1.3 Connecting the consumers at the output

Activate the output protection device (F) if existing, and/or press the ON/OFF button (41). The light indicator "AC out" (46) lights up or flashes (in the event of an absence of consumers).

6.1.1.4 Activating the input circuit breaker(s) (H)

If an AC source (generator or electrical grid) valid in frequency and voltage is present at the AC input, the device automatically goes into transfer and will start to charge the batteries. The consumers at the output are therefore supplied directly by the power source present at the input.

Your installation is now in operation

7 DESCRIPTION OF THE MAIN FUNCTIONS

7.1 INVERTER

The Xtender is equipped with a high-performance inverter which supplies a perfect and very precise sine wave. Any unit designed for the 230 V/50 Hz electrical grid (or 120V/60Hz for model XTxxx-01) may connect to it without any problem, up to the rated power out of your Xtender. The inverter is protected against overloads and short-circuits.

Thanks to the largely over-dimensioned performance level, loads of up to three times greater than the Xtender's rated output can be faultlessly supplied for short (3 sec) periods of use, thus allowing motors to be started up without any problem.

When the Xtender is operating the LED "ON" (43) is glowing.

When the Xtender is in inverter mode, the LED "AC out" (46) is glowing. If it flashes, the inverter is in "load search" mode (see following sect. "Automatic load detection").

7.1.1 Automatic load detection (load search)

In order to save battery energy, the Xtender inverter stops and automatically goes into load search mode when the detected load is lower than the sensitivity set by the parameter {1187}. It automatically goes back into operation when a power consumer greater than this value demands it. The indicator (46) flashes if the inverter is in "load search" mode, which also indicates that the AC voltage is present at the output in an intermittent form.

The detection threshold for the absence of loads can be adjusted according to the parameter range {1187} by means of the RCC-02/-03 remote control. When the parameter is set to 0 the inverter will still operate even in the absence of any consumer.

In load search mode (standby) the system will thus consume minimal power from the battery (see table of technical data p. 44).

7.2 TRANSFER RELAY

The Xtender can be connected to an alternative power source such as a generator or public network. When the voltage at the entry satisfies the voltage {1199 + 1470} and frequency {1505 - 1506} parameters, the transfer relay will be activated after a delay {1528}. This delay may be adjusted (extended) to allow a fully stable status of the generator before transfer.

When the transfer relay is activated, the voltage present at the input of the Xtender is available at the output for the consumers connected. At the same time the battery charger goes into operation.



When the transfer relay of the Xtender is active, the voltage at the output of the Xtender is equivalent to that which is present at the input and cannot be influenced or improved by the Xtender. The consumers are supplied by the source present at the "AC IN" input via the transfer relay.

The maximum current of the transfer relay is 50 A for XTH and XTM model. It is of 16A in XTS model. The sharing of energy between consumers and the battery charger is adjusted automatically (see sect. 7.2.2 – p. 26). The transfer relay will be deactivated when the input voltage no longer satisfies the parameter {1199} or {1432} min. and max. voltage and frequency at the input or when the current limit {1107} is exceeded, if the exceeding of this limit is prohibited {1436}. It then passes immediately into inverter mode. In this case the loads are supplied exclusively by the battery via the inverter (see sect. 0 – p. 26). This switching always takes place automatically.

The presence of increased dynamic loads (such as pneumatic angle grinders, etc.) may lead to an undesirable opening of the transfer relay due to the weakness of the source. To this case, a delay in the opening of the transfer relay can be adjusted with the parameter {1198}.

When the generator stops, the change from transfer mode to inverter mode normally takes place without any interruption of the output voltage. The interruption will be 20 ms in case of input voltage sudden disappearing when the type of detection of input loss (UPS) {1552} is selected to "tolerant".

7.2.1 Type of detection of AC input loss (UPS)

When the Xtender is connected to the public grid or to a generator supplying stable and clean AC voltage, the type of detection of input loss {1552} can be selected to "fast". In this mode, perturbation or lack of voltage of less than 1 millisecond can be detected, switching the unit in

inverter mode immediately.. This mode guarantees a zero or maximum of 15 ms transfer time
 This mode should not be used in presence of highly disturbed utility grid or with a low power generator or a generator supplying a poor quality voltage. In that case the parameter {1552} will be set on "tolerant". In the XTS model, this can be selected by positioning the UPS slide switch (20) in "off" position. The tolerance of this mode is adjustable with the parameter {1510} if required.
 The "tolerant" UPS mode insure a interruption time of max. 20 milliseconds.
 In rare cases, due to the low quality of the source, and if the transfer relay switches too frequently, it is possible to further reduce the sensitivity of detection AC input loss of by changing the parameter {1552 }to "slow" via remote control RCC-02/03. In this case, the interruption of power will be 40 ms max



If the Xtender is connected to a generator, this must have a power at least equal to half of the power of the Xtender(s) to which it is connected.

7.2.2 Limiting the AC input current "Input limit"

7.2.2.1 Principle

In order to best use the resources available at the input (depending on the generator size or the grid output) and to protect the source from overload, it's possible to adjust the limit of the input current with the parameter {1107}.

The Xtender will automatically distribute the available power to the charger and the user and supply the balance of power if the load demand exceeds the fixed limit thanks to the current assistance function so called "smart boost".



Due to the current assistance feature, the battery can be fully discharged despite the presence of the grid or the generator! The average power consumed by the user must not exceed the power of the source, at the risk of discharging the battery.

This system proves to be a decisive advantage particularly in all mobile systems (boats, leisure vehicles and service vehicles) that are frequently connected to sources with a limited value such as a portable or camping power supply. Despite a limited source, all the greater power applications downstream of the Xtender remain functional.

Despite a limited source, all loads connected downstream the Xtender remain functional!

The system will reduce automatically the charging current– from its target value {1138} to 0 – according to the current used at the output and the the maximum current available at the input set by the parameter {1107}. The greater the current at the output, the more the part of the current at the input assigned to charging the battery is reduced. If the current exceeds the limit {1107}, the Xtender will supply the balance current from the battery.

The wiring of the system (cable gauge) must take into account this particular function which allow to have the sum of the current supplied by the inverter plus the current supplied by the source, i.e. If the system have a 5kW source (22A) and a 5 kW Xtender, the available power at the output is 10kW! In this example, the wire gauge must be chosen for 45A.

7.2.2.2 Exceeding input limit current:

If, despite the decrease in current from the charger and using the source current assistance the limit is exceeded, the transfer relay will remain activated and the source may then be overloaded, causing the opening of the protective device upstream (H).

Exceeding the limit may be prohibited by the parameter {1436}. In this case, if the current exceeds the limit {1107}, the transfer relay will open and the user then powered exclusively by the inverter, as long as the output current exceeds the current limit input. If the input current limit is exceeded due to a short circuit downstream, the transfer relay will remain activated and the protective device upstream of the Xtender (H) will trip.

7.2.2.3 Second value of input current limit:

A second value of the input limit, to be activated by the command entry (see sect. 7.7 p.29, is programmable by the parameters {1566} (Use a different value for the maximum current of the AC source) and {1567} (Second maximum current of the AC source).



In the case of mobile applications the installation of an RCC-02/-03 remote control is recommended, in order to be able to adapt the value of the input current limit if necessary, for each connection to a limited grid.

7.2.2.4 . Deactivation of the source assistance function (Smart Boost):

This feature the source current assistance (smart boost" can be disabled by setting {1126}.

The remote RCC-02/03 is necessary to disable the function on the model XTH and XTM. On the XTS model it is possible to disable it by selecting the slide button (19) in OFF position

7.2.2.5 Automatic reduction of the current limit input

When the device is connected to a low power generator, most often, the voltage of the generator falls down before its rated power. To compensate partially this side effect, the Xtender has a system of automatic reduction of the input current limit, if the voltage drops beyond a threshold set by the parameter {1309}+ {1433 }, to fall to zero when it reaches the value set by parameter {1309}. This avoids overloading the generator and too frequent transition of the transfer relay.

This feature is also used when a variable power sources is connected to the input of the Xtender. This is particularly the case of 230Vac alternators type "Dynawatt" coupled to drive motors whose speed varies. These devices have their source voltage decrease depending on the available power. A correct setting of thresholds {1309} and {1433} ensures continuous power output with the "Smart Boost"

This feature can be disabled by setting the {1527} especially when the Xtender is connected to a public network.

7.2.2.6 Setting the current "Input limit"

The maximum input current can be adjusted by the knob (18) on the XTS or via remote control RCC-02/03 on other models or on the XTS with the module TCM-01. The parameter {1107} is part of the basic parameters of the device and must be adjusted at commissioning (see sect. 5 p. 22) depending on the capacity of the source as follows:

- If the device is connected to a network: the value is sized according to the upstream protective device (fuse or circuit breaker) or a lower value if desired.
- If the device connected to a generator, the following empirical formula can be used:

Generator power below 1 kW: $0.7 \times P_{nom} / U_{ac}$

Generator power below 3 kW: $0.8 \times P_{nom} / U_{ac}$

Generator power above 3 kW: $0.9 \times P_{nom} / U_{ac}$

Given the wide divergence of performance and quality of available generators on the market, these formulas are approximate and are not a guarantee of proper adjustment of the installation.

7.3 BATTERY CHARGER

7.3.1 Working principle:

The battery charger for the Xtender is completely automatic and is designed in such a way as to guarantee an optimum charge for the majority of the lead-acid or gel batteries. Once the transfer relay is activated, the battery charger goes into operation and the charge indicator (44) lights up.

The charging process is at 3 levels (I/U/Uo) as described in figure below.

this process guarantees optimum charging of the batteries. The charging current is given by the parameter {1138} and can be adjusted continuously from 0 to the nominal value with the help of the RCC-02/-03 or with the rotating knob (16) inside the model XTS (see sect. 5.1 – p. 22). All times and threshold can be adjusted with the remote control unit RCC-02/03.



If the battery voltage is lower than the critical disconnection threshold {1488} operation of the charger will be automatically prevented. Only the transfer relay is authorised to operate in this case. The battery must then be recharged by an external source up to a voltage higher than the critical disconnection threshold in order to allow the Xtender charger to operate.

The charge cycle, programmed by default, as shown in the example described in the figure opposite, runs automatically.

The line (28) indicates the development of the battery voltage.

The lower line (29) indicates the battery current (input and output).

The cycle starts with a continuous current charge (**a**) adjusted by default according to the parameter {1138}. If the ambient temperature is increased or the ventilation blocked, the current may be reduced and become lower than the selected current.

Once the absorption voltage {1156} is reached, the cycle passes to voltage adjustment mode (**d**), known as the absorption phase, the duration of which is set by the parameter {1157}. The minimum interval between two absorption cycles is limited by the parameter {1161}.

At the expiry of the absorption time, or if the absorption current is lower than the parameter {1159}, the voltage is set to a lower value {1140}. This phase (**e**) is known as the maintenance or "floating" phase. Due to the limiting function for the input current (see the above p.25), it is perfectly normal for the charge current to be lower than the selected current if the limit of the AC input current {1107} is reached (b). In this event the AC IN indicator (45) flashes. The charge current will be limited too if the battery voltage ripple is higher than 0,5V/cell.

If the "Smart Boost" function is activated {1126} and the power required by the consumer exceeds the power of the source, the battery will be discharged (c) despite the presence of the grid or the generator. In this case the LED "charge" (4) goes out. The consumers must ensure that they have average consumption that is less than the power of the source (generator or public grid) in order to avoid a complete discharge of the battery. These situations are set out in the figure below.

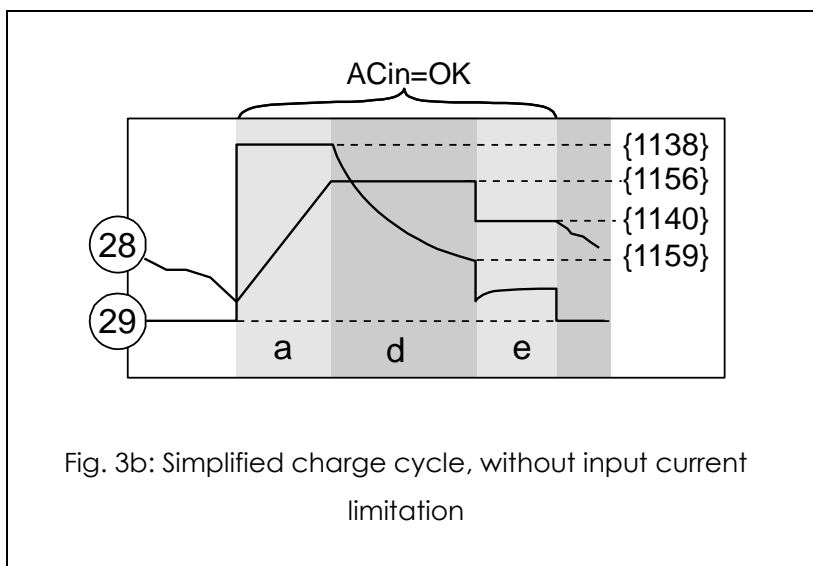
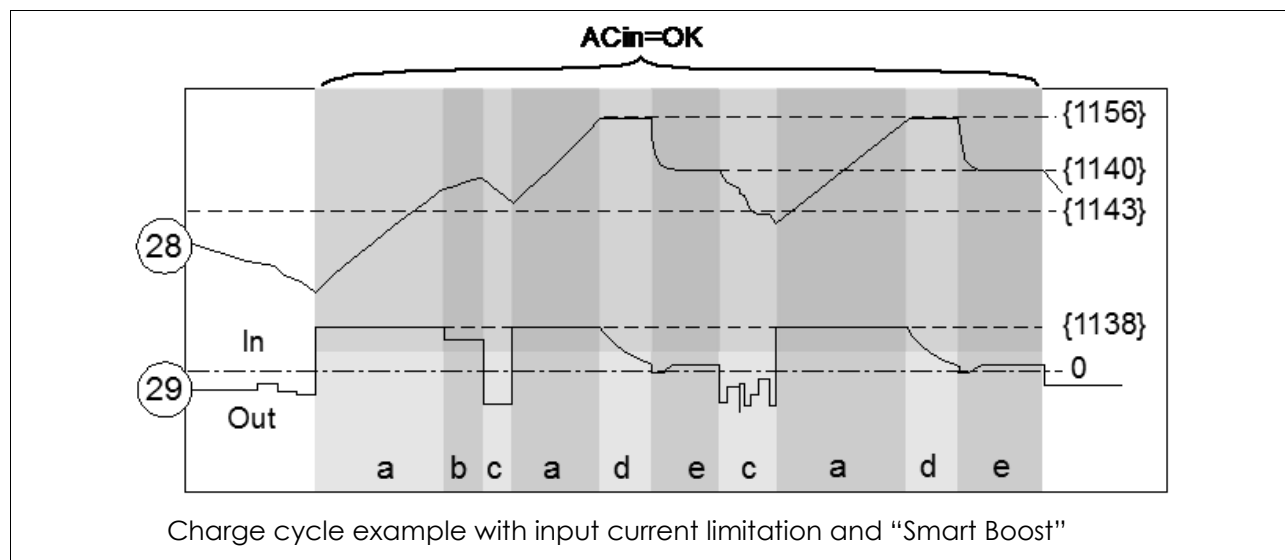

Fig. 3b: Simplified charge cycle, without input current limitation



Charge cycle example with input current limitation and "Smart Boost"

If the BTS-01 temperature sensor is used, the voltage adjustment thresholds for the battery are corrected in real time by means of the battery temperature. The value of this correction is set by the parameter {1139} in the parameter table p.43.

i

Much more complex charge profiles or exclusion of the charger can be configured using the RCC-03/03 remote control.

	<p>Parameters of the battery charger is under the responsibility of the operator. Incorrect parameter that does not correspond to the charging methods of the battery recommended by the manufacturer may be dangerous and/or considerably diminish the battery service life. If the factory settings are modified, it is imperative that the new values be entered in the parameter table p. 43</p>
---	--

7.3.2 Battery charger current setting:

The maximum charging current can be adjusted by the knob (16) on the XTS or via remote control RCC-02/03 on the other models or on the XTS with the module TCM-01. The parameter {1138} is part of the basic parameters of the device and must be adjusted at commissioning (see chap. 5 - p. 22) depending on battery capacity. It will be chosen in principle a value between 0.1 and 0.2 x the nominal battery capacity C10. (i.e. 10A for a battery of 100 Ah/C10)

7.3.3 Battery protection

The battery is protected against deep discharge by stopping the inverter if the low voltage disconnection level {1108} is reached. The indicator (52) flashes once when the battery has reached the disconnection threshold and the inverter will stop some time after {1190}. This threshold can be dynamically corrected {1191} with an advanced algorithm that computes automatically the battery voltage compensation in function of the instantaneous power. This correction may also be manually fixed {1532} by setting the low voltage disconnection at full load {1109}. These dynamic corrections can be deactivated by setting the parameter {1191}. The inverter will stop immediately if a critically voltage of 1.5V/cell is reached. The inverter will restart automatically when the battery voltage has reached the restarting threshold {1110}.

This restarting threshold {1110} can be automatically readjusted if the parameter {1194} is activated, in order to better protect the battery against repeated cycling in an "almost empty " state of charge. The restarting threshold is then incremented {1298} up to a maximum value {1195}, whenever the LVD (low voltage disconnection) is reached. The restarting threshold will be reset to its initial value when the value of parameter {1307} is reached.

If the inverter is repeatedly {1304} encountering a low voltage disconnection in a short period {1404}, it will stop permanently and will only start again via an operator's manual restart.

7.4 XTENDER PROTECTION

The Xtender is protected electronically against overloads, short-circuit, overheating and reverse current (cabling of a voltage source on AC out).

7.4.1.1 Protection in case of overload:

In the event of overload or short-circuit at the output, the inverter stops for some seconds {1533} {1400}, and restarts. If the inverter is repeatedly encountering this situation {1300} in a short period, it will stop permanently and will only start again via an operator's manual control.

7.4.1.2 Protection against overvoltage:

If the battery voltage exceeds the value set by the parameter {1121} the inverter stops and starts up again when the voltage is less than {1110}. If the Xtender is repeatedly encountering this situation 3 times during one minute, it will stop permanently and will only start up again via an operator's manual control.

	<p>A battery voltage greater than 1.66 x the nominal voltage may lead to significant damage or destroy the device.</p>
---	--

7.4.1.3 Protection against overheating

, Insufficient ventilation, increased ambient temperature or obstructed ventilation may lead to overheating of certain internal components of the unit. In this case, the device will automatically limit its power output as long as this abnormal situation persists.

7.4.1.4 Protection against battery reverse polarity

The Xtender is protected from reverse polarity by means of an external fuse installed on the battery.



The XTS is equipped with a full electronic protection device protecting it from accidental reversal of polarity of the battery. This does not exempt by installing a fuse close to the battery. In case of reverse polarity, the fuse will not be destroyed and the unit will operate normally after restoring the correct battery polarity

7.5 AUXILIARY CONTACTS

The XTH, XTM and XTS, with TCM-01 and ARM-02 module, have two dry reversing contacts that are potential-free. The status of the contacts in deactivated mode is indicated by the annotations, N.C. = normally closed and N.O. = normally open. When the contact is activated

Maximum contact loads: 230 Vac / 24 Vdc: 16 A or: max. 50Vdc/ 3A

These dry contacts are programmed by default for the following functions:

Contact no. 1 (AUX 1): The contact has a function of automatic start of generator (two wires). The contact will be activated when the battery voltage is below a value, during a given time fixed by parameters {1247/48}/{1250/51}/{1253/54} The contact will be deactivated or when the charge cycle has reached floating {1516}, or when the "Aux. 1 deactivation voltage" {1255} is reached during a predetermined time {1256}



The voltage of the battery is automatically compensated according to the instantaneous battery current the same way as it is done for compensation of LVD (see sect. 7.3 – p.26) if parameter {1191} is activated.

Contact no. 2 (AUX2) : alarm contact by default. It is deactivated when the inverter is out of service or is working at reduced performance, either because of manual control or if there is an operational fault such as overload, under-voltage of the battery, over-temperature, etc.

If the operator or installer requires different behaviour for the auxiliary contacts, they are both freely and individually programmable depending on the battery voltage, the output power, the inverter status, the internal clock and the Battery state of charge (if BSP module is present) . These setting can be done with the the RCC-02/-03 (remote control unit)

The intelligent programming of the auxiliary contacts allows many applications to be considered such as:

- Automatic startup of the generator (two or three wires)
- Automatic load shedding of lower priority loads of the inverter (2 sequences)
- Global or individual alarm
- Automatic disconnection (load shedding) of the source



For more information on the auxiliary contacts nr 1 and 2 programming, do refer to our application notes available on Samlex web site www.samlex.com. Like:
AN003: Anti-blackout system for grid connected application (Solsafe)
AN005: Automatic management of 2 different energy sources
AN007 Automatic start of a generator

7.6 THE REAL TIME CLOCK

The XTH, XTM and the XTS with optional TCM-01 module (see sect. 9.4 – p. 34) has a real time clock that allows notably to program the functioning of the auxiliary contacts according to time schedule. This clock must be adjusted via the use of the RCC-02/-03 remote control.

7.7 ENTRY COMMAND (REMOTE CONTROL ON/OFF)

This function and associated terminal block (7) is available as a standard on XTH series. It is available on the series XTM and XTS with optional TCM-01 module (see sect. 9.4– p. 34) using the external module RCM-10 in option. See sect. 9.3 p.33.

This entry can be used to drive one or more function that you can choose thru programming with the RCC-02/-03.

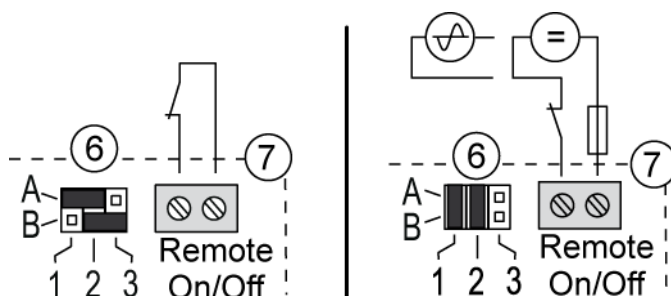

There is no dedicated function from factory. In multi-unit configuration (see below) the chosen functionality must be the same in every unit in the system. Only one unit can be wired to apply the function to every Xtender in the system. If the entry command is used as an emergency stop, (all functions halted), it has to be wired on the unit with the highest serial number (master) of phase one.

The function is activated, or by opening /closing a potential free contact, or by applying a voltage on the entry.

On XTH model, the wiring is done across the entry terminal block (7). The jumpers (6) must be correctly positioned according to the chosen variant as described in the figure opposite.

Driving by a dry contact: the jumpers are left in original factory setting A1-2 and B2-3

Driving by a voltage (Max. 60 V eff./30mA): the jumper are positioned A+-B1 and A2-B2

On XTM and XTS + TCM-01, the wiring of this entry is done on the RCM-10 plug according to the wiring example on the figure aside, or wired thru the external module RCM-10 according to sect. 9.3 – p.33

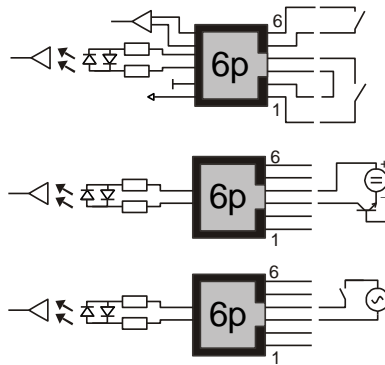

Main ON/OFF (only with dry contact)

Command entry with dry contact

Command entry with external DC source. (Max. 60V d.c / 60 mA)

Entry command by external AC source. (Max. 60 V a.c./ 60 mA)

8 MULTI-UNIT CONFIGURATION

Several Xtenders can be used in the same system, either to create a three-phase system or to increase the power output of a single or two phases. The implementation of this configuration requires particular precautions and it must be installed and commissioned by qualified personal only.



When multi-unit system is commissioned, the software's version of every unit will be automatically checked and units may refuse to start in case of incompatibility. If so, an upgrade of every units is be required with the RCC-02/03 and the last software version available by the manufacturer. (Read the RCC-02 user's manual to perform this operation).



In Multi-units system every Xtender in the system shares the same battery bank. Separate battery bank are no allowed

In these multi-unit systems, the units must be interconnected via a communication bus connected to the connectors (3) by a cable (**art. no. CAB-RJ45-8-2**) of a maximum length of 5 metres. The XTS model must be equipped with TCM-01 to be used in multi-units configuration.

Various application examples are described from fig. 12 to fig. 19 of Appendix I.



It is important to read and adhere to the descriptions associated with each of the figures mentioned above



In multi-unit system, it is recommended to use the automatic LVD dynamic compensation. See parameter {1532}

In configuration with several Xtenders, each unit is controlled independently using the ON/OFF push button (41). When the on/off control is given via the RCC-02/03 remote control, it is applied simultaneously to all units.

8.1.1 Three-phase system

Three Xtenders of the same voltage (power or type can be different) can be used and combined in order to establish a three-phase grid. An example of cabling in three-phase is given at figs. 13.-14 of the appendix.

When 3 Xtenders are wired to form a three-phase grid, the wired phases at the input determine the jumper position for selecting the phase (10). It is vital to determine and select the phase for each Xtender. If the grid is not available at the input of the master unit (phase 1), all the units of the system will switch to inverter mode. If only a single-phase source is available, it must be connected to phase 1. The other two phases will therefore be supplied by the other two working units in inverter mode.

8.1.2 Increasing the power by paralleling units

Up to three Xtenders of same type - power and voltage- can be wired in parallel in order to increase the system's rated power output. In this configuration, all the ACin inputs of the Xtender must be wired. The most recent unit (according to the serial number) in the phase will act as the master and will decide on the operation or suspension of the units in parallel according to the consumer's power demand. The yield of the installation is therefore still optimal.

It is possible to deactivate the master/slave mode with the parameter {1547}. In that case, the load search mode is disabled.

An example of parallel connection is given in fig.12 Appendix 1 and the comments on p. 37.

	<p>If the current of the source (per phase) is greater than 50A (XTH and XTM) or 16A (XTS), a protective device max. 50A, respectively 16A must be installed on each of the 2 or 3 devices connected to the same phase. If the power source is limited to 50A, respectively 16A, only one device is common enough.</p>
---	--

8.1.3 Combined system

It is possible to combine a three-phase system with one or several phases made up of 2 or 3 Xtenders in parallel. An example of cabling is given at fig. 15.

A combination of more than one inverter on only one (or two) phase is also possible. for example, it's possible to build up one powerful phase for the most single phase consumer and the 2 other phases with only one Xtender each for the 3 phase (motor) application as in the example Fig 15 Appendix 1

It is therefore possible to combine up to nine Xtenders by running three Xtenders in parallel in a three-phase grid. Examples of cabling are given in figs. 16 to 18 Appendix 1 and the comments on p. 38.

8.1.4 Enlargement of an existing installation

Only subject to compatibility, it is most of the time possible to enlarge an existing installation by adding one or several inverters in parallel or in a three phase configuration. The compatibility of the new units must be checked by giving Samlex Europe the serial numbers of the inverters in the existing installation.

	<p>The inverters belonging to the same system must be equipped with the same software version. Take care to download the latest software version from manufacturer's website and do update <u>all</u> units of the system before the commissioning.</p>
---	---

9 ACCESSORIES

9.1 CONTROL CENTRE AND DISPLAY RCC-02/-03 (REMOTE CONTROL)

An RCC-02/-03 remote display and programming unit can be optionally connected to the Xtender via one of the two RJ45-8-type "Com. Bus" (3) connectors.

These connectors may only be used for connecting a CAN-ST compatible accessory, excluding any other connection such as LAN, Ethernet, ISDN, etc.

The RCC-02/-03 control centre is vital for modifying the parameters of the system. Many parameters and features are not described in this manual. The manual for the RCC-01/03 (downloadable on www.samlex.com) describes in detail each of these parameters and the context in which they can be used.

It also allows the following functions:

- Display of function synopsis
- Display of the measured operational values (current / voltage / power output, etc.)
- Updating of software or implementation of customised software
- upload/download of inverter parameter
- Updating of inverter parameters
- Events logging of error message
- Data acquisition of Xtender and other participants connected to the communication bus like the BSP (Battery status processor) or / and compatible solar charge controller

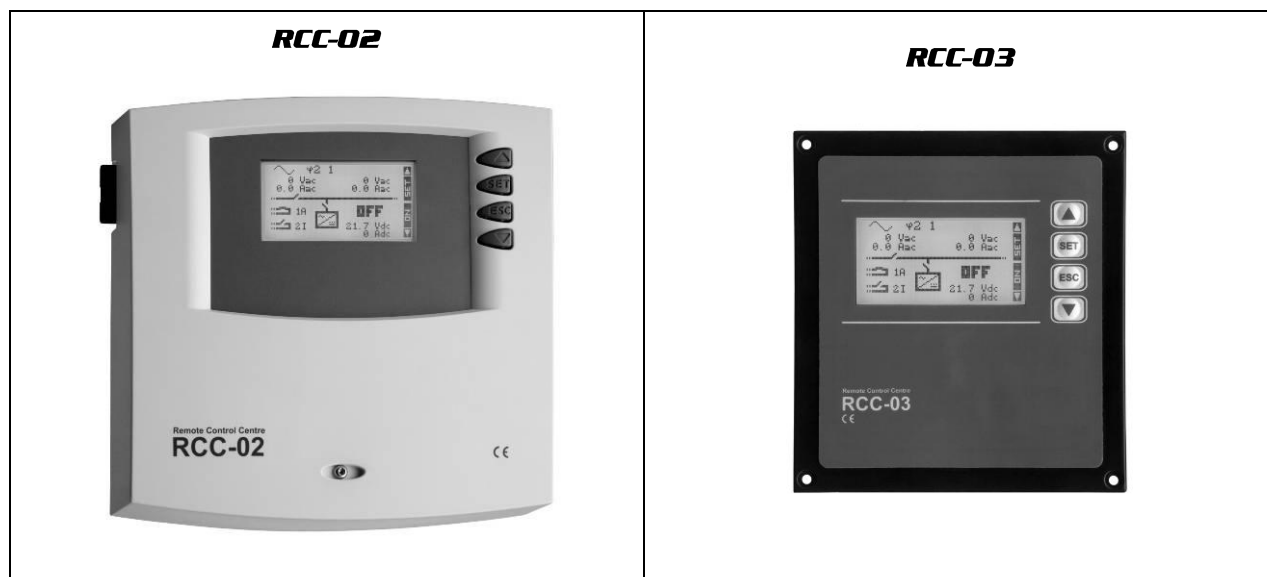

The features of the RCC-02 and the RCC-03 are the same. They only differ in their external appearance. The RCC-02 is designed for wall mounting, whereas the RCC-03 is designed as a board device.

The RCC-03 model must be taken off the table to allow access to the SD card slot (during updating, for example).

Model N°: RCC-02: Dimensions: H x W x D // 170 x 168 x 43.5mm

RCC-03: Dimensions: H x W x D // 130 x 120 x 42.2mm



The two remote control models are delivered with a 2 m cable.
Cables of specific lengths (5 m, 20 m and 50 m) can be ordered.
The article no. is as follows: CAB-RJ45-xx. The length in metres is specified as xx

Up to 3 RCC-02/-03 remote controls can be connected in series on the communication bus of one Xtender or an Xtender multi-inverter system. In a system comprising a single Xtender, the connection of the RCC-02 or RCC-03 may be done without stopping the Xtender (warm). When connecting an RCC-02/-03 remote control in a multi-unit system, it is recommended that all units in the system be stopped (disconnected from battery or by the main ON/OFF switch (1) if present) and that the communication bus on the device on which the connection is being made be

terminated.

	<p>The switch (2 for XTH) for the communication bus termination, "Com. Bus" (4) remain (both for XTH) in position T (terminated) except when <u>both</u> connectors (3) are in use. In this case, and only in this case, the switch (both for XTH) must be placed in the O open position. If one of the two connectors is not in use, the termination switches (4) (two for XTH) will be in position T.</p>
---	---

9.2 BTS-01 TEMPERATURE SENSOR

The optimal operating voltages for lead batteries vary depending on the temperature. A temperature sensor is optionally available to correct the battery voltage and guarantee an optimum charge whatever the battery temperature. The correction factor given by the correction of the sensor is set by the parameter {1139}

Article no. for the temperature sensor (including a 3 m cable): BTS-01.

Dimensions: H x W x D / / 58 x 51.5 x 22 mm.



9.2.1 Connecting the temperature sensor (BTS-01)

The temperature sensor, BTS-01 is supplied with a 3 m cable fitted with RJ11/6-type plugs. It may be connected or disconnected at any time (including when the device is in use) using the corresponding socket (2) marked "Temp. Sens." on the Xtender. Plug the connectors into the socket (2) until they click in. The temperature sensor sleeve may simply be stuck onto the battery or directly next to it. The temperature sensor will be recognised automatically and the correction made immediately.

9.3 REMOTE CONTROL MODULE RCM-10 (XTM/XTS)

The optional remote control module for XTM and XTS + TCM-01 gives the possibility to have the 2 following function:

Main ON/OFF (1) see sect.11.1 below.

This operation can only be controlled by a potential free contact.

Command entry (7) see sect. 7.7 – p.29.

This module can be mounted on DIN rail

Article n°: RCM-10

Supplied with a 5m cable (max. length 10m).

Dimensions: 45 x 78mmH

Height on rail: 40mm



9.3.1 Connection of the RCM-10 module

The control module MCM-10 can be "hot plugged" on the connector " RCM-10 "(15) without interrupting the operation of the unit.

The main ON/OFF function as described in Sect. 11.1 - p.35 may be obtained by connecting a potential free contact (1) between terminals 1 and 2. When this contact is closed, the Xtender is stopped.

Terminals 3 to 6 of RCM-10 are used as input control as described in Sect. 9.3- p.33. The function dedicated by programming can be activated or by a dry contact (7) between 5 and 6 with a connection between 3 and 4, or by an AC or DC voltage of 60 V rms max. between terminal 4 and 5.

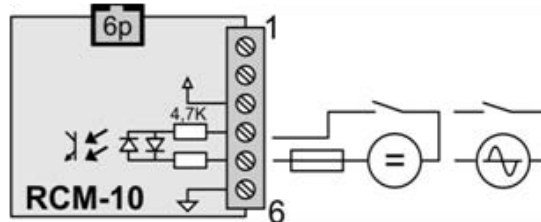
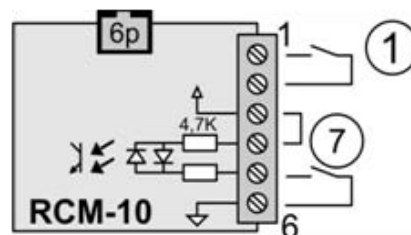

	<p>The function "main ON/OFF" can be driven only by a potential free (dry) contact..</p>
---	--

9.4 TIME AND COMMUNICATION MODULE TCM-01(XTS)

This module lets you connect the XTS to the remote control RCC-02/03, as well as to other XTS or devices available and compatible with the Xtender range.

The module also features a real time clock and connectors to connect the ARM-02, RCM-10 and BTS-01 modules.

The module is mounted inside the XTS, according to the manual delivered along with it.

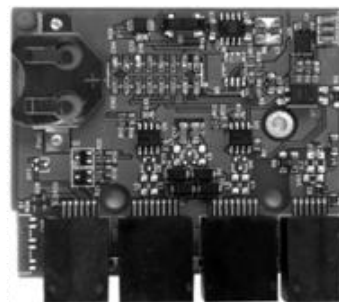

9.5 AUXILIARY RELAY MODULE ARM-02 (XTS)

This external module, connected by a 5m cable supplied with the accessory, allows XTS to have auxiliary contacts as described sect. 7.5p.29. This module can be mounted on DIN rail.

It requires the installation of the communication module TCM-01 inside the XTS



9.6 EXTERNAL COOLING FAN UNIT ECF-01 (XTS)

The External cooling fan unit ECF-01 is an optional accessory. It improves the performance of the device (see technical data p.57).

It is particularly recommended to use this accessory if the ambient temperature is high ($> 40^{\circ}C$).

This unit has a protection degree IP 54 and can be exposed to water spray without damage. It will however be not exposed to splash dirty water to prevent mud or similar particles from clogging the mechanism. The assembly instructions are supplied with the accessory

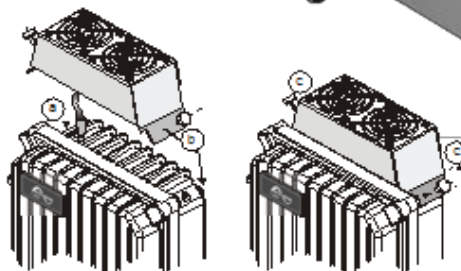

10 OTHER DEVICES COMPATIBLE XTENDER SYSTEMS

The devices listed below are compatible and can be part of a system Xtender and interconnected by the communication bus. Their complete description is available on our website www.samlex.com

10.1 BATTERY STATUS PROCESSORS BSP- 500/1200

This module is delivered with a 500 or 1200 A shunt. It allows current measurement, voltage and battery temperature. It computes the information and provides to the Xtender system all the information derived from these measures, like the state of charge, time before discharge, history of the state of charge over 5 days etc.



10.2 COMMUNICATION MODULE XCOM-232I

This RS232 module isolated allows access to most of the values and settings of devices connected to the Xtender communication bus. It also features an SD card for the acquisition of measured data, the setting of units and historic event generated by the devices.



11 CONTROL

11.1 MAIN ON/OFF CONTROL

This switch (1) interrupts the electronic supply and all the Xtender peripherals. The residual consumption on the battery is therefore less than 1 mA.

The ON/OFF switch is used only for the complete stoppage of the whole system. This switch is not available in the XTM. The function can be added with the use of the remote command module RCM-10.

11.2 DISPLAY AND CONTROL PANEL

The Xtender has a ON/OFF button and light indicators at the front of the unit, allowing clear identification of the operating mode.

(41) The ON/OFF button allows the start-up or complete stop of the system. In the systems comprising several units, each unit is started or stopped individually. For a simultaneous start-up of all the units use the dry contact control (see sect. 7.7 – p. 29) or the ON/OFF button of the RCC-02/-03 remote control.

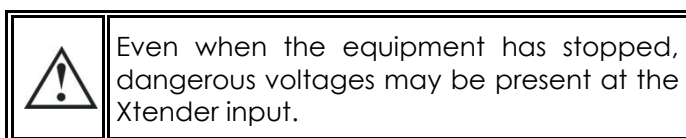

(42) This indicator lights up when the equipment has been stopped manually using the ON/OFF button (41). It also allows the cause of an unintentional stoppage of the device to be indicated via the different flashes, the imminence of a stoppage or the temporary limitation of its performance.

The table below describes the type of fault according to the number of flashes on the indicator (42)

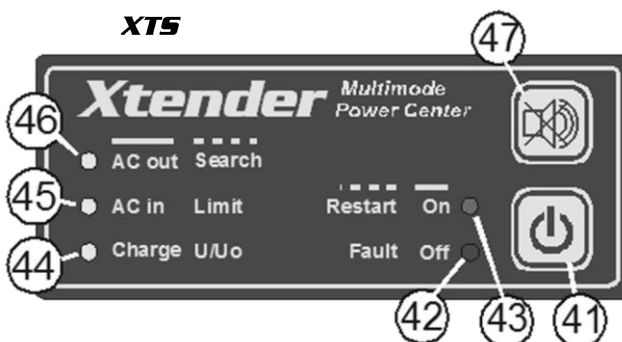

XTH et XTM

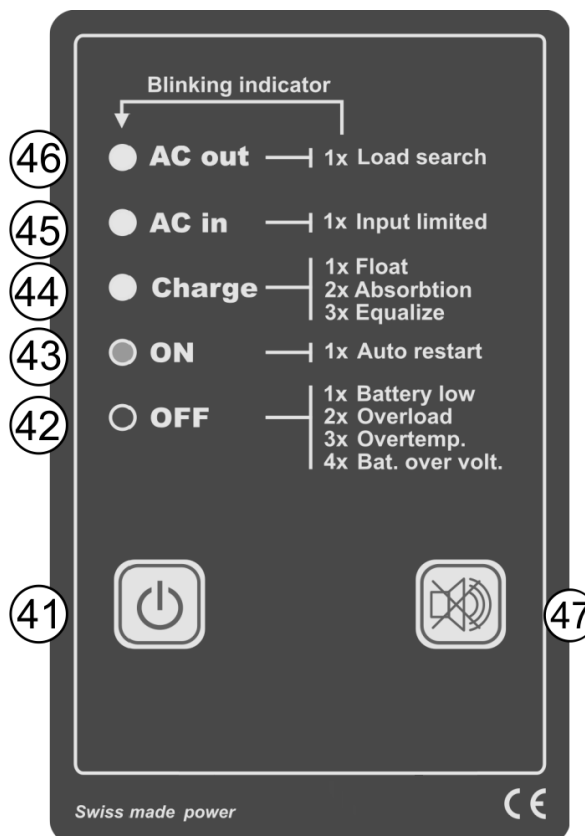

	Indicated alarm	Comment
1x	(Imminent) stoppage due to a too low battery voltage.	If the inverter has not yet stopped, it is recommended to disconnect all non-priority consumers and/or start up the generator. If the inverter has stopped it will restart automatically when the battery voltage has reached the correct value again {1110}. It can be restarted manually using the ON/OFF button (41) as long as the battery voltage is higher than 1,5V/cell. The charger remains functional as the battery voltage remain higher than 1,5V/cell. See also sect. 7.4 – p. 28.
2x	Stoppage due to overload in the equipment, due to either a short-circuit or too high load for the inverter.	In this event the equipment will make 3 restart attempts within a few seconds and will stop if the overload remains (see sect. 7.4.1.1 – p. 28). It is vital to eliminate the cause of the overload without restarting. Restarting is carried out manually by pressing the button (41).
3x	Decrease in the rated output of the device due to a too high internal temperature.	This may be due to too great a load for the device, at too high an ambient temperature or counteracted or obstructed ventilation. The power output of the device will therefore be limited to around 50% of the Pnom. including in charger mode or Smart Boost mode.
4x	Battery voltage higher than the maximum limit set by the parameter {1121}.	Check the cause of this excess voltage. The equipment will restart automatically when the voltage falls below the threshold value {1122}. see sect. 7.4.1.2 – p. 28
5x	No transfer. Insufficient power from the source	In this case, the Xtender remains in operation in inverter mode until the output power decrease below the input limit and does not allow the transfer relay to close. You must increase the input current limit {1107}, or authorise the exceeding of this limit {1436} or authorise backup on the source {1126}, or disconnect some consumers (decrease of loads).
6x	Startup prevented due to unwanted voltage at the device output.	Voltage is present at the device output. Check your cabling: correct the fault and start the installation again using a manual control on the button (41).
7x	Indicates missing voltage on one of the units of the system in a multi-unit configuration.	Check the input protection devices (H) for all the system units.
8x	Software incompatibility in a multi-units system	The software version of all units in the system must be harmonised. Proceed according to the RCC-02/-03 user manual to upgrade the software.
9x	Loss of synchronization between the units	Failure of the link between the units. Check the presence and the state of the communication cables between units.

(43) This indicator is glowing continuously when the device is working. It flashes when the equipment is temporarily stopped due to a fault displayed by the indicator (42) or a ON/OFF control wired at the command entry ("Remote ON/OFF") (7), or when the equipment is put to idle mode by the master unit in a multi-inverter parallel system (see sect. 8.1.2 - p. 31).

	The equipment will restart automatically when the conditions that led to the temporary stoppage have gone away.
---	---

In the systems with multi-units in parallel, the indicator (43) blinks 2 times when the Xtender is temporarily stopped by the master unit of the concerned phase while this mode is authorized. {1547}.

(44) This indicator lit continuously when the charger is working and has not yet reached his absorption phase.

It flashes twice during the absorption phase and once during the floating phase.

If the Smart Boost mode has been activated, this indicator goes out temporarily when source backup is required by users (loads).

(45) This indicator lit continuously when an alternative voltage with correct values, either in frequency {1112-1505-1506}, or in voltage {1199} is present at the AC IN input of the device and the current limit set by the user has not been reached.

It flashes one time when the current limit at the input {1107} set by the user has been reached. In this case the charger current is reduced in order to guarantee priority supply to the users (see .sect. 7.2.2.2 p. 25).

If the Smart Boost mode (see sect. 7.2.2.4 – p.26) is used and the inverter is part of the user supply – therefore the battery is discharged – the “charge” indicator (44) will be glowing.

If the input current is exceeded nevertheless, and this exceed not permitted by parameter{1436}, the Xtender goes back to inverter mode (transfer relay open) and the indicator (42) will keep flashing as long as the user current exceeds the limit value of the input current {1107}.

If grid feeding is allowed {1127} this indicator is blinking 2 times while feeding.

(46) This indicator lit continuously when an alternative voltage of 230V is present at the equipment output. It flashes when the device is in “load search” mode according to sect. 7.1.1 – p. 24.

(47) Receipt button to stop the acoustic warning (XTM only). The duration of the acoustic alarm {1565} is factory settled to 0 sec (deactivated).

12 MAINTENANCE OF THE INSTALLATION

With the exception of the periodic checking of connections (tightening and general condition) the Xtender does not require any special maintenance.

13 PRODUCT RECYCLING

The model of the Xtender series conform to the European directive 2002/95/EC on hazardous substances and does not contain the following elements: lead, cadmium, mercury, hexavalent chrome, PBB or PBDE.

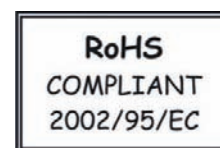

To dispose of this product, please use the service for the collection of electrical waste and observe all applicable obligations according to the place of purchase.

14 EC DECLARATION OF CONFORMITY

The inverter and accessories described in this manual comply with the following directive and standards:

Dir. 2004/108/EEC:

EN 61000-6-1, EN 61000-6-3, EN 55014, EN 55022, EN 61000-3-2, 62040-2,

LVD 2006/95/ EEC :

EN 62040-1-1, EN 50091-2, EN 60950-1.

1507 BA Zaandam, September 2010

Samlex Europe B.V.

M. van Veen

15 COMMENTS OF APPENDIX DRAWINGS

Fig.	Description and comment
1a	Dimensioning table for the downstream protection device (F). This table helps to size the Xtender upstream and downstream protection devices. Due to the source assistance function, it should be outlined that the downstream protection can be of higher gauge than the upstream one.
1b	Type plate and series no. See sect. 0 - p. 42 The intactness of this label is vital for any possible warranty claims. It must not be altered or removed.
2a	Dimensions and fastening the device The support (wall) must be appropriate for supporting the increased weight of the device without any risk.
5a	12 V battery: connection in series and in parallel / series for 2 V cell
5b	12 V battery: connection of 12 V battery in parallel
5c	24 V battery: connection in series and in parallel / series for 2 V cell
5d	24 V battery: connection in series and in parallel / series for 12 V battery block
6a	48 V battery: connection in series and in parallel / series for 12 V battery block
6b	48 V battery: connection in series for 12 V battery block
6c	48V battery: Series connection of 2V cell
6d	48 V battery: connection in parallel / series for 2 V cell
7a	Xtender XTS circuit diagram This diagram shows the major electrical components and control elements and their interaction in XTS model , for proper understanding of the operating principle of the device
7b	Xtender XTH/XTM circuit diagram This diagram shows the major electrical components and control elements and their interaction in XTH and XTM model , for proper understanding of the operating principle of the device
8a	Single-phase installation (AC and DC part) This example illustrates the most routinely used installation, allowing the attainment of an emergency system or a hybrid system (remote sites) ensuring the supply in single-phase from a generator and/or the battery when the AC source is absent. See also sect. 4.1.1– p. 14.
8b	Command entry variants (ON/OFF remote control) This example illustrates the various possibilities for connecting the entry command (remote ON/OFF on former version) terminal block (7), enabling to controls the programmed function (See also sect. 7.7 p.29.) with a dry contact or a voltage source (max 60V eff./30mA). The maximum wire length on this control should not exceed 10 m.
8c	Installation with three-phase source and secured single-phase output – AC and DC part In this example, the three-phase users will only be supplied when the generator or grid are operating.
9a	Fixed installation with plug connection to the single-phase source – AC part Special feature: The connection of the neutral upstream and downstream of the Xtender (C) is prohibited in this configuration (presence of a plug upstream). See also sect. 4.2 – p. 15.
9b	Fixed single-phase installation with connection by plug to a three-phase source – AC part Highlight(s): The connection of the neutral upstream and downstream of the 'Xtender (C) is prohibited in this configuration (presence of a plug upstream). See also sect. 4.2 – p. 15.
10a	Example of installation in a vehicle (AC part) Highlight(s): The connection of the neutral (C) is not permitted (presence of a socket upstream). The earth-neutral connection is absent in inverter mode (neutral stand-alone system). The safety is guaranteed by the equipotential bonding (frame). The automatic re-establishment of the earth-neutral connection downstream of the device in inverter mode can be programmed. Consult the table of figures, item (V). See also sect. 4.2.3 – p. 16.

Fig.	Description and comment
10b	<p>Example of installation in a boat without an isolation transformer (AC part) Highlight(s): Where there are multiple sources, for example connection to the dock and on-board generator, a source reverser (X) guaranteeing switching with phase and neutral interruption must be installed.</p>
10c	<p>Installation example in a boat, with isolation transformer Characteristic: With several power sources, like shore connection and onboard generator, a switchover (X) must be installed, to safely switch between the different voltage supplies with guaranteed interruption of the phase and neutral conductors. Moreover, an earth must be formed (E) after the isolation transformer.</p>
11	<p>Example of a hybrid installation: This is the most common system used to establish an emergency system or a hybrid system (grid-remote sites) ensuring a single-phase supply from a generator and/or the battery. Highlight(s): In a hybrid installation, the sources for recharging a battery (k-m) are connected directly to the batterie via their own regulator and their own protective device. This does not interfere with the Xtender charger.</p>
12	<p>Example of parallel connection of 2 or 3 Xtenders 1. Only Xtenders of the same power output may be connected in parallel. 2. Wiring precautions: The cable lengths and cross-sections of AC in input (A) and AC out output (B) must be the same for all inverters in parallel in the same phase. 3. Variant: The sum of the lengths of the cables (A1) + (B1) of Xtender 1 must be the same as the sum of the lengths of the cables (A1) + (B1) of Xtender 2, and ditto for Xtender 3 4. The AC input for each Xtender must be protected individually by a protection device (H) of the appropriate size but max. 50A (16A for XTS). 5. The protection device at the output of the Xtender (F) can be shared and of appropriate calibre at the sum of the currents of the devices in parallel. 6. In a multi-unit system, the functionality dedicated to the command entry (sect. 7.7 p. 29) must be the same for every unit. One unit only have to be wired and the function is applied to every unit of the system.</p>
13	<p>Example of three-phase cabling of 3 Xtenders – three-phase input Highlight(s): When 3 Xtenders are wired to form a three-phase grid, the wired phases at the input determine the jumper position for selecting the phase (10). It is vital to determine and select the phase for each Xtender. See also sect. 8.1.1 – p. 31. The comments for fig. 12 - 4 to 6 are valid.</p>
14	<p>Example of three-phase cabling of 3 Xtenders – single-phase input Highlight(s): In a three-phase configuration, if only one phase is available as a source, only one Xtender will be wired on that source. Phase 2 and 3 will be permanently fed from the two other units connected only to the battery (not connected to ACin). It is vital to determine and select the phase for each Xtender. The comments for fig. 12 are valid.</p>
15	<p>Example of three-phase, input and output wired, with reinforced phase Highlight(s): This installation allows a three-phase supply with a reinforced phase The reinforced phase may be incorporated on two or even three inverters in parallel. The protection device at the output on which 2 or 3 Xtenders are wired must be calibrated according to the sum of the maximum currents of the devices in parallel. The comments for fig. 12 to 13 are valid.</p>
16	<p>Example of cabling of 9 Xtenders in three-phase and parallel – AC part Special feature: In fixed high power installations, it is advised that a shared neutral be retained, distributed to all parties in the grid (see (C)) The comments for figs. 12 to 15 are valid.</p>
17	<p>Example of cabling of 9 Xtenders in three-phase and parallel – DC part (distribution bar)</p>
18	<p>Example of cabling of 9 Xtenders in three-phase and parallel – DC part in star formation</p>
19	<p>Connection of remote controls RCC-02/-03 At an Xtender or at a system with several Xtender maximally 3 remote controls can be attached.</p>

16 DRAWING'S ELEMENTS (DC SIDE)

Elem.	Description	Comment
a	RCC-02/-03 remote control	This device allows complete configuration of the installation as well as displaying the system behaviour. It is recommended but not necessary for the installation to function well. See sect. 9.1 – p. 32.
b	Battery	The battery capacity is constituted according to figures 5a to 6d based on the required voltage. Note: It is vital that the voltage and the polarity of the battery be checked before connecting to the inverter. An overload or incorrect polarity could seriously damage the Xtender. Correct dimensioning of the batteries is essential for trouble free operation of the system. See sect. 4.3.1 – p. 16.
e	Communications cable	Communications cable. Only an original cable supplied by Samlex Europe may be used. The total length of the communications cable must not exceed 100 m for 3 x RCC-02/-03 or 300 m for a single RCC-02/-03.
f	Protection devices	A fuse-type device, thermal circuit breaker or magnetic-thermal circuit breaker (see fig. 8a) must be installed on at least one of the two battery conductors. It will ideally be placed on the positive pole of the battery and as close as possible to this. The calibre of the device is selected according to the cable cross-section used. If the negative pole of the battery is not earthed, it must also be protected by such a device.
h	Distribution bar	Positive pole of the battery
j	Distribution bar	Negative pole of the battery
k	Wind-powered or/and micro-hydro generator	One or more wind-powered generators or/and micro-hydro with their own regulation system may be used to directly charge the battery. Its dimensioning does not depend on the Xtender and does not interfere with it.
m	Solar generator	One or more solar-powered generators with their own regulation system may be used to directly charge the battery. Its dimensioning does not depend on the Xtender and does not interfere with it.
r	Command Entry	A control device may be connected to the terminals (7) of the Xtender. See sect. 7.7 – p.29. On XTM and XTS this input is available on a separate (external) device RCM-10 (see sect. 9.3.1- -p. 33
t	BTS-01 temperature sensor	The sensor is placed in immediate proximity to the battery. If the installation comprises several Xtenders, a single sensor is connected to one of the units. See sect. 9.2 p.33

17 FIGURE ELEMENT'S (AC PART)

Elem.	Description	Comment
A	Input supply cable	The cross-section is defined by means of the maximum current at source and the protection device (H). In multi-unit systems, cables (A) of the same phase must have the same length and cross-section (see comment fig. 12-2/3).
B	Output supply cable	In multi-unit systems, cables (B) of the same phase must have the same length and cross-section (see comment fig. 12-2/3). The cross-section must be selected by means of the Xtender's output current given on the type plate and the protection device selected for the input (see fig. 1a).
C	Connection of the neutrals	See sect. 4.2 - p. 15. In a fixed installation where the neutral is connected to the earth at a single installation point upstream of the Xtender, it is permissible to carry out a connection of the neutrals in order to preserve an unchanged earthing system downstream, independent of the operating mode of the Xtender. The downstream protecting ground fault device. This connection (C) is not permitted if a socket is installed upstream of the Xtender.

Elem.	Description	Comment
D	Differential circuit breaker	A protection device can be installed downstream of the source (G or U) according to the local requirements and in compliance with the applicable regulations and standards.
E	Earth-neutral connection bridge	The neutral is earthed at a single point of the installation, downstream of the source and upstream of the protection device(s) at the default current (DDR). When several sources are available, each source must have an earthed neutral. If the source has to be retained with an isolated earthing system (IT) the applicable local provisions and regulations must be applied.
F	AC output protection devices for the Xtender	A protection device dimensioned in dependence of the cable cross-section used may be installed downstream of the Xtender (main circuit breaker before distribution). The cable cross-section is to be dimensioned according to the calculation table of maximum output current (fig. 1). The Xtender has an internal current limitation the value of which is stated on the type plate Fig. 1b (35).
G	Generator	The generator is dimensioned according to the requirements of the user. Its rated current will determine the adjustment of the parameter {1107} "maximum current of the AC source".
H	Protection devices at the Xtender input	The protection device at the input of the Xtender must be dimensioned according to the power output of the source at the cable cross-section used. It will not exceed a calibre equivalent to the input current "I AC in" given on the type plate of the unit Fig. 1b (35).
K	Connection plug / socket	If the Xtender is connected to an AC source by means of a plug, the connection cable must not exceed a length of 2 m, and the socket must remain permanently accessible. The socket will be protected by a protection device of appropriate calibre. The connection of the neutrals (C) is prohibited in this case.
S	Secured grid	Distribution to the users supplied by the grid or the generator when this is present or by the Xtender within the limit of its power output from energy stored in the battery. This distribution is carried out in conformity with the local standards and regulations.
T	Non-secured grid	Distribution to users supplied exclusively via the present grid or the generator. This distribution is carried out in conformity with the local standards and regulations.
U	Public grid	The connection to the public grid imposes adherence to the local standards and regulations at the responsibility of the installer. The installation should, in principle, be checked and approved by an official body.
V	Automatic earth-neutral connection	This connection is deactivated by default. It may be used in certain specific cases for automatically re-establishing the neutral system type TT (TNC, TNS, TNC-S) when the Xtender is in inverter mode. The activation is carried out via RCC-02/-03 remote control by configuration of the parameter {1485}. This operation may only be carried out by qualified personnel, under the responsibility of these personnel, and in conformity with the local standards and regulations. See 4.2.3- p.16
W	Galvanic isolator	This device (optional) is generally used to reduce the risk of electrolytic corrosion due to the direct current when a boat is connected at the dock.
X	Source reversing switch	When the installation has more than one supply source, it is necessary to install a switching device between the sources, simultaneously switching the neutral and the phase(s) of these sources. In all cases this device (manual or automatic) must guarantee interruption of the connected source before its connection to another source.
Y	Isolation transformer	This device (optional) prevents the risk of galvanic corrosion due to direct currents when a boat is connected at the dock.

18 MECHANICAL DIMENSION AND MOUNTING ELEMENT

Pos.	Description	Comments
25	Mounting hook-up for XTS	Delivered with the unit (without screws for wall affixing)
26	Mounting hook-up for XTH	
27	Access shutter to the top fastening screw	This flap should be resealed after tightening the screws to prevent intrusion of small animals that could damage the device

19 NAMEPLATE (FIG. 1B)

Pos.	Denomination	Description	Comments
30	Model	Model	
31	Pnom*/P30*	Rated power output / power for 30 minutes with external cooling fan ECF-01	Model XTS only
32	Pnom/P30	Rated power output / power for 30 minutes	
33	Udc Battery	Rated battery voltage (accepted input range)	
34	Idc Charge/inv/inv*	Maximum current in charger/nominal current in inverter/in inverter with external cooling fan for XTS model	
35	Uac In	Maximum current at input / output	See sect. 7.2 - 24
36	Iac In	Rated AC input voltage (input range)	See sect.7.2.2 – p.25
37	Uac Out	Rated output voltage in inverter mode (possible adjustment range in inverter mode)	When the transfer relay is activated, the ac output voltage is equivalent to ac input voltage
38	I AC Out Inv/Inv*/max	Maximum charger current	See sect. 7.2.2 – p. 25
39	SN:xxxxxxxx	Serial no.	
40	IPxx	Protection degree according to IEC 60529	

20 TABLE OF FACTORY'S (DEFAULTS) PARAMETERS SETTINGS

Param .N°.	Denomination / description	Units	Fact. value ²	Mod. value
1107	Maximum current of the AC source	A	⁴ STD	
1108	Under voltage of the empty battery	V/cell	1.93	
1109	Sub-voltage of the charged battery	V/cell	1.75	
1110	Restart voltage of the inverter after under voltage of the battery	V/cell	2	
1111	Automatic startup at power up	y/n	no	
1112	Inverter frequency	Hz	50/60	
1121	Maximum DC voltage for stopping the Xtender	V/cell	2.84	
1126	Source assistance (Smart Boost) permitted	y/n	no	
1127	Grid feeding allowed	y/n	no	
1138	Battery charge current	A	⁴ STD	
1139	Battery voltage correction according to the temperature	mV/°C/ cell	-5	
1140	Battery maintenance voltage	V/cell	2.27	
1143	Voltage 1 to allow a new battery cycle	V/cell	2.1	
1144	Duration of under voltage 1 to allow a new cycle	min.	30	
1145	Voltage 2 to allow a new battery cycle	V/cell	1.93	
1146	Duration of under voltage 2 to allow a new cycle	sec.	180	
1156	Battery absorption voltage	V/cell	2.4	
1157	Duration of absorption	h	2	
1159	Current at end of absorption	Adc	10	
1161	Minimum interval between absorptions	h	3	
1187	Sensitivity of the charge detection (100% approx.25W)	%	10	
1188	Number of pulse load reserach	--	1	
1189	Time interval between load search pulses	sec.	0.8	
1190	Duration of under voltage of battery before disconnection	min.	3	
1191	Dynamic compensation for under voltage	y/n	yes	
1194	Battery adaptive low voltage allowed	o/n	no	
1195	Max voltage for adaptive low voltage	V/cell	2.08	
1198	Time elapsing before transfer relay opens	sec.	8	
1199	ACin voltage causing the opening of the transfer relay	Vac	180/90	
1200	Immediate open critical threshold for the transfer	Vac	100/50	
1246	Auxiliary contact 1 activated by voltage 1 {1247} after delays {1248}	y/n	yes	
1247	Voltage 1 under which auxiliary contact 1 is activated	V/cell	1.95	
1248	Delays on voltage 1 to activate auxiliary contact 1	min.	1	
1249	Auxiliary contact 1 activated by voltage 2 {1250} after delays {1251}	y/n	yes	
1250	Voltage 2 under which auxiliary contact 1 is activated	V/cell	2	
1251	Delays on voltage 2 to activate auxiliary contact 1	min.	10	
1252	Auxiliary contact 1 activated by voltage 3 {1253} after delays {1254}	y/n	yes	
1253	Voltage 3 under which auxiliary contact 1 is activated	V/cell	2.05	
1254	Delays on voltage 3 to activate auxiliary contact 1	min.	60	
1255	Voltage for deactivation of Aux 1	V/cell	2.25	
1256	Delays on voltage {1255} to deactivate auxiliary contact 1	min.	60	
1258	Auxiliary contact 1 activated by power 1	y/n	yes	
1286	Output voltage	Vac	230/120	
1288	Dynamic compensation of the thresholds (AUX.1)	y/n	no	
1298	Increment step of the adaptive low voltage method	mV/cell	20	
1304	Number of battery under-voltages permitted before final stop	--	3	
1307	Reset voltage for adaptive correction	V/cell	2.2	
1309	Minimum ACin voltage to authorize battery charging	Vac	185/142	
1404	Period for counting battery under-voltages	sec.	0	
1432	Maximum ACin voltage to switch to inverter mode	Vac	270/135	

² The second value concerns the 120Vac ranges

21 TECHNICAL DATA

Model	XTS 900-12	XTS 1200-24	XTS 1400-48	XTM 1500-12	XTM 2000-12	XTM 2400-24	XTM 2600-48	XTM 3500-24	XTM 4000-48	XTH 3000-12	XTH 5000-24	XTH 6000-48	XTH 8000-48	
Inverter														
Nominal battery voltage	12V	24V	48V	12V		24V	48V	24V	48V	12V	24V	48V		
Input voltage range	9.5 - 17V	19 - 34V	38 - 68V	9.5 - 17V		19 - 34V	38 - 68V	19 - 34V	38 - 68V	9.5 - 17V	19 - 34V	38 - 68V		
Continuous power @ 25°C	650**/500VA	800**/650VA	900**/750VA	1500VA	2000VA			3000VA	3500VA	2500VA	4500VA	5000VA	7000VA	
Power 30 min. @ 25°C	900**/700VA	1200**/1000VA	1400**/1200VA	1500VA	2000VA	2400VA	2600VA	3500VA	4000VA	3000VA	5000VA	6000VA	8000VA	
Power 5 sec. @ 25°C	2.3kVA	2.5kVA	2.8kVA	3.4kVA	4.8kVA	6kVA	6.5kVA	9kVA	10.5kVA	7.5kVA	12kVA	15kVA	21kVA	
Maximum load	Up to short-circuit													
Maximum asymmetric load	Up to Pcont.													
* Load detection (stand-by)	2 to 25 W													
Cos φ	0.1-1													
Maximum efficiency	93%	93%	93%	93%		94%	96%	94%	96%	93%	94%	96%		
Consumption OFF/Stand-by/ON	1.1W/1.4W/7W	1.2W/1.5W/8W	1.3W/1.6W/8W	1.2W/1.4W/8W	1.2W/1.4W/10W	1.4W/1.6W/9W	1.8W/2W/10W	1.4W/1.6W/12W	1.8W/2.1W/14W	1.2W/1.4W/14W	1.4W/1.8W/18W	1.8W/2.2W/22W	1.8W/2.4W/30W	
* Output voltage	Pure sine wave 230Vac (+/- 2%) / 120Vac ⁽¹⁾													
* Output frequency	50Hz / 60Hz ⁽¹⁾ +/- 0.05% (crystal controlled)													
Harmonic distortion	<2%													
Overload and short-circuit protection	Automatic disconnection with 3 time restart attempt													
Overheat protection	Warning before shut-off - with automatic restart													
Battery charger														
* Charge Characteristic	6 steps: Bulk-Absorption-Floating-Equalization-reduced floating-periodic absorption													
* Maximum charging current	35A	25A	12A	70A	100A	55A	30A	90A	50A	160A	140A	100A	120A	
* Temperature compensation	With BTS-01 or BSP 500/1200													
Power Factor Correction (PFC)	EN 61000-3-2													
General data														
* Input voltage range	150 to 265Vac / 50 to 140Vac (1)													
Input frequency	45 to 65Hz													
Input current max. (transfer relay) / Output current max.	16A/20A			50A/56A						50A/80A				
Transfer time	<15ms													
Multifunction contacts	Module ARM-02 with 2 contacts, in option			2 independent switchover contacts (potential free , 16Aac/5Adc)										
Weight	8.2 kg	9 kg	9.3 kg	15 kg	18.5 kg	16.2 kg		21.2 kg	22.9 kg	34 kg	40 kg	42 kg	46 kg	
Dimension hxxw [mm]	110x210x310	110x210x310	110x210x310	133x322x466				133x322x466		230x300x500	230x300x500	230x300x500		
Protection index	IP54			IP20										
Conformity	Directive EMC 2004/108/EC : EN 61000-6-1, EN 61000-6-3, EN 55014, EN 55022, EN 61000-3-2, 62040-2 Low voltage directive 2006/95/EC : EN 62040-1-1, EN 50091-2, EN 60950-1													
Operating temperature range	-20 à 55°C													
Relative humidity in operation	100%			95% without condensation						Forced from 55°C				
Ventilation	Optional cooling module ECF-01			Forced from 55°C										
Acoustic level	<40dB / <45dB (without/with ventilation)													

* Adjustable value

** value with optional cooling fan module ECF-01

(1) With -01 at the end of the reference (I.e. XTM3500-24-01), means 120V/60Hz. Available for all Xtenders except XTH 8000-48

22 NOTES



www.samlex.com
www.samlex-solar.com