

X-CLARITY™

Tissue Clearing System

User Manual



The contents of this document may be changed in the future without advance notice.
All copyrights of this manual are owned by Logos Biosystems.
The X-CLARITY™ Tissue Clearing System is a laboratory electrical instrument for scientific research use only.
It is not a medical, therapeutic, or in vitro diagnostics device.



The WEEE (Waste Electrical and Electronic Equipment) symbol indicates that users of this instrument have the responsibility of returning and disposing of WEEE in an environmentally friendly manner. Follow the waste ordinances of your region for proper disposal provisions.



The CE mark indicates that this instrument conforms to all applicable European Community provisions for which this marking is required. Users must be aware of and follow the conditions described in this manual for operating the instrument. The protection provided by the instrument may be impaired if the instrument is used in a manner not specified by this manual.



Protective earth (Ground)

**FCC
COMPLIANCE**

This equipment has been tested and found to comply with the limits for a Class A digital device, pursuant to part 15 of the FCC Rules. These limits are designed to provide reasonable protection against harmful interference when the equipment is operated in a commercial environment. This equipment generates, uses, and can radiate radio frequency energy and, if not installed and used in accordance with the instruction manual, may cause harmful interference to radio communications. Operation of this equipment in a residential area is likely to cause harmful interference in which case the user will be required to correct the interference at the user's own expense.

Table of Contents

Table of Contents	1
Safety Information	2
Environmental Conditions for Operation	3
1. Introduction	4
1.1 Product Overview	4
1.2 Product Contents	5
1.3 Product Specifications.....	6
2. Product Description.....	7
2.1 X-CLARITY™ ETC Chamber.....	7
2.2 X-CLARITY™ ETC Controller.....	8
2.3 X-CLARITY™ Pump	9
2.4 X-CLARITY™ Reservoir	9
3 Setting Up	10
3.1 Installation	10
3.2 Start up.....	12
3.3 Voltage, Current, Temperature, and Switching Time Settings.....	13
3.4 X-CLARITY™ Pump Settings	14
4 Running.....	15
4.1 Sample Preparation	15
4.2 Electrophoretic Tissue Clearing Solution	15
4.3 ETC Running.....	16
5. Maintenance and Troubleshooting.....	19
5.1 Cleaning	19
5.2 Troubleshooting	20
5.3 Error Codes.....	21
6. Ordering Information	22
7. Purchaser Notification	23
7.1 Limited Use Label License: Research Use Only	23

Safety Information

Before using this instrument, read this manual carefully to ensure that you know how to operate it safely and correctly. Keep this manual in an easily accessible location for future reference. For safe and risk-free use of the **X-CLARITY™ Tissue Clearing System**, read the warnings and information provided. Use the instrument as specified.

1. Avoid electric shock while operating the instruments. Do not touch the components with wet hands.
2. Operate the instrument in the conditions described in the Environmental Conditions for Operation.
3. Wear proper personal protective equipment (PPE) when handling the Electrophoretic Tissue Clearing Solution to avoid exposure.
4. Use only components provided or authorized by Logos Biosystems.
5. Make sure that the input voltage is compatible with the X-CLARITY™ ETC Controller power supply voltage before use.
6. Use the power cord and AC adapter provided. Ensure that the power cord is firmly plugged into the X-CLARITY™ ETC Controller and the power source.
7. Turn the X-CLARITY™ ETC Controller on only after connecting the power cord to both the power source and the controller. Always turn the X-CLARITY™ ETC Controller off before disconnecting the power cord and/or moving the instrument.
8. Turn the power off before opening the X-CLARITY™ ETC Chamber.
9. Carefully monitor tube connections. Replace tubes if leakage occurs.
10. Always use the pump to fill or drain the X-CLARITY™ ETC Chamber. Do not pour liquids in or out directly.
11. Use the recommended volume of Electrophoretic Clearing Solution with the provided X-CLARITY™ Reservoir. Bubbles may overflow during the run otherwise.
12. Do not use organic solvents other than the Electrophoretic Clearing Solution described in this manual. Different solvents may cause permanent and irreparable damage.
13. If components emit smoke, disconnect the power cord immediately from the outlet and contact a service representative or Logos Biosystems.
14. Do not disassemble the components in any event. If a device is malfunctioning or broken, please contact a service representative or Logos Biosystems. Disassembling the components invalidates the warranty.

Environmental Conditions for Operation

Operating Power	100 – 120 VAC, 2.2 A / 200 – 240 VAC, 1.1 A
Frequency	50/60 Hz
Installation Site	Indoor use only
Operating Temperature	10 – 30°C
Maximum Relative Humidity	20 – 70%
Altitude	≤ 2,000 m
Pollution Degree	2

1. Introduction

1.1 Product Overview

In 2013, what many called one of the most important advances for neuroanatomy was published in the journal Nature. CLARITY, a new method developed by scientists at Stanford University, was found to produce structurally sound and transparent tissues that are ready for multiple rounds of antibody labeling and imaging. With the CLARITY method, the biomolecules in intact tissues are covalently linked to a sturdy hydrogel network, preserving molecular information and structural integrity. Lipid bilayers are broken up through electrophoresis in the presence of ionic detergents, leaving behind a stable and transparent tissue-hydrogel hybrid that is chemically accessible for molecular phenotyping. The CLARITY method has opened up a world of possibilities, from tracing neural circuitry to exploring the relationship between structure and function with a global perspective.

The original electrophoretic tissue clearing (ETC) chamber used platinum wires as electrodes and controlled the temperature of the chamber by using a water circulator with a high flow rate. Many researchers have since discussed the low efficiency of clearing in the original design in an online forum. Scientists trying to clear their own tissue samples have run into difficulties that range from constructing their own DIY clearing chamber to poor tissue clearing. Time, resources, and samples have been wasted.

Logos Biosystems has since licensed and independently developed the CLARITY technology to make significant improvements for tissue clearing efficiency and reproducibility. The **X-CLARITY™ Tissue Clearing System** is an all-in-one, easy-to-use solution for electrophoretic tissue clearing. Its unique design accelerates the removal of lipids from tissues in a highly efficient manner. The X-CLARITY™ ETC Controller works as both a power supply and temperature controller for the X-CLARITY™ ETC Chamber. Improved electrodes generate a uniform electric field that eliminates uneven voltages and currents. A built-in electric switching system allows users to change the direction of the electric current at pre-defined time periods. An active cooling system minimizes the probability of artifacts arising due to poor temperature control. A clearing buffer is continually circulated through the chamber for consistent buffering capacity, temperature control, and the elimination of electrophoretic byproducts. This advanced system ensures that tissue clearing occurs efficiently and rapidly.

The **X-CLARITY™ Tissue Clearing System** is easy to setup and easy to use. Complicated electrical and communicating wires are combined into a single cable in an integrated system for power supply and control. By simply pushing a few buttons, researchers can easily operate the **X-CLARITY™ Tissue Clearing System**. Specifically designed consumables make the process even more convenient.

1.2 Product Contents

The X-CLARITY™ Tissue Clearing System product package contains the following components:

Component	Quantity
X-CLARITY™ ETC Chamber	1 unit
X-CLARITY™ ETC Controller	1 unit
X-CLARITY™ Pump	1 unit
X-CLARITY™ Reservoir	1 unit
Multi-Cable	1 unit
Power Cord	2 units
Snap-Lock Connector Tube	1 unit
Peristaltic Pump Tube	1 unit
Container Holder for 1 Tissue Container	1 unit
Tissue Container	5 units
Electrophoretic Tissue Clearing Solution	12 x 1 L

Upon receiving the product package, please inspect its contents to ensure that all parts have been included and that no damage has occurred during shipping. The warranty does not cover damage that may occur during shipping and handling. Any damage claims must be filed with the carrier.

1.3 Product Specifications

1.3.1 X-CLARITY™ ETC Chamber

Instrument Type	Electrophoretic chamber
Dimensions (WxDxH)	176 mm x 128 mm x 154 mm (Internal chamber volume: 57 mm x 30 mm x 93 mm)
Weight	2.8 kg

Note: The electric power to the X-CLARITY™ ETC Chamber is provided by the X-CLARITY™ ETC Controller via the multi-cable.

1.3.2 X-CLARITY™ ETC Controller

Instrument Type	Power supply and control
Dimensions (WxDxH)	180 mm x 340 mm x 200 mm
Weight	5.1 kg
Applicable Power	AC100-240V, 50/60 Hz
Power Consumption	210 W (including the X-CLARITY™ ETC Chamber)

1.3.3 X-CLARITY™ Pump

Instrument Type	Peristaltic pump
Dimensions (WxDxH)	232 mm x 142 mm x 149 mm
Weight	2.4 kg
Speed	0.1-100.0 rpm
Speed Precision	0.1 rpm
Speed Adjusting	Membrane keypad continuous adjusting
Applicable Power	AC100-240V, 50/60 Hz
Power Consumption	30 W

Note: Please see the separately supplied user manual for more information.

1.3.4 X-CLARITY™ Reservoir

Material	Glass or plastic
Total Volume	2 L
Recommended Buffer Volume	1.2 L

2. Product Description

The X-CLARITY™ Tissue Clearing System consists of: 1) the X-CLARITY™ ETC Chamber; 2) X-CLARITY™ ETC Controller; 3) X-CLARITY™ Pump; and 4) X-CLARITY™ Reservoir (Figure 1).



Figure 1. Components of the X-CLARITY™ Tissue Clearing System.

2.1 X-CLARITY™ ETC Chamber

The X-CLARITY™ ETC Chamber is an electrophoretic device that applies an electric current to tissue samples placed in the chamber (Figure 2). New and improved electrodes produce a uniform electric field for better clearing. The X-CLARITY™ ETC Chamber inlet and outlet allow for buffer circulation, which eliminates the loss of buffering capacity during electrophoresis and reduces the risk of overheating. The X-CLARITY™ ETC Chamber also has an integrated cooling system to dissipate the heat generated during electrophoresis.

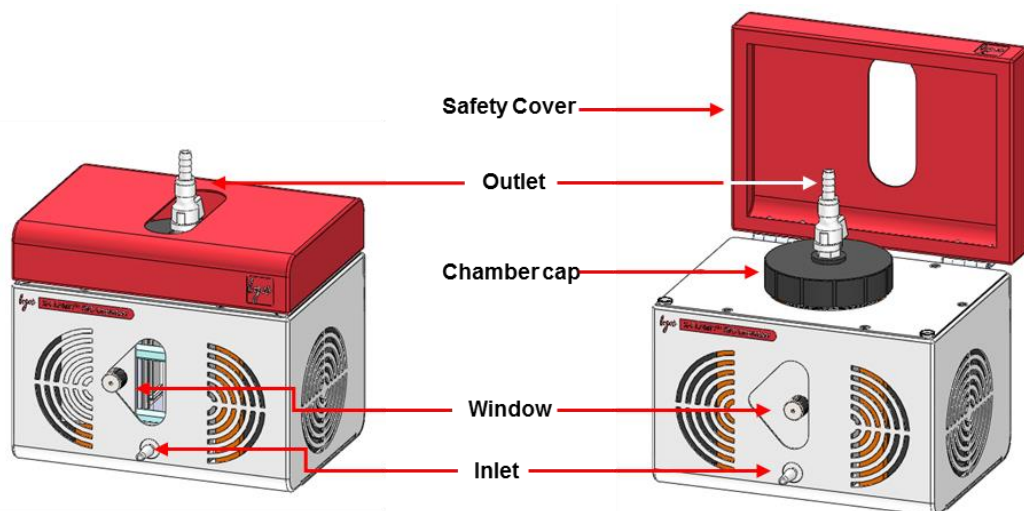

Figure 2. The X-CLARITY™ ETC Chamber.

2.2 X-CLARITY™ ETC Controller

The X-CLARITY™ ETC Controller is an integrated device that controls the power, temperature, and safety for the X-CLARITY™ ETC Chamber (Figure 3). No external devices are needed to supply power or control temperature when using the X-CLARITY™ ETC Controller.

The X-CLARITY™ ETC Chamber and the X-CLARITY™ ETC Controller are connected with just one cable, eliminating the need for dangerous and messy wiring.

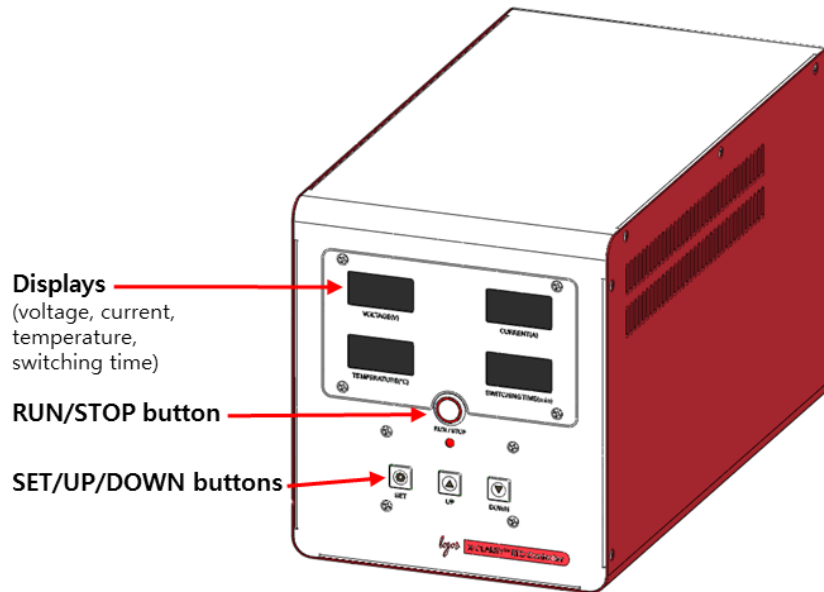

Figure 3. The X-CLARITY™ ETC Controller.

The control panel on the front of the X-CLARITY™ ETC Controller has buttons for adjusting the current, temperature, and switching time. Displays show the values of the voltage, current, temperature, and switching time (Figure 3). The **X-CLARITY™ Tissue Clearing System** only works in constant current mode and does not provide a constant voltage mode.

The X-CLARITY™ ETC Controller ranges are:

	Range	Increment
Voltage (V)	Not adjustable, max 60	N/A
Current (A)	0.2 – 1.5	0.1
Temperature (°C)	35 – 60	1
Switching time (min)	0 – 600	10

2.3 X-CLARITY™ Pump

The **X-CLARITY™ Tissue Clearing System** has the peristaltic X-CLARITY™ Pump. By circulating the buffer, the **X-CLARITY™ Tissue Clearing System** maintains consistent buffering capacity and controls the temperature in the X-CLARITY™ ETC Chamber. See the separately supplied pump user manual for more information.

2.4 X-CLARITY™ Reservoir

During the ETC process, it is important to circulate the Electrophoretic Tissue Clearing Solution to maintain buffering capacity, control buffer temperature, and remove bubbles from the X-CLARITY™ ETC Chamber. The **X-CLARITY™ Tissue Clearing System** comes with a 2 L bottle as a Reservoir. Due to water electrolysis and the presence of a detergent in the buffer, bubbles will come out of the chamber outlet. Start the process with 1.2 L of Electrophoretic Tissue Clearing Solution in the reservoir to maintain buffering capacity and prevent an overflow of bubbles. The temperature probe (attached to the reservoir cap) is inserted into the reservoir and connected to the X-CLARITY™ ETC Controller. The temperature of the clearing solution is displayed on the X-CLARITY™ ETC Controller.

3 Setting Up

3.1 Installation

Place the components of the **X-CLARITY™ Tissue Clearing System** on a clean and flat surface devoid of vibration. Leave sufficient space around the X-CLARITY™ ETC Chamber for the cooling fan to work properly.

Connect all tubes before running the system.

Note: *The tubes have a tubing life of 3000 hours*

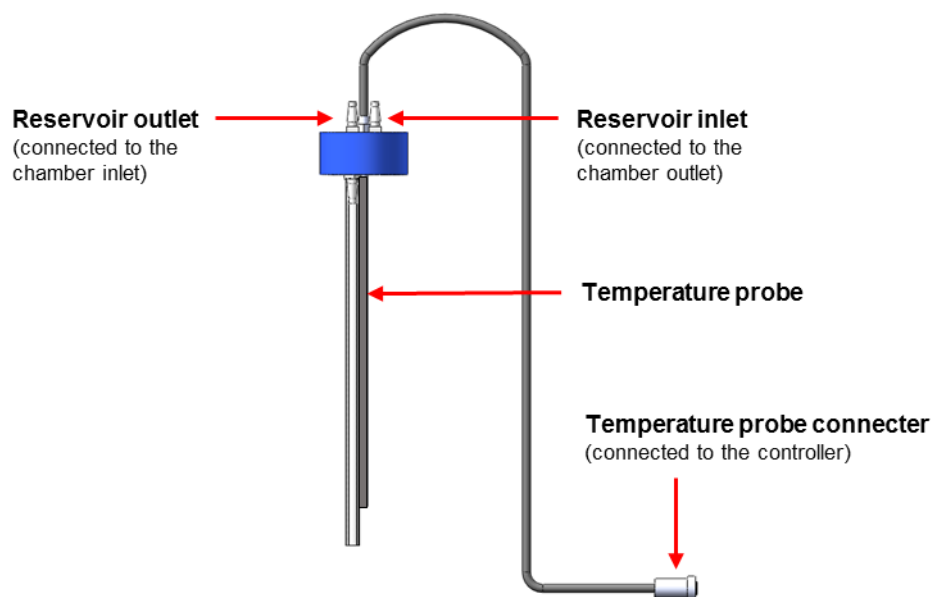

Figure 4. Diagram of the X-CLARITY™ Reservoir Cap.

Take the tube with two plain ends and connect one end to the reservoir outlet located on the cap of the X-CLARITY™ Reservoir. Run the middle of the tube in the head of the peristaltic pump. Attach the free end of the tube to the X-CLARITY™ ETC Chamber inlet.

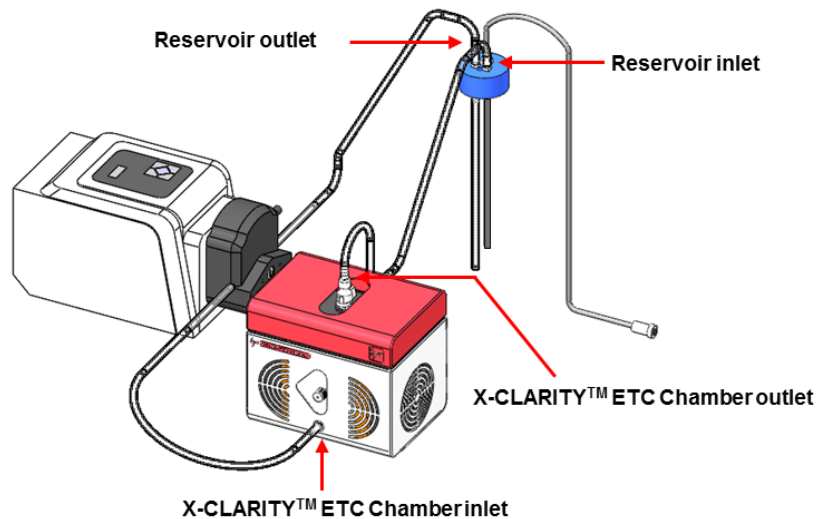

Figure 5. Connection of tubes.

Take the free end of the plastic snap-lock connector tube and attach it to the inlet located on the cap of the X-CLARITY™ Reservoir. Make sure the X-CLARITY™ ETC Chamber cap and safety cover are closed and then attach the snap-lock connector to the X-CLARITY™ ETC Chamber outlet. Do not attempt to open or close the X-CLARITY™ ETC Chamber safety cover when the snap-lock connector tube is attached to the X-CLARITY™ ETC Chamber outlet. Make the connections as tight as possible to prevent buffer leakage and make sure the tubes do not vent.

Note: Use the tubes provided by Logos Biosystems.

Connect the multi-cable to their ports on the rear panels of the X-CLARITY™ ETC Chamber and the X-CLARITY™ ETC Controller (Figure 6).

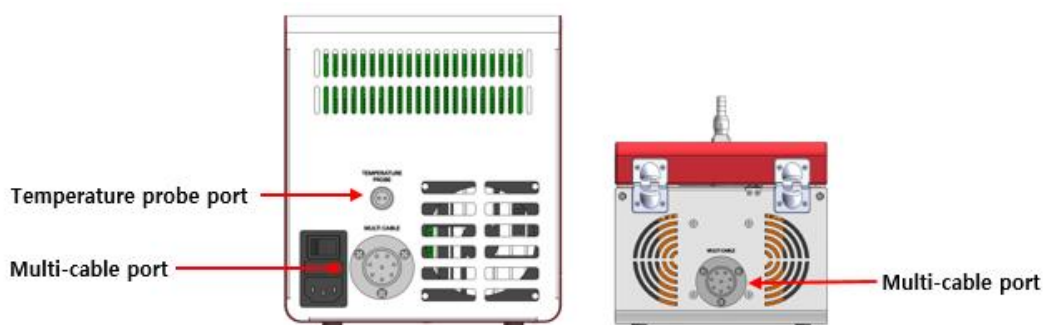

Figure 6. Cable ports.

Insert the temperature probe connector that projects from the cap of the X-CLARITY™ Reservoir into the temperature probe port on the rear panel of the X-CLARITY™ ETC Controller.

Connect the power cords to the X-CLARITY™ ETC Controller and X-CLARITY™ Pump.

3.2 Start up

Turn the power on by flipping the power switch on the rear panel of the X-CLARITY™ ETC Controller. When the X-CLARITY™ ETC Controller has been turned on, red numbers will appear on the displays and the cooling fan within the X-CLARITY™ ETC Chamber will begin to run. If not, check the power connection.

The front panel of the X-CLARITY™ ETC Controller consists of four displays for: 1) the voltage; 2) current; 3) temperature; and 4) switching time (Figure 7).

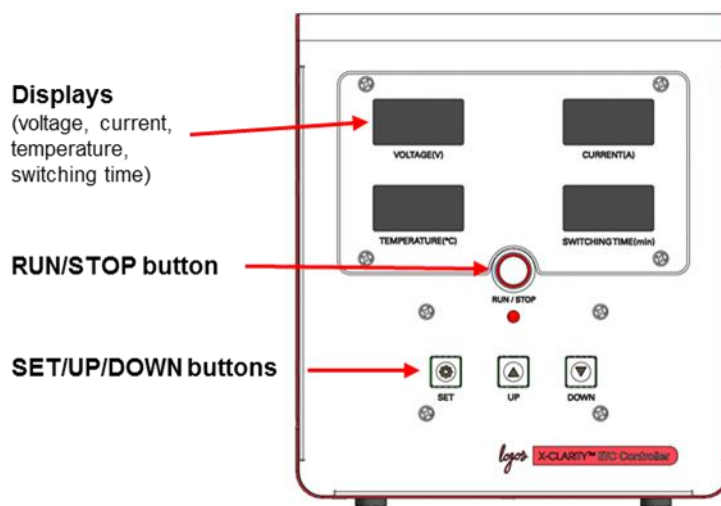

Figure 7. The display on the front panel of X-CLARITY™ ETC Controller.

A RUN/STOP button is located below the display panel (Figure 7). By pushing this button, the user can start or stop the ETC process.

The X-CLARITY™ ETC Chamber is equipped with a mechanical sensor to detect the opening and closing of the safety cover. If the cover is open, the bulb below the RUN/STOP button will blink red and the X-CLARITY™ ETC Controller will stop running.

Buttons for SET, UP, and DOWN are located on the lower half of the front panel (Figure 7).

3.3 Voltage, Current, Temperature, and Switching Time Settings

The X-CLARITY™ Tissue Clearing System only works in constant current mode and not in constant voltage mode.

Note: Many researchers and the original paper published in Nature have reported results obtained from using a constant voltage of 10–60 V. However, Logos Biosystems found that constant current mode leads to more consistent tissue clearing results. The recommended constant current value is 1.5 A. Changing the current value may affect the time and/or efficiency of clearing and require further optimization.

A built-in electric switching system allows users to change the direction of the electric current at pre-defined time periods.

To adjust values for current, temperature, or switching time, push the SET button located on the front panel of the X-CLARITY™ ETC Controller. The activated display will blink on in the following order when you continue to push the SET button: Current → Temperature → Switching time. Use the UP and DOWN buttons to adjust to the desired values. Push the SET button again to complete the setting.

The ranges provided by the X-CLARITY™ ETC Controller are:

	Range	Increment
Voltage (V)	Not adjustable, max 60	N/A
Current (A)	0.2 – 1.5	0.1
Temperature (°C)	35 – 60	1
Switching time (min)	0 – 600	10

The following are the recommended values to clear a whole adult mouse brain. At these settings, it takes about 48 hours to clear a whole adult mouse brain.

	Recommended
Current	1.5 A
Temperature	37-45°C
Switching time	0
Peristaltic pump speed	30 rpm

Note 1: The current and voltage are dependent on the resistance of the buffer. Depending on the condition of the Electrophoretic Tissue Clearing Solution, the initial current value may be lower than 1.5 A due to the voltage limit (60 V). If the X-CLARITY™ Tissue Clearing System does not reach 1.5 A after a few hours, please check the buffer.

Note 2: The tissue container holder design can also affect the resistance, which may lead to a decreased current value. Use the container holder provided.

3.4 X-CLARITY™ Pump Settings

The peristaltic pump included in the **X-CLARITY™ Tissue Clearing System** has a control panel as shown below.

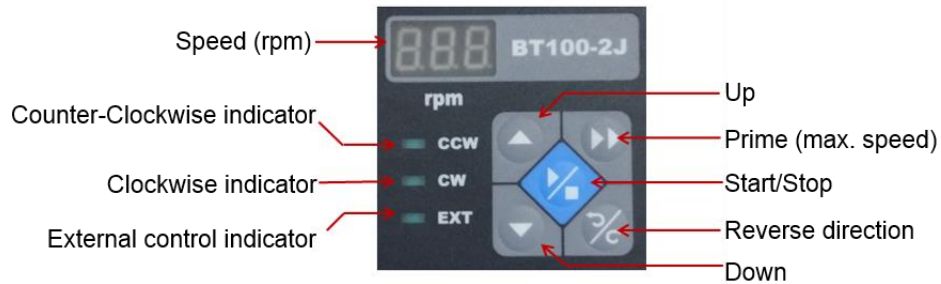

Figure 8. Control panel of X-CLARITY™ Pump.

When the **X-CLARITY™ Tissue Clearing System** is assembled, run the pump to supply buffer to the X-CLARITY™ ETC Chamber.

Depending on how the pump has been oriented in relation to the X-CLARITY™ ETC Chamber, run the pump in a clockwise (CW) or counterclockwise (CCW) direction to either supply or drain the chamber.

Start the pump at 30-50 rpm to begin circulating the Electrophoretic Tissue Clearing Solution. Press the PRIME (fast forward) button to run the pump at maximum speed. Set to 30 rpm when the X-CLARITY™ ETC Chamber has been completely filled. At 30 rpm, the pump moves about 200 mL per minute.

See the separately supplied pump manual for more details.

4 Running

4.1 Sample Preparation

To clear tissue samples, the hydrogel-polymerized tissue should be incubated in Electrophoretic Tissue Clearing Solution for at least 24 hours prior to the run. Residual acrylamide from insufficient buffer changes may cause an adverse reaction causing dark particles to precipitate in the tissue and/or electrodes.

***Note:** Longer incubation times in Electrophoretic Tissue Clearing Solution may reduce the time required for the ETC process.*

4.2 Electrophoretic Tissue Clearing Solution

The Electrophoretic Tissue Clearing Solution (Cat No. C13001) is made up of 200 mM boric acid, 4% (wt/vol) SDS (pH 8.5).

Do not reuse Electrophoretic Tissue Clearing Solution. Reused clearing solution may have lowered buffering capacity, which reduces clearing efficiency. Electrophoretic Tissue Clearing Solution should be replaced daily while the tissue is being cleared. Prolonged use of Electrophoretic Tissue Clearing Solution may cause electrolysis of the extracted lipids, turning the tissue yellow.

In general, the amount of Electrophoretic Tissue Clearing Solution needed for the **X-CLARITY™ Tissue Clearing System** is 1.2 L per adult mouse brain per day. Since it takes about 48 hours to clear a whole adult mouse brain with the **X-CLARITY™ Tissue Clearing System**, the total volume of Electrophoretic Tissue Clearing Solution needed is 2.4 L.

4.3 ETC Running

Use the X-CLARITY™ pump to fill the X-CLARITY™ ETC Chamber about half full with the Electrophoretic Tissue Clearing Solution. Always use the pump to fill or drain the X-CLARITY™ ETC Chamber. Do not pour the solution in directly.

Place the tissue sample into the tissue container and put the top on. Insert the tissue container into the hole of the container holder.

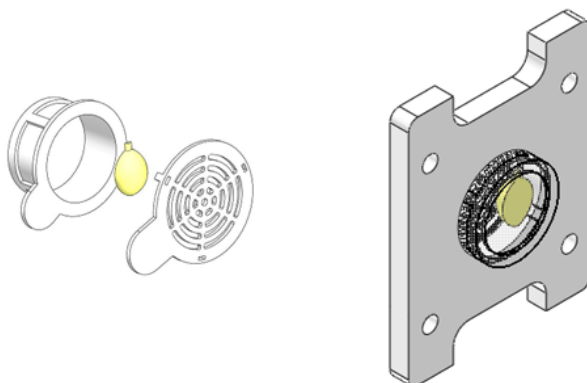

Figure 9. Tissue Container & Container Holder.

Place the container holder into the X-CLARITY™ ETC Chamber as shown in Figure 10.

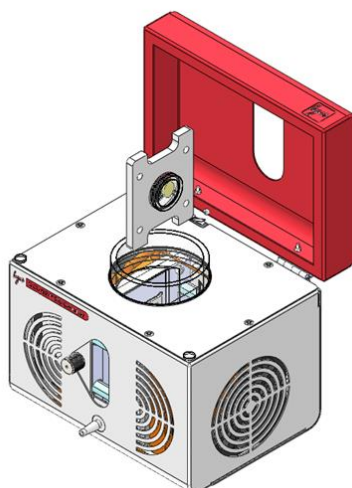

Figure 10. Insertion of the Container Holder into the X-CLARITY™ ETC Chamber.

Note: Do not fill the X-CLARITY™ ETC Chamber to the brim prior to sample insertion. This may cause the solution to overflow and potentially damage the X-CLARITY™ ETC Chamber. Start with just enough Electrophoretic Tissue Clearing Solution to cover the sample.

Screw on the chamber cap tightly. If the chamber cap has been fastened correctly, the silicone ring inside the cap will create a tight seal, preventing leaks. In case of leakage, please check the silicone ring inside the chamber cap.

Connect the snap-lock connector end of the silicone tube to the chamber outlet. NEVER open or close the X-CLARITY™ ETC Chamber safety cover when the tube is still attached to the chamber outlet. Disconnect the tube from the chamber outlet prior to opening or closing the safety cover by pressing the stainless steel button on the side of the snap-lock connector.

Make sure all the tubes are connected securely and properly. Turn on the peristaltic pump to 30-50 rpm to begin to circulate the Electrophoretic Tissue Clearing Solution. Adjust the flow rate of the pump to 30 rpm when the X-CLARITY™ ETC Chamber has been completely filled by circulation of the clearing solution.

Turn on the X-CLARITY™ ETC Controller and set the values for current, temperature, and switching time. To clear a whole adult mouse brain, use the parameters in the following table. To reduce time for the ETC process, adjust the switching time to 60 – 600 min. A shorter switching time usually means a shorter clearing time. However it also means more burden to the tissue. When using a short switching time, a proper end point (time) should be determined.

	Recommended
Current	1.5 A
Temperature	37-45°C
Switching time	0
Peristaltic pump speed	30 rpm

Push the RUN/STOP button on the X-CLARITY™ ETC Controller to start the ETC process. As the system runs, you will observe bubbles coming from the outlet. These bubbles are formed by the electrolysis of water.

Note 1: The X-CLARITY™ ETC Controller provides maximum 60 V and 1.5 A. In some cases, the current may not initially reach 1.5 A despite being set at 1.5 A. This can occur when the initial voltage exceeds 60 V. However, the current will stabilize to 1.5 A after a few hours of running.

Note 2: A significant amount of heat will be generated in the X-CLARITY™ ETC Chamber during the ETC process. To eliminate this heat, a cooler has been integrated into the X-CLARITY™ ETC Chamber. However, temperature control may not be efficient at a low setting value (ex. below 40°C) or high external temperatures. Cooling the Reservoir with an additional cooling system is helpful in such cases. Generally, it has been known that efficient clearing occurs at temperatures of 37-60°C.

Replace the Electrophoretic Tissue Clearing Solution every 24 hours. To change the Electrophoretic Tissue Clearing Solution, first stop the run by pushing the RUN/STOP button on the X-CLARITY™ ETC Controller. Check to see that the voltage and current values are at 0. Reverse the direction of the pump (CW to CCW OR CCW to CW). The draining of the solution can be observed through the window of the X-CLARITY™ ETC Chamber.

Note: *At this point, if the values of voltage and current do not drop to 0 after pushing the RUN/STOP button to stop the run, turn the power off by flipping the main power switch of the X-CLARITY™ ETC Controller. If the system does not recover when you turn on the power back on, please contact your local sales representative or Logos Biosystems.*

The tube connecting the X-CLARITY™ ETC Chamber outlet and the Reservoir outlet must be completely empty to prevent spilling when you disconnect the tube from the chamber outlet.

Stop the pump when the Electrophoretic Tissue Clearing Solution has been removed from the Chamber. Remove the snap-lock connector tube from the X-CLARITY™ ETC Chamber outlet, open the safety cover, and unscrew the chamber cap. Rinse the chamber with fresh Electrophoretic Tissue Clearing Solution if necessary.

Note: *Dark particles may appear on the electrodes or surface of the X-CLARITY™ ETC Chamber. These dark particles are carbon aggregates that are generated by electrolysis of organic materials. Use lint-free wipes to remove these particles as prolonged absorption of these particles may cause irreversible damage of electrodes.*

Refill the X-CLARITY™ ETC Chamber with the Electrophoretic Tissue Clearing Solution and continue the ETC process as described in pages 20-21.

Note: *The X-CLARITY™ ETC Chamber is equipped with a mechanical sensor to detect the opening and closing of the safety cover. If the cover is open, the X-CLARITY™ ETC Controller will stop running.*

5. Maintenance and Troubleshooting

5.1 Cleaning

Clean the X-CLARITY™ ETC Chamber after every run. The ETC process produces various byproducts such as tissue debris and carbonized particles. Wash the X-CLARITY™ ETC Chamber interior with fresh Electrophoretic Tissue Clearing Solution followed by deionized water after each run.

Note: Always use the pump to fill or drain the X-CLARITY™ ETC Chamber. Do not pour liquids into the X-CLARITY™ ETC Chamber directly.

Using the pump, fill the X-CLARITY™ ETC Chamber with 500 mL fresh Electrophoretic Tissue Clearing Solution.

Adjust the switching time of the X-CLARITY™ ETC Controller to “CL”. Set the temperature of the X-CLARITY™ ETC Controller to 37°C. Set the current to 1.5 A. Run the X-CLARITY™ Tissue Clearing system for 1-2 hours. Stop the system and drain the buffer.

Fill the reservoir with 1 L of deionized water and run the pump as you would during the ETC process. Press the prime button (maximum speed) to accelerate washing.

Use lint-free wipes to remove any residual particles after washing. Put a little water on the wipes and gently wipe the interior of the X-CLARITY™ ETC Chamber. Wipe gently. Rough and excessive handling may damage the X-CLARITY™ ETC Chamber.

Dry the X-CLARITY™ ETC Chamber thoroughly.

When cleaning the surfaces of the X-CLARITY™ ETC Chamber, do not use excessive amounts of water. Do not allow liquid to enter the device as this may cause electric damage. If liquid enters the device, do not turn the device on. Contact your local sales representative or Logos Biosystems.

5.2 Troubleshooting

Symptom	Possible Cause	Solution
Tissue is not clear	Inappropriate voltage and/or current applied	Check the voltage and current. If 40 V at 1.5 A is observed, it will take about 48 hours to clear a whole adult mouse brain.
	Low temperature	Set the temperature to 37– 50°C.
	Short clearing time	Run the system for longer.
	Inappropriate clearing solution	Use fresh Electrophoretic Tissue Clearing Solution.
	Incorrect pH	Use fresh Electrophoretic Tissue Clearing Solution (do not adjust the pH).
Tissue is dark	Insufficient polymerization of hydrogel	Perform polymerization of hydrogel with nitrogen under vacuum.
Tissue is yellow	Reused clearing solution	Change the Electrophoretic Tissue Clearing Solution with a cycle of 1.2 L/day for a whole adult mouse brain.
	More than one whole adult mouse brain per chamber	
	Reused tissue container	Use a new tissue container.
Tissue is distorted and/or deformed	Over-clearing	Reduce the time or current for the ETC process.
Displayed and set temperature are different	This is not unusual.	This is not unusual. In some cases, the displayed temperature may be above the setting value. Contact Logos Biosystems when the difference is more than 10°C.
High temperatures in the tube attached to the chamber outlet	Convection	Convection is a normal phenomenon. The temperature of the clearing solution in the tube will be ~5°C higher than indicated on the display

Symptom	Possible Cause	Solution
Leaking from the chamber cap	Improperly or loosely screwed on chamber cap	Screw on the chamber cap tightly. The silicone ring inside will prevent leaks.
	Aging of or damage to the chamber cap silicone ring	Replace the chamber cap. Please contact your local sales representative or Logos Biosystems.
Voltage and current values are 0 despite the settings	Open chamber safety cover	Close the cover.
	RUN/STOP button not pushed	Push the RUN/STOP button. A red halo around the button means the device is on.
	Other	This may be caused by malfunction of the controller. Please contact your local sales representative or Logos Biosystems.

5.3 Error Codes

Error code	Possible Cause	Solution
E01	Malfunction due to a defect of part	Reboot your system. If the error code persists, please contact your local sales representative or Logos Biosystems.
E02	Overheating due to high environmental temperature, a malfunctioning controller, or a malfunctioning cooling system	Set up your system in a cooler environmental temperature (less than 35°C). If the error code persists, please contact your local sales representative or Logos Biosystems.

6. Ordering Information

The following products can be ordered through your local sales representative or by contacting sales@logosbio.com.

Category	Cat #	Product	Unit
Starter Kit	C10001	X-CLARITY™ Tissue Clearing System Starter Kit	1 unit
	C10101	X-CLARITY™ ETC Chamber	1 unit
Main Components	C10201	X-CLARITY™ ETC Controller	1 unit
	C10301	X-CLARITY™ Pump	1 unit
	C10401	X-CLARITY™ Reservoir	1 unit
Containers & Holders	C12001	Tissue Container (20 units)	1 box
	C12002	Container Holder for 1 Tissue Container	1 unit
	C12004	Mouse Brain Slice Holder (Chamber Height: 4 mm)	1 unit
	C12007	Whole Rat Brain Holder	1 unit
Replacements	C12101	Multi-Cable	1 unit
	C12102	X-CLARITY™ Reservoir Cap with Temperature Probe	1 unit
	C12103	Snap-Lock Connector Tube	1 unit
	C12104	Peristaltic Pump Tube	1 unit
	C12201	Power Cord	1 unit
Solutions	C13001	Electrophoretic Tissue Clearing Solution	12 x 1 L
	C13101	X-CLARITY™ Mounting Solution	1 x 25 mL
	C13102	X-CLARITY™ Mounting Solution (Value Pack)	10 x 25 mL

7. Purchaser Notification

7.1 Limited Use Label License: Research Use Only

The purchaser of this product should use this product only for research for the sole benefit of the purchaser. By use of this product, the purchaser agrees to be bound by the terms of this limited use statement whether the purchaser is a for-profit or a not-for-profit entity.

If the purchaser is not willing to accept the conditions of this limited use statement and this product is unused, the Company will accept return of the product with a full refund.

The purchaser cannot re-sell or otherwise transfer (a) this product, (b) its components, or (c) materials made using this product or its components to a third party for Commercial Purposes.

Commercial Purposes mean any and all uses of this product and its components by a party for monetary or other consideration, including but not limited to, (a) product manufacture, (b) providing a service, information, or data, (c) therapeutic, diagnostic, or prophylactic purposes, or (d) resale of this product or its components whether or not such product and its components are resold for use in research.

Logos Biosystems, Inc. (“Company”) will not claim any consideration against the purchaser of infringement of patents owned or controlled by the Company that cover the product based on the manufacture, use, or sale of a therapeutic, clinical diagnostic, vaccine, or prophylactic product developed in research by the purchaser in which this product or its components were employed, provided that neither this product nor any of its components were used in the manufacture of such product.

For any use other than this limited use label license of research use only, please contact the Company or email info@logosbio.com for more information.

CLARITY™ is the registered trademark of Stanford University

X-CLARITY™ is the registered trademark of Logos Biosystems, Inc. (Patent pending)

7.2 Instrument Warranty

Logos Biosystems, Inc. (“Company”) warrants to the original purchaser (“Purchaser”) that the instrument (“Instrument”), if properly used and installed, will be free from defects in materials and workmanship and will conform to the product specifications for a period of one (1) year (“Warranty Period”) from the date of purchase. If the Instrument under this limited warranty fails during the Warranty Period, the Company, at its sole responsibility, will:

- 1) within and up to 30 calendar days of purchase, refund the purchase price of the Instrument to the Purchaser if the Instrument is in original conditions; or,
- 2) after 30 calendar days of purchase, only replace or repair the Instrument for up to the Warranty Period without issuing a credit.

In no event shall the Company accept any returned instrument (including its components) that might have been used or contaminated in some labs, including but not limited to, HIV or other infectious disease or blood-handling labs. This limited warranty does not cover refund, replacement, and repair incurred by accident, abuse, misuse, neglect, unauthorized repair, or modification of the Instrument. This limited warranty will be invalid if the Instrument is disassembled or repaired by the Purchaser.

In case that the Company decides to repair the Instrument, not to replace, this limited warranty includes replacement parts and labor for the Instrument. This limited warranty does not include shipment of the Instrument to and from service location or travel cost of service engineer, the costs of which shall be borne by the Purchaser. Every effort has been made to ensure that all the information contained in this document is correct at its publication. However, the Company makes no warranty of any kind regarding the contents of any publications or documentation as unintended or unexpected errors including occasional typographies or other kinds are inevitable. In addition, the Company reserves the right to make any changes necessary without notice as part of ongoing product development. If you discover an error in any of our publications, please report it to your local supplier or the Company. The Company shall have no responsibility or liability for any special, incidental, indirect or consequential loss or damage resulting from the use or malfunction of the Instrument.

This limited warranty is sole and exclusive. The Company makes no other representations or warranties of any kind, either express or implied, including for merchantability or fitness for a particular purpose with regards to this Instrument. To obtain service during the Warranty Period, contact your local supplier or the Company’s Technical Support team.

Out of Warranty Service

Please contact your local supplier or the Company’s technical support team in order to obtain out-of-warranty service. If necessary, repair service will be charged for replacement parts and labor hours incurred to repair the Instrument. In addition, the Purchaser is responsible for the cost of shipping the Instrument to and from the service facility and, if necessary, the travel cost of a service engineer.

Contact Information

For more information or technical support, please contact us. Our regional suppliers are listed on our website (www.logosbio.com).

Logos Biosystems, Inc.

Doosan Venturedigm Ste 930
415 Heungan-daero, Dongan-Gu
Anyang-Si, Gyeonggi-Do 431-755
South Korea

Tel: +82-31-478-4185

Fax: +82-31-478-4184

Email: sales@logosbio.com