

FCC STATEMENT

This device complies with Part 15 of the FCC Rules. Operation is subject to the following two conditions:

- (1) this device may not cause harmful interference, and
- (2) this device must accept any interference received, including interference that may cause undesired operation

Note: This equipment has been tested and found to comply with the limits for Class B digital devices, pursuant to Part 15 of the FCC rules. These limits are designed to provide reasonable protection against harmful interference in a residential installation. This equipment generates uses and can radiate radio frequency energy and, if not installed and used in accordance with the instructions, may cause harmful interference to radio communications. However, there is no guarantee that interference will not occur in a particular installation. If this equipment does cause harmful interference to radio or television reception, which can be determined by turning the equipment off and on, the user is encouraged to try to correct the interference by one or more of the following measures:

- Reorient or relocate the receiving antenna.
- Increase the separation between the equipment and receiver.
- Connect the equipment into an outlet on a circuit different from that to which the receiver is connected.
- Consult the dealer or an experienced radio/TV technician for help.

Use of shielded cable is required to comply with Class B limits in Subpart B of Part 15 of the FCC rules. Do not make any changes or modifications to the equipment unless otherwise specified in the manual. If such changes or modifications should be made, you could be required to stop operation of the equipment.

SAFETY PRECAUTIONS

- Do not use this DV camera if it is emitting smoke (or an unusual odor), becomes unusually hot to be touched, produces a peculiar noise, or exhibits any other abnormal conditions.
- Do not expose the DV camera to moisture and make sure no water gets into the DV camera.
- Do not touch the power plug during a thunderstorm if you are using the AC power adapter. This may cause an electrical shock.
- Do not use the DV camera if any foreign objects have entered the DV camera.
- Do not place the DV camera in an unstable location such as on a wobbly table or sloping surface.
- Do not insert or drop metallic or other foreign objects into the camera through access points such as the SD memory card slot.
- Do not attempt to modify this DV camera.
- Never operate this DV camera in any way while driving a vehicle.
- Do not cover or wrap the DV camera or the AC power adapter with a cloth or quilt. Always use the DV camera and its accessories in well-ventilated locations.
- Handle the DV camera carefully and do not bump the DV camera into any hard object.
- Do not move the DV camera while it is switched on. (If you are using the AC power adapter, unplug the adapter from the AC power outlet after you have switched off the camera.) Ensure that any connector cords or cables to other devices are disconnected before moving the DV camera.
- When leaving the DV camera unused for long periods, such as during a vacation, always unplug the DV camera from the power source (batteries or AC power adapter) for safety.

CONTENTS

INTRODUCTION..... 5-6

- Overview
- Package contents
- Optional accessories

GETTING TO KNOW YOUR DIGITAL VIDEO

CAMERA..... 7-12

- Front view
- Rear view
- LCD monitor information
- LED indicators and beeper
function

GETTING STARTED..... 12-16

- Installing the batteries
- Using the AC power adapter
(optional accessory)
- Attaching the strap
- Loading an SD memory card
(optional accessory)
- Turning on your digital video
camera

- Setting the date and time

CAPTURING IMAGES..... 16-21

- Basic Settings
 - Using the digital zoom
 - Using the Self-Timer
 - Using the Flash
 - Setting the image resolution and
quality
 - Number of recordable images

RECORD MODE..... 21-24

- Recording video clips
- Viewing video clips

PLAYBACK MODE..... 24-31

- Viewing images
- Zoom playback
- Displaying thumbnail images
- Slide show display
- Deleting video clips/images
 - To delete on video clip/image at
a time
 - To delete all video clip/image at

- once
- Protecting video clips/images
 - Protecting one video clip/image
 - Removing protection from One video clip/image

SYSTEM

CONNECTIONS 31-34

- Installing the USB Driver on a Windows PC
- Installing PhotoSuite
- Installing PhotoVista
- Installing WinDVD Creator SVCD

MENU OPTIONS 35-38

- Record menu
 - Image size
 - Image quality
 - Video quality
 - Exposure
 - White balance
 - ISO
 - Quick view

Setup Menus 39-44

- Format
- Beep

- Speaker
- LCD brightness
- Power off
- Reset to default
- Date type
- Date setup
- Date imprint
- Video out
- Light freq.
- Language

Playback Menu 44-46

- Protect
- Delete all
- Slide show
- Copy to card

CONNECTING YOUR DIGITAL VIDEO CAMERA TO OTHER

DEVICES 46

CAMERA

SPECIFICATIONS 47-48

APPENDIX 48

- Error messages

INTRODUCTION

Overview

Your new digital video camera delivers good quality, 1600 x 1200 resolution images using a 2.0 Mega pixels CMOS sensor. This digital video camera is designed as an “entry-level” handy cam. You can simply use this small DV camera for video recording.

Using the 1.5" LTPS color image LCD monitor, you can record images and then review them in detail. An auto-flash sensor automatically detects the shooting (lighting) conditions and determines whether the flash should be used. This feature helps ensure that your images turn out right.

64MB internal (built-in) memory let you capture and store images without the need for an additional memory card. However, you may wish to expand the memory capacity by using an external memory card.

Video clips or images that you have taken can be downloaded to your computer using the USB cable (USB driver is required for Win 98). You can enhance and retouch your images on your computer by using the provided editing software. You may share your images with your friends via e-mail, in a report, or on a website.

To play the video clip back on the computer, we recommend you to use Windows Multi-Media Player 9.0 (WMP 9.0). You can download free WMP version from the website at www.microsoft.com.

Package contents

Carefully unpack your kit box and ensure that you have the following items. In the event that any item is missing or if you find any mismatch or damage, promptly contact your dealer.

- | | |
|-----------------------------|-------------------|
| ■ Digital Video Camera | ■ USB cable |
| ■ AV cable | ■ Software CD-ROM |
| ■ User's manual | ■ Camera strap |
| ■ Quick guide | ■ Camera pouch |
| ■ 2 x AA alkaline batteries | ■ Camera Tripod |

Common (Optional) Accessories:

- SD memory card (up to 512MB capacity)
- AC power adapter

GETTING TO KNOW YOUR DIGITAL VIDEO CAMERA

Front view

1. Lens
2. Microphone
3. Flash
4. Self-timer LED
5. Battery/SD card cover
6. Tripod socket

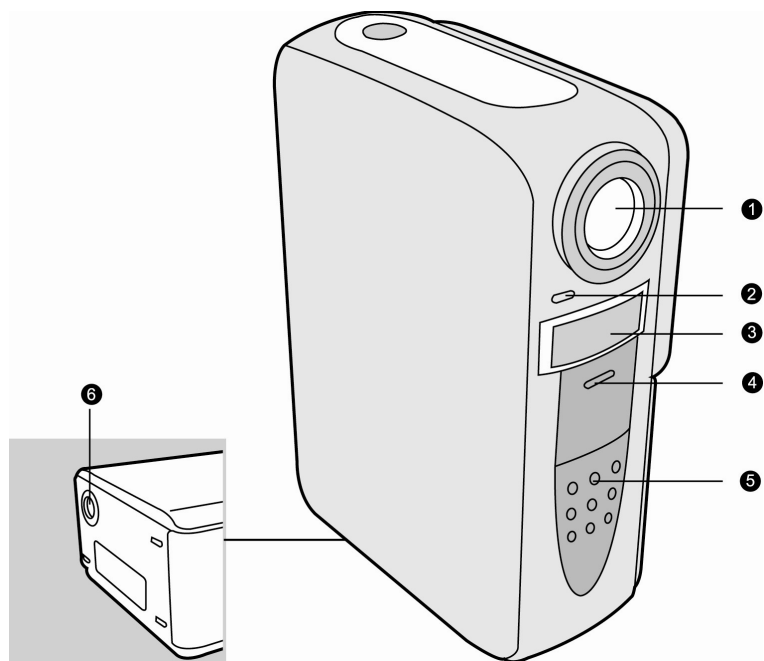

Back view

1. LCD monitor
2. Speaker
3. Power/Menu button
4. ▲ Arrow button (up)
5. ⚡ Flash button
6. ▶ Arrow button (right)
7. T Zoom in button
8. ▼ Arrow button (down)
9. ⌚ Self-timer button
10. ◀ Arrow button (left)
11. W Zoom out button
12. Record / Stop button
13. System LED indicator
14. OK OK button
15. 🔍 Digital zoom button
16. 📷 Image shutter button
17. 🗑️ Delete button
18. ▶ Playback button
19. ⏸️ Pause button
20. AV OUT (Audio/Video Out) terminal

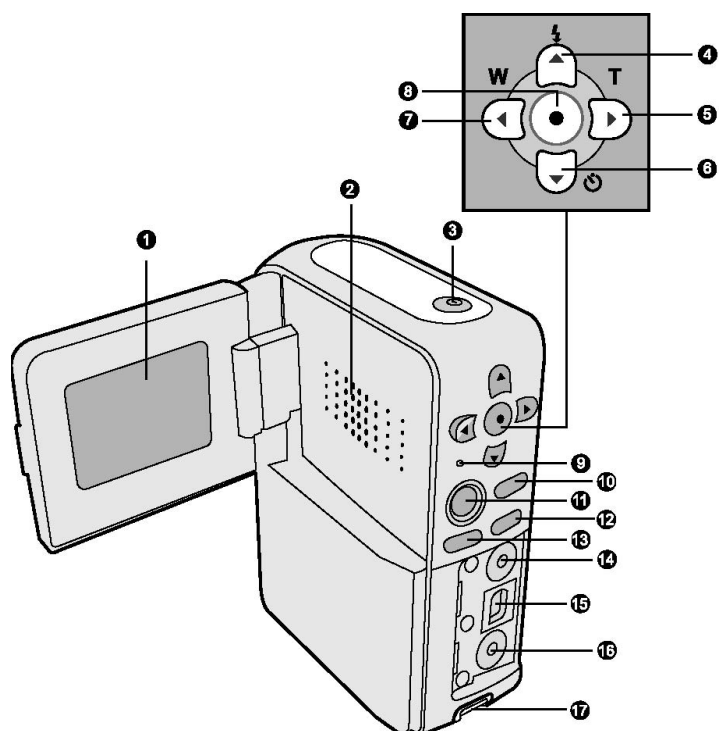

15. USB terminal
16. DC-in connector
17. Strap eyelet

LCD information

These indicators are displayed when recording still images or video clips:

1. Zoom state
2. Sound level
 - 🔊 Low sound level
 - 🔊🔊 Mild sound level
 - 🔊🔊🔊 Medium sound level
 - 🔊🔊🔊🔊 High sound level
 - 🔊🔊🔊🔊🔊 Fully sound level
 - 🔊 OFF Mute
3. Battery level
 - 🔋 Full battery power
 - 🔋 Fairly consumed
 - 🔋 Nearly exhausted
 - 🔋 Virtually no battery power
4. Card indicator
5. Flash mode
 - ⚡ Auto flash (intensive)
 - ⚡ Auto flash (extensive)
 - 🚫 Flash off
6. Self-timer indicator
7. White balance
 - ☀️ Daylight
 - ☁️ Shade
 - 💡 Fluorescent-1

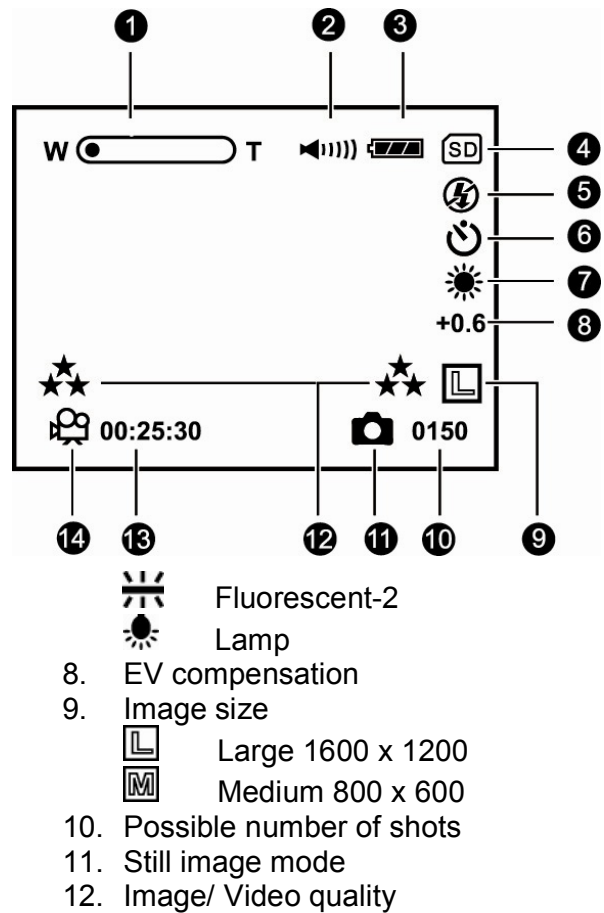

- ★★★ Super Fine
- ★★ Fine
- ★ Normal

- 13. Recordable movie time
- 14. Record mode

These indicators are displayed when playing back video clips:

- 1. Folder number and image number
- 2. Sound level

- 🔊 Low sound level
- 🔊🔊 Mild sound level
- 🔊🔊🔊 Medium sound level
- 🔊🔊🔊🔊 High sound level
- 🔊🔊🔊🔊🔊 Fully sound level
- 🔊 OFF Mute

- 3. Battery level

- 🔋 Full battery power
- 🔋 Fairly consumed
- 🔋 Nearly exhausted
- 🔋 Virtually no battery power

- 4. Card indicator

- 5. Pause / Play indicator

- 6. Count







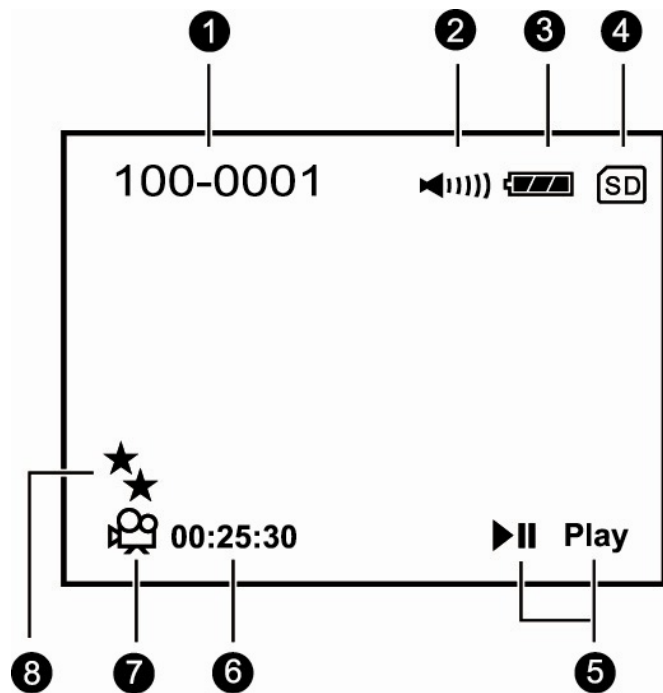

- 7. Record mode

- 8. Video quality

- ★★★ Super Fine
- ★★ Fine
- ★ Normal



These indicators are displayed when playing back still images:

1. Folder number and image number
2. Battery level
 -  Full battery power
 -  Fairly consumed
 -  Nearly exhausted
 -  Virtually no battery power
3. Card indicator
4. Date (year. month. day)
5. Exposure time
6. Aperture value
7. Still image mode
8. Image quality
 -  Super Fine
 -  Fine
 -  Normal
9. Image size
 -  Large 1600 x 1200
 -  Medium 800 x 600

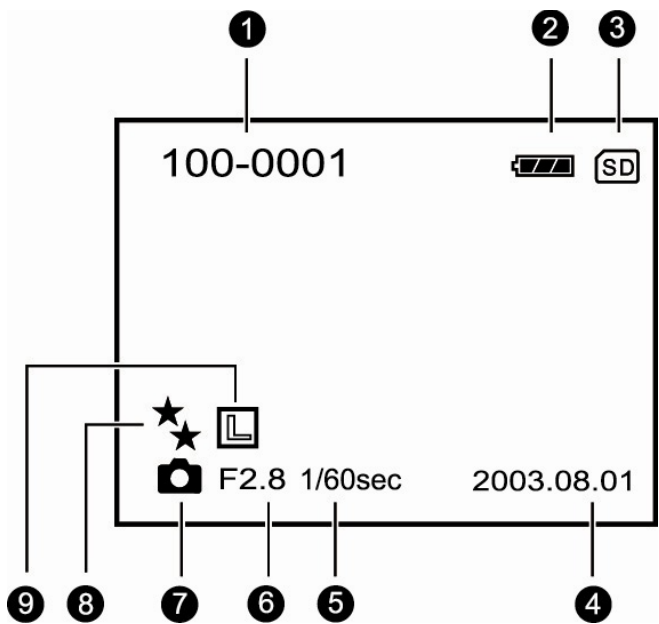

LED indicators and beeper function

Indicator	Status	Description/Activity	Sound
LED Indicator	Solid green	The camera is powering up	No

LED Indicator	Solid green	The camera is powered and ready	Yes *(1)
LED Indicator	Blinking red	Charging the flash	No
LED Indicator	Blinking green	Image is being recorded to the memory card	No
LED Indicator	Blinking green	USB communication/transfer in progress	No
LED Indicator	Solid green	The camera is ready to record images (or movies).	Yes *(1)
Self-timer Indicator	Blinking blue	The self-timer function is activated.	Yes *(1)
—	—	Error message	Yes *(3)
—	—	Valid button event	Yes *(1)

*(1) The camera sounds one beep.

*(3) The camera sounds three beeps.

GETTING STARTED

Installing the batteries

You can use either 2 AA size batteries (Alkaline, Ni-MH) or an AC power adapter (optional accessory) to power the camera. Battery power is convenient for capturing images or video clips while an AC power adapter is useful when transferring images to your computer.

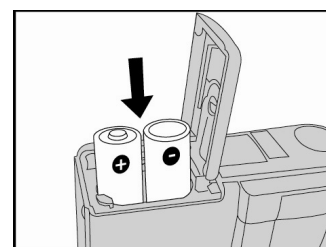

1. Slide the battery cover.
2. Insert the batteries, noting correct polarity (+ or -).
3. Close the battery cover firmly.

**NOTE**

- If you will not be using the batteries for an extended period of time, remove them from the camera to prevent leakage or corrosion.
- Never use manganese batteries.
- Never use batteries of different type (together) or mix old and new batteries.
- Avoid using batteries in extremely cold environments as low temperatures can shorten the battery life and reduce camera performance. (Such damage is not covered under the warranty).

Using an AC power adapter (optional accessory)

1. Connect one end of the AC power adapter to the jack labeled "DC IN".
2. Connect the other end to an electrical outlet.

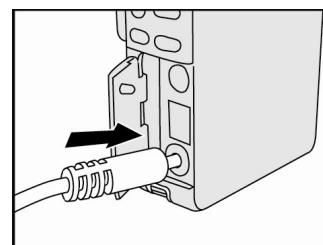
**NOTE**

- Make sure to use only the AC power adapter specified for the camera. Damage caused by the use of an incorrect adapter is not covered under the warranty.
- Using an AC power adapter while transferring images to your computer prevents unexpected automatic power off of the camera.

Attaching the hand strap

To prevent accidental dropping of the camera, always use the hand strap.

Attach the hand strap as follows:

1. Thread the small loop of the hand strap through the strap eyelet on the camera.
2. Pull the large loop through the small loop until the strap is firmly secured.

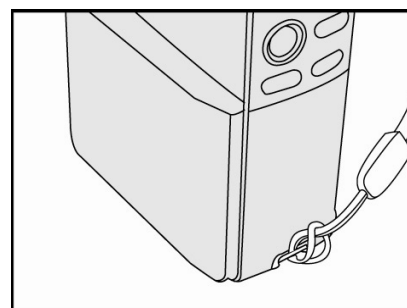

Loading an SD memory card (optional accessory)

The camera comes with 64MB of internal memory, allowing you to record video clips and store captured images in the camera. However, you can also expand the memory capacity by using an optional SD memory card so that you can store more images and video clips.

1. Slide the SD memory card cover.
2. Inset the SD memory card.
 - If the card cannot be inserted, check the orientation.
3. Close the SD card cover.

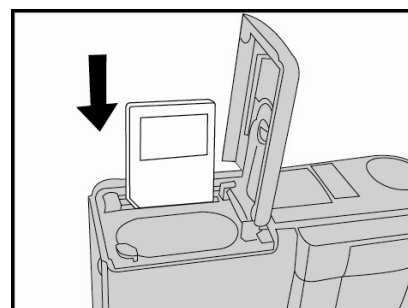

To remove an SD memory card

1. Make sure the camera is off.
2. Open the SD card cover.

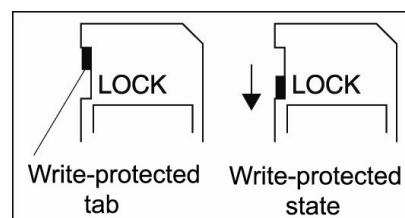



3. Press lightly on the edge of the memory card and it will eject.



NOTE

- To prevent valuable data from being accidentally erased from an SD card, you can slide the write protect tab (on the side of the SD memory card) to “LOCK”.
- To save, edit, or erase data on an SD memory card, you must unlock the card.

Turning on your digital video camera

1. Swing the LCD panel 90° away from the camera body.
2. Press and hold the  power/menu button on the top to turn on your camera.
 - To turn off your digital video camera, press again  power/menu button.



Setting the date and time

The date and time setting screen will automatically appear:

- When first turning the camera on;
- When turning the power on after leaving the camera without batteries for an extended period of time.

To adjust the date or time at any other time:

1. Press the **ⓘ** power/menu button.
2. Select **Setup** menu by using the **◀** or **▶** button.
3. Press the **▼** button to enter the main menu.
4. Select **Date setup** by using the **▲** or **▼** button, and press the **▶** button.
 - To increase the value for each option, press the **▲** button.
 - To decrease the value for each option, press the **▼** button.
 - Press the **▶** button to move to the next item field.
5. When all options are set, press the **OK** button.
6. To exit the menu mode press the **ⓘ** power/menu button again.

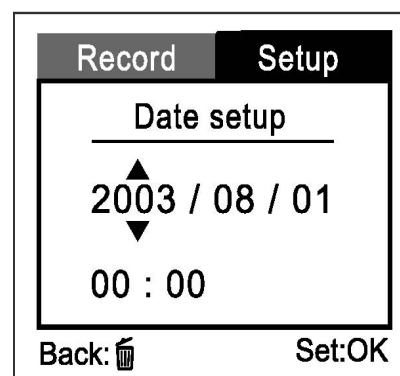

CAPTURING IMAGES

Basic settings

Using the digital zoom

Zoom photography allows you to capture telephoto and wide-angle shots. By using the digital zoom, images can be enlarged by pressing the **(T)** telephoto button so that the subject appears closer or appears further away by pressing the **(W)** wide-angle button.

1. Turn on your digital video camera.
2. Swing the LCD monitor.
3. Press the **T** telephoto button to activate the zoom function.
 - Digital zoom's range is from 1x to 2.5x.
 - The digital zoom magnification appears on the LCD monitor.
4. Use the (**T**) telephoto button or (**W**) wide-angle button to adjust the zoom state. The digital zoom level displays on the LCD monitor.
5. Press the  shutter button to record a "zoomed" video clip.

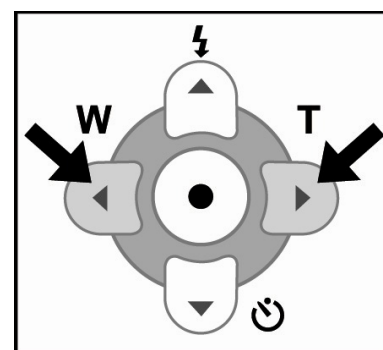
**NOTE**

- The more the image is enlarged, the more pixilated (grainier) the image.
- It is not possible to capture a zoomed image (photograph).
- In still image mode, the digital zoom's range is from 1x to 2.5x to help you to see the details of the image. However, the actual captured image will be stored as 1x ratio only.

Using the self-timer



Use the self-timer you can join into the screen when taking group shots.

The self-timer duration is 10 seconds. After the self-timer is set, the shutter automatically releases after 10 seconds.

The self-timer lamp starts blinking relatively slow for 7 seconds and then blinking rapidly for the last 3 seconds.

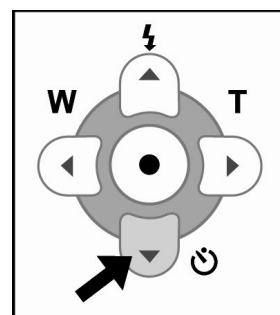
1. Secure your camera to a tripod or place it on a stable surface.





2. Press the  button to turn on your camera.
3. Compose the picture.
4. Press the  button.
 - The count down is displayed on the LCD monitor.
5. Press the  shutter button.
 - To cancel the self-timer photography at any time, press the self-timer again to disrupt the sequence.

**NOTE**

- After an image is taken by using self-timer, the self-timer mode is turned off.
- If you wish to take another image using the self-timer, repeat these steps.



Using the flash

The flash is designed to function automatically when lighting conditions warrant the use of flash. You can capture an image using a suitable flash mode to your circumstances.

1. Press the  button to turn on your camera.
2. Press the  button repeatedly until your desired flash mode appears on the LCD monitor.
3. Compose the picture and press the  shutter button.

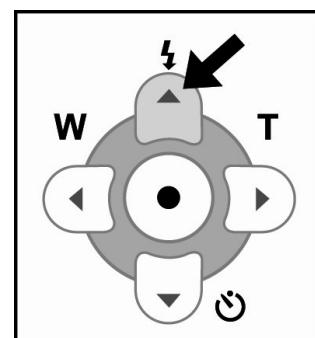
The camera has three flash modes: Auto flash (intensive), Auto flash (extensive) and Flash off.



Flash Mode	Description
 Auto Flash (intensive)	The flash fires automatically according to the ambient lighting conditions. Select this mode for general photography.
 Auto Flash (extensive)	The flash fires automatically according to the ambient lighting conditions. Select this mode for close photography.
 Flash Off	The flash will not fire. Select this mode when taking images in a place where flash photography is prohibited, or when the distance to the subject is beyond the effective range of the flash.













Setting the image resolution and quality

You can adjust the resolution and compression settings to suit the image you are about to shoot. The resolution gets higher in the order of 800x600 and 1600x1200. Use a higher resolution if you prefer a larger print. However, this will also produce larger file size.

The compression gets higher in his order of Super fine, Fine and Normal. Select Super fine for higher quality image, or Normal if you wish to capture more image. The Fine setting provides adequate quality for standard shots.

High resolution and quality settings are recommended for printed output and situations requiring the finest detail. Lower resolution/quality images take up less memory space and may be quite suitable for sharing images via e-mail, in a report, or on a web page.

To change image resolution and quality settings:

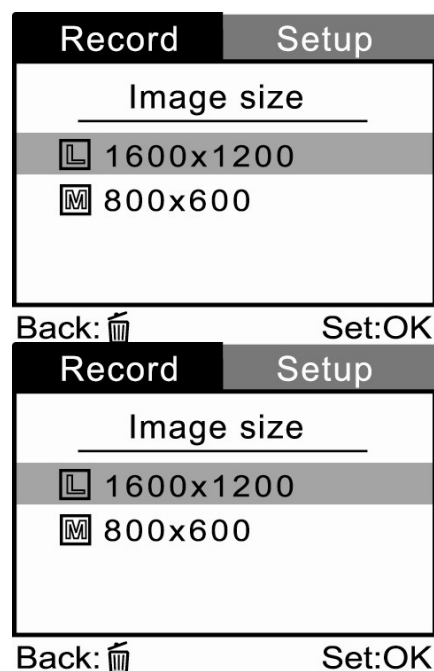

1. Press the  power/menu button and menu options pop up.
2. Select Record menu by using the  or  button.
3. Press the  button to enter the main menu.
4. Select **Image size** or **Image quality** by using the  or  button, and press the  button.
5. Change the settings with the  or  button and then press the  button.
6. Press the  power/menu button again to exit from the menu mode.
7. Compose your picture.
8. Press the  shutter button.



Number of recordable images

The frame counter indicates the approximate number of images that can be stored on the internal memory or the SD memory card at the camera's image quality and size settings. The



number of recordable images may vary depending on the recorded subject and the capacity of the memory card, or if there are files other than images, or when the recording is made while switching the picture quality or resolution.

Resolution	Quality	Compression ratio	64MB internal memory	64MB SD memory card
1600 x 1200 pixels 	Super fine	4:1	91	86
	Fine	8:1	136	129
	Normal	12:1	182	173
800 x 600 pixels 	Super fine	4:1	364	346
	Fine	8:1	546	519
	Normal	12:1	728	692

* The above data shows the standard testing results. The actual capacity varies according to shooting conditions and settings.

RECORD MODE



The digital video camera performs its best resolution of MPEG-4 320x240 pixels/ 25 fps.

1. Press the  power/menu button to turn on your camera.
2. To start recording a video clip by pressing the  record button.

- The zoom state, the battery level, card indicator (if an SD memory card is inserted), the movie mode and the elapsed time will display on the LCD monitor when recording a video clip.
- To stop recording, press the  record button again.



The table below indicates the approximate duration of recording time that you can record at each setting based on 64MB internal memory.

Resolution	Video Quality	Estimated Recording Time
320 x 240 pixels	 Super Fine	Approx. 5 min.
	 Fine	Approx. 12 min.
	 Normal	Approx. 17 min.











NOTE

- In record mode, zoom function is activated, and a “zoomed “video clip can be recorded.
- In record mode, video quality and self-timer cannot be set or activated.
- In record mode, the flash mode is automatically set to [Off].
- In record mode, the minimum environment’s luminance requires 110 lux at least.

Viewing video clips

To view the recorded video clips, follow the steps below:

1. Press the  power/menu button to turn on your camera.
2. Press the  playback/ pause button to view the recorded video clips.
3. Select the video clip you want to view by using the  or  button.
 - To pause playback at any time, press the  playback/ pause button again.
 - To stop playback, press the  button.

Pressing the  or the  button while playing the video clip will change the status as follows:

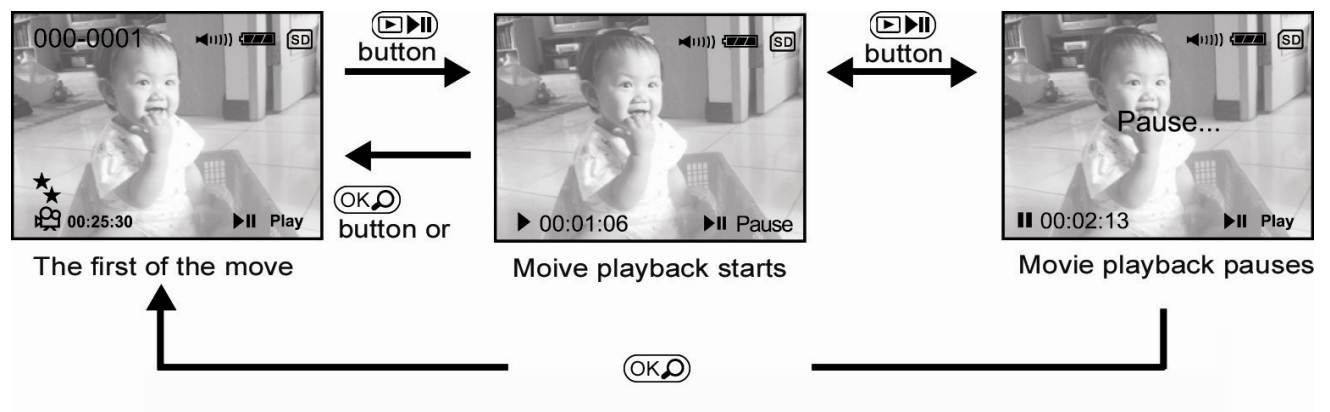



**NOTE**

- While viewing the recorded video clips, press **OK** button the screen will display thumbnail images.
- To play the video clip back on the computer, we recommend you to use Windows Multi-Media Player 9.0(WMP 9.0) or the Software Application we offered. You can download free WMP version from the website at www.microsoft.com.
- To adjust the sound level, press the ▲ button will increase the volume; press the ▼ button will decrease the volume.

PLAYBACK MODE

In the  playback mode, you can view, magnify, protect images, delete all images, or run a slide show. Playback mode also provides a thumbnail image display, allowing you quickly search for the image you want.

Viewing images

1. Press the  power/menu button to turn on your camera.
2. Press the  playback/ pause button to view the captured images.
3. Select the image you want to view by using the ◀ or

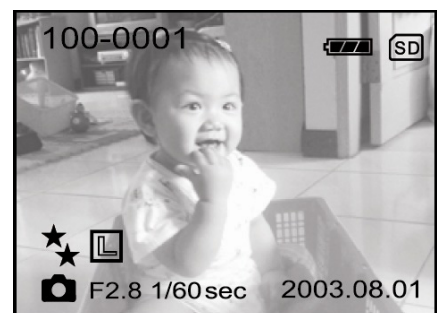

- ▶ button.
- To view the previous image, press the ◀ button.
- To view the next image, press the ▶ button
- The LCD monitor displays the detailed information for the captured image, such as image size, image quality, date, exposure time, aperture value, file number, card indicator (if the SD memory card is inserted) and the focus number.

**NOTE**



- You can also view your images on the TV screen. First connect one end of the A/V cable to the A/V OUT jack of the camera and the other end to the video input socket of the TV. The LCD monitor will be automatically off. Press the  button and then turn the TV and your camera on.

Zoom playback

While reviewing your images, you may enlarge a selected portion of an image. This magnification allows you to view fine details.

1. Press the  power/menu button to turn on your camera.



2. Press the  playback/ pause button.
 - The last image frame appears on the LCD monitor.
3. Use the ◀ or ▶ button to select the frame you want to enlarge.
4. Adjust the zoom ratio by using the  button.
 - The image is displayed enlarged; you will see a red frame with a red box inside. The red frame indicates the entire image, while the red box shows the location of the currently enlarged area.
5. Use the ▲ , ▼ , ◀ or ▶ button to select the area to enlarge.
6. To display the regular size, press the  button.

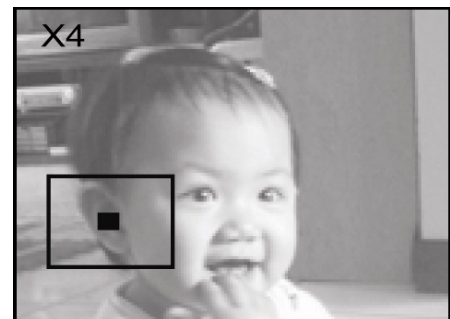









NOTE

- Press the **OK** button, the modes appear cyclically: 1x-> 2x-> 4x-> Thumbnail-> 1x .





Displaying Thumbnail images

This function allows you to view nine thumbnail images on the LCD monitor simultaneously so that you can quickly scan for a particular image.

1. Press the  power/menu button to turn on your camera.
2. Press the  playback/ pause button.
 - The last image frame appears on the LCD monitor.
3. Press the  button.
 - Nine thumbnail images appear on the LCD monitor (assuming there are nine or more recorded images in the memory).
4. Use the , ,  or  button to move the cursor to select the image to be displayed at regular size.
5. Press the  button to display the selected image on the full screen.















NOTE

- While displaying thumbnail images, press the  delete button, the screen will display “Delete this ?” you may choose [Yes] or [No] by using the  /  button. To confirm your choice, press the  button.

Slide show display

The slide show function enables you to play your images back automatically in sequential order as a slide show. This is a very useful and entertaining feature reviewing recorded images and for presentations.

1. Press the  power/menu button to turn on your camera.
2. Press the  playback/ pause button, then press again the  power/menu button.
3. Select Slide show by using the  or  button, and press the  button.
4. Set the playback interval by using the  or  button and press the  button.
 - The slideshow starts displaying your images on the LCD monitor, one by one, with the interval that you set.
 - To stop the slideshow display, press the  button.
 - To pause the slideshow display, press the  playback/ pause button.
 - To cancel the pause, press the  playback/ pause button.



NOTE









- You can adjust the slideshow display interval within the range of 1 sec. to 9 sec. For

slideshow interval, refer to “Slide show” in the Playback menu.



Deleting video clips/images

All files stored in the internal memory or SD memory card will be removed. To delete the video clip or image recorded in the internal memory, remember not to insert the memory card in the camera. Otherwise, the video clip or image recorded in the memory card will be erased.

To delete one video clip/image at a time

1. Press the  power/menu button to turn on your camera.
2. Press the  playback/ pause button to view the recorded video clips/images.
3. Select unwanted video clip/image by using the  or  button.
4. Press the  button.
5. “Delete this?” message appears on the image.
 - Use the  or  button to select [Yes], and then press the  button to confirm.
 - If you want to cancel the deletion, then select [No].
6. Repeat the above steps to delete further video clip/image if necessary. No images!] pops up.
 - If all video clips/images are deleted, [ No images!] pops up.

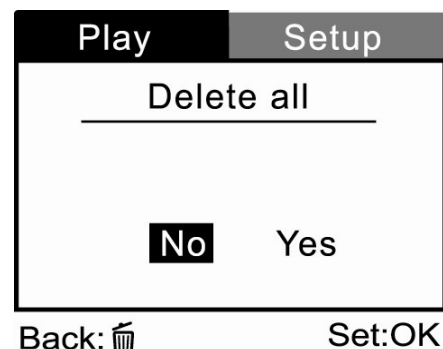

To delete all video clips/images at once

1. Press the  playback/ pause button to view the recorded video clips/ images.
2. Press slightly the  button and menu options



- pop up.
3. Select Playback menu play by using the ◀ or ▶ button.
 4. Select **“Delete all”** by using the ▲ or ▼ button, and then press the ▶ button.
 5. Use the ◀ or ▶ button to select [Yes], then press the  button to confirm.

A progress bar displays, indicating the progress of deleting.

- If you want to cancel the deletion, and then select [No].
- If all video clips/images are deleted, [ No images!] pops up.
- Turn back to the preview mode, press the  or  shutter/record button.

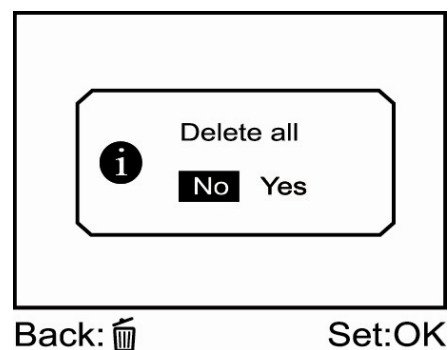









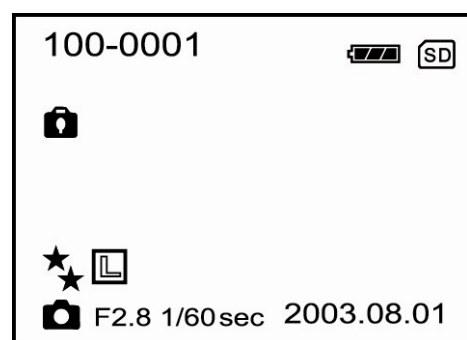





Protecting video clips/images

You can protect the video clips or images you prefer from being accidentally removed by selecting the protection function in the Playback menu. Follow the steps below to perform protect function:



Protecting one video clip/image

1. Press the  power/menu button to turn on your camera.



2. Press the  playback/ pause button, then press again the  button.
3. Select Protect by using the  or  button, and press the  button.
4. Use the  or  button to select "One image" and then press the  button.
 - To protect all images, select "All images" in this step.
5. Select "Lock" by using the  or  button and then press the  button.
 - Once the video clip/image is protected, the protection icon will display on the protected video clip/image.
 - To exit the playback menu, press the  or  shutter/record button.

Removing protection from one video clip/image

1. Perform the steps above 1 to 4 in "Protecting one video clip/image".
2. Select "Unlock" by pressing the  or  button and then press the  button to confirm.

SYSTEM CONNECTIONS

Installing the USB Driver on a Windows PC

The USB driver on the supplied CD-ROM is exclusively for Windows 98. Installing the USB driver on computers running Windows 2000/Me/XP is not necessary.

1. Insert the CD-ROM packaged with the camera into the CD-ROM drive. The welcome screen appears.
2. Click "Install USB Driver". Follow the on-screen instructions to complete the installation. After the



USB driver installation is complete, restart your computer.

Installing PhotoSuite

PhotoSuite is a very user-friendly image-editing program. With PhotoSuite, you can breezily retouch, compose and organize your images. It contains a variety of templates, such as photo frames, birthday cards, calendars and more. Get your images ready and go explore this amazing program.



To Install PhotoSuite

1. Inset the CD-ROM packaged with the camera into the CD-ROM drive. The welcome screen appears.
2. Click "Install PhotoSuite". Follow the on-screen instructions to complete the installation.



NOTE

- For information on how to use PhotoSuite to edit and retouch your recorded images, please refer to its online help.
- For Windows 2000/XP users, make sure to install and use the PhotoSuite while logged in as a user with an Administrator account.

To Install PhotoVista

PhotoVista is an easy-to-use program that lets you create spectacular 360 panoramic images in a snap. When you view these panoramas, you get the experience of being totally immersed in a realistic



environment. PhotoVista's powerful engine quickly and automatically stitches images together, and its intuitive interface will let even a novice get great results in minutes.

1. Insert the CD-ROM packaged with the camera into the CD-ROM drive. The welcome screen appears.
2. Click "Install PhotoVista". Follow the on-screen instructions to complete the installation.



NOTE

- For information on how to use PhotoVista to create spectacular 360° panoramic images, please refer to its online help.
- For Windows 2000/XP users, make sure to install and use the PhotoVista while logged in as a user with an Administrator account.
- For Windows XP users which OS version does not include Service Pack 1 or higher, be sure to link to <http://java.sun.com/getjava/download.html> first and download the Java Virtual Machine installation. For more detail information about Java, please refer to its on-line help at <http://java.sun.com/getjava/help.html>.

After java software installation, you can start to install iSee Media Photovista Panorama. Hereunder is iSee Media Photovista Panorama system requirements and recommendations: Windows 95/ Windows 98/ Windows NT 4 (Service Pack 3 or higher) Windows 2000*/ Windows Me*/ Windows XP* (Service Pack 1 or higher)

Install WinDVD Creator SVCD

WinDVD Creator is an easy-use software to help you to edit recorded video clips and make your own DVDs. WinDVD Creator lets you easily transfer your recorded videos from a camcorder, add picture, music, titles, transitions between scenes, special effects or edit the length you prefer.



This program also includes Automatic Scene Detection that automatically breaks up the video you transfer into both short clips and scenes.

To Install WinDVD Creator SVCD

1. Insert the CD-ROM packaged with the camera into the CD-ROM drive.
2. Click "Install WinDVD Creator SVCD" Follow the on-screen instructions to complete the installation.



WinDVD Creator System requirements:

Computer Part	Minimum	Recommended
Processor	Intel Celeron 800Mhz	Intel Pentium III 600Mhz *For Direct DVD Support, requires P4 1.6GHz higher for real-time requirement
RAM	128 MB	256MB
Operating System	Windows 98SE / 98 / Me / 2000 / XP	Windows 2000 / XP
Sound	On board AC'97 Codec	Windows compatible sound card that supports 48KHz playback (PCI recommended)
Video	On board Graphic Windows compatible PCI graphic card (overlay support is recommended)	Windows compatible AGP or PCI graphic card (overlay support is recommended)
Hard Drive	* 70 MB got installation * 620MB for every hour of VCD quality MPEG-1 video * 2 GB for every hour of DVD quality MPEG-2 video	
Other	CD or DVD burner required for VCD and DVD burning. Appropriate hardware need to import video from external sources like DV cameras and camcorders.	

Menu Options

Record Menu

You can use the Record menu to select image size, image quality or video quality. You can also adjust exposure, white balance or ISO speeding in the Record menu. The Record menu even allows you to enable quick view function.

To access the Record menu, press the  button. And scroll through the menu options by using  or  button.



Record menu items: Image size, Image quality, Video quality, Exposure, White balance, ISO and Quick view.

Record	Setup	Record	Setup
Image size		ISO	Auto
Image quality	★	Quick view	Off
Video quality	★★		
Exposure	0 EV		
White balance	Auto		

Exit: MENU Change:▶ Exit: MENU Change:▶

Image size

Set the desired image size.

-  1600 x 1200
-  800 x 600

Record	Setup
Image size	
	1600x1200
	800x600

Back:  Set:OK

Image quality

Set the quality (compression ratio) sharpness at which the image is to be recorded.

- ★★★ Super fine
- ★★ Fine
- ★ Normal

Video quality



Set the quality (compression ratio) sharpness at which the video clip is to be recorded.

- ★★★ Super fine
- ★★ Fine
- ★ Normal

Exposure

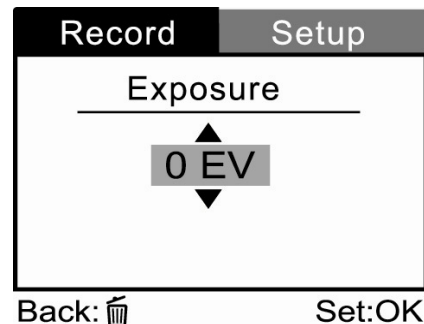
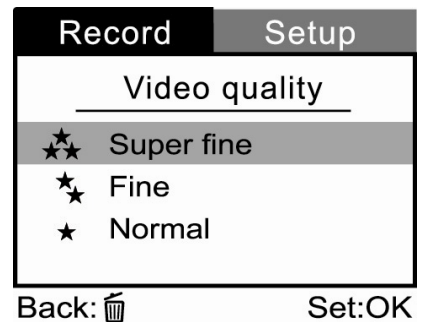
Your DV camera adjusts the exposure of each scene automatically. However, if the subject is very dark, or very bright, you may override the DV camera automatic exposure determination to make the subject brighter or darker. This is called EV compensation. The EV compensation of the DV camera can be adjusted from -1.8EV to +1.8EV in 0.3EV step.



To select the EV compensation you wish, first press the  button. Then increase or decrease the EV compensation depending on what you need by using the  or  button, then press button to confirm.

Effective Subjects and Set Values





Positive (+) Compensation

- Copying of printed text (black characters on white paper)
- Backlit portraits
- Very bright scenes (such as snowfields) and highly reflective subjects
- Shots made up predominantly of sky

Negative (-) Compensation

- Spot lighted subjects, particularly against dark backgrounds
 - Imaging of printed text (white characters on black paper)
- Scenes with low reflectivity, such as shots of green or dark foliage

Auto: Automatic adjustment

- [] Daylight: For recording outdoors on a bright day
- [] Shade: For recording outdoors on a cloudy day
- [] Fluorescent-1: Cool white fluorescent (W3900-4500K)
- [] Fluorescent-2: Day white fluorescent (W4600-5400K)
- [] Lamp: For recording under lamp light

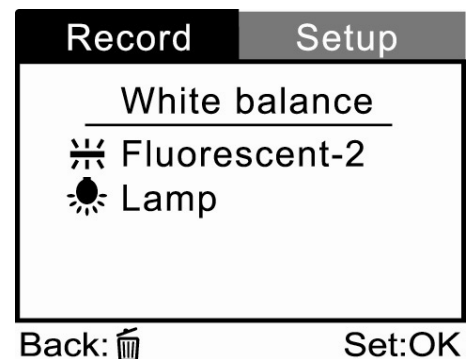

ISO

Select the photographic ISO to be used when a photograph is taken. The higher the ISO sensitivity value, the greater sensitivity, but the greater the noise. With a higher sensitivity selected, bright photographs can be taken with less light.

To set the ISO speed, first press the **▶** button. Then choose the ISO speed you prefer by using the **▲** or **▼** button, then press **OK** button to confirm.

- [Auto]** : Auto adjustment
- [100]** : Sensitivity equivalent to ISO100
- [200]** : Sensitivity equivalent to ISO200
- [400]** : Sensitivity equivalent to ISO400

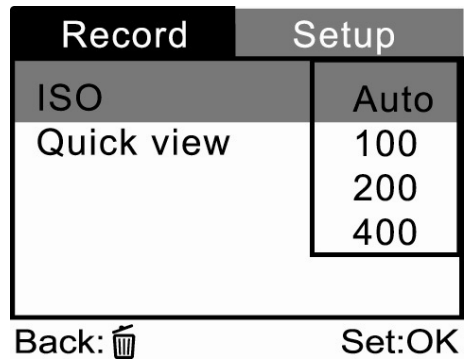

Quick view

Set to display a photographed image on LCD monitor immediately after you have taken the shot.

To set the quick view, first press the **▶** button. Then select **[On]** or **[Off]** by using the **▲** or **▼** button, then press **OK** button to confirm.

- [On]** : Display quick view
- [Off]** : Do not display quick view

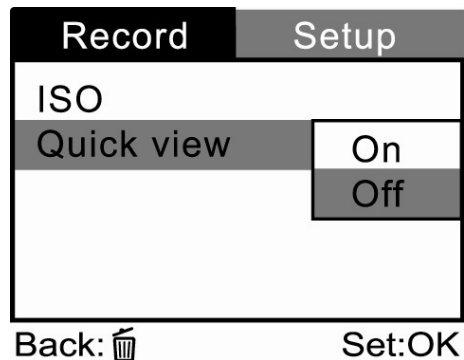

Setup Menu

You can select your preference for the DV camera settings in Setup mode. Press the **ⓘ** power button and navigate to the option you wish to configure by using the **▲** or **▼** button.

Setup menu items: Format, Beep, Speaker, LCD brightness, Power off, Reset to default, Date type, Date setup, Date imprint, Video out, Light freq. and Language.

Record	Setup	Record	Setup	Record	Setup
Format		Reset to default		Light freq.	50Hz
Beep	On	Date type	Y/M/D	Language	
Speaker	5	Date setup			
LCD brightness	0	Date imprint	On		
Power off	Cancel	Video out	NTSC		

Exit: MENU Change:▶ Exit: MENU Change:▶ Exit: MENU Change:▶

Quick view

This option formats the internal memory (or SD memory card) and erases all stored images and data.

To perform the format function, first press the **▶** button.

Then select [No] or [Yes] by using the **▲** or **▼** button, then press **OK** button to confirm. A progress bar displays, showing the progress of

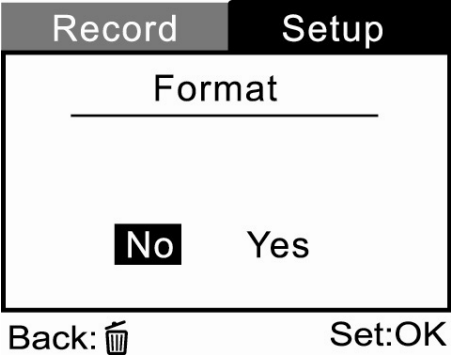

formatting.



[No] : Does not format the internal memory/SD card

[YES] : Formats the internal memory/SD card and erase all images

Beep

The DV camera makes a sound (beep) each time you press the camera button if this function is enabled.

Press the  button.

Select [On] or [Off] by using the  or  button, then press  button to confirm.



[On] : Enable beeper

[Off] : Disable beeper

Speaker

Set the play sound function.

To set the play sound level, first press the  button.

Then increase or decrease the sound depending on what you wish by using the  or  button, then press  button to confirm. The play sound level can be adjusted from 0 to 5.

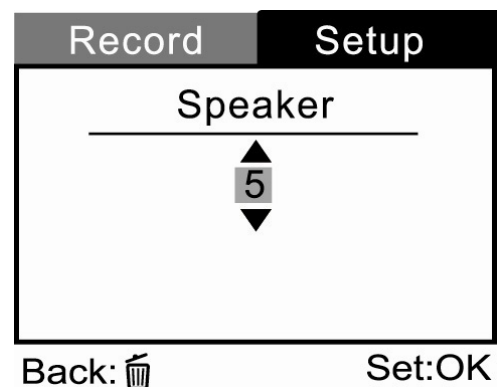
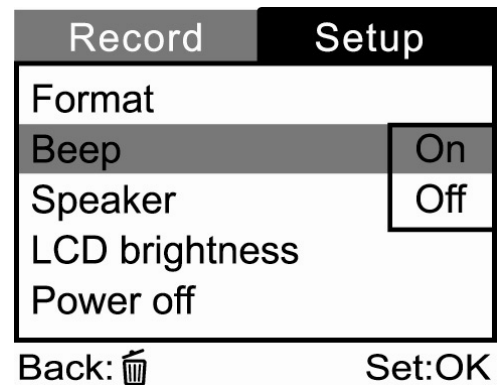

LCD brightness

This option adjusts the brightness of the LCD monitor. To adjust the LCD brightness, first press the ► button. Then increase or decrease the LCD brightness by using the ▲ or ▼ button, then press  button to confirm. The adjustment is from -5 to +5.

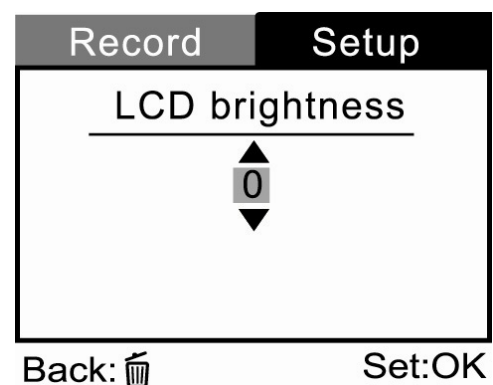

Power off





If the DV camera goes unused for a certain period of time while the camera is powered on, the DV camera will switch to an idle mode, and eventually turn itself off to conserve power.

Inactivity period (Batteries)	Inactivity period (AC Power Adapter)	Camera Status
60 seconds	60 seconds	Stay idle
3 minutes	30 minutes	Shut off

If the camera is idle, re-activate the camera by pressing any button or rotate the mode dial. If the camera has powered-off then you must turn the camera on again by pressing the  power button. To change the power saving interval when the camera is charging with batteries, first press the ► button. Then select the power-off interval you prefer by using the ▲ or ▼ button

and then press  button to confirm. [3 min], [5 min], [10 min], [30 min], [Cancel]



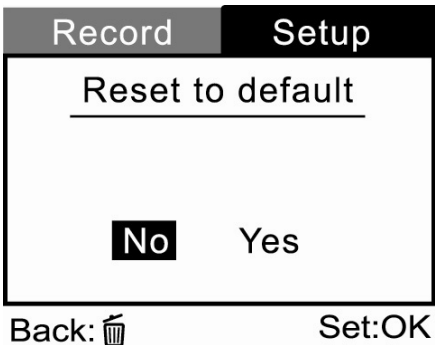

Reset to default

If you wish to restore all camera settings to their original status, select this option and then press the  button. Then select [No] or [Yes] by using the  or  button and then press  button to confirm.



Date type

You can select the date type that is imprinted on your image.

To set the date type, first press the  button. Type you prefer by using the  or  button and then press  button to confirm.

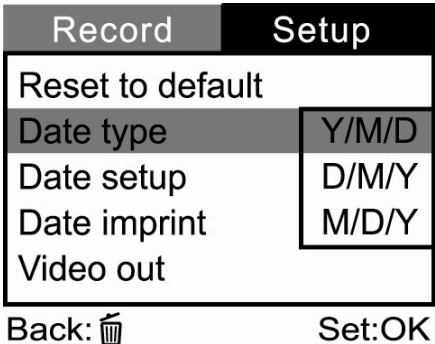





- [Y/M/D] : Year/Month/Day
- [D/M/Y] : Day/Month/Year
- [M/D/Y] : Month/Day/Year

Date setup





After removing the batteries from the camera, the date and time will return to the default setting. If this happens, reset the date and time when using the DV camera. For more information about the date setup, refer to “Setting the date and time”.

Date imprint

If you set imprint function, your image will be displayed with date on it.

To enable this function, first press the  button. Then select [On] or [Off] by using the  or  button and then press  button to confirm.

Video out

You can view your images on a TV. Remember to select correct video output type according to where you locate. Otherwise, there will be white lines on a stored image. To set this option, first press the  button. Then using the  or  button to select your TV receiving system [NTSC] or [PAL] and then press  button to confirm.

[NTSC] : Select this format when located in the U.S.A., Canada, Japan, Korea, Taiwan, Central America or Mexico.

[PAL] : Select this format when located in Australia, Belgium, China, Denmark, Finland, Germany, Great Britain, Holland, Italy, Kuwait, Malaysia, New Zealand, Singapore, Spain Sweden, Switzerland, Thailand or Norway.

Light freq.

Set the frequency of the CMOS sensor.

To set this option, first press the **▶** button. Then using the **▲** or **▼** button to select [50Hz] or [60Hz] and then press **OK** button to confirm.

Language

This option allows you to select the language for the menus and the texts displayed on the LCD monitor.

The provided languages are [English], [Français], [Deutsch],[Español], [Portuguès], [Italiano], 日本語,繁體中文,简体中文

Playback Menu

Use the Playback menu to transfer your recorded video clips/captured images to a memory card or to create an on-camera slide show displaying. You may also use the Playback menu to protect or delete all images from the camera's memory card or an internal memory.

To access the Playback menu, press the **▶▶** button first and then press the **ⓘ** button. Scroll through the menu options by using the **▲** or **▼** button.

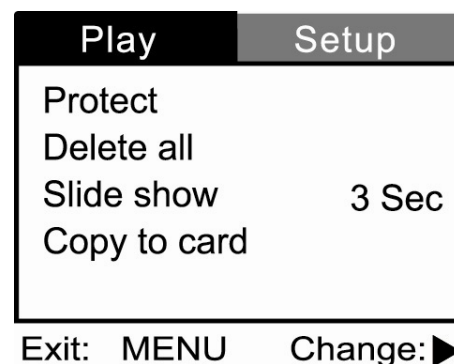

Playback menu items: Protect, Delete all, Slide show and Copy to card.

Protect

This feature prevents images from being deleted accidentally.

Refer to section in this manual titled “Protecting video clips/images” for further detail.

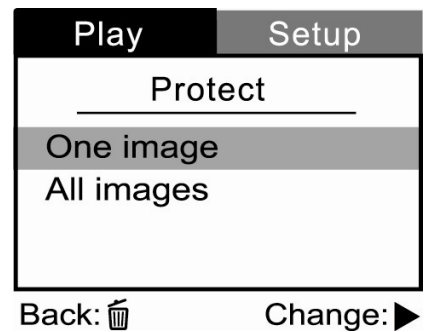

Delete all

Refer to section in this manual titled “Deleting video clips/ images”

Slide show

Your camera can display your images sequentially as a slide show at a selected interval.

[1 sec.], [3 sec.], [5 sec.], [7 sec.], [9 sec.]

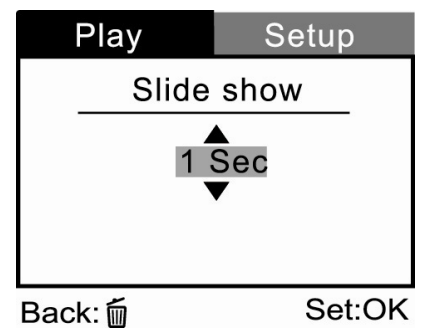

Copy to card

This feature allows you to copy your images from the camera's internal memory to a memory card. Of course, you can only do this if you have a memory card installed and some images in internal memory.

- [NO]: Does not copy the images
- [YES]: Copy all images to the memory card

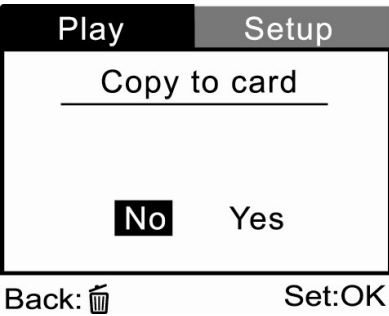

CONNECTING YOUR DIGITAL VIDEO CAMERA TO OTHER DEVICES

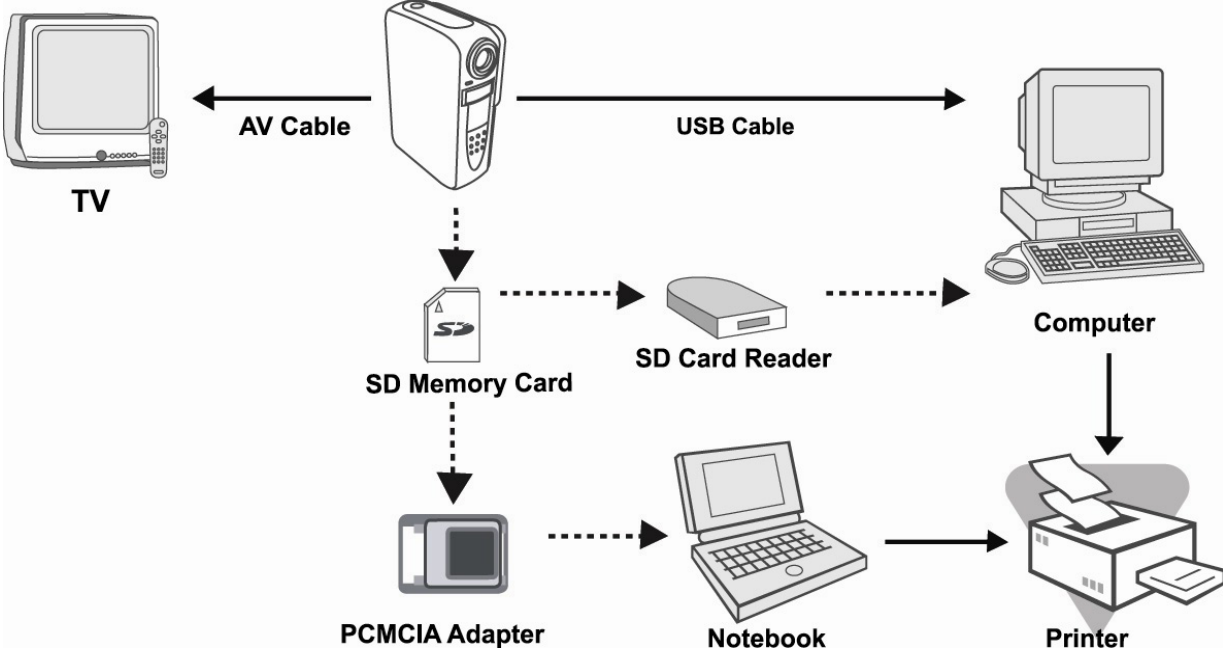

CAMERA SPECIFICATIONS

Item	Description
Image sensor	1/2" CMOS
Effective pixels	2.0 Mega Pixels
Image size	Still Image:1600 x 1200; 800 x 600; Movie image: QVGA 320 x 240
Image quality	Super fine , Fine, Normal
Recording media	64MB internal memory; SD memory card (optional)(up to 512 MB)
Lens	F-no:2.8, 5G All glass, Focus range: 1.4m~infinity
LCD monitor	High resolution(130k dots)1.5" LTPS color LCD
Self-timer	10-second delay
Zoom	Digital: Record mode:2.5X/ Playback mode: 2X/4X
Exposure compensation	Auto; Manual: -1.8 ~ +1.8 EV (0.3 EV)
White Balance	Auto; Manual: Daylight, Shade, Fluorescent 1, Fluorescent 2, Lamp
ISO	ISO 100/ 200/ 400
Light frequency	50/ 60Hz
Compressed format	MPEG 4 SP (video); IMA-ADPCM(Audio)
Standards	EXIF 2.1, DCF1.1, JPEG
Interface	DC IN jack, USB connector, VIDEO OUT jack (NTSC or PAL)
Power	2 x AA Alkaline batteries(optional), 2 x AA Ni-MH batteries(optional) CR-V3(optional), AC power adapter (3.0V/2.5A)(optional)

Software Application	For image:PhotoSuite & PhotoVista For video :WinDVD Creator SVCD Windows Multi-Media Player 9.0 (WMP*.ASF file)
Dimensions	90mm x 65mm x 31mm
Weight	Approx. 123g (without batteries and the SD memory card)

* Design and specifications are subject to change without notice.

APPENDIX

Error Messages

LCD MONITOR DISPLAY	MEANING
MEMORY ERROR	Internal memory access error
CARD ERROR	Optional SD card access error
MEMORY FULL	There is not enough space to store image or video clip in the internal memory.
NO IMAGES	There are no images stored in the internal memory or on an optional SD card
NO CARD	There is no optional SD card inserted in your digital video camera
USB ERROR	USB transmission error
CARD FULL	There is not enough space to store image or video clip on the SD card
LOW LIGHT	Impossible to set auto focus because of poor lighting
“LOW BATTERY” “AUTO” “6”	The battery power is nearly exhausted and is going to shutdown within 6 seconds. The screen will display the count-down (from 6 to 1).