

Honeywell

RTH7500D Programmable Thermostat

OWNER'S GUIDE

The RTH7500D Thermostat provides electronic control of 24 Vac heating and cooling systems or 750 mV heating systems.



For assistance with your Honeywell product, please visit www.honeywell.com/yourhome or call Honeywell Customer Care toll free at 1-800-468-1502.

Read and Save these Instructions

Patents Pending
® U.S. Registered Trademark
© 2004 Honeywell International Inc.
All Rights Reserved



69-1730

Contents

Prepare for Installation	3
Follow Important Instructions	5
Remove Old Thermostat	6
Follow Special Instructions	7
Label Old Thermostat Wires	10
Mount New Wallplate to Wall	11
Connect Wires to New Wallplate	15
Install Batteries	23
Attach New Thermostat to Wallplate	24
Configure Installer Setup	26
Customer Assistance	62
Limited One-Year Warranty	63

Step 1. Prepare for Installation

1. Check that the following items are included:

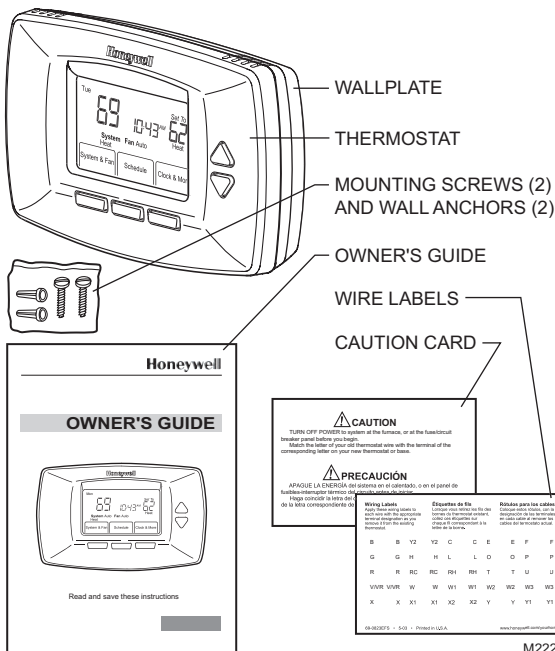

M22278



If any of the items shown above are missing, call Honeywell Customer Care at 1-800-468-1502 before returning the thermostat to the store.

Step 1. Prepare for Installation (Cont)

2. Check that you have everything required for the installation:
 - Two AA alkaline batteries
 - No. 2 Phillips screwdriver and standard pocket screwdriver
 - Drill
 - Drill bit—use 3/16 in. for drywall; use 7/32 in. for plaster
 - Level (optional)
 - Hammer
 - Pencil
 - Electrical tape

Step 2. Follow Important Instructions

1. Do not connect the wires to the new thermostat based on wire color because damage can occur to the heating and/or cooling system.

These Installation Instructions explain later how to use the enclosed wire labels to correctly mark the wires connected to your old thermostat.

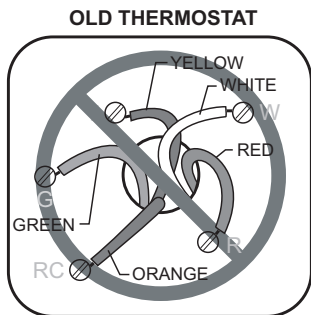

**DO NOT WIRE
NEW THERMOSTAT
BASED ON
WIRE COLOR.**

M22034

Step 3. Remove Old Thermostat

1. Turn off power at the heating and/or cooling system or fuse/circuit breaker panel.
2. Remove the cover from the old thermostat.
3. Remove the old thermostat from the wall or wallplate. Do not remove the wires.

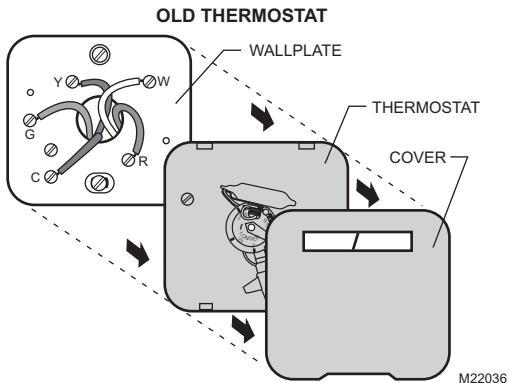

MERCURY NOTICE

If you are replacing a thermostat that contains mercury in a sealed tube, do not place your old thermostat in the trash.

Contact your local waste management authority for instructions regarding recycling and the proper disposal of an old thermostat containing mercury in a sealed tube.

Step 4. Follow Special Instructions

1. If you have **two** C and/or C1 wires connected to your old thermostat, do not connect them to your new thermostat.
2. Disconnect the C and/or C1 wires. Make sure they do not touch each other or any other wires.
3. Wrap the bare end of each C and/or C1 wire with electrical tape.

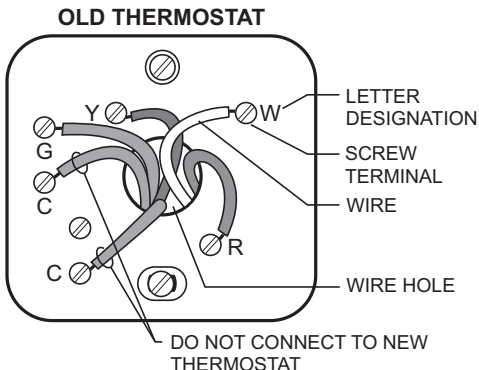

M22201

Step 4. Follow Special Instructions (Cont)

- If you have only **one** C and/or C1 wire connected to your old thermostat, connect this wire to C on the new thermostat.

Visit www.honeywell.com/yourhome or call Honeywell Customer Care at 1-800-468-1502 before returning the thermostat to the store.

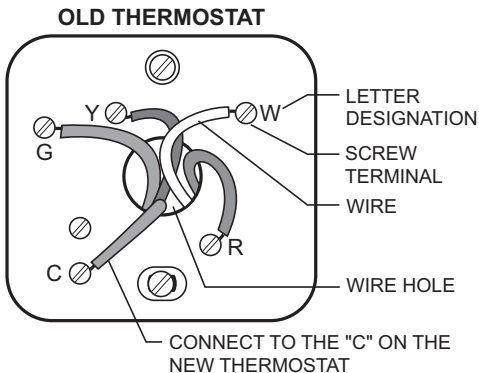

M22223

Step 4. Follow Special Instructions (Cont)

5. If you find any wires not connected to your old thermostat, do not connect them to your new thermostat.
6. Wrap the end of the wires that are not connected with electrical tape.

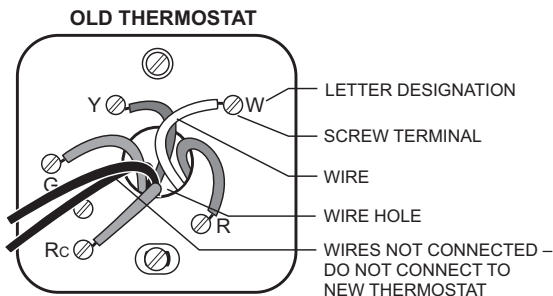

M22040

Step 5. Label Old Thermostat Wires

1. As you disconnect each wire, use the enclosed wire labels to wrap a wire label around each wire that matches the letter designation. Do not allow the wires to fall into the wall opening after the wires are disconnected.
2. Remove any remaining part of the old thermostat from the wall.

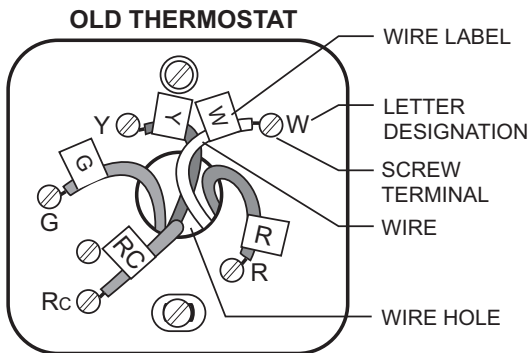

M22039



When connecting the wires to the new thermostat, refer to the wire labels. Do not connect wires to your new thermostat based on the color of the wire.

Step 6. Mount New Wallplate to Wall

1. Separate the wallplate from the thermostat as shown.

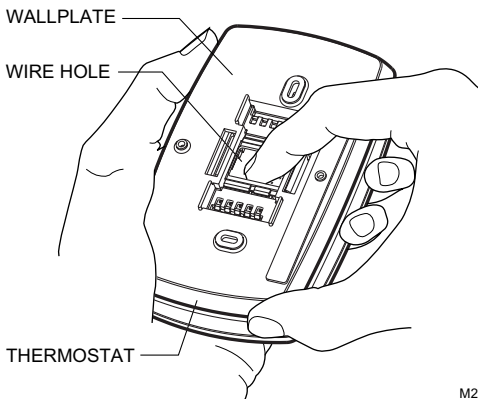

M22267

Step 6. Mount New Wallplate to Wall (Cont)

2. Pass the labeled wires through the wire hole on the wallplate.

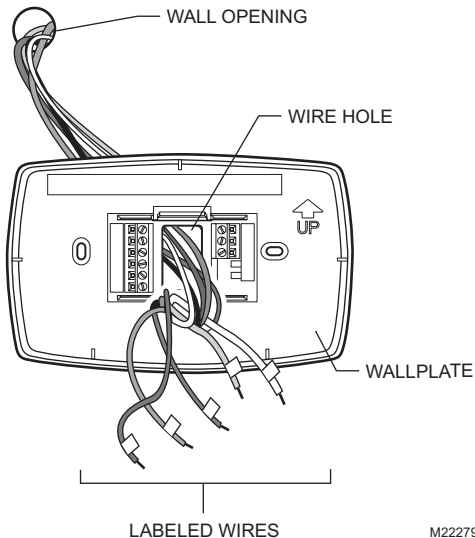

M22279

Step 6. Mount New Wallplate to Wall (Cont)

3. Position the wallplate on the wall with the arrow pointing up. Level the wallplate (for appearance only) and mark the two mounting holes with a pencil.

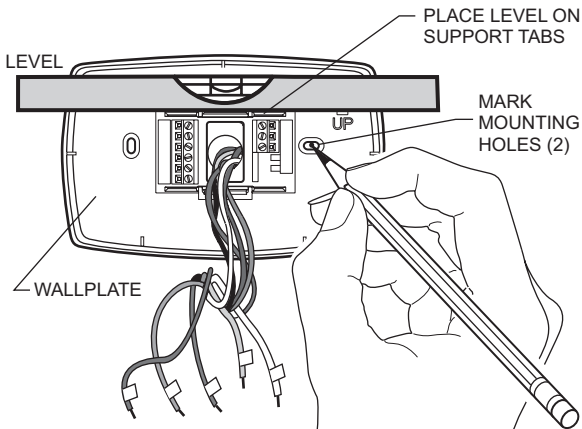

M22292

Step 6. Mount New Wallplate to Wall (Cont)

4. Move the wallplate aside and drill holes at the locations marked on the wall. Drill 3/16 in. holes for drywall or 7/32 in. holes for plaster.
5. Tap the wall anchors into the drilled holes until even with the wall surface.

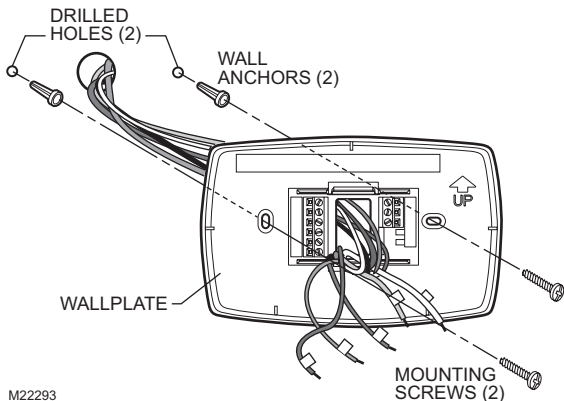

M22293

6. Position the wallplate over the wall anchors.
7. Insert the mounting screws into the wall anchors. Check leveling, if desired, and tighten the mounting screws.

Step 7. Connect Wires to New Wallplate

1. Match the labeled wires to the letter designations on the wallplate.
2. Select the correct letter designations to follow for your system. If you have a standard heating and/or cooling system, use the **CONVENTIONAL** letter designations. If you have a heat pump system, use the **HEAT PUMP** letter designations to wire the new thermostat.

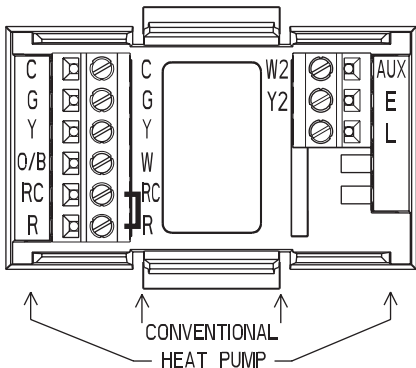

M22294



See table on page 29 to help you determine if you have a **CONVENTIONAL** or **HEAT PUMP** system.

Step 7. Connect Wires to New Wallplate (Cont)

3. If wires are to be connected to both Rc and R, loosen the Rc and R screw terminals and remove the metal jumper wire.
4. If only one of the terminals, Rc or R, is to be connected, leave the metal jumper wire in place.

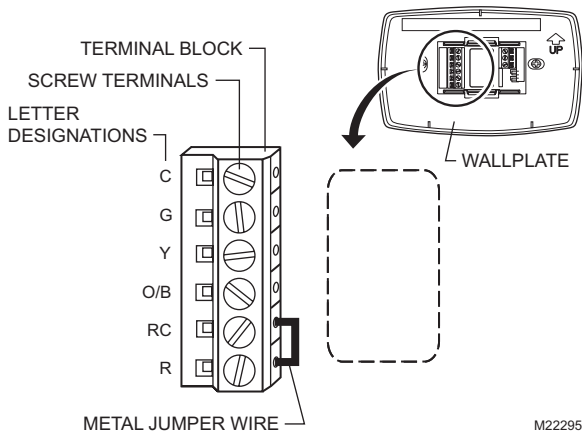

M22295

Step 7. Connect Wires to New Wallplate (Cont)

- Loosen the screw terminals. Insert the labeled wires into the holes on the side of the terminal block that match the letter designations. Tighten the screw terminals.
- If any of the labeled wires do not match the letter designations, see next page for wire connections.

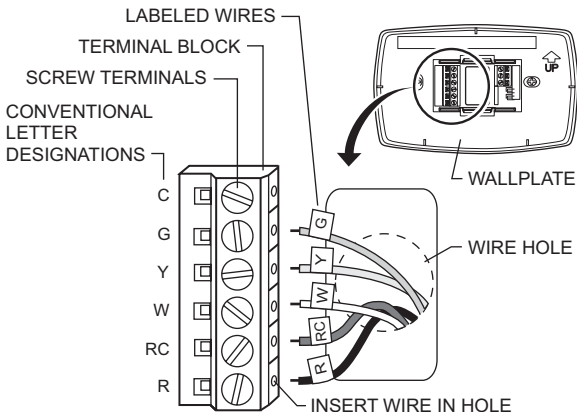

M22325

Step 7. Connect Wires to New Wallplate (Cont)

7. Compare letter designations on your old and new thermostats. Use the information below if you are wiring a **CONVENTIONAL** System. Use the information on page 20 if you are wiring a Heat Pump system.

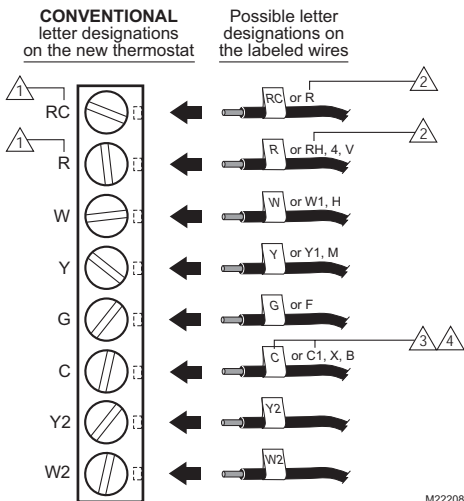

M22208



Do not connect more than one wire to each terminal. Be sure to read the notes referenced in the numbered triangles above. These numbered notes appear on the next page.

Step 7. Connect Wires to New Wallplate (Cont)

NOTES FOR CONVENTIONAL HEATING AND COOLING SYSTEMS

- 1 If wires will be connected to both Rc and R on the new thermostat, remove metal jumper wire between Rc and R. Leave metal jumper wire in place if only one of the terminals, Rc or R, will be connected on the new thermostat.
- 2 If wires were connected to both R and RH terminals on the old thermostat, remove metal jumper wire between Rc and R on the new thermostat. Connect the old R to the new Rc and the old RH to the new R.
- 3 If **two** C and/or C1 wires were connected to the old thermostat, do not connect them to the new thermostat. Wrap the bare end of each wire separately with electrical tape and do not use.
- 4 If **one** C and/or C1 wire was connected to the old thermostat, the wire should be connected to the "C" letter designation on the new thermostat.

M22246

Step 7. Connect Wires to New Wallplate (Cont)

8. Compare letter designations on your old and new thermostats. Use the information below if you are wiring a **HEAT PUMP** system.

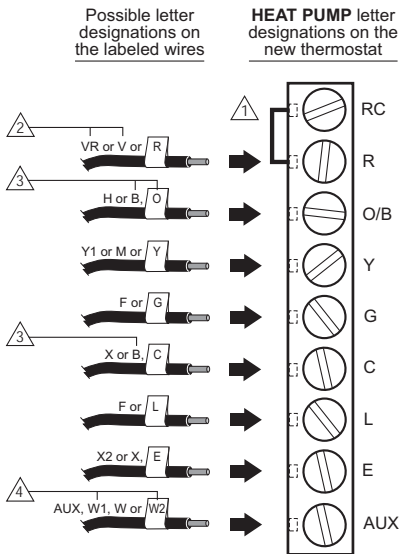





M22210



Be sure to read the note referenced in the numbered triangles above. These numbered notes appear on the next page.

Step 7. Connect Wires to New Wallplate (Cont)

NOTES FOR HEAT PUMP SYSTEMS

-  Leave metal jumper wire between RC and R in place.
-  If the old thermostat had separate wires on both the V and VR, some system modification is required. Call your local heating and cooling contractor for assistance.
-  If the old thermostat had wires on both O and B, be sure to attach the B wire to the C letter designation on the new thermostat. If another wire is already matched to the C, contact Honeywell.
-  If the old thermostat had wires on W1, Y1 and W2, some system modification is required. Call your local heating and cooling contractor for assistance.

M22245

Step 7. Connect Wires to New Wallplate (Cont)

9. Push excess wire back into the wall opening. Keep wires in the shaded area.

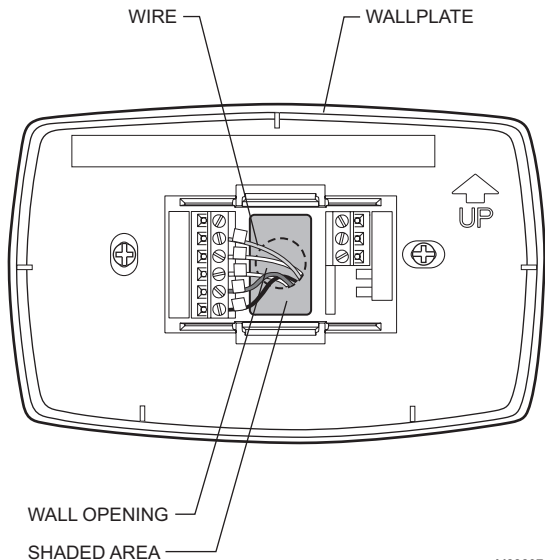

M22297

Step 8. Install Batteries

1. Install two fresh AA alkaline batteries on the back of the thermostat as marked on the thermostat.

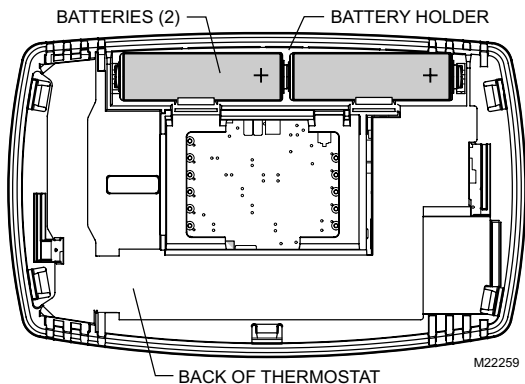

2. Remove tab labeled "Remove during installation" in the lower right corner of the thermostat back.

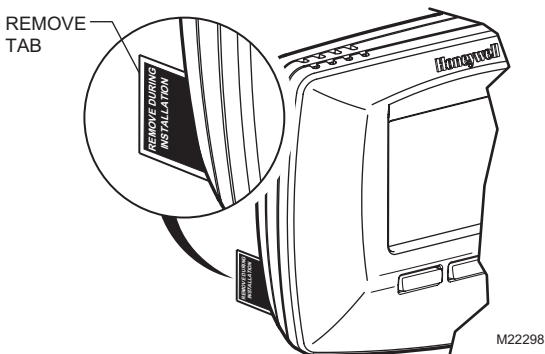

Step 9. Attach New Thermostat to Wallplate

1. Align the screw blocks with the pins on the back of the thermostat.

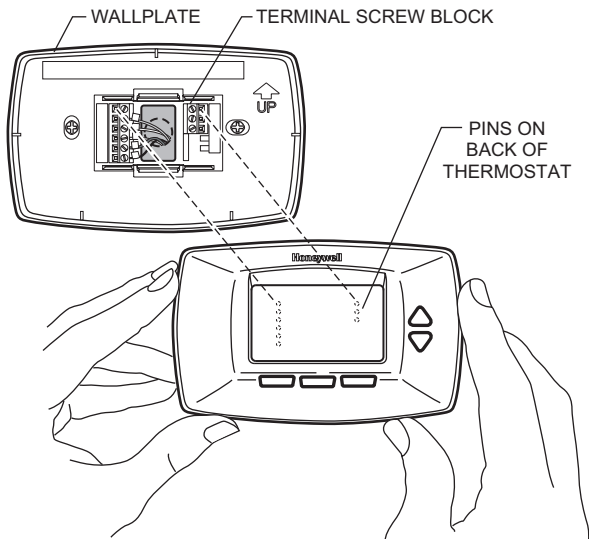

M22299

2. Push the thermostat straight onto the wallplate until it snaps into place.
3. Turn on the power at the heating and/or cooling system or fuse/circuit breaker panel.



If the wires interfere with mounting the thermostat to the wallplate, push the excess wire back into the wall opening.

Step 10. Set the Calendar

This thermostat is designed to automatically keep current time and day in memory for up to ten years, under normal use, once the calendar is set. When the thermostat is first powered, the display is ready to set the calendar.

1. Use Up or Down arrow button to set the Month.

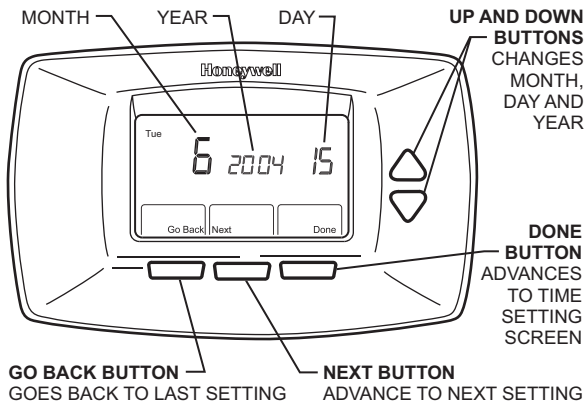

M22302

2. Press the Next button to advance to the Date.
3. Use the Up or Down arrow button to set the Date.
4. Press the Next button to advance to the Year.
5. Use the Up or Down arrow button to set the Year.
6. Press the Done button to advance to the Time.
7. Use the Up or Down arrow button to set the Time.

Step 10. Set the Calendar (Cont)

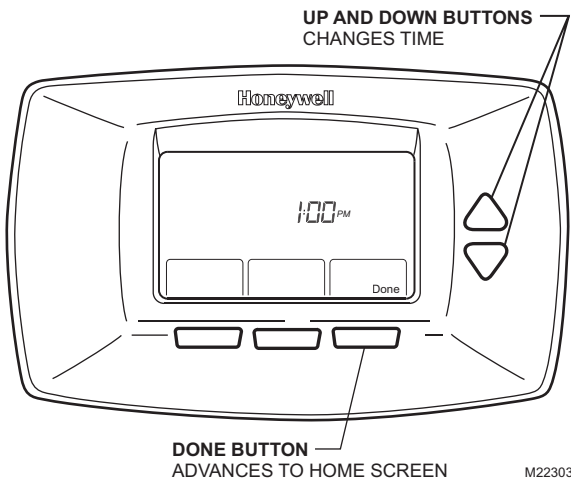

8. Press the Done button.



The calendar can be set anytime. See Step 11, Configure Installer Setup, for instructions.

Step 11. Configure Installer Setup

1. Use the Installer Setup Menu to match your new thermostat to your heating and/or cooling system. Follow the steps in this section to set up your thermostat.
2. Press and release the System button.

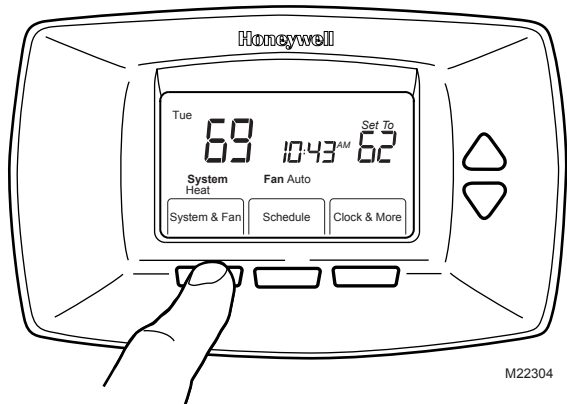

Step 11. Configure Installer Setup (Cont)

3. Press and hold the center button for approximately five seconds, until the screen changes.

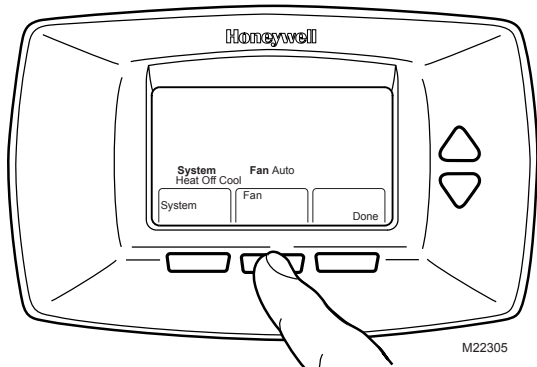

4. Release the center button when the display on your thermostat matches the display below.

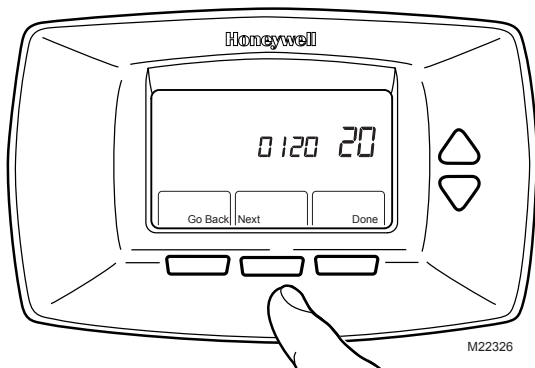

11. Configure Installer Setup (Cont)

- Press the Up or Down arrows to select your setting for Installer Setup Number 0120 below.
- After you select your setting, press the Next button to go to the next Installer Setup Number.
- Follow steps 5 and 6 to set Installer Setup Numbers 0130, 0140 and 0150 to complete setting the calendar.

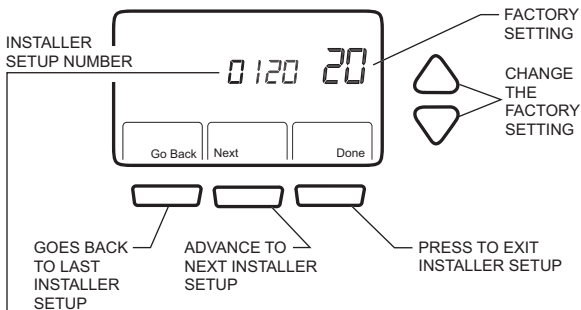

Installer Setup Number	Installer Setup Name	(Select Your Setting) Settings
0120	Date (Year Upper)	Select first two digits of current calendar year (20 for year 2005 , etc).
0130	Date (Year Lower)	Select last two digits of current calendar year (05 for year 2005 , etc).
0140	Date (Month)	Select number that represents current calendar month.
0150	Date (Day)	Select number that represents current calendar date.

Step 11. Configure Installer Setup (Cont)

8. Press the Up or Down arrows to select your setting for Installer Setup Number 0170.
9. After you select your setting, press the Next button to go to the next Installer Setup Number.



Installer Setup Number	Installer Setup Name	(Select Your Setting) Settings
0170	System Type Selection	<ol style="list-style-type: none"> 1 - Heating and Cooling (Conventional) -- Gas, oil or electric heating with central air conditioning. 2 - Single-stage Heat Pump with no back-up or auxiliary heat -- the compressor runs in both heating and cooling. 3 - Heat Only with no fan (Conventional) -- Gas, oil or electric heating without central air conditioning. No wire on the G terminal on new thermostat. 4 - Heat Only with fan (Conventional) -- Gas, oil or electric heating without central air conditioning. Typically wires are R, W and G on new thermostat. 5 - Hot Water Heat Only (Conventional) -- Gas or Oil hot water heat with three wires connected to new thermostat or for normally closed hot water valves with wires connected to R and Y on new thermostat. 6 - Cool Only (Conventional) -- Central air conditioning only. 7 - Multistage Heat Pumps -- heat pump with auxiliary or back-up heat. 8 - Multistage Conventional Heating and Cooling -- 2 stages of Heat (wires on W and W2) and 2 stages of Cool (wires on Y and Y2). 9 - Multistage Conventional Heating and Cooling -- 2 stages of heat (wires on W and W2) and 1 stage of Cool (wire on Y). 10 - Multistage Conventional Heating and Cooling -- 1 stage of heat (wire on W) and 2 stages of Cool (wires on Y and Y2).

M22308

Step 11. Configure Installer Setup (Cont)

10. If you do not have a number 0180 on the left side of your display, go to the next page.
11. If you have a number 0180 on the left side of your display, press the Up or Down arrow to select your setting for Installer Setup Number 0180.
12. After you select your setting, press the Next button to go to the next Installer Setup Number.

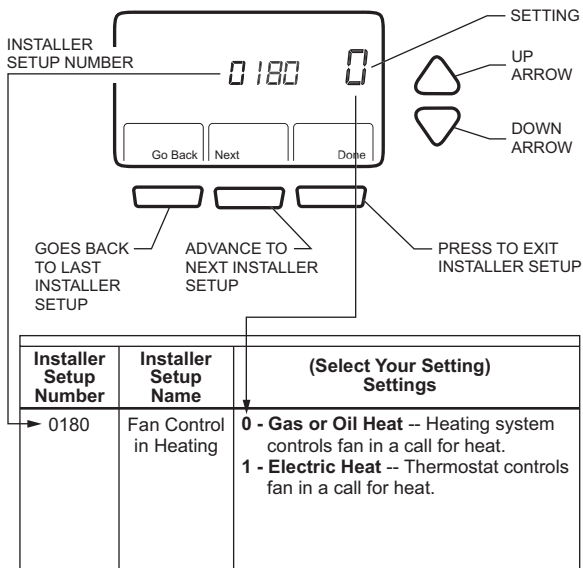

M22309

Step 11. Configure Installer Setup (Cont)

13. If you do not have a number 0190 on the left side of your display, go to the next page.
14. If you have a number 0190 on the left side of your display, press the Up or Down arrow to select your setting for Installer Setup Number 0190.
15. After you select your setting, press the Next button to go to the next Installer Setup Number.

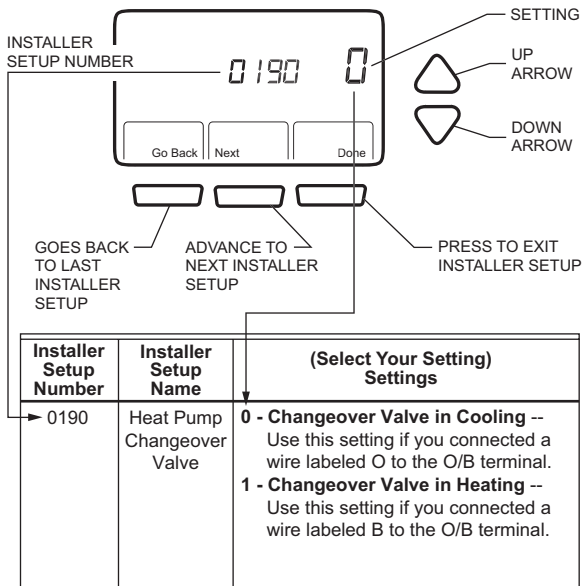

M22310

Step 11. Configure Installer Setup (Cont)

16. If you do not have a number 0240 on the left side of your display, go to the next page.
17. If you have a number 0240 on the left side of your display, press the Up or Down arrow to select your setting for Installer Setup Number 0240.
18. After you select your setting, press the Next button to go to the next Installer Setup Number.

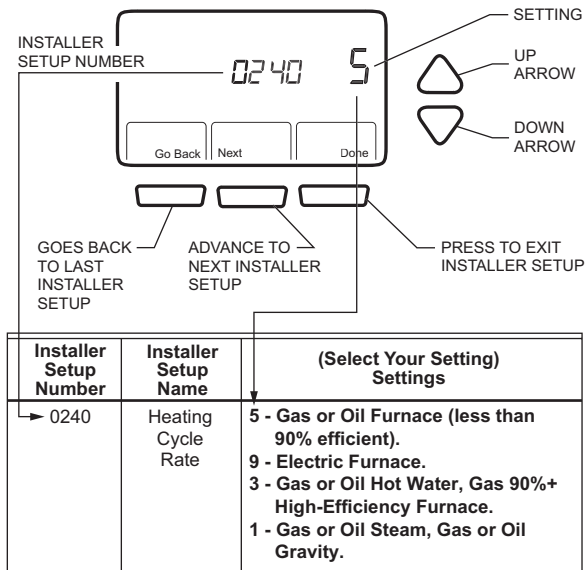

M22329

Step 11. Configure Installer Setup (Cont)

19. Press the Up or Down arrow to select your setting for Installer Setup Number 0320.
20. After you select your setting, press the Next button to go to the next Installer Setup Number.

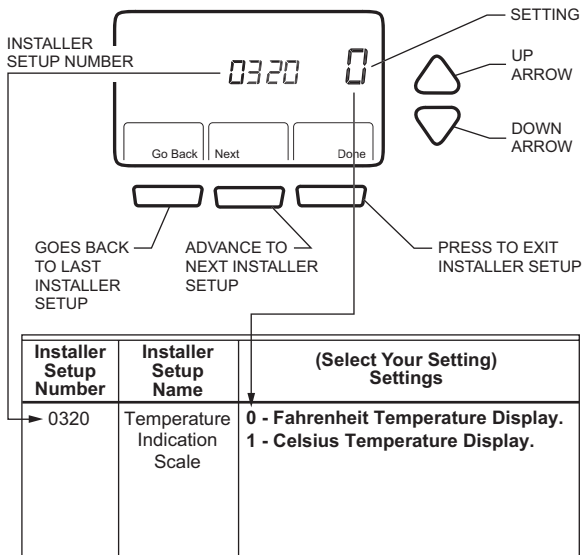

M22311

Step 11. Configure Installer Setup (Cont)

21. Press the Up or Down arrow to select your setting for Installer Setup Number 0330.
22. After you select your setting, press the Next button to go to the next Installer Setup Number.

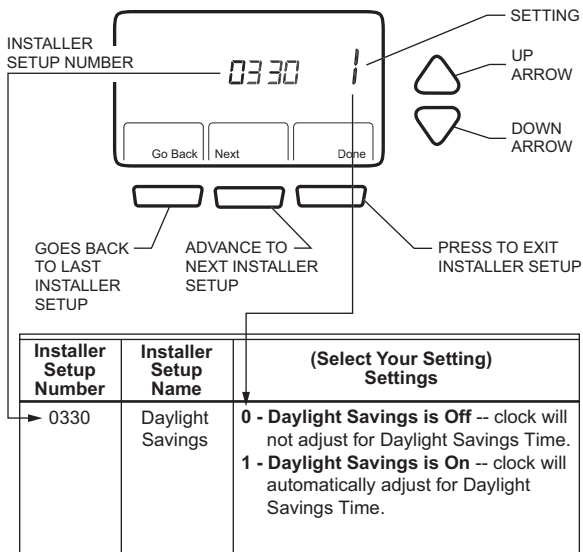

M22312

Step 11. Configure Installer Setup (Cont)

23. Press the Up or Down arrow to select your setting for Installer Setup Number 0500.
24. After you select your setting, press the Next button to go to the next Installer Setup Number.

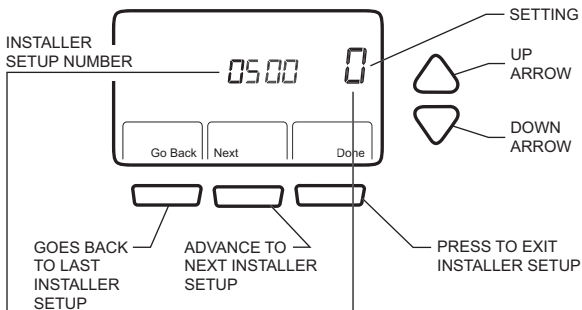

Installer Setup Number	Installer Setup Name	(Select Your Setting) Settings
0500	Furnace Filter Change Reminder	<p>0 - Furnace Filter change reminder is Off</p> <p>1 - Approximately 1 month -- based on 10 days of fan run time.</p> <p>2 - Approximately 3 months -- based on 30 days of fan run time.</p> <p>3 - Approximately 6 months -- based on 60 days of fan run time.</p> <p>4 - Approximately 9 months -- based on 90 days of fan run time.</p> <p>5 - Approximately 1 year -- based on 120 days of fan run time.</p> <p>6 - Approximately 3 years -- based on 365 days of fan run time.</p>

M22313

Step 11. Configure Installer Setup (Cont)

25. Press the Up or Down arrow to select your setting for Installer Setup Number 0530.
26. After you select your setting, press the Next button to go to the next Installer Setup Number.

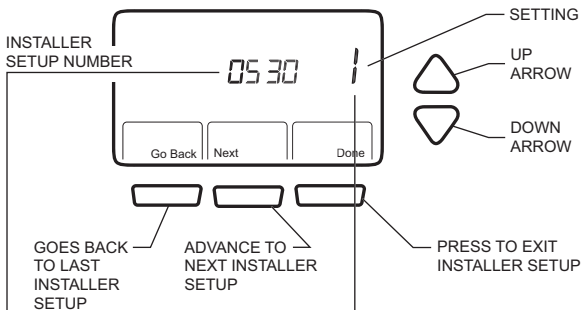

Installer Setup Number	Installer Setup Name	(Select Your Setting) Settings
0530	Adaptive Intelligent Recovery™	<p>0 - Conventional recovery -- system starts recovery at programmed time.</p> <p>1 - Adaptive Intelligent Recovery™ -- system starts early so the setting is reached by the start of programmed period.</p>

M22314

Step 11. Configure Installer Setup (Cont)

27. Press the Up or Down arrow to select your setting for Installer Setup Number 0640.
28. After you select your setting, press the Done key to exit the Installer Setup and save your settings.
29. Congratulations! The installation of the thermostat is complete.

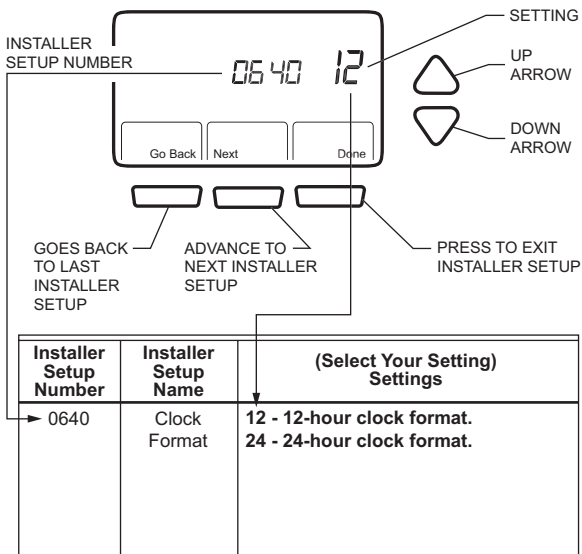

M22315

Get to Know Your Thermostat Buttons

Thermostat

DOWN BUTTON

LOWERS TEMPERATURE SETTING OR
MAKES SELECTIONS IN OTHER SCREENS

UP ARROW BUTTON

RAISES TEMPERATURE SETTING OR
MAKES SELECTIONS IN OTHER SCREENS

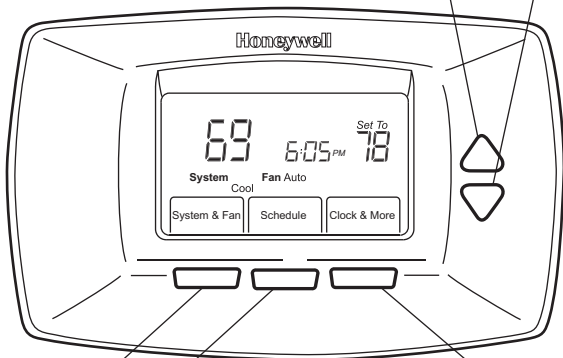

SCHEDULE BUTTON

SELECTS PROGRAMMING
MODE

SYSTEM & FAN BUTTON

SELECTS FAN AUTO OR ON
SELECTS HEAT, OFF, COOL
AND EM HEAT

CLOCK &

MORE BUTTON

SELECTS TIME AND
FURNACE FILTER
INFORMATION

M22316

Get to Know Your Thermostat Display

Display

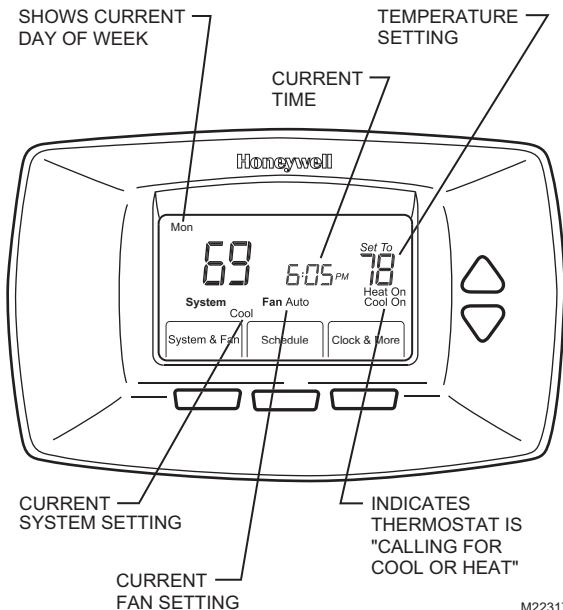

M22317

Set System Setting

Set System Setting

Press the System button to select Heat, Off or Cool:

Heat—Thermostat controls the heating system.

Off—Heating and cooling systems are both off.

Cool—Thermostat controls the cooling system.

Em. Heat (Heat Pump Systems with Auxiliary Heat)—Thermostat controls emergency heat and auxiliary heat, if needed. Heat Pump compressor is not operational.



CAUTION

Equipment Damage Hazard.

Air conditioning compressor damage possible.

Do not operate cooling system when outdoor temperature is below 50 °F (10 °C).

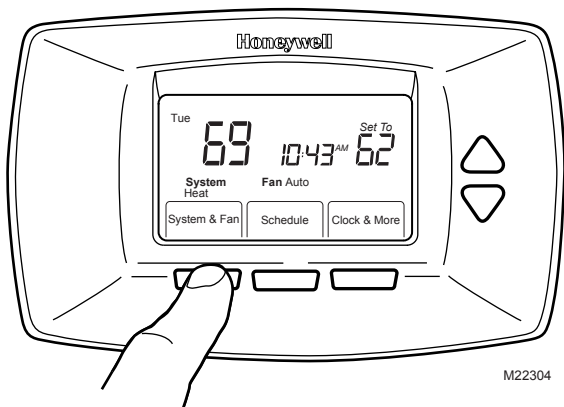

Set System Setting (Cont)

Set Fan Setting

1. Press System & Fan button.
2. Press the Fan button to select Auto or On:

Auto—Normal setting for most homes. The fan runs only when the heating or cooling system is on.

On—The fan runs continuously. Use this setting for improved air circulation or for more efficient air cleaning.

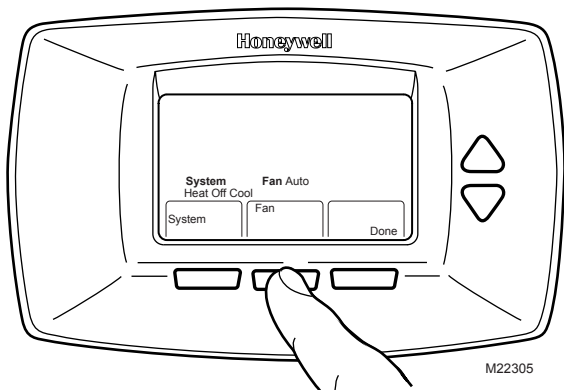

Program Your Heating and Cooling Schedule

Your thermostat can control up to four different schedule periods for each day:

Wake—Period when you awaken and want your home at a comfortable temperature.

Leave—Period when you are away from home and want an energy-saving temperature.

Return—Period when you return home and want your home back to a comfortable temperature.

Sleep—Period when you are asleep and want an energy-saving temperature.

Edit Schedule

1. Press the Schedule button.

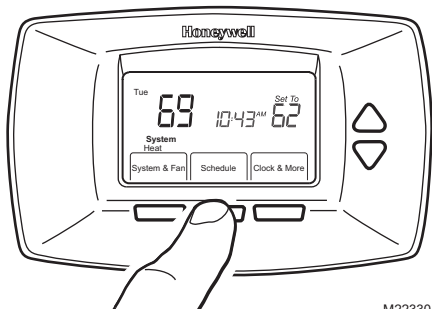

Press the View button to look at the schedule without editing the schedule.

Tip

Program Your Heating and Cooling Schedule (Cont)

2. Press the Edit button.

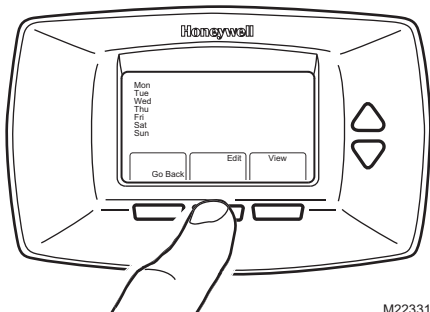

M22331

Program Your Heating and Cooling Schedule (Cont)

- Monday through Friday flashes. Press the Select Day button to select Monday through Friday. The days selected are scheduled with the same times and temperatures. Checkmarks appear next to the days selected.

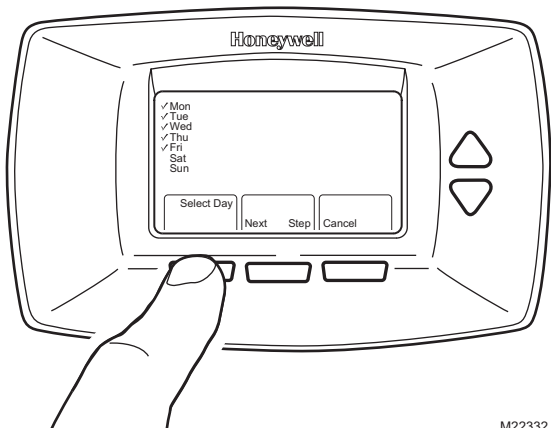

M22332



You can select each day separately. Use the Up and Down buttons to move up and down the list of days. Use the Select Day or DeSelect Day button to select the days you want to schedule.

Program Your Heating and Cooling Schedule (Cont)

4. Press the Next Step button. Once pressed, Wake flashes to show it is selected.

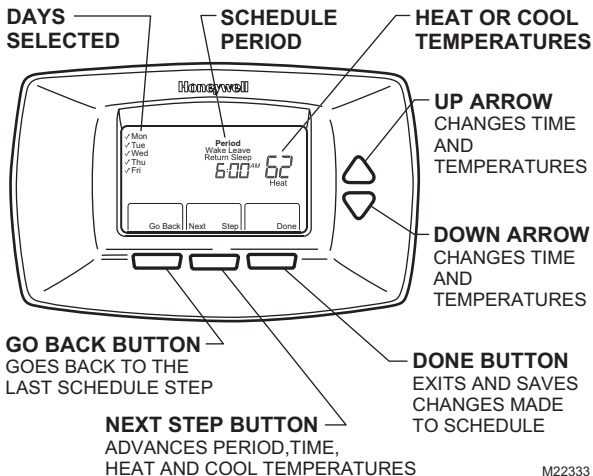

M22333

5. Press the Next Step button to select the Wake time.
6. Use the Up and Down arrow buttons to change the time.
7. Press the Next Step button to select the Heating temperature.
8. Use the Up and Down arrow buttons to change the temperature.
9. Press the Next Step button to select the Cooling temperature.
10. Use the Up and Down arrow buttons to change the temperature.
11. Repeat steps 5 through 10 for the Leave, Return and Sleep schedules.

Program Your Heating and Cooling Schedule (Cont)

- When complete, press the Done button. "Saved" appears on the display to indicate changes are being saved to the day(s) selected.

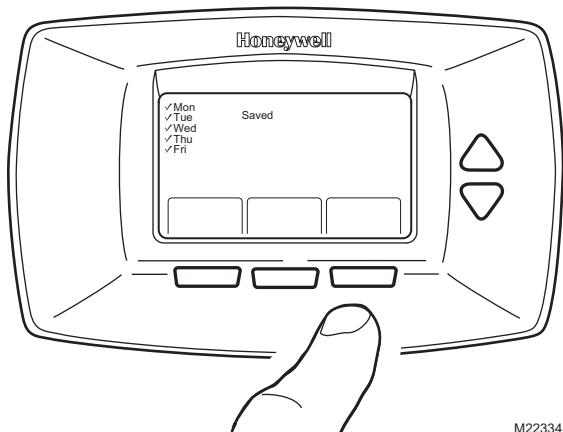

M22334

- To set a program schedule for Saturday and Sunday, repeat steps 1 through 12.



To select Saturday and /or Sunday to schedule, use the Down arrow button until Sat or Sun is flashing. When the desired day(s) is flashing, press the Select Day button.

Set Time

Set Time

1. Press Clock & More button.
2. Use the Up and Down arrow buttons to set the current time.

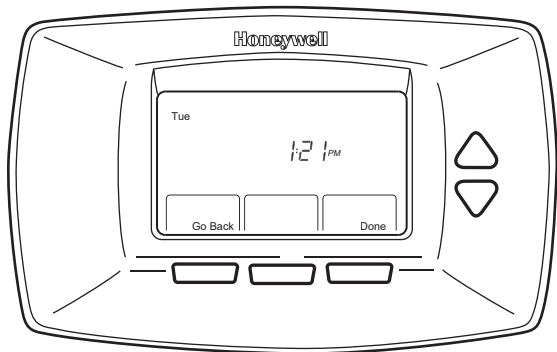

M22335

3. Press the Done button.



The current day of the week should already be set correctly. If not, see Step 11, Configure Installer Setup.

Set Temperature Overrides

Hold Temperature Until (Temporary Hold)

Hold temperature temporarily until the next scheduled period time.

1. Press the Up or Down arrow buttons next to the temperature you want to adjust. "Temporary" appears on the display above the set temperature.

MOVES TEMPERATURE
SETTING UP OR DOWN

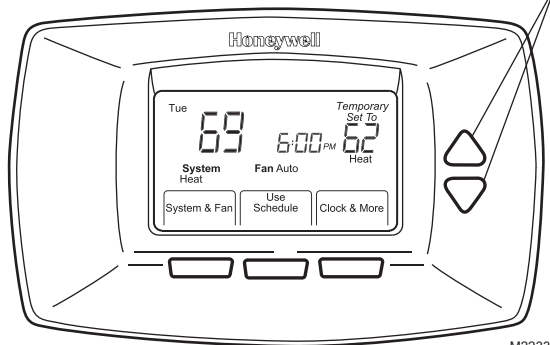

M22336

2. Press the Use Schedule button to cancel "Temporary" temperature and resume schedule.

Set Temperature Overrides (Cont)

Permanent Hold

Permanent Hold changes the temperature setting until Permanent Hold is cancelled.

1. Use the Up or Down arrow buttons to set the temperature you want during the hold.
2. Press the Hold button. "Permanent Hold" shows on the display.

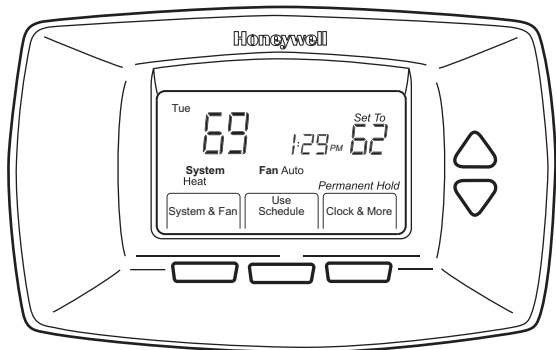

M22337

3. Press the Use Schedule button to cancel "Permanent Hold" and resume the schedule.



The display shows Permanent Hold until it is cancelled.

Use Your Filter Timer

The Filter Timer notifies you when to change your furnace filter.

Reset Filter Timer

1. “Change Filter” appears on the display when the filter timer expires.
2. Press the Reset button to restart the filter timer.

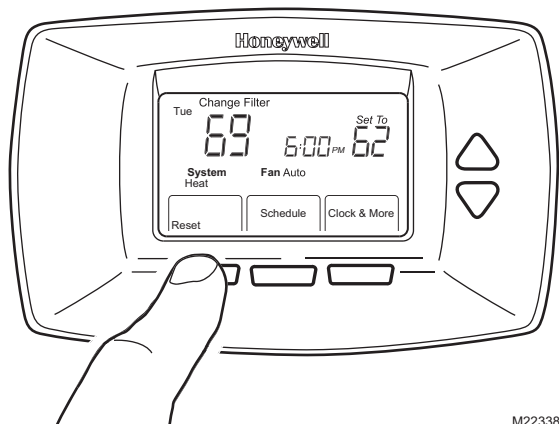

M22338



See Step 11 to turn the Filter Timer Change Reminder feature on or off.

Use Your Filter Timer (Cont)

View or Reset The Remaining Change Filter Time

1. Press the Clock & More button.
2. Press the Next button.

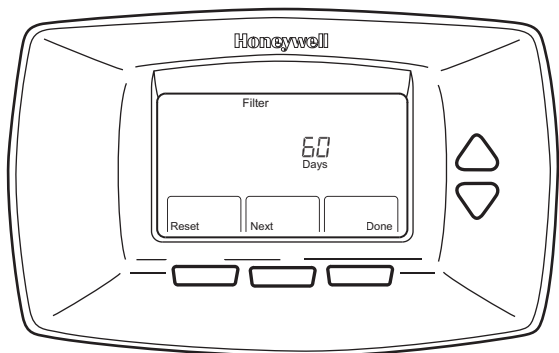

M22339

3. Press the Reset button to Restart the filter timer, if desired.
4. Press the Done button.



See Step 11 to turn the Filter Timer Change Reminder feature on or off.

Understand Temperature Recovery Feature

Your thermostat comes with a feature called Adaptive Intelligent Recovery™, which eliminates all guesswork when setting your schedule. How long does it take the furnace to warm your house in the morning before you get out of bed or how long does it take the air conditioner to cool your house in the afternoon before you return from work? No problem. The thermostat determines that for you.

Simply set your program schedule to the time you want the house to be at your comfort temperature. The thermostat then turns on the heating or cooling at just the right time to have your home reach your scheduled temperature at your scheduled time.

For example—you get out of bed at 6:00 AM and want the temperature to be 70°F. Set the Wake period for 6:00 AM and 70°F. The thermostat then turns on the heat before 6:00 AM to raise the temperature to 70°F by 6:00 AM.

The thermostat alerts that the heating or cooling system is coming on before a scheduled time when “Recovery” shows on the screen.

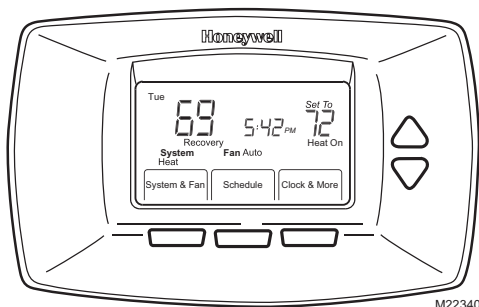

It takes about a week for the thermostat to adjust to local weather, your schedule, the construction of your home and your heating and/or cooling system. Each day it adjusts the next day's recovery start time accordingly.

Replace Batteries

1. When the LO Battery indicator is flashing, replace the batteries promptly with two fresh AA alkaline batteries.

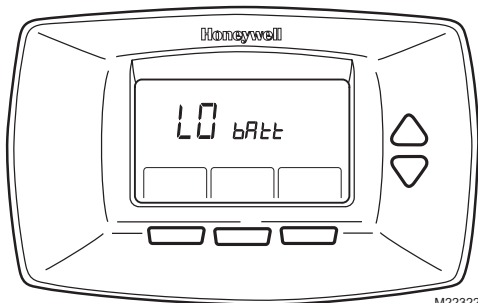

M22322

2. Remove thermostat from the wallplate by pulling straight out.

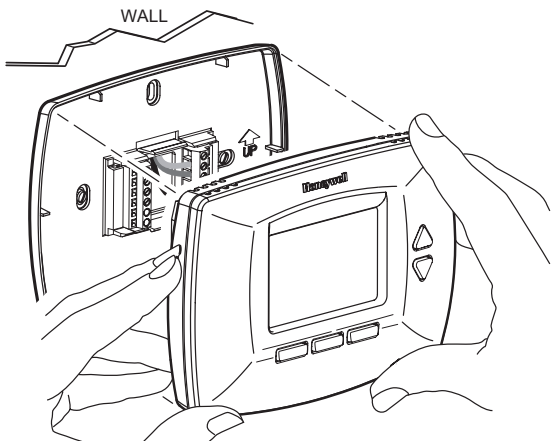

Replace Batteries (Cont)

3. Remove the old batteries and insert two fresh AA alkaline batteries, as marked on the thermostat.

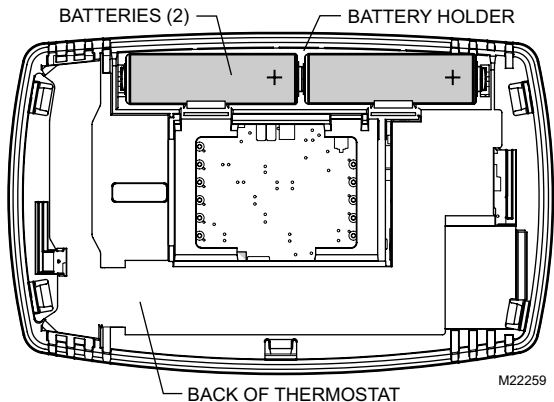

Replace Batteries (Cont)

4. Align the screw blocks with the pins on the back of the thermostat.

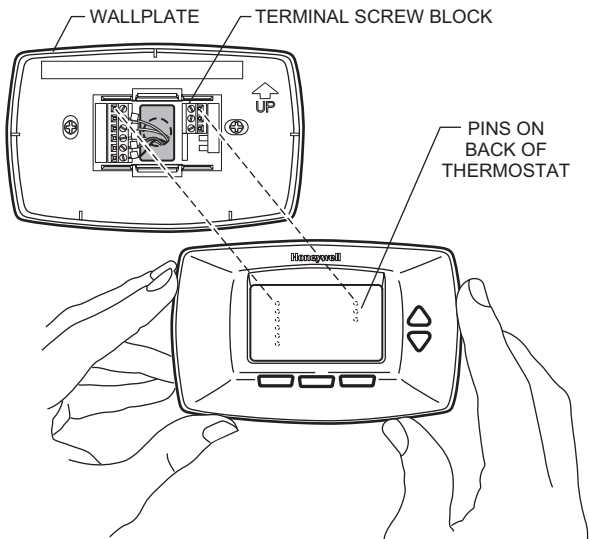

M22299

5. Push the thermostat straight onto the wallplate until it snaps into place.

Review Battery Tips

1. Replace the batteries as soon as LO Batt flashes in the display. The LO Battery indicator flashes in the display one month before the batteries run down completely.
2. Always use fresh AA alkaline batteries. Non-alkaline batteries do not last as long and can leak, causing thermostat damage.
3. Although the thermostat has a Low Battery indicator, replace the batteries once a year to prevent the thermostat and heating/cooling system from shutting down due to lack of battery power.
4. As a precaution, replace the batteries when leaving your home for more than a month to prevent your heating/cooling system from shutting down if the batteries run down completely.

Built-in Compressor Protection

The RTH7500D Thermostat has built-in compressor protection (minimum-off timer) that prevents the compressor from restarting too early after a shutdown.

The minimum-off timer is activated after the compressor turns off.

If there is a call during the minimum-off timer, the thermostat shows “Wait” in the display.

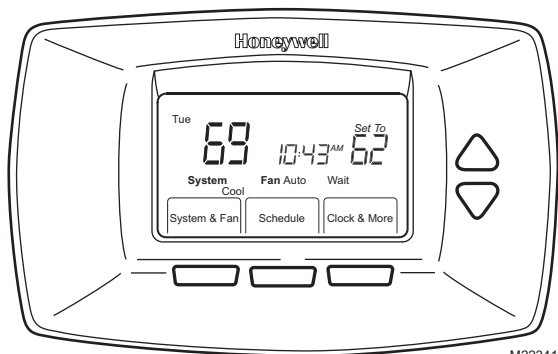

When the minimum-off timer expires, “Cool On” or “Heat On”^a appears solidly in the display and the compressor and fan turn on.

^aHeat Pumps only.

Troubleshooting Tips

If . . .	Then . . .
Display is blank.	Check that fresh AA alkaline batteries are installed as marked on the thermostat.
Temperature settings do not change.	Check that the temperature settings are: <ul style="list-style-type: none">• Heating 40°F to 90°F (4.5°C to 32°C).• Cooling 50°F to 99°F (10°C to 37°C).
Heating system does not turn on.	<ul style="list-style-type: none">• Set the system to Heat by pressing the System button.• Check the heat temperature setting to be sure it is set above the room temperature and “Heat On” shows solidly in the display.• Check the circuit breaker to be sure it is not tripped.• Check power switch at heating and/or cooling system to be sure it is on.• Check the furnace door to be sure it is closed securely.• Wait five minutes for the heating system to respond.• If all of this was checked, contact your local heating and cooling contractor.
Cooling system does not turn on.	<ul style="list-style-type: none">• Set the system to Cool by pressing the System button.• Check the cool temperature setting to be sure it is set below the room temperature and “Cool On” shows solidly in the display.• Check the circuit breaker to be sure it is not tripped.• Check the power switch at the heating and/or cooling system to be sure it is on.• Check the furnace door to be sure it is closed securely.• Wait five minutes for the cooling system to respond.• If all of this was checked, contact your local heating and cooling contractor.

Troubleshooting Tips (Cont)

If . . .	Then . . .
Cannot set System setting to Cool.	Check Installer Setup Number 0170, Heating and/or Cooling System Type; make sure the setting matches the installed heating and/or cooling system.
"Heat On" is not shown in the display.	Set the System setting to Heat and set the temperature setting above the room temperature. If "Heat On" is shown solidly in the display, but the heating system does not turn on, see "Heating system does not turn on" in the Troubleshooting Tips.
"Cool On" is not shown in the display.	Set the System setting to Cool and set the temperature setting below the room temperature. If "Cool On" is shown solidly in the display, but the cooling system does not turn on, see "Cooling system does not turn on" in the Troubleshooting Tips.
"Wait" shows in the display.	Compressor minimum-off timer is active. Wait up to five minutes for the cooling or heating system to turn on.
Fan does not turn on in a call for heat (electric furnaces only).	Check Installer Setup Number 0180, Fan Control in Heating, and make sure it is set to Electric Heat.
Heat pump puts out cool air in the heat mode and warm air in the cool mode (heat pumps only).	Check Installer Setup Number 0190, Heat Pump Changeover Valve, and make sure the setting matches the changeover required by the installed heat pump.

Troubleshooting Tips (Cont)

If . . .	Then . . .
Both the heating and cooling systems are running at the same time.	Check Installer Setup Number 0170, Heating and/or Cooling System Type, and make sure the setting matches the installed heating and/or cooling system.
	Check and make sure the bare portions of the wires are not touching.
Heating system is running in cool mode.	Check Installer Setup Number 0170, Heating and/or Cooling System Type, and make sure the setting matches the installed heating and/or cooling system.
Heating system does not turn off and the heat temperature setting is set below the room temperature ("Heat On" is not shown in display).	Check Installer Setup Number 0170, Heating and/or Cooling System Type, and make sure the setting matches the installed heating and/or cooling system.
Red LED is on in the upper left corner and the Heat Pump is not working.	A system monitor is wired to the thermostat L terminal. See Heating or Cooling system does not turn on in the Troubleshooting Tips.

Customer Assistance

For assistance with your Honeywell product, please visit www.honeywell.com/yourhome or call Honeywell Customer Care toll free at 1-800-468-1502.

Limited One-Year Warranty

Honeywell warrants this product, excluding battery, to be free from defects in the workmanship or materials, under normal use and service, for a period of one (1) year from the date of purchase by the consumer. If, at any time during the warranty period, the product is defective or malfunctions, Honeywell shall repair or replace it (at Honeywell's option) within a reasonable period of time.

If the product is defective,

- (i) return it, with a bill of sale or other dated proof of purchase, to the retailer from which you purchased it, or
- (ii) package it carefully, along with proof of purchase (including date of purchase) and a short description of the malfunction, and mail it, postage prepaid, to the following address:

Honeywell Return Goods
Dock 4 MN10-3860
1885 Douglas Dr N
Golden Valley, MN 55422

This warranty does not cover removal or reinstallation costs. This warranty shall not apply if it is shown by Honeywell that the defect or malfunction was caused by damage which occurred while the product was in the possession of a consumer.

Honeywell's sole responsibility shall be to repair or replace the product within the terms stated above. HONEYWELL SHALL NOT BE LIABLE FOR ANY LOSS OR DAMAGE OF ANY KIND, INCLUDING ANY INCIDENTAL OR CONSEQUENTIAL DAMAGES RESULTING, DIRECTLY OR INDIRECTLY, FROM ANY BREACH OF ANY WARRANTY, EXPRESS OR IMPLIED, OR ANY OTHER FAILURE OF THIS PRODUCT. Some states do not allow the exclusion or limitation of incidental or consequential damages, so this limitation may not apply to you.

Limited One-Year Warranty (Cont)

THIS WARRANTY IS THE ONLY EXPRESS WARRANTY HONEYWELL MAKES ON THIS PRODUCT. THE DURATION OF ANY IMPLIED WARRANTIES, INCLUDING THE WARRANTIES OF MERCHANTABILITY AND FITNESS FOR A PARTICULAR PURPOSE, IS HEREBY LIMITED TO THE ONE-YEAR DURATION OF THIS WARRANTY. Some states do not allow limitations on how long an implied warranty lasts, so the above limitation may not apply to you.

This warranty gives you specific legal rights, and you may have other rights which vary from state to state.

If you have any questions concerning this warranty, please write Honeywell Customer Relations, 1985 Douglas Dr, Golden Valley, MN 55422 or call 1-800-468-1502. In Canada, write Retail Products ON15-02H, Honeywell Limited/Honeywell Limitée, 35 Dynamic Drive, Scarborough, Ontario M1V4Z9.

Honeywell

Automation and Control Solutions

Honeywell International Inc.
1985 Douglas Drive North
Golden Valley, MN 55422

Honeywell Limited-Honeywell Limitée
35 Dynamic Drive
Scarborough, Ontario
M1V 4Z9



Printed in U.S.A. on recycled paper containing at least 10% post-consumer paper fibers.