

1 Description

This thermostat can be used to control a electric heating system such as an baseboard heater, a radiant ceiling, a radiant floor, a convactor, etc. See minimum and maximum load requirement in section 5.

The thermostat cannot be used with the following:

- a resistive load under 2 A
- systems driven by a contactor or a relay (inductive load)
- fan-equipped heating systems
- central heating systems

SUPPLIED PARTS

- One (1) thermostat
- Two (2) 6-32 mounting screws
- Two (2) solderless connectors

2 Installation

TURN OFF POWER OF THE HEATING SYSTEM AT THE MAIN POWER PANEL TO AVOID ELECTRIC SHOCK.

Loosen the screw holding the control module to the base. The screw cannot be completely removed. Lift the control module to remove it from the base.

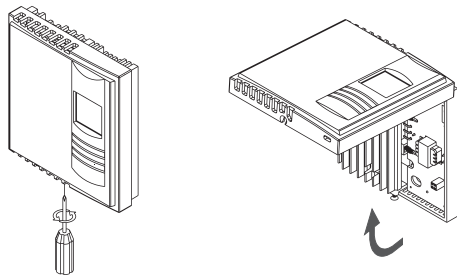

Make the appropriate connections. Please note that the thermostat wires are non-polarized; either wire can be connected to either terminal.

NOTE: All cables and connections must conform to the local electrical code. Special CO/ALR solderless connectors must be used when connecting with aluminium conductors.

2-wire installation

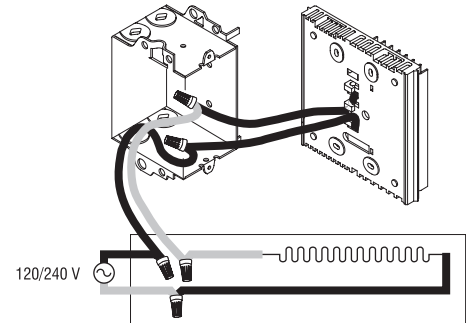

4-wire installation

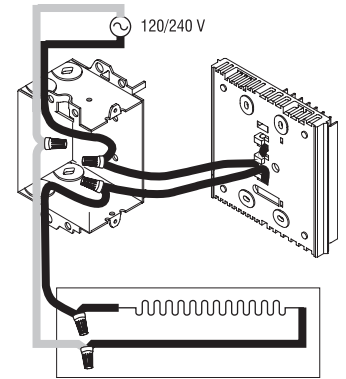

Align and affix the base to the electrical box.

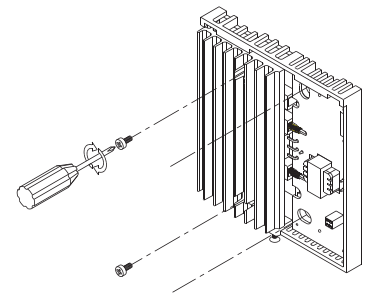

Set the switch at the back of the removable part of the thermostat to °C or °F.

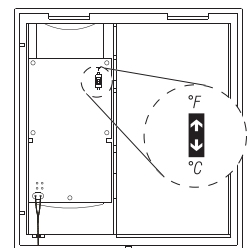

Replace the front part of the thermostat on the base and secure it in place with the screw.

Keep air vents of thermostat clean and free from obstructions.

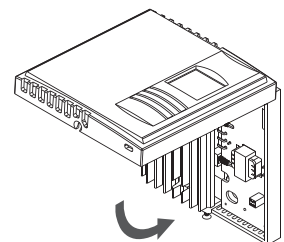

3 Temperature Display and Setting

The thermostat normally displays the actual (ambient) temperature.

- To view the setpoint temperature, press once on either of the temperature adjustment buttons. The icon  appears during the setpoint display.
- To change the setpoint temperature, press the appropriate button until the desired value is displayed.



4 Power Outage

During a power outage, the setpoint is stored in memory.

5 Specifications

- **Supply:** 120/240 VAC, 50/60 Hz
- **Minimum load:** 2 A (resistive only)
500 W @ 240 VAC
250 W @ 120 VAC
- **Maximum load:** 12.5 A (resistive only)
3000 W @ 240 VAC
1500 W @ 120 VAC
- **Display range:** 0 to 50°C (32 to 122°F)
- **Setpoint range:** 5 to 30°C (40 to 85°F)
- **Storage:** -20 to 50°C (-4 to 120°F)
- **Approval:** c UL us

6 Troubleshooting

| PROBLEM | SOLUTIONS |
|--|---|
| Thermostat is hot | This is normal. Under normal operation, the thermostat housing can reach a temperature between 35°C (95°F) and 40°C (104°F). |
| Heater is always On. | The thermostat has not been correctly wired. |
| Thermostat indicates that heating is On, but the heater is not On. | The thermostat has not been correctly wired. |
| Displayed temperature is wrong | The thermostat is exposed to air draft. Eliminate the draft. The sticker on the thermostat's screen has not been removed. |
| Display disappears and reappears after a few minutes | The thermal protection device on the heater is open. This can happen after a power failure or if the heater is obstructed by furniture or curtains. |
| Display looks faded when heating is activated | The heating system is less than the required minimum load. This thermostat cannot be used below that rating. |

Warranty

Honeywell warrants this product, excluding battery, to be free from defects in the workmanship or materials, under normal use and service, for a period of one (1) year from the date of purchase by the consumer. If at any time during the warranty period the product is determined to be defective or malfunctions, Honeywell shall repair or replace it (at Honeywell's option).

If the product is defective,

- return it, with a bill of sale or other dated proof of purchase, to the place from which you purchased it, or
- call Honeywell Customer Care at 1-800-468-1502. Customer Care will make the determination whether the product should be returned to the following address: Honeywell Return Goods, Dock 4 MN10-3860, 1885 Douglas Dr N, Golden Valley, MN 55422, or whether a replacement product can be sent to you.

This warranty does not cover removal or reinstallation costs. This warranty shall not apply if it is shown by Honeywell that the defect or malfunction was caused by damage which occurred while the product was in the possession of a consumer.

Honeywell's sole responsibility shall be to repair or replace the product within the terms stated above. HONEYWELL SHALL NOT BE LIABLE FOR ANY LOSS OR DAMAGE OF ANY KIND, INCLUDING ANY INCIDENTAL OR CONSEQUENTIAL DAMAGES RESULTING, DIRECTLY OR INDIRECTLY, FROM ANY BREACH OF ANY WARRANTY, EXPRESS OR IMPLIED, OR ANY OTHER FAILURE OF THIS PRODUCT. Some states do not allow the exclusion or limitation of incidental or consequential damages, so this limitation may not apply to you.

THIS WARRANTY IS THE ONLY EXPRESS WARRANTY HONEYWELL MAKES ON THIS PRODUCT. THE DURATION OF ANY IMPLIED WARRANTIES, INCLUDING THE WARRANTIES OF MERCHANTABILITY AND FITNESS FOR A PARTICULAR PURPOSE, IS HEREBY LIMITED TO THE ONE-YEAR DURATION OF THIS WARRANTY. Some states do not allow limitations on how long an implied warranty lasts, so the above limitation may not apply to you.

This warranty gives you specific legal rights, and you may have other rights which vary from state to state.

If you have any questions concerning this warranty, please write Honeywell Customer Relations, 1985 Douglas Dr, Golden Valley, MN 55422 or call 1-800-468-1502. In Canada, write Retail Products ON15-02H, Honeywell Limited/Honeywell Limitée, 35 Dynamic Drive, Scarborough, Ontario M1V4Z9.

Customer assistance

If you have any questions about the operation of your thermostat, please go to <http://yourhome.honeywell.com>, or call Honeywell Customer Care toll-free at **1-800-468-1502**.