

## M4™ SAMPLING VALVE

# USER MANUAL



## DOCUMENT VERSION LOG

The table below lists previous versions of this User Manual and states the major changes between versions.

This version list is introduced in November 2015.

<b>Version #</b>	<b>Version date</b>	<b>Major changes from previous versions</b>
1	September 2015	Latest version without version log
2	11 <sup>th</sup> November 2015	Various amendments to the text in 5, 5.1, 5.2, 6.3. Major change in Viscosity range in 6.6. A new chapter 6.7 Flow. Added Warning in 13.2. New chapter 13.3 about lubricating turn knob. New illustration in 14.

## **INTRODUCTION:**

**MANUFACTURER:** Keofitt A/S  
Kullinggade 31  
5700 Svendborg, Denmark

**TYPE:** M4™ SAMPLING VALVE

**PATENTS:** U.S. PAT. 5,246,204 • E.P. 0468957

**YEAR OF INTRODUCTION:** 1998

**YEAR OF REVISED DESIGN:** 2014

**LAST UPDATED:** Nov. 2015

The English version of this Manual is the governing version and it is the only authorized version. Consequently, KEOFITT cannot be held liable for other versions including translations of this Manual.



# CONTENTS

<b>1. PRESENTATION .....</b>	<b>7</b>
1.1 Definition of terms.....	7
1.2 Quick start.....	9
<b>2. CLEANING – DISINFECTION – STERILISATION .....</b>	<b>10</b>
2.1 Clean-In-Place (CIP).....	10
2.2 Disinfection.....	10
2.3 Sterilisation .....	11
<b>3. VALVE FUNCTION .....</b>	<b>12</b>
<b>4. EVERYDAY USE OF THE VALVE .....</b>	<b>14</b>
4.1 Pre-production treatment .....	14
4.2 Chemical cleaning, CIP .....	14
4.3 Chemical Disinfection .....	14
4.4 Steam sterilisation .....	14
<b>5. VALVE OPERATIONS .....</b>	<b>15</b>
5.1 Chemical CIP .....	15
5.2 Chemical disinfection .....	16
5.3 Steam sterilisation .....	18
5.4 Sampling.....	20
<b>6. TECHNICAL DATA .....</b>	<b>21</b>
6.1 Material.....	21
6.2 Certificate .....	21
6.3 Pressure (max.) .....	21
6.4 Temperature (max.).....	21
6.5 Surface finish .....	21
6.6 Viscosity:.....	21
6.7 Flow.....	22
<b>7. VALVE BODIES .....</b>	<b>23</b>
<b>8. VALVE HEADS .....</b>	<b>24</b>
<b>9. PARTS &amp; ACCESSORIES .....</b>	<b>25</b>
<b>10.MOUNTING INSTRUCTIONS .....</b>	<b>26</b>
10.1 Location.....	26
10.2 Before welding .....	26
<b>11. WELDING INSTRUCTIONS.....</b>	<b>27</b>
11.1 Welding method .....	27
11.2 Guideline welding values .....	27
<b>12. BLOCK DIAGRAMS.....</b>	<b>28</b>
12.1 Keofitt valve type T (tank).....	28
12.2 Keofitt valve type P (pipe).....	28
12.3 Keofitt valve type P (pipe connection vertical) Inline .....	29
12.4 Keofitt valve type clamp connection .....	29

12.5 Keofitt valve type Varivent®.....	30
12.6 Keofitt valve type thread .....	30
<b>13. MAINTENANCE.....</b>	<b>31</b>
13.1 Spare parts list.....	31
13.2 Disassembly and assembly of valve body and head.....	32
13.3 Disassembly of valve head .....	32
<b>14. INSTRUCTIONS ON REPLACING PTFE MEMBRANE .....</b>	<b>33</b>
<b>15. UPGRADE FROM SILICONE/EPDM TO PTFE MEMBRANE .....</b>	<b>34</b>
15.1 For manually operated valve heads type H, K and Q .....	34
15.2 For manually operated valve heads type B .....	35
15.3 For pneumatically operated valve heads type N .....	35
<b>16. MEMBRANES .....</b>	<b>37</b>
16.1 Silicone membrane - art. no. 400051.....	37
16.2 EPDM membrane - art. no. 400052 .....	38
16.3 PTFE membrane - art. no. 400055 .....	39

# 1. PRESENTATION

The Keofitt M4™ sampling valve can be readily cleaned and disinfected/sterilised as it meets both hygienic and process design requirements. Effective cleaning and disinfection/sterilisation of the sampling valve can be carried out between random samples independently of the course of the production process without compromising the same. The coaxial design and the electro polished valve interior ensure absolute cleanability.

The M4™ valve is 3-A authorised and EHEDG Type EL Class I certified. The American 3-A Sanitary Standard is normative for the component's ease of cleaning and sterilisation and ensures optimum conditions for food products, which comes in contact with the component in question. The European EHEDG Type EL certificate is issued based on the cleanability of the valve and the test method is an indicator of good inherent hygienic equipment design.

Keofitt valves are used in a wide range of processing industries, such as breweries, dairies, juice/soft drinks and the biotechnological and pharmaceutical industries.

## 1.1 Definition of terms

In order to ease the reading of this manual and to avoid any misunderstanding, please refer to the definition of terms in the table below:

<b>TERM</b>	<b>DEFINITION</b>
3-A Sanitary Standard	3-A SSI is an independent, not-for-profit US corporation dedicated to advancing hygienic equipment design for the food, beverage and pharmaceutical industries.
Acids	An acid is a chemical substance whose aqueous solutions are characterized by a sour taste and the ability to react with bases and certain metals (like calcium) to form salts. Aqueous solutions of acids have a pH of less than 7. A lower pH means a higher acidity, and thus a higher concentration of positive hydrogen ions in the solution. Removes limestone and most mineral deposits.
Alkali	Alkalis are all bases, which form hydroxide ions (OH <sup>-</sup> ) when dissolved in water. The terms “base” and “alkali” are often used interchangeably. Alkalis have a pH value above 7. Alkalis dissolves fat and oil, destroys protein and attacks light metal.
Aseptic sampling	The process of withdrawing a sample from the production equipment through a closed circuit, which has been sterilised and kept sterile with no exposure to the ambient during the sampling process.
Bioload	See Microbial load.
Bioburden	See Microbial load.
Chemical Sterilant	A few disinfectants will kill spores with prolonged exposure times (3–12 hours); these are called chemical sterilants.
Chlorine	Chlorine is a chemical element with symbol Cl and atomic number 17. It belongs to the halogen group together with for instance iodine. It is a strong oxidizing agent and reacts with many substances. These properties make chlorine compounds efficient disinfectants.
CIP	Abbreviation of Clean-In-Place. The process of cleaning a process component (like a sampling valve) without removing it from the production line.
Cleaning	Removal, usually with detergent and water or enzyme cleaner and water, of adherent visible soil on a surface.

Complexing agent	A substance capable of forming a complex compound with another material in solution. Improves the cleaning properties of a detergent.
Contact time	The time span during which the item is in contact with the detergent or the disinfectant.
Enzymes	Molecules, which are added to cleaning agents to ease the removal of specific organic material. Assures same cleaning effect at a lower temperature.
Disinfectant	Usually a chemical agent that destroys harmful microorganisms but might not kill bacterial spores.
Disinfection	Thermal or chemical destruction of microorganisms. Disinfection is less lethal than sterilisation, because it destroys most recognised microorganisms but not necessarily all microbial forms (e.g. bacterial spores).
Detergent	A cleaning agent that has no antimicrobial effect, but in diluted solutions good cleaning properties.
EHEDG	Abbreviation for the European Hygiene Engineering and Design Group. EHEDG is a consortium of equipment manufacturers, food industries, research institutes as well as public health authorities promoting safe food by improving hygienic engineering and design in all aspects of food manufacture.
Electro polishing	Electro polishing is an electrochemical process by which the high points within the microscopic surface texture are removed and the corners rounded. This results in Reduced Product Adhesion, Ease of Cleaning and Improved Corrosion Resistance.
Exposure time	Period in a sterilisation/disinfection process during which the item is exposed to the sterilant/disinfectant at the specific sterilisation/disinfection parameters.
Flow path	The path the sample flows from the tank or process equipment to the sample recipient.
Germicidal	The property of an agent to destroy microorganisms.
Microbial load	The number and types of viable microorganisms with which an item is contaminated; also called bioload or bioburden.
Microorganisms	Animals or plants of microscopic size. As used in food and pharmaceutical industries, generally refers to bacteria, fungi, viruses and bacterial spores.
Peracetic acid	A commonly used disinfectant, which is efficient at low temperature and short contact time. Relatively harmless as it decomposes into carbon dioxide (CO <sub>2</sub> ) and water (H <sub>2</sub> O).
Process media	The product in the process equipment and the product from which a sample is taken.
Representative sample	A sample which when it reaches the laboratory is still identical to the process media. A sample which is in no way contaminated or altered during neither the sampling process nor the transport to the laboratory.
Sanitization	The application of a chemical agent that reduces the number of bacterial contaminants to a safe level as judged by the public health authorities. The official sanitizer protocol indicates that 99.999% of the specific test bacteria be killed in 30 seconds under the conditions of the test.
SIP	Abbreviation for Sterilise-In-Place. The process of rendering a process component (like a sampling valve) sterile without removing it from the production line.



Spores	Relatively water-poor resting cells surrounded by an impervious cell wall, which makes them relatively resistant to disinfectants and sterilants. They are dangerous as they can survive in adverse conditions and re-emerge as live bacteria at a later stage.
Sporicidal	The property of an agent that kills spores.
Steaming	The process of using saturated steam under pressure as the sterilising agent.
Sterile	State of being free from all living microorganisms. In practice, usually described as a probability function, e.g., as the probability of any microorganism surviving sterilisation being one in one million.
Sterilant	A few disinfectants will kill spores with prolonged exposure times (3–12 hours); these are called chemical sterilants.
Sterilisation	Validated process used to render an item free of all forms of viable microorganisms. In a sterilisation process, the presence of microorganisms is expressed in terms of probability. Although this probability can be reduced to a very low number, it can never be reduced to zero.
Sterility Assurance Level	The probability of a viable microorganism being present on an item after sterilisation. Usually expressed as $10^{-n}$ ; a SAL of $10^{-6}$ means <1/1 million chance that a single viable microorganism is present on a sterilised item.
Tensides	A tenside is a surfactant that reduces the surface tension of water and assures a faster and better contact between the detergent and the soil.

## 1.2 Quick start

The table below gives you an overview of the relevant chapters to read depending on the operations you want to perform to obtain the required hygienic level.

Required hygienic level	4.1 Pre-production treatment	4.2 Chemical cleaning CIP	4.3 Chemical disinfection	4.4 Steaming	5.1 Chemical CIP	5.2 Chemical disinfection	5.3 Steam sterilisation	5.4 Sampling
<b>Cleaning</b>	✓	✓			✓			✓
<b>Disinfection</b>	✓		✓			✓		✓
<b>Sterilisation</b>	✓			✓			✓	✓

## 2. CLEANING – DISINFECTION – STERILISATION

### 2.1 Clean-In-Place (CIP)

Thorough cleaning of the valve is a prerequisite for proper disinfection or sterilisation. Cleaning of the valve is the removal of any visible residual product, it be organic or inorganic. It may be done using either steam (continuous steam will eventually lead to sterility; SIP = Sterilise-In-Place) or a suitable liquid detergent.

Cleaning is the removal of adhering soil from the environment and from the previous sample (to the extent it has not been removed by the recommended post-sample cleaning). Cleaning is usually performed by flushing with water followed by a thorough washing with an appropriate detergent and finished off with a thorough rinsing with water.

Depending on the actual process media the proper detergent must be determined in cooperation with your usual supplier of detergents. The company Novadan ApS, Kolding, Denmark - [www.novadan.dk](http://www.novadan.dk), has supplied the generic table below for your convenience.

What to clean for	Generic cleaning agents	Comments
Fat	Alkali and Tensides	Heat will facilitate the cleaning process as the fat melts
Protein	Alkali, Acids, Tensides and Chlorine	Coagulation and burning when heated, which makes the product hard to remove.
Sugar, Salt	Water is usually sufficient as the product is water soluble	Sugar caramelises when heated, turning into a hard sticky substance, which is difficult to remove
Minerals	Acids, Complexing agent	Often seen as lime scale
Biofilm	Alkali and Chlorine, Peracetic acid, possibly Enzymes	Biofilm is an accumulated mass of microorganisms that is tightly adhered to a surface and cannot be easily removed.
Starch	Alkali and Chlorine	

### 2.2 Disinfection

Although CIP removes all visible residues of the process media the valve surfaces will still be contaminated on a microscopic level. Depending on your actual process media it will be necessary to carry out a disinfection operation in order to a) reduce the microbial load to an acceptable level (also referred to as Sanitization) or b) destroy critical microorganisms, but not necessarily all microbial forms (e.g. bacterial spores).

The disinfection process may be carried out in one of two ways and to different levels of disinfection depending on a) the initial microbial load distribution, b) the required hygienic level and c) the type, exposure time and concentration of the chemicals used (if using a chemical disinfectant):

- By steaming (in a continued process after steam cleaning)
- By applying one or more suitable liquid chemical disinfectants

There are a number of chemical disinfectants. It is important to choose the right one, the right concentration and contact time and the right method for your current application. Your usual supplier of chemical disinfectants can support you in choosing the right disinfectant for your process media and the specific group of microorganisms you are aiming at.

The company Novadan ApS, Kolding, Denmark has supplied the table below, as a preliminary indication of which type of disinfectant to use:

Disinfectant \ Microbes to inactivate	<b>Halogenes</b> (Chlorine)	<b>Peroxides</b> (hydrogenperoxid & peracetic acid)	<b>Alcohol</b> (70%)
<b>Gram-neg bacteria</b> Salmonella Campylobacter E. Coli and others...	Efficient	Efficient	Efficient
<b>Gram-pos bacteria</b> Listeria Bacillus cereus Clostridium and others...	Efficient	Efficient	Efficient
<b>Bacteria spores</b> Bacillus cereus and others...	Limited effect	Efficient	Little/No effect
<b>Bacteriophage</b>	Limited effect	Efficient	Little/No effect
<b>Yeast</b>	Efficient	Efficient	Efficient
<b>Fungi</b>	Efficient	Efficient	Limited effect
<b>Virus</b>	Efficient	Efficient	Limited effect

Legend: Efficient Limited effect Little/No effect

**NOTE!** The final choice of detergent, disinfectant and method lies with the user, supported by the supplier of the CIP fluids and disinfectants, as it is very much dependant on individual concerns and circumstances.

## 2.3 Sterilisation

Sterilisation is a high-level disinfection designed to render the valve free of all forms of viable microorganisms (incl. bacterial spores) to a high level of certainty; the so-called Sterility Assurance Level or SAL. A SAL value of 10<sup>-6</sup> means that the probability (or risk) of a single viable microorganism being present on the valve interior afterwards is only 1 in 1,000,000 which is a generally accepted level for calling an item sterile. Although the probability can be reduced to a very low number, it can never be reduced to zero.

Sterility may in practise only be obtained by steaming. Disinfectants exist that in high concentrations and for a prolonged exposure time will be able to inactivate all forms of microorganisms and render the valve interior sterile with a high probability; these disinfectants are called chemical sterilants. However, the application of chemical sterilants is most often problematic due to a) a required high concentration, which causes an operator hazard and b) the several hours of exposure time.

**NOTE!** Furthermore, sterilisation with a chemical sterilant may not convey the same sterility assurance as sterilisation with steam, because the germicidal and sporicidal kinetics are much less investigated and documented for chemical sterilants compared to steam.

### 3. VALVE FUNCTION

The valve is designed to regularly take representative samples in the production process. The valve is therefore designed such that effective cleaning, disinfection/sterilisation and sampling can be carried out regularly without interrupting the production process.

**NOTE!** The membrane functions as a dynamic seal in the valve seat as well as a hygienic static sealing against the valve head.

The table below describes the two fundamentally different ways of preparing the valve for sampling, 1) Chemical cleaning/disinfection and 2) Steaming:

	Method	Description	Pros & Cons
Chemical	<b>Chemical cleaning</b>	Liquid detergents are used to clean the valve. CIP = Clean-In-Place	This process is adopted where steam is not available or where the product cannot withstand the exposure to heat. Involves several stages with flushing, cleaning and rinsing between batches.
	<b>Chemical disinfection</b>	A disinfection process using an appropriate chemical liquid disinfectant usually follows the cleaning process. The valve interior is wetted, soaked or flushed with an appropriate disinfectant.	It adds 2 more stages to the CIP: application of disinfectant and final rinse. Involves handling of potentially hazardous chemicals.
Thermal	<b>Sterilisation</b>	Steam is supplied for 1 minute just before and immediately after sampling.	Steaming does flushing, cleaning, rinsing and sterilisation in one operation. Steaming is not suitable with heat sensitive products. Steaming entails the risk of burns.

Flushing with water followed by the supply of a chemical detergent through the upper of the valve's two hose pieces results in cleaning the valve (CIP). It is the perfect, hygienic design and surface finish of the inner part of the valve, which enables easy, efficient and reliable cleaning in a closed state of the valve. Supplying steam through the upper of the valve's two hose pieces results in cleaning and sterilisation. It is the perfect, hygienic design and surface finish of the inner part of the valve, which enables sterilisation in a closed state. According to an EHEDG based test conducted by the Biotechnological Institute in Denmark, the valve is sterile after just 1 minute's supply of steam at a pressure of 1 bar(g), 121 °C. Steaming is therefore a SIP process (Sterilise-In-Place).

Following CIP or SIP, but prior to sampling, a sterile plug of rubber or stainless steel is fitted to the top hose piece. When the valve is opened the process product will run out of the lower hose piece.



#### WARNING

- During sterilisation with steam the valve will become hot and care should thus be taken when operating the valve
- The valve is designed for use in working conditions of up to 6 bar(g) pressure and temperatures of up to 121 C. It is therefore important to be aware that the rubber plug (designed for max. 3 bar(g)) or the steel plug (designed for max. 10 bar(g)) may be forced out at high speed, if not seated properly
- When steaming always use dry saturated steam without condensation at max. 1 bar(g). At

higher pressure the membrane may be damaged/split

- Always remember to use safety goggles when steaming, CIPping, taking samples and all other operations of the sampling valve



### **IMPORTANT**

- The valve cannot be used for vacuum since the membrane will be sucked hard into the seat and the valve will not function properly
- The membrane is available in 3 different qualities: Silicone, EPDM and PTFE
- The Silicone membrane has the advantage that it in general can withstand high temperatures, but it cannot tolerate moisture condensation resulting from steam sterilisation
- The EPDM membrane is better able to cope with the condensation in the steam and at the same time it can be used with a majority of CIP fluids and disinfectants in normal concentrations
- The PTFE membrane resists all CIP fluids and disinfectants except highly oxidising acids in high concentrations

## 4. EVERYDAY USE OF THE VALVE

This chapter gives an introduction to how the sampling valve works in different operating conditions. For specific operator instructions please refer to the chapter “VALVE OPERATIONS”.

### 4.1 Pre-production treatment

Before every new production batch the sampling valve is cleaned and disinfected/sterilised together with the tank or vessel or the entire production line.

Make sure the valve is in its open position during the initial line CIP to allow cleaning of the valve seat and the membrane contact surface.

Also allow CIP fluid, disinfectant or steam to flow through the inlet and outlet hose pieces.

Remember to close the valve after the final rinse and prior to starting up the next production batch.

### 4.2 Chemical cleaning, CIP

During production and prior to sampling, cleaning takes place with the valve closed and involves the following stages:

**1. Pre-rinse**

Flushing with water to mechanically remove product residues

**2. Clean**

Applying a detergent to remove remaining visible product residues

**3. Final rinse**

Rinse with clean water to remove all traces of detergents

Usually this procedure is followed by disinfection (see below), but for some application CIP might be sufficient. It depends on your (microbiological) requirements, the detergents applied and the process media to clean for. Consult your supplier of CIP fluids.

In some cases where the process media is for instance water, CIP might not even be necessary and you may go directly to disinfection.

### 4.3 Chemical Disinfection

Disinfection takes place with the valve closed and involves the following stages of which the first 3 are identical to CIP:

**1. Pre-rinse**

Flushing with water to mechanically remove product residues

**2. Clean**

Applying a detergent to remove remaining visible product residues

**3. Intermediate rinse**

Rinse with clean water to remove all traces of detergents

**4. Disinfection**

Apply an appropriate disinfectant targeting one or more or all microorganisms

**5. Final rinse**

Rinse with cleaned water to remove all traces of the disinfectant

### 4.4 Steam sterilisation

Steaming has the advantage that it does flushing, cleaning and sterilisation in one operation. However the heat from the steam will cause sugary substances to caramelize and substances containing protein to coagulate and burn; see chapter 2.1. In this case flushing with an appropriate fluid must precede post-sampling steaming.

If steaming is the preferred procedure, but no steam is installed near the sampling point, an option is to use a portable steam generator. Keofitt supplies fittings for a Kärcher steam generator. The steaming process with a Keofitt sampling valve has been validated to obtain sterility after 1 minute of steaming at 121° C (1 bar(g)). Documentation is available at the Keofitt Online Service Center on [www.keofitt.dk](http://www.keofitt.dk).

## 5. VALVE OPERATIONS

This chapter provides clear instructions on how to operate the sampling valve in different situations. Before sampling the valve must be cleaned followed by disinfection or sterilisation, depending on your requirements.

For the initial cleaning before a new batch please refer to chapter 4.1 Pre-production treatment.





### IMPORTANT

- All illustrations show a sampling valve with Keofitt hose piece connections. All instructions also apply to valve versions with clamp connections; only make sure to use the corresponding fittings.

### 5.1 Chemical CIP

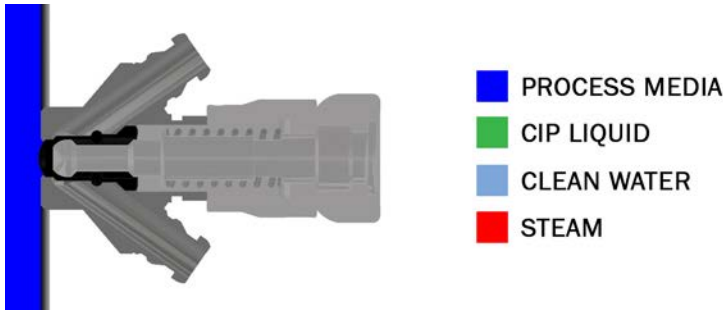
The CIP takes place with the valve remaining in its closed position. Perform the following steps:

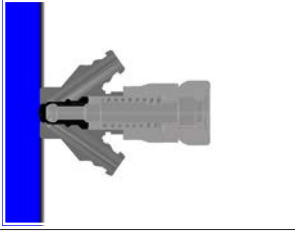

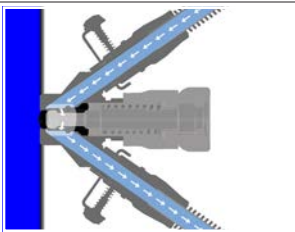
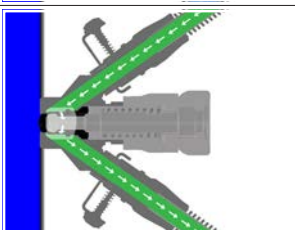
1.	Remove the plugs. In the case of a valve with clamp connections there are no plugs supplied.	
2.	Connect a water hose to the upper hose piece.	
3.	Connect a hose to the lower hose piece and let the hose go to a drain.	
4.	Flush with clean water.	
5.	Remove the water hose and let the CIP liquid flow through the upper hose piece. If the CIP liquid must not go to drain, circulate it or collect it in a suitable container and dispose of correctly.	

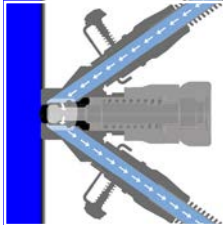
<p>6. Reconnect the water hose to the upper hose piece and rinse with clean water.</p>	
--	---

If disinfection is not needed the valve is now ready for taking a sample. If disinfection is required proceed with the steps mentioned in the section “Chemical disinfection” below. Flush with clean water after sampling. If the process media is sticky, viscous or aggressive or for any other appropriate reason, do repeat the full CIP cycle after sampling.



**WARNING**

- Carefully follow the guidelines given for the chemicals involved
- Always remember to use safety goggles when steaming, CIPping, taking samples and all other operations of the sampling valve

## 5.2 Chemical disinfection

Immediately following the CIP, perform the disinfection, if required. The disinfection takes place with the valve remaining in its closed position.

There are 2 recommended ways to carry out the disinfection:

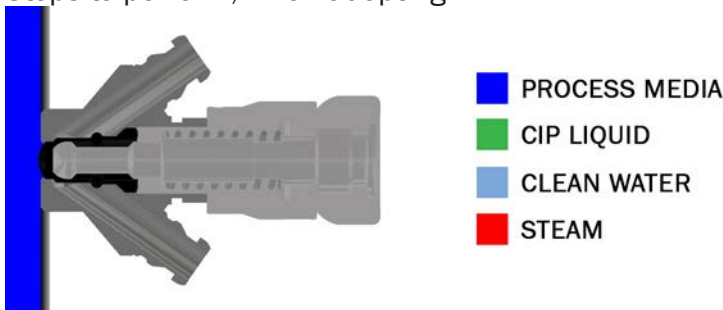

- A) by letting the disinfectant flow through the valve chamber
- B) by filling the valve chamber with the disinfectant (advantage: smaller volume of disinfectant needed and quicker and more reliable disinfection)

Steps to perform, when adopting A:

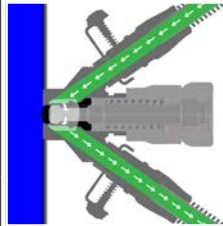



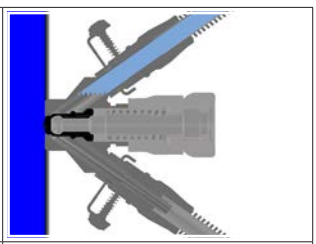

<p>1. Connect a hose with an empty bottle to the lower hose piece. This bottle or similar recipient is to collect the disinfectant (step 3) and the rinsing water (step 6).</p>	
<p>2. Fill a flexible bottle with the defined amount of disinfectant.</p>	
<p>3. Connect the flexible bottle via a hose to the upper hose piece and press the disinfectant slowly through the valve to wet the interior of the valve.</p>	
<p>4. Allow the disinfectant to act for the prescribed time.</p>	

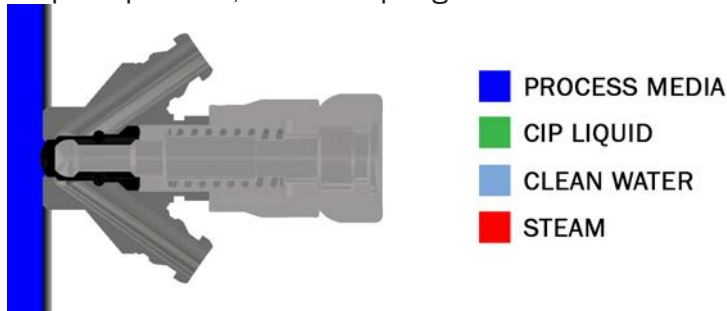

5.	Disconnect the hose from the upper hose piece and connect a flexible bottle with cleaned water to the upper hose piece.	
6.	Rinse through the upper hose piece by squeezing the bottle, thus pressing the water through the valve chamber.	
7.	Leave the squeezed bottle connected to the hose piece and clamp the hose to avoid contamination from air being sucked in through the valve.	

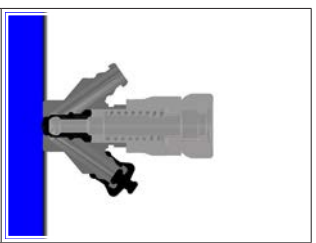
Steps to perform, when adopting B:

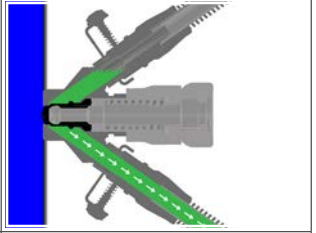

1.	Plug the lower hose piece with a rubber plug (or a steel plug). In case of a valve with mini clamp connections the closing of the outlet may be obtained by using a tri clamp blind cap or by squeezing an attached piece of tubing or by any other appropriate means.	
2.	Fill the valve chamber with the disinfectant through the upper hose piece.	
3.	Leave to act for the prescribed time.	
4.	Empty the valve chamber by unplugging the lower hose piece while holding a recipient under the valve allowing the disinfectant to flow out.	
5.	Connect a flexible bottle with cleaned water to the upper hose piece and rinse through the upper hose piece.	
6.	Leave the squeezed bottle connected to the upper hose piece and clamp the hose to avoid contamination from air being sucked in through the valve.	

The valve is now ready to take a sample. The sampling must be performed immediately after disinfection to avoid any contamination of the sample.

Flush with water after sampling. If the process media is sticky, viscous or aggressive or for any other

appropriate reason, do repeat the full CIP cycle after sampling.



**WARNING**

- Carefully follow the guidelines given for the chemicals involved
- Always remember to use safety goggles when steaming, CIPping, taking samples and all other operations of the sampling valve

### 5.3 Steam sterilisation

Chemical CIP and chemical disinfection are not needed when using steam, as steam does it all. An exception from this is with sugary substances, which caramelise and with substances containing protein, which coagulate and burn; see chapter 2.1. In this case flushing with an appropriate fluid must precede post-sampling steaming.

Steam sterilisation takes place with the valve remaining in its closed position. Perform the following steps:

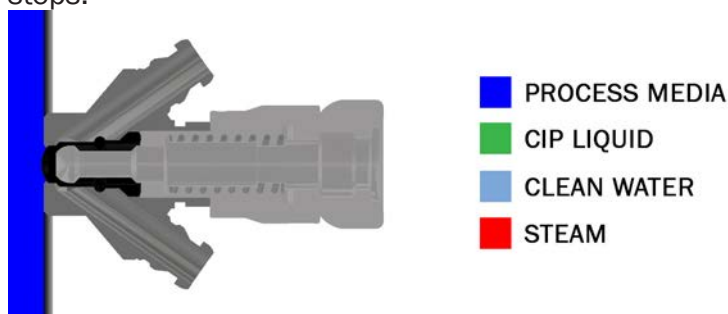

1.	Remove the plugs from the hose pieces	
2.	Connect the steam hose to the valve's upper hose piece	
3.	Connect a hose to the lower hose piece and let it go to drain	
4.	Open the steam supply and let it flow through the valve for sterilisation. Allow 1 minute at 121 C (1 bar(g))	
5.	Close the steam supply, but leave the hose in place to prevent contamination from the ambient during sampling. If removal of steam hose is required, fit a sterile rubber or stainless steel plug onto the upper hose piece	

The valve is now ready to take a sample. The sampling must be performed immediately after steaming to avoid any contamination of the sample.



## **WARNING**

- During sterilisation with steam the valve will become hot and care should thus be taken when operating the valve
- The valve is designed for use in working conditions of up to 6 bar(g) pressure and temperatures of up to 121 C. It is therefore important to be aware that the rubber plug (designed for max. 3 bar(g)) or the steel plug (designed for 10 bar(g)) may be forced out at high speed, if not seated properly
- For valve heads allowed under ATEX for Group IIGD, Category 2 (zone 1) both handle and top of valve heads N and Q must be cleaned before use
- Always remember to wear safety goggles when steaming, Clipping, taking samples or any other operations of the sampling valve



## **IMPORTANT**

- Don't attach a steam trap to the hose from the valve steam outlet (lower hose piece) as it will impede the flow of steam and hence the flushing effect, and make the sterilisation dependant on temperature only, demanding a much longer sterilisation time
- If the steam capacity is low and/or the outlet hose from the valve is short and/or with a large diameter, the temperature will drop and condensation may occur in the valve chamber. In this case a counter pressure must be established using a pressure relief valve or a needle valve at the outlet
- Leave the steam hose in place to prevent contamination from the ambient during sampling. If removal of steam hose is required, fit a sterile rubber or stainless steel plug onto the upper hose piece

## 5.4 Sampling

Prepare a recipient for your sample.

**For aseptic sampling** use steam and a Keofitt Aseptic Sampling Bag (available in different sizes; please see datasheet on [www.keofitt.dk](http://www.keofitt.dk)). Leave the steam hose in place to prevent contamination from the ambient during sampling.

**For all other sampling** use a Keofitt Sterile Sampling Bag or a Spike Bag, which provides a closed flow path for your sample protected against the ambient. Alternatives are bottles with a screw cap, jars or any other available container. If removal of steam/CIP hose is required, fit a sterile rubber or stainless steel plug onto the upper hose piece

Take the sample immediately after cleaning/disinfection/sterilisation performing the following steps:

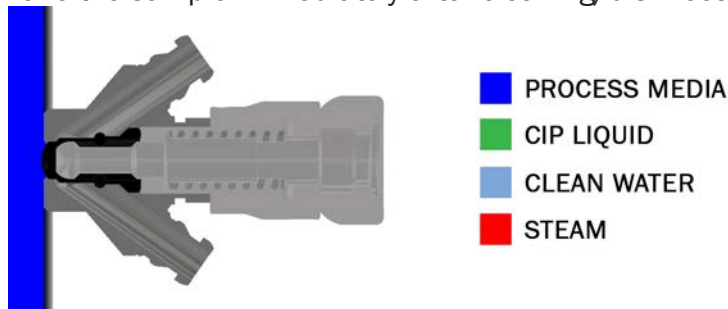

1.	Open the valve slowly and take the sample	
2.	Close the valve after the sample has been taken	
3.	Clean the valve by flushing with steam, water or hot water	

If the process media is sticky, viscous or aggressive or for any other appropriate reason, do repeat a full CIP cycle after sampling in case steam is not available and flushing with water prove insufficient.



### WARNING

- When sampling at a high pressure and/or with a low viscosity process media it may flow rapidly into the sample recipient. Therefore open the valve slowly. Special care must be taken with pneumatically operated valves, as they open abruptly
- Always remember to wear safety goggles when steaming, CIPping, taking samples or any other operations of the sampling valve

## 6. TECHNICAL DATA

### 6.1 Material

Valve body:	AISI 316L (1.4404)
Valve head:	AISI 316L (1.4404)
Membrane:	Silicone (grey) EPDM (black) PTFE (white)

### 6.2 Certificate

Valve body:	3.1
Membrane:	Silicone acc. to FDA & BGA EPDM acc. to FDA & BGA PTFE acc. to FDA & BGA

\* A 6-digit code is marked on the valve body. This code refers to a 3.1 certificate which accompanies every consignment of valve bodies. The 3.1 certificate is available at the Keofitt Online Service Center on [www.keofitt.dk](http://www.keofitt.dk). Click Certificates and then 3.1.

### 6.3 Pressure (max.)

Working pressure:	6 bar(g) / 87 psi(g)
Rubber plug	3 bar(g) / 44 psi(g)
Steel plug	15 bar(g) / 218 psi(g)

### 6.4 Temperature (max.)

Sterilisation temp.: 121°C / 250°F \*\*

\*\* It is important that the steam is saturated, but dry, as condensation can damage the membrane. (Dry steam at max. 1 bar(g)).

### 6.5 Surface finish

Internal:	Electropolished Ra<=0.5µm / 20µinch Ra(mean) = 0.2µm / 8µinch Ra(std.deviation) = 0.08µm / 3µinch Valves with internal electropolishing are identified by an E preceding the serial number e.g. E12345678
External:	Electropolished The surface roughness is measured for each valve at 4 critical places. A serial number identifies each valve body. A specific surface roughness certificate is supplied with every valve. A general surface finish certificate copy is available on <a href="http://www.keofitt.dk">www.keofitt.dk</a>

### 6.6 Viscosity:

Viscosity range: 0-100cP, with particles up to 1,5 mm in diameter.  
Higher viscosity liquids may be sampled, only will the sampling take longer.

## 6.7 Flow

The graphs below illustrate (for water at 20 °C/68 °F) the following:

- Pressure drop across valve as a function of the flow for different positions of the turn knob
- Pressure drop for flow between the inlet and outlet ports (CIP ports)

Based on the tank pressure and the requested sample flow the graphs may be used to get an indication of to which degree the valve must be opened.

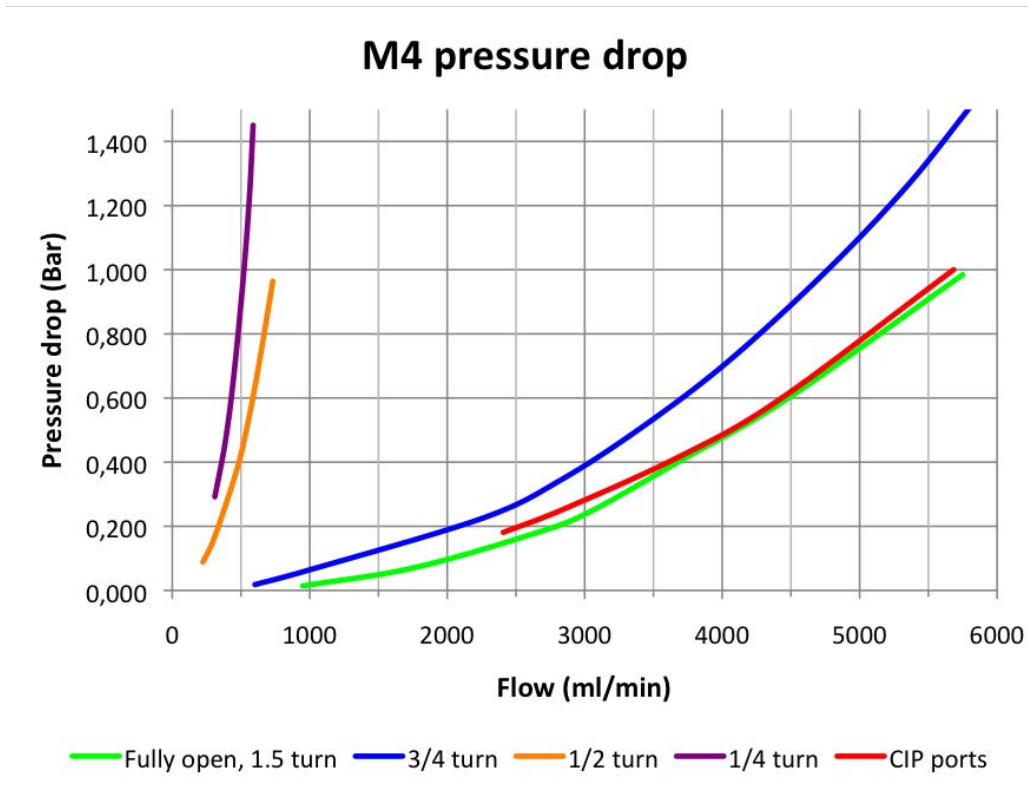

The generally accepted sampling time is around 10 sec. for small samples and around 30 sec. for larger samples. As usual sample sizes are between 100 ml and 1000 ml the needed flow lies from 600 to 2000 ml/min.

As the pressure on the sample side usually is 0 bar(g) the pressure drop across the valve equals the process pressure (tank pressure or line pressure).











The volume flow through a valve is given by:

$$k_v = Q \sqrt{\frac{\rho}{1000 \times \Delta p}}$$

Symbol	Unit	Description
$k_v$	m <sup>3</sup> /h	Flow in m <sup>3</sup> /h through a valve at a pressure drop of 1 bar as defined in VDE/VDI norm 2173.
$Q$	m <sup>3</sup> /h	Volume flow through the valve
$\rho$	kg/dm <sup>3</sup>	Density of the fluid. For Water it is 1.
$\Delta p$	bar	Pressure drop across valve. As the gauge pressure at the valve outlet usually is 0 bar(g) the pressure drop is often equal to the gauge pressure at the input (the process side)

# 7. VALVE BODIES

## KEOFITT CLASSIC M4 SAMPLING VALVE - BODIES

M4 BODIES				
	Hose Piece			
WELDING BODIES	Tank Welding G28	 400001	Not available	
	Pipe Welding 1"	 400011	Not available	
	Pipe Welding MWS	 400014	Not available	
	In-Line Vertical	 400027*	Not available	
	In-Line Horizontal	 400028*	Not available	
	CONNECTION BODIES	Variport Ø50	 400010	Not available
		Variport Ø58	 400009	Not available
		Clamp 1/2"	 400021	Not available
		Clamp 1"	 400022	Not available
		Thread M28x1,5	 400031	Not available
	Thread M12x0,75		Not available	
	Mini Tri-Clamp		Not available	

\* ON REQUEST ONLY!

For further product information - material, dimensions etc. - please refer to the specific datasheet at [www.keofitt.dk](http://www.keofitt.dk)

# 8. VALVE HEADS

## KEOFITT CLASSIC M4 SAMPLING VALVE - HEADS









M 4 HEADS		Type H Turn knob 0-6 bar (g)	Type K Key ring 0-6 bar (g)	Type O Lever handle 0-6 bar (g)	Type N Pneumatic 0-6 bar (g)	Type N Pneumatic, Adjustable 0-6 bar (g)	Type B No spring 0-12 bar (g)
Silicone	400041	400042	400043	400044	400045	400047	400047
EPPM	400041E	400042E	400043E	400044E	400045E	400047E	400047E
PTFE	405541	405542	405543	405544	405545	405547	405547

For further product information - material, dimensions etc. - please refer to the specific datasheet at [www.keofitt.dk](http://www.keofitt.dk)



# 9. PARTS & ACCESSORIES

## KEOFITT CLASSIC M4 - PARTS & ACCESSORIES

M4™ PARTS & ACCESSORIES						
O-Ring	 400208 O-RING 68 FDA	 400051 M4 SILICONE	 400013 QC-SPRUE M4	 550003 PTFE W/QC 1.0M	 400076 KEY RING M4	 400064 CHAIN M4
	 400308 EPDM 42X3 FDA	 400052 M4 EPDM	 400058 COIL M4	 550057 ADAPTOR KÄRCHER	 400149 BUSHING M4	 400067 HOSE P. 10/8 M4
	 400820 EPDM 15.6X2.4 FDA	 400055 M4 PTFE	 400059 PRV M4		 400255 TOOL PTFE M4	 400073 FERRULES
	 400830 SILIC. 5.3X2.4 FDA		 400061 QC PLUG M4		 600170 Q HANDLE	 900008 SOCKET ALU
	 400830E 5.3X2.4 EPDM		 400062 RUBBER CAP M4		 900018 TOMMY BAR	 900048 PTFE 8/6
	 550184 O-RING FESTO		 400070 QC M4 PIPE			 900086 CLAMP 1"
	 600825 SILIC. 7.1X1.6 FDA		 400071 QC M4 PTFE			
	 800859 7.5X2.5 SILIC		 400083 QC M4 MINI TC			
	 900074 GASKET 3/4"		 400084 QC M4 ID 4MM			
	 900091 GASKET 1"		 400085 QC M4 ID 5MM			
	 900820 5.1X1.6 SILICONE		 400086 QC M4 W9 H.P.			
	 900829 21X4 EPDM		 550002 PTFE W/QC 0.5M			

For further product information - material, dimensions etc. - please refer to the specific datasheet at [www.keofitt.dk](http://www.keofitt.dk)

## 10.MOUNTING INSTRUCTIONS

### 10.1 Location

The valve should always be located with its centre line in a horizontal position and with the two hose pieces in a vertical position with the arrow pointing upwards as shown on the figure. Only with this orientation the valve will be self draining.

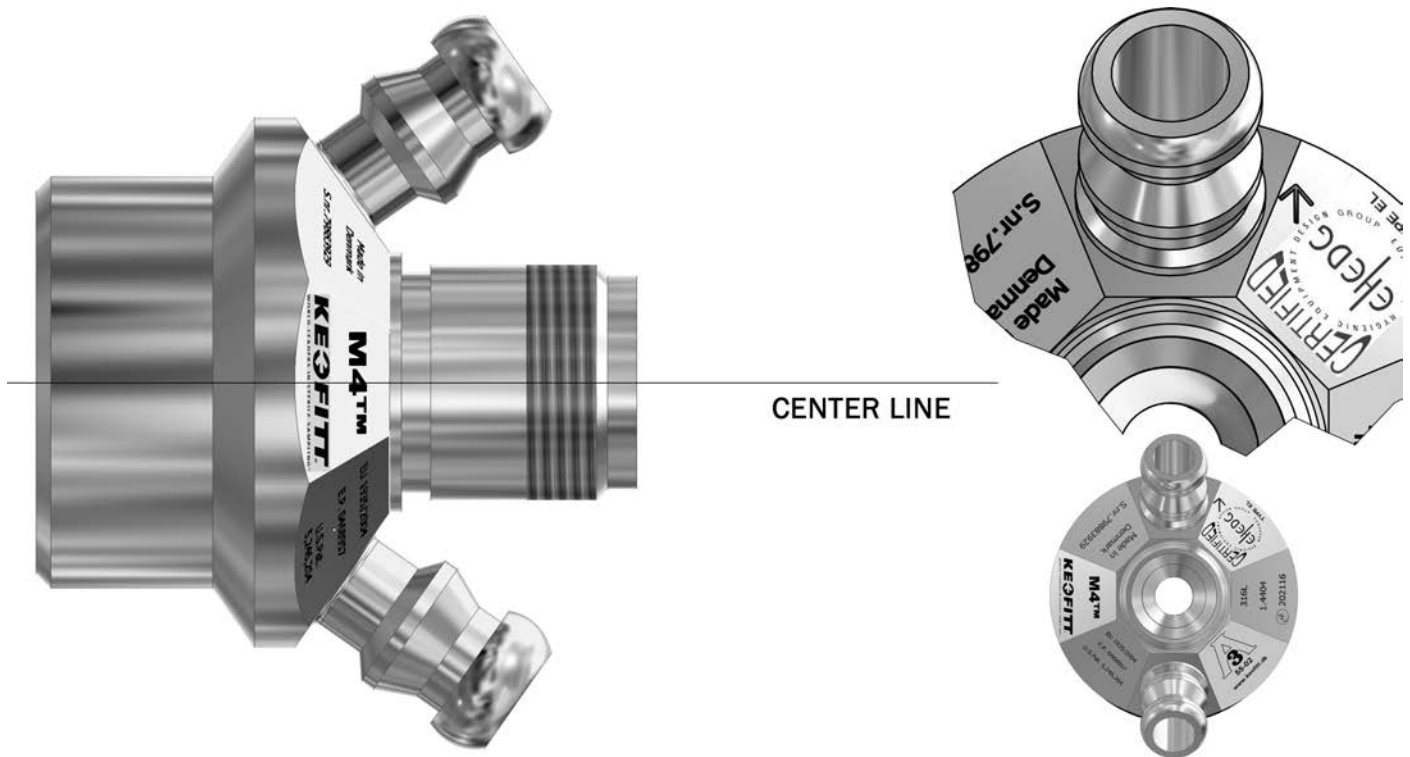

### 10.2 Before welding

Remember to disassemble the valve body and head. The valve body and head must be separated during welding. Rubber plugs, chain and membrane must be removed from the valve body, as otherwise heat from the welding process will damage them.

# 11. WELDING INSTRUCTIONS

Valves for welding are available in two types: T (tank) and P (pipe).

1. For type T (tank) it is necessary to drill a hole  $\varnothing 28$  mm into the tank wall, and then fit the valve into this hole flush with the inside of the tank. Welding should be carried out as a penetration welding.  
Material thickness less than 4 mm: Weld from inside. Material thickness greater than 4 mm: Weld from both outside and inside.  
Since type T has a solid end piece, the valve will not be damaged by penetration welding. However, the use of purge gas in the form of either Argon or Formier gas is recommended in order to give the best result.
2. For type P (pipe) penetration welding must be carried out from outside. The valve is machined with a recess-like shoulder on the outside of the end piece which gives approximately the same material thickness (1.5mm material thickness) as in the pipe wall. This machined shoulder can be modified according to the customer's wishes.



## IMPORTANT!

- When grinding/polishing the internal weld, the valve seat must not be touched.

## 11.1 Welding method

The welding result will be best if the following method is used:

A collar is made on the pipe section so that the valve has a flat contact face. This flaring must look like a T-piece, as shown in the example below.

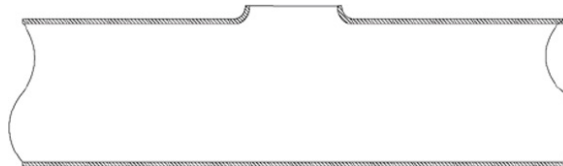

- The pipe section and the valve's hose pieces are sealed with sponge rubber or similar.
- Purge gas such as Argon or Formier gas is fed through the valve body into the pipe section and the system is now filled with 6 times the estimated volume of the pipe section. All  $O_2$  is thus expelled from the system and welding can commence.
- Welding may take place only with the purge gas continually flowing in the system.
- The gas remains in the system until the item is lukewarm, after which the set-up can be dismantled.

## 11.2 Guideline welding values

M4™ valve welded onto a 2 mm 3" dairy pipe: 50-60 Amp.

It should be noted that Keofitt can supply all P type valves welded onto a pipe section according to customer specifications. Flaring is thus avoided and only a girth weld is required.

## 12. BLOCK DIAGRAMS

### 12.1 Keofitt valve type T (tank)

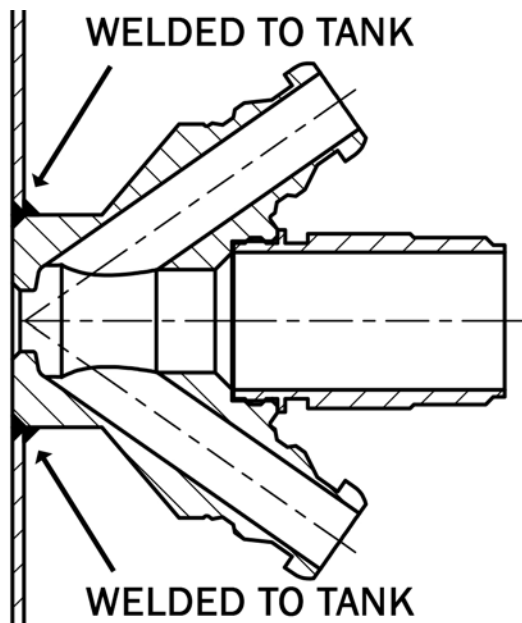

### 12.2 Keofitt valve type P (pipe)

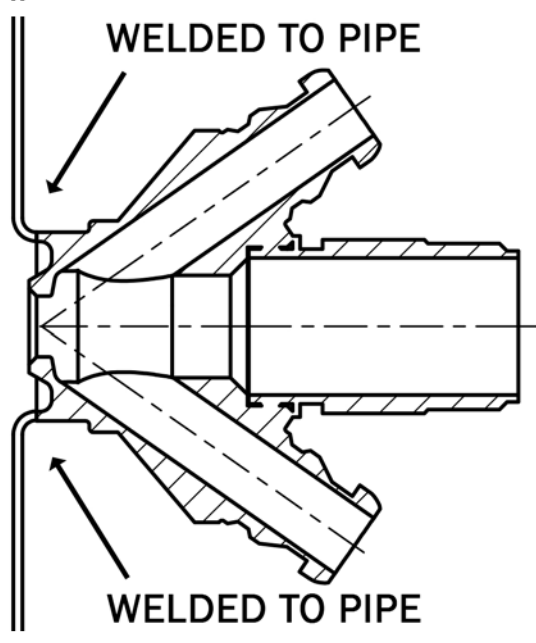

### 12.3 Keofitt valve type P (pipe connection vertical) Inline

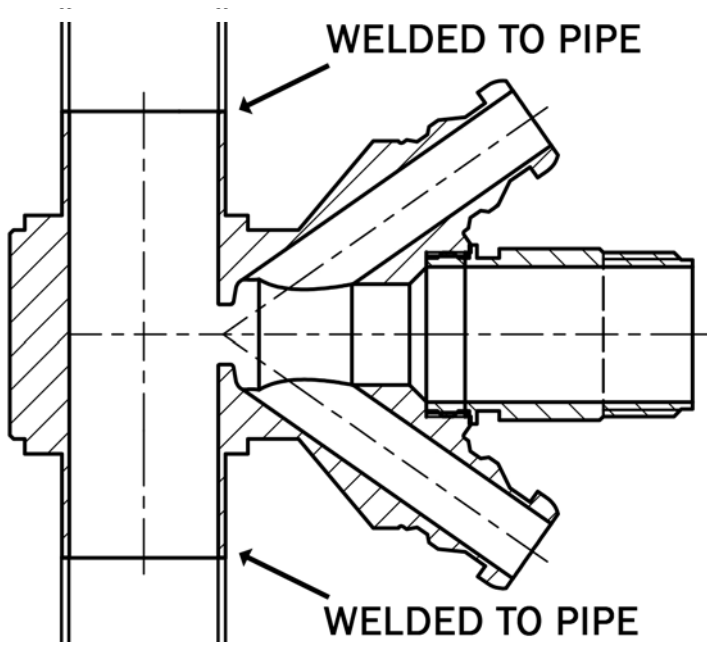

### 12.4 Keofitt valve type clamp connection

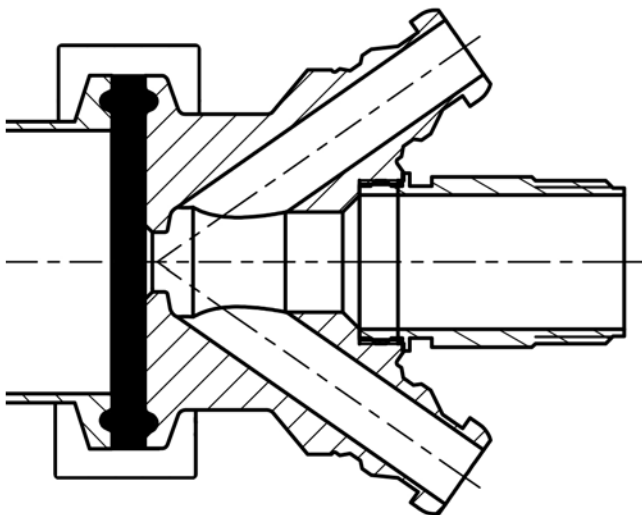

## 12.5 Keofitt valve type Varivent®

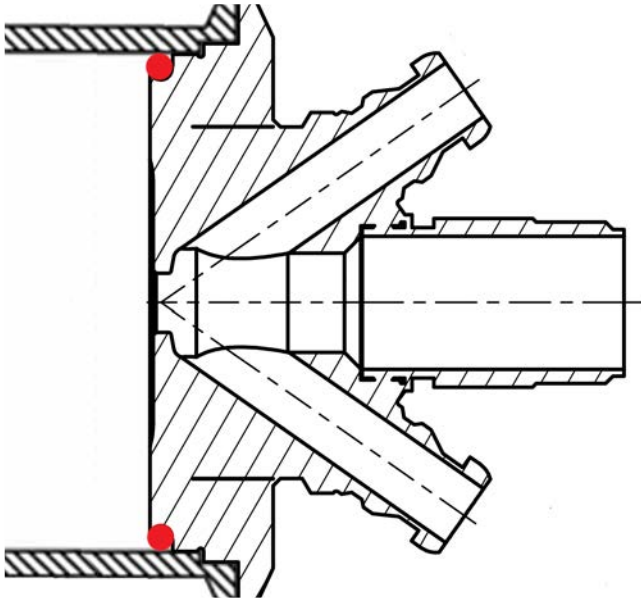

## 12.6 Keofitt valve type thread

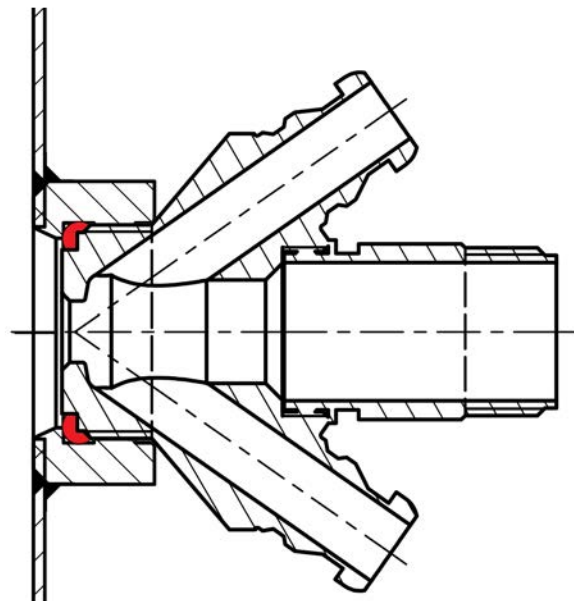

## 13. MAINTENANCE

The rubber membrane should be replaced every other month. PTFE membranes should be replaced every 12 months. In the event of intensive sterilisation and cleaning it may be necessary to replace it more frequently. The appropriate replacement frequency should be determined by the user by starting with short intervals and continuously extend the time in use until one reaches the limit of the membrane's durability. Based on the desired safety margin the user then decides on the replacement interval to adapt.

The rubber plug must be replaced at least once every six months. In each individual case a standard operating procedure including maintenance intervals should be endorsed based on experience. For disassembly of valve body and valve head, see instructions.

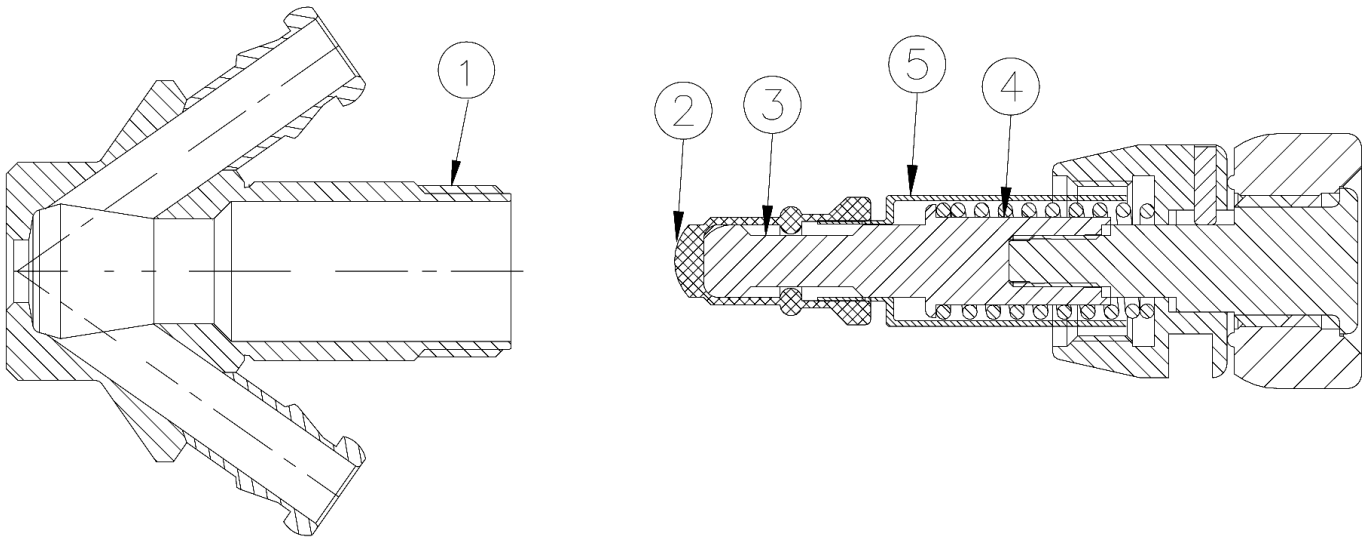

### 13.1 Spare parts list

1. Valve body
2. Membrane Silicone (grey) Membrane EPDM (black) Membrane PTFE (White)
3. Lower stem (slightly different shape for PTFE membrane)
4. Spring (except type B)
5. Steel bushing

## 13.2 Disassembly and assembly of valve body and head

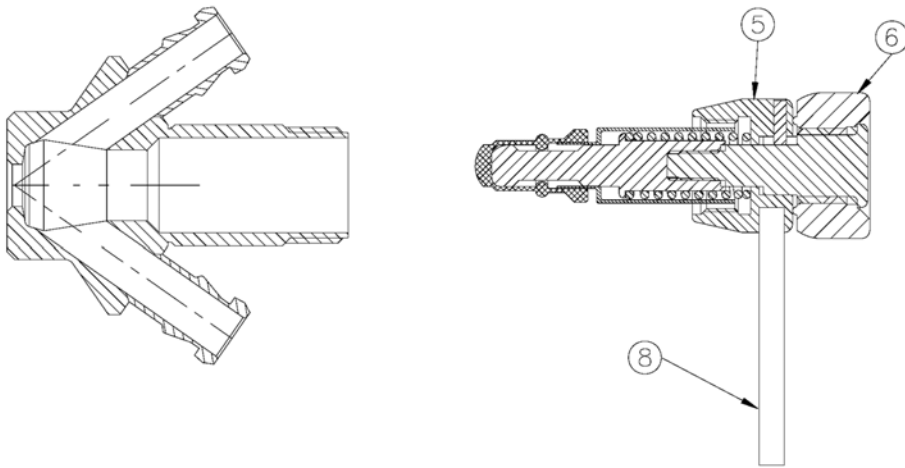

In order to disassemble and assemble the valve body and valve head please perform the following operations:

1. Set the valve head at the OPEN position. For types H and K this is done by turning pos. 6 clockwise.
2. Remove the valve head pos. 5. DON'T use a wrench. A tommy bar pos. 8 should be used for disassembly and assembly. This is carried out by turning pos. 5 anti-clockwise until loose and then pulling the valve head off.
3. Refit the valve head (in the OPEN position) once the necessary parts have been replaced. Care should be taken not to damage the threads. Use suitable lubricant.



### **WARNING!**

- When replacing the membrane, set the valve head in the OPEN position before it is unscrewed and pulled out of the valve body. Omitting to do so may result in twisting and cutting of the membrane.
- Don't clean the valve head in an ultrasonic bath or by immersing it in a degreasing liquid, as it will impede the proper functioning of the screw action. When in doubt, contact your local Keofitt dealer

## 13.3 Disassembly of valve head

Over time the turn knob may become harder to turn, which may be remedied by regreasing the threaded part of the turn knob. Perform the following steps to take the valve head apart after having separated it for the valve body as explained in chapter 13.2:

- Set the valve head in closed position
- Pull off the membrane
- Remove the bushing
- Fix the lower stem in a vice using soft jaws
- Unscrew the valve head top using the tommy bar (hold it back when it gets loose, as the spring will push it out)
- Pull by the knob to separate it from the union nut
- Unscrew the upper stem from the turn knob
- Lubricate the upper stem's threaded part in contact with the turn knob

Assembly is the same in reverse order, but please note:

- Discard the membrane and replace with a new one
- Push the membrane and the bushing together so that the membrane is situated against the shoulder of the bushing



## 14. INSTRUCTIONS ON REPLACING PTFE MEMBRANE

To remove an old membrane from the valve head:

1. OPEN the valve (lever position as in illustration A).
2. Unscrew the valve head from the valve body as described in chapter 13.2.
3. CLOSE valve head (illustration A).
4. Push the membrane and bushing apart (illustration B) until the tool for membrane fits under it.
5. Insert tool for membrane, between the membrane and the bushing (illustration B).
6. OPEN valve head (illustration C).
7. Now the membrane is loosened from the valve head and can be replaced.

To attach a new membrane to the valve head:

8. Set the valve head to CLOSED position (lever position as in illustration B).
9. Place the new membrane on valve head.
10. Mount the membrane bushing with the new Teflon membrane by pressing the membrane with your hand until it clicks.
11. Set the valve head in OPEN position.
12. Insert the valve head into the valve body.
13. CLOSE valve head.



### IMPORTANT

- Once the membrane has been removed from the valve head the click system in the membrane might be damaged. Therefore the membrane might be unsafe for further use and it is recommended not to use the membrane again.
- Do not use hammer or other tool that might scratch the surface of the membrane.

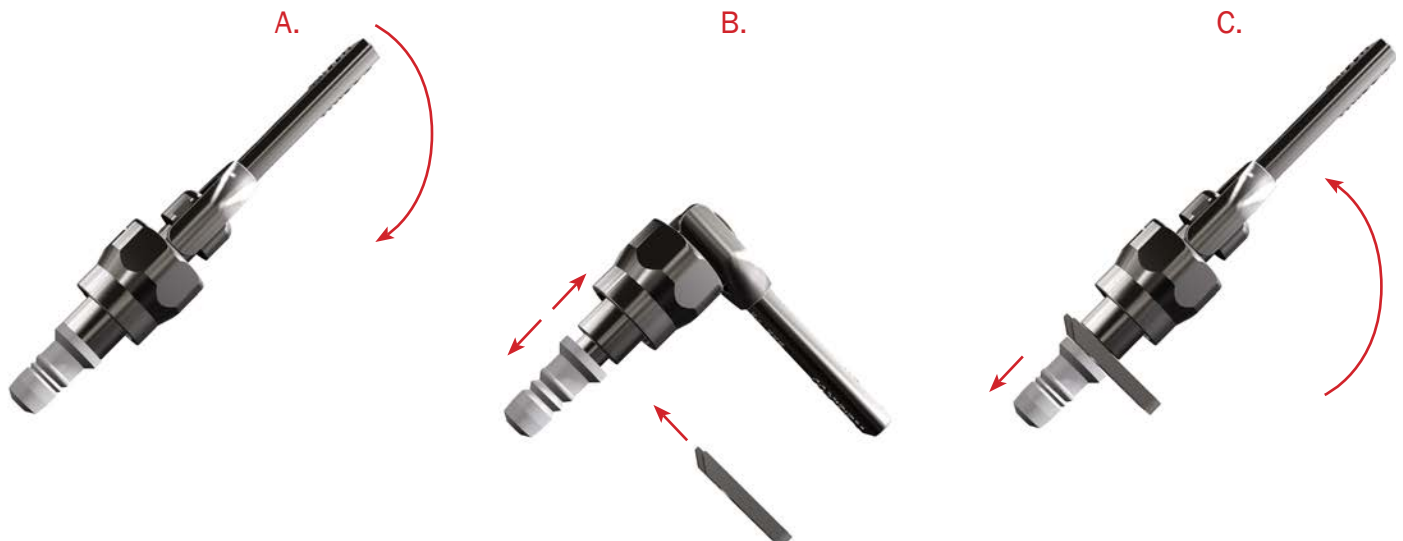

## 15. UPGRADE FROM SILICONE/EPDM TO PTFE MEMBRANE

### 15.1 For manually operated valve heads type H, K and Q



1. Close valve.
2. Pull off the silicone / EPDM membrane.
3. Take the bushing off. (page 30, pos. 5)
4. Put the valve head in vice.
5. Turn the hex-nut counter clockwise until the membrane seat and spring are loose. Put the new lower stem for PTFE membrane in the vice.
6. Fit the spring on the new lower stem.
7. Insert the rest of the valve head in the pin and press firmly.
8. Turn the hex-nut clockwise until the lower stem is firmly in place. Care should be taken not to damage the threads.
9. Put the bushing over the spring, then place PTFE membrane on the lower stem and press firmly until it clicks in place.
10. Put the valve head in open position.
11. Put valve head in valve body and tighten.



#### IMPORTANT

- This is a delicate procedure to be performed by skilled personnel only.
- Use vice with aluminium grips, to avoid scratching and damaging the valve head.
- Do not use hammer or other tool that might scratch the surface of the membrane.

#### Upgrade kit 404155 consisting of:

	<b>Ident no.</b>	<b>Part name</b>	<b>Material</b>
	400340	Lower stem for PTFE	AISI 316L (1.4404)
	400055	Membrane for M4™	PTFE

## 15.2 For manually operated valve heads type B



1. Close valve.
2. Pull off the silicone / EPDM membrane.
3. Take the bushing off. (page 31, pos. 5)
4. Put the valve head in vice.
5. Turn the hex-nut counter clockwise until the membrane seat is loose. Put the new lower stem for PTFE membrane in the vice.
6. Insert the rest of the valve head in the pin and press firmly.
7. Turn the hex-nut clockwise until the lower stem is firmly in place. Care should be taken not to damage the threads.
8. Put the bushing over the lower stem, then place PTFE membrane and press firmly until it clicks in place.
9. Put the valve head in open position.
10. Put valve head in valve body and tighten.



### IMPORTANT

- This is a delicate procedure to be performed by skilled personnel only.
- Use vice with aluminium grips, to avoid scratching and damaging the valve head.
- Do not use hammer or other tool that might scratch the surface of the membrane.

### Upgrade kit 404755 consisting of:

	Ident no.	Part name	Material
	400347	Lower stem for PTFE	AISI 316L (1.4404)
	400055	Membrane for M4™	PTFE

## 15.3 For pneumatically operated valve heads type N

1. Put the actuator in open position. Dismount the actuator by turning it anti-clockwise and pull it out. Pull off the silicone / EPDM membrane and the membrane bushing holding it. Dismount Lever/Q-handle.
2. Use a special tool in the two holes on the end cap and turn it anti-clockwise. Be aware of the pressure released from the spring.
3. Pull out all parts. Inspect interior of actuator for loose parts or particles.
4. Install new valve stem for Teflon. Before mounting, make sure to grease the seal on the entire surface (only use mineral grease).
5. While mounting the valve stem turn it while pushing it down to avoid damaging the seal.
6. Remount the spring.
7. Remount the end-cap by pushing it down turning it clockwise. Tighten it by use of the special tool. Care should be taken not to damage the threads.
8. Mount the air-connection.



9. Mount the bushing with the new teflon membrane installed by pressing the membrane with your hand until it clicks in place.
10. Remount the lever/Q-handle on the actuator and put it in open position. Remount the actuator on the valve body pushing while turning clockwise. Dismount lever/Q-handle. Tighten actuator by use of the tommy-ttt.
11. Re-connect the air hose to air fitting on actuator.



**IMPORTANT**

- Do not use a hammer or any other hard material to mount the membrane. This can damage the membrane seal.

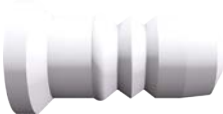
**Upgrade kit 404455 consisting of:**

	<b>Ident no.</b>	<b>Part name</b>	<b>Material</b>
	400348	Stem for M4™	AISI 316L (1.4404)
	400055	Membrane for M4™	PTFE
	600825	O-ring 7,1x1,6	Silicone
	400820	O-ring 15,6x2,4	EPDM

# 16. MEMBRANES

## 16.1 Silicone membrane - art. no. 400051



### 10 PACK MEMBRANE M4 SILICONE, GREY

ART. NO. 400051

#### GENERAL



KEOFITT has the widest selection of spare parts and accessories to complete your sampling system



Compatible with all KEOFIT M4 valve heads for silicone & EPDM membrane



The patented membrane design is an essential part of the hygienic design of the KEOFIT sampling valves



It allows for optimal exposure to CIP and SIP media while also integrating the capacity to remove the membrane from the valve body without the use of tools



#### FEATURES



Compatible with all KEOFIT M4 valve heads for silicone & EPDM membrane

#### CERTIFICATION\*

FDA · USP · EU 1935/2004

#### TECHNICAL DATA

Type:	Silicone (QBF-65 - grey)
Hardness (°Sha):	70 ±3
Tensile strength (MPa):	Min. 8,5
Elongation at break (%):	550 ±80
Density (g/cm3):	1,19 ±0,01
Range of temperature in dry atmospheric air (°C/°F):	-60° - +200°C / -140° - +392°
Compression set, DIN 53517, 24h/175°C (%):	Max. 25
Wear resistance:	Less suitable
Tear resistance:	Very good
Resistance to Weather and Ozone:	Excellent
Resistance to Hydrolysis (water and steam):	Good
Resistance to Chemicals (acids/bases):	Suitable
Resistance to mineral oil and gas:	Less suitable
Air and gas density:	Not suitable

#### SERVICE LIFE

Average service life of a Silicone membrane is 2-3 months - actual life expectancy must be experimentally determined by the user.

Temp. max.:	121°C / 250°F
Steam pressure:	0 - 2 bar (g) / 0 - 29 psi (g)
Process pressure:	0 - 6 bar (g) / 0 - 87 psi (g)
CIP:	NaOH or similar
Samplex:	1-5 a day

#### Net Weight

· Kg/lbs 0,010 kg /0,02 lbs

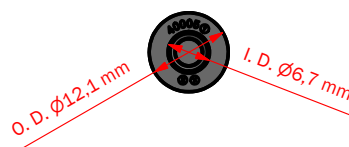
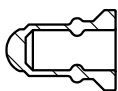

\*For further information please visit keofitt.dk

Last updated 19-12-2014

# 16.2 EPDM membrane - art. no. 400052



## 10 PACK MEMBRANE M4 EPDM, BLACK

ART. NO. 400052

### GENERAL



KEOFITT has the widest selection of spare parts and accessories to complete your sampling system



Compatible with all KEOFIT M4 valve heads for silicone & EPDM membrane



The patented membrane design is an essential part of the hygienic design of the KEOFIT sampling valves



It allows for optimal exposure to CIP and SIP media while also integrating the capacity to remove the membrane from the valve body without the use of tools



### FEATURES



Compatible with all KEOFIT M4 valve heads for silicone & EPDM membrane

### CERTIFICATION\*

FDA · USP · EU 1935/2004

### TECHNICAL DATA

Type:	EPDM (EPL-60 - black)
Hardness (°Sha):	61 ±3
Tensile strength (MPa):	Min. 16
Elongation at break (%):	400 ±50
Density (g/cm3):	1,12 ±0,01
Range of temperature in dry atmospheric air (°C/°F):	-40° - +140°C / -40° - +284° F
Compression set, DIN 53517, 24h/175°C (%):	Min. 16
Wear resistance:	Very good
Tear resistance:	Very good
Resistance to Weather and Ozone:	Excellent
Resistance to Hydrolysis (water and steam):	Excellent
Resistance to Chemicals (acids/bases):	Very good
Resistance to mineral oil and gas:	Not suitable
Air and gas density:	Less suitable

### SERVICE LIFE

Average service life of an EPDM membrane is 2-3 months - actual life expectancy must be experimentally determined by the user.

Temp. max.:	121°C / 250°F
Steam pressure:	0 - 2 bar (g) / 0 - 29 psi (g)
Process pressure:	0 - 6 bar (g) / 0 - 87 psi (g)
CIP:	NaOH or similar
Samplex:	1-5 a day

### Net Weight

· Kg/lbs 0,010 kg /0,02 lbs

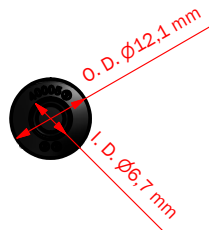
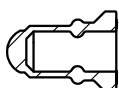

\*For further information please visit keofitt.dk

Last updated 18-12-2014

# 16.3 PTFE membrane - art. no. 400055



## MEMBRANE M4, PTFE

ART. NO. 400055

### GENERAL



KEOFITT has the widest selection of spare parts and accessories to complete your sampling system



Compatible with all KEOFITT M4 valve heads for PTFE membrane



The patented membrane design is an essential part of the hygienic design of the KEOFITT sampling valves



It allows for optimal exposure to CIP and SIP media while also integrating the capacity to remove the membrane from the valve body without the use of tools

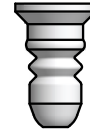

### FEATURES



Compatible with all KEOFITT M4 valve heads for PTFE membrane

### CERTIFICATION\*

FDA - USP - EU 1935/2004

### TECHNICAL DATA

Material:	PTFE (TFM 1600 - white)
Range of temperature in dry atmospheric air:	-200° - +200° C / -328° - +392°
Ball hardness (N/mm <sup>2</sup> ):	29
Tensile strength (DIN53455 - N/mm <sup>2</sup> ):	35
Elongation at break (DIN53455 - %):	350
Density (DIN 53479 - g/cm <sup>3</sup> ):	2,17
Shore D (DIN 53505):	57
Thermal conductivity (W/m.k DIN 52612):	0,22
Expansion coefficient (DIN 53752 [K <sup>-1</sup> ]):	12-17x10 <sup>-5</sup>
Flammability:	Inflammable UL 94
Chemical resistance:	Is not attacked by common chemicals with the exception of strongly oxidising acids

### SERVICE LIFE

Average service life of a PTFE membrane is 12 months - actual life expectancy must be experimentally determined by the user.

Temp. max.:	1 - 150° C / 34 - 302° F
Steam pressure:	0 - 2 bar (g) / 0 - 29 psi (g)
Process pressure:	0 - 6 bar (g) / 0 - 87 psi (g)
CIP:	NaOH or similar

### Net Weight

· Kg/lbs 0,001 kg /0,00 lbs

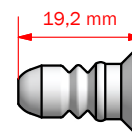
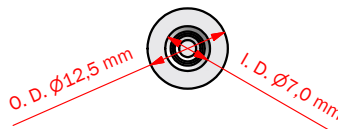
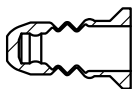

\*For further information please visit keofitt.dk

Last updated 18-12-2014

Keofitt reserves the right to change technical data without notice!

For complete set of updated data sheets and manuals for Keofitt products please refer to our web page [www.keofitt.dk](http://www.keofitt.dk)



KEOFITT A/S  
Kullinggade 31  
DK-5700 Svendborg  
Denmark

Phone +45 6316 7080  
Fax +45 6316 7081

[info@keofitt.dk](mailto:info@keofitt.dk)  
[www.keofitt.dk](http://www.keofitt.dk)

