

Honeywell

RTH5100B Non-programmable Thermostat

INSTALLATION INSTRUCTIONS

The RTH5100B Thermostat provides electronic control of 24 Vac single-stage heating and cooling systems or 750 mV heating systems.



START HERE

For assistance with your Honeywell product, please visit www.honeywell.com/yourhome or call Honeywell Customer Care toll free at 1-800-468-1502.

Read and Save these Instructions

® U.S. Registered Trademark
© 2004 Honeywell International Inc.
All Rights Reserved • Patents Pending



69-1716

Contents

Prepare for Installation.....	3
Follow Important Instructions.....	5
Remove Old Thermostat.....	6
Follow Special Instructions	7
Label Old Thermostat Wires	10
Mount New Wallplate to Wall	11
Connect Wires to New Wallplate	15
Install Batteries	20
Attach New Thermostat to Wallplate.....	21
Configure Installer Setup	22
Customer Assistance	28
Limited One-Year Warranty	29

Step 1. Prepare for Installation

1. Check that the following items are included:

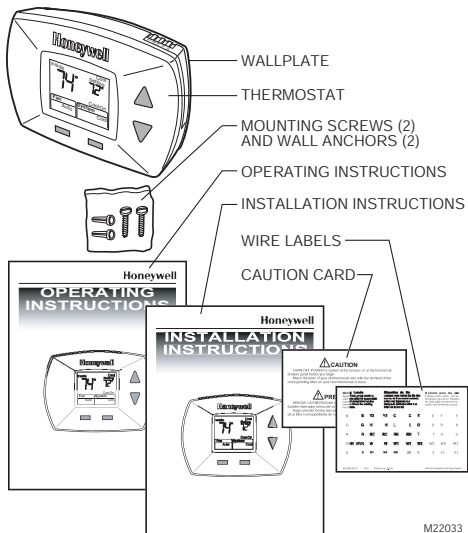

If any of the items shown above are missing, call Honeywell Customer Care at 1-800-468-1502 before returning the thermostat to the store.

Step 1. Prepare for Installation (Cont)

2. Check that you have everything required for the installation:
 - Two AAA alkaline batteries
 - No. 2 Phillips screwdriver and standard pocket screwdriver
 - Drill
 - Drill bit— use 3/16 in. for drywall; use 7/32 in. for plaster
 - Level (optional)
 - Hammer
 - Pencil
 - Electrical tape

Step 2. Follow Important Instructions

1. Do not connect the wires to the new thermostat based on wire color because damage can occur to the heating and/or cooling system.

These Installation Instructions explain later how to use the enclosed wire labels to correctly mark the wires connected to your old thermostat.

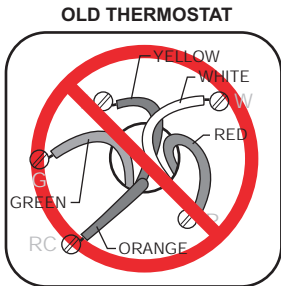



**DO NOT WIRE
NEW THERMOSTAT
BASED ON
WIRE COLOR.**

M22034

Step 3. Remove Old Thermostat

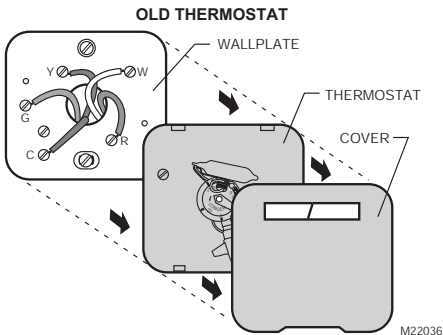
1. Turn off power at the heating and/or cooling system or fuse/circuit breaker panel.
2. Remove the cover from the old thermostat.
3. Remove the old thermostat from the wall or wallplate. **Do not remove the wires.**



MERCURY NOTICE

If you are replacing a thermostat that contains mercury in a sealed tube, do not place your old thermostat in the trash.

Contact your local waste management authority for instructions regarding recycling and the proper disposal of an old thermostat containing mercury in a sealed tube.

Step 4. Follow Special Instructions

1. If you have C and/or C1 wire(s) connected to your old thermostat, do not connect them to your new thermostat.
2. Disconnect the C and/or C1 wire(s). Make sure they do not touch each other or any other wires.
3. Wrap the bare end of each C and/or C1 wire(s) with electrical tape.

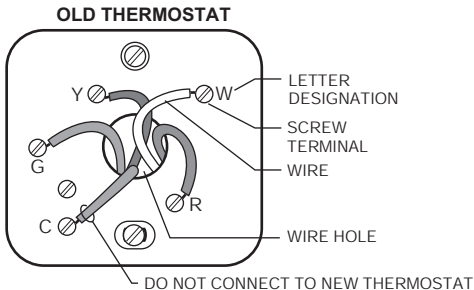

M22037

Step 4. Follow Special Instructions (Cont)

4. Most installations have two to five wires connected to the old thermostat. If six or more wires are connected to your old thermostat (not counting the C or C1 wires), *do not continue the installation*. You may have purchased the wrong thermostat.

Visit www.honeywell.com/yourhome or call Honeywell Customer Care at 1-800-468-1502 before returning the thermostat to the store.

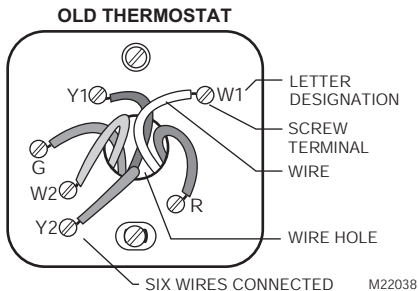

Step 4. Follow Special Instructions (Cont)

5. If you find any wires not connected to your old thermostat, do not connect them to your new thermostat.
6. Wrap the end of the wires that are not connected with electrical tape.

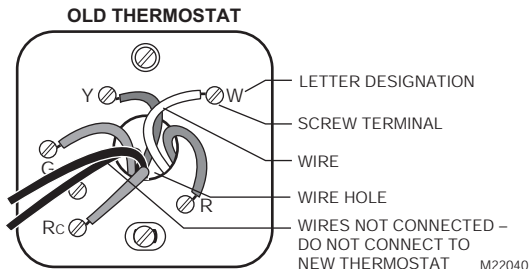

Step 5. Label Old Thermostat Wires

1. As you disconnect each wire, use the enclosed wire labels to wrap a wire label around each wire that matches the letter designation. Do not allow the wires to fall into the wall opening after the wires are disconnected.
2. Remove any remaining parts of the old thermostat from the wall.

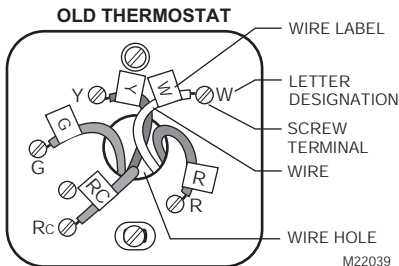

When connecting the wires to the new thermostat, refer to the wire labels. Do not connect wires to your new thermostat based on the color of the wire.

Step 6. Mount New Wallplate to Wall

1. Separate the wallplate from the thermostat as shown.

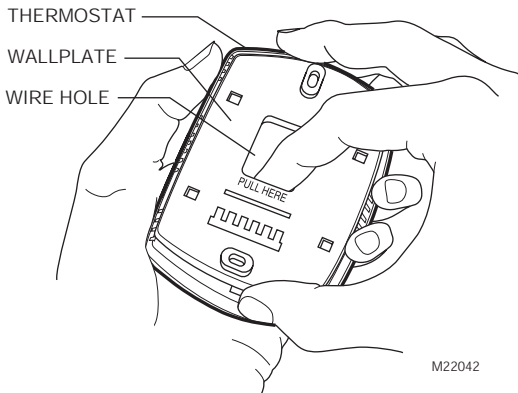

Step 6. Mount New Wallplate to Wall (Cont)

2. Pass the labeled wires through the wire hole on the wallplate.

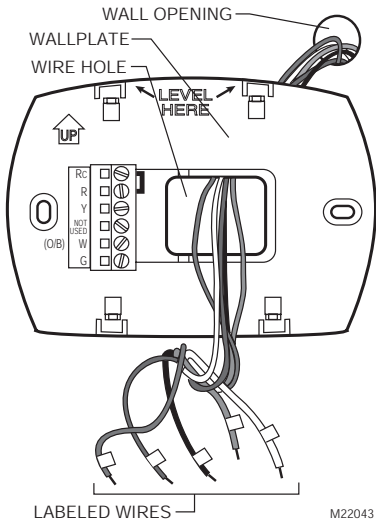

M22043

Step 6. Mount New Wallplate to Wall (Cont)

3. Position the wallplate on the wall with the arrow pointing up. Level the wallplate (for appearance only) and mark the two mounting holes with a pencil.

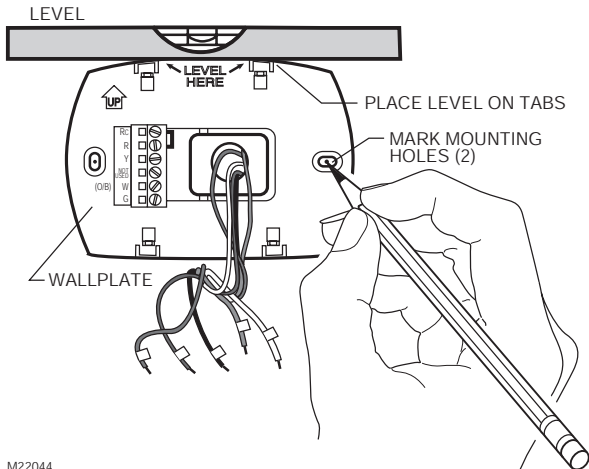

M22044

Step 6. Mount New Wallplate to Wall (Cont)

4. Move the wallplate aside and drill holes at the locations marked on the wall. Drill 3/16 in. holes for drywall or 7/32 in. holes for plaster.
5. Tap the wall anchors into the drilled holes until even with the wall surface.

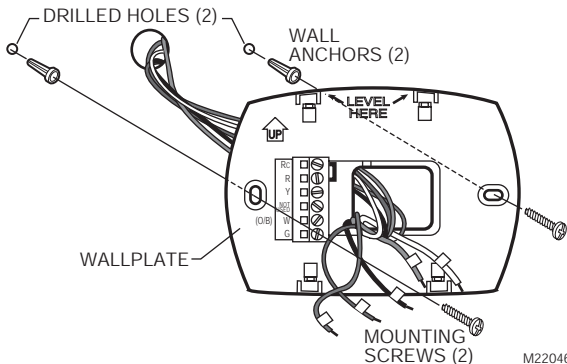

6. Position the wallplate over the wall anchors.
7. Insert the mounting screws into the wall anchors. Check leveling, if desired, and tighten the mounting screws.

Step 7. Connect Wires to New Wallplate

1. Match the labeled wires to the letter designations on the wallplate.
2. If wires are to be connected to both Rc and R, loosen the Rc and R screw terminals and remove the metal jumper.
3. If only one of the terminals, Rc or R, is to be connected, leave metal jumper in place.

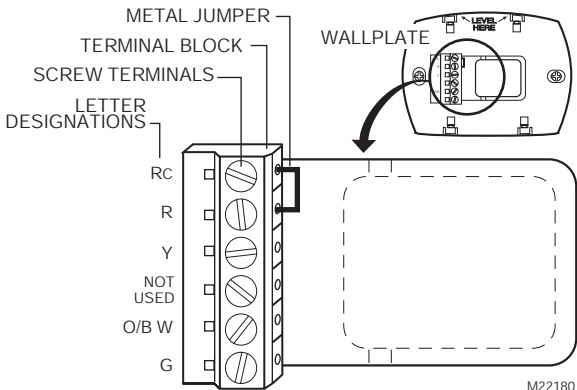

Step 7. Connect Wires to New Wallplate (Cont)

- Loosen the screw terminals. Insert the labeled wires into the holes on the right side of the terminal block that match the letter designations. Tighten the screw terminals.
- If any of the labeled wires do not match the letter designations, see next page for wire connections.

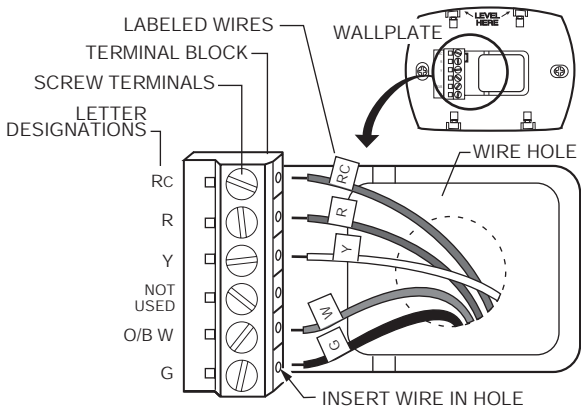

M22176

Step 7. Connect Wires to New Wallplate (Cont)



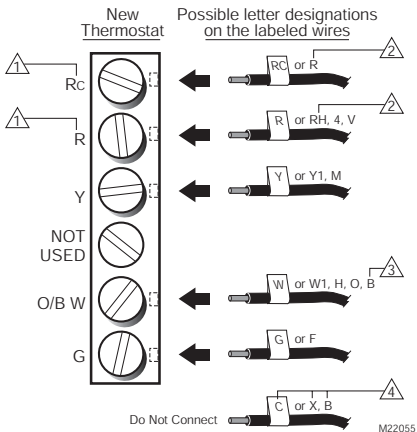

6. Compare letter designations on your old and new thermostats.



Do not connect more than one wire to each terminal. Be sure to read the notes referenced in the numbered triangles above. These numbered notes appear on the next page.

Step 7. Connect Wires to New Wallplate (Cont)

NOTES

-  If wires will be connected to both Rc and R on the new thermostat, remove metal jumper between Rc and R. Leave metal jumper in place if only one of the terminals, Rc or R, will be connected on the new thermostat.
-  If wires were connected to both R and RH terminals on the old thermostat, remove metal jumper between Rc and R on the new thermostat. Connect the old R to the new Rc and the old RH to the new R.
-  Do not connect both O and B when wiring to a heat pump. Connect O to O/B W. Wrap the bare end of the B wire with electrical tape and do not use.
-  Transformer common. Wrap the bare end of the wire with electrical tape and do not use.

M22050

Step 7. Connect Wires to New Wallplate (Cont)

7. Push excess wire back into the wall opening. Keep wires in the shaded area.

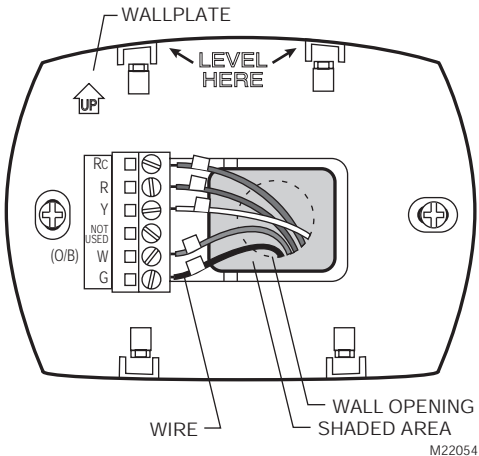

Step 8. Install Batteries

1. Install two fresh AAA alkaline batteries on the back of the thermostat as marked on the battery holder.

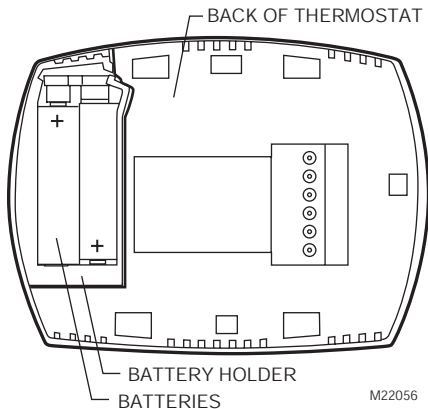

After the thermostat is mounted on the wallplate, the thermostat does not require removal from the wallplate to replace the batteries. Refer to the enclosed Operating Instructions (69-1722) for more information on the removable battery holder.

Step 9. Attach New Thermostat to Wallplate

1. Align the four tabs on the wallplate with the four slots on the back of the thermostat.

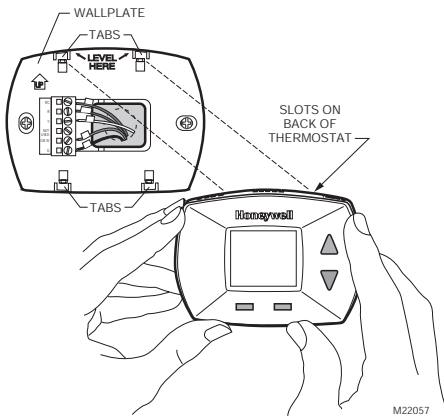

2. Push the thermostat straight onto the wallplate until it snaps into place.
3. Turn on the power at the heating and/or cooling system or fuse/circuit breaker panel.



Tip If the wires interfere with mounting the thermostat to the wallplate, push the excess wire back into the wall opening.

Step 10. Configure Installer Setup

1. Use the Installer Setup Menu to match your new thermostat to your heating and/or cooling system. Follow the steps in this section to set up your thermostat.
2. Enter the Installer Setup Menu by pressing and holding the Up and Fan buttons at the same time, for approximately five seconds, until the screen changes.

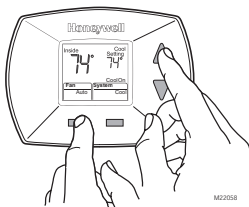

3. Release the buttons when the display on your thermostat matches the display below.

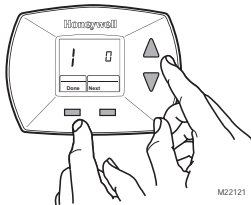

10. Configure Installer Setup (Cont)

- Press the Up or Down button to select your setting for Installer Setup Number 1 in the table below.
- After you select your setting, press the Next button to go to the next Installer Setup Number.

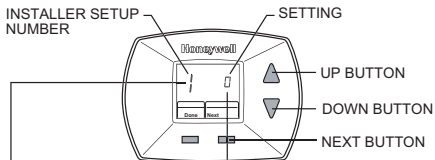

Installer Setup Number	Installer Setup Name	(Select Your Setting) Settings
1	Heating and/or Cooling System Type	<p>0—Heating and Cooling—Gas, oil or electric heating with central air conditioning.</p> <p>1—Heat Pump—The compressor outside runs in both heating and cooling.</p> <p>2—Heating Only—Gas, oil or electric heating without central air conditioning.</p> <p>3—Heating Only with Fan—Gas, oil or electric heating without central air conditioning. (Use this setting if you could turn the fan on and off with a fan switch on your old thermostat.)</p>

M22122

Configure Installer Setup (Cont)

- If you do not have a number **2** on the left side of your display, go to the next page.
- If you have a number **2** on the left side of your display, press the Up or Down button to select your setting for Installer Setup Number 2 in table below.
- After you select your setting, press the Next button to go to the next Installer Setup Number.

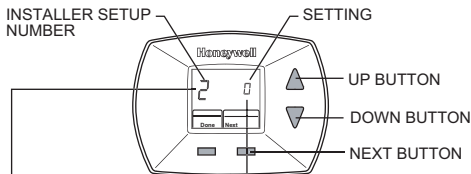

Installer Setup Number	Installer Setup Name	(Select Your Setting) Settings
2	Heat Pump Change-over Valve	0—Changeover Valve in Cooling— Use this setting if you connected a wire labeled O to O/B W terminal. 1—Changeover Valve in Heating— Use this setting if you connected a wire labeled B to O/B W terminal.

M22060

Step 10. Configure Installer Setup (Cont)

- If you do not have a number **3** on the left side of your display, go to the next page.
- If you have a number **3** on the left side of your display, press the Up or Down button to select your setting for Installer Setup Number 3 in table below.
- After you select your setting, press the Next button to go to the next Installer Setup Number.

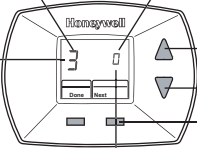

The diagram shows a Honeywell thermostat control panel. Labels point to various components: 'INSTALLER SETUP NUMBER' points to the number '3' on the left; 'SETTING' points to the number '0' in the center; 'UP BUTTON' and 'DOWN BUTTON' are the triangular buttons on the right; and 'NEXT BUTTON' points to the bottom-most button.

Installer Setup Number	Installer Setup Name	(Select Your Setting) Settings
3	Fan Control in Heating	0—Gas or oil Heat —Heating system controls fan in a call for heat. 1—Electric Heat —Thermostat controls fan in a call for heat.

M22061

Step 10. Configure Installer Setup (Cont)

12. If you do not have a number **5** on the left side of your display, go to the next page.
13. If you have a number **5** on the left side of your display, press the Up or Down button to select your setting for Installer Setup Number 5 in table below.
14. After you select your setting, press the Next button to go to the next Installer Setup Number.

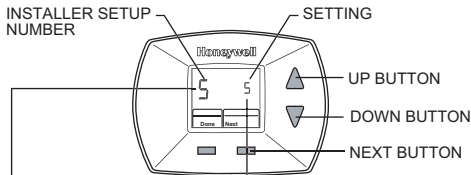

Installer Setup Number	Installer Setup Name	(Select Your Setting) Settings
5	Heating Cycle Rate	5—Gas or Oil Furnace (less than 90% efficient) 9—Electric Furnace 3—Gas or Oil Hot Water, Gas 90 %+ High-Efficiency Furnace 1—Gas or Oil Steam, Gas or Oil Gravity

M22062

Step 10. Configure Installer Setup (Cont)

- Press the Up or Down button to select your setting for Installer Setup Number 14 in table below.
- After you select your setting, press the Done button to exit the Installer Setup and save your settings.
- Congratulations! The installation of the thermostat is complete. Refer to the enclosed Operating Instructions (69-1722) for information on how to operate your new thermostat.

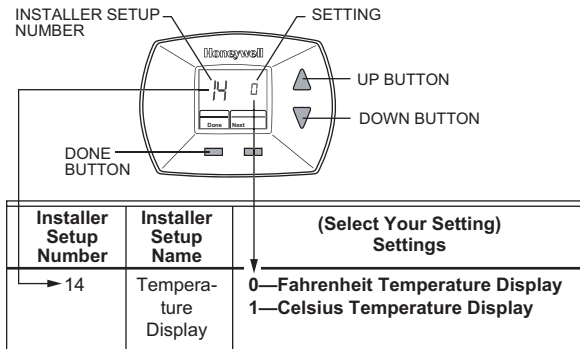

M22063

Customer Assistance

For assistance with your Honeywell product please visit www.honeywell.com/yourhome or call Honeywell Customer Care toll free at 1-800-468-1502.

Before calling, please have the thermostat model number and date code available.

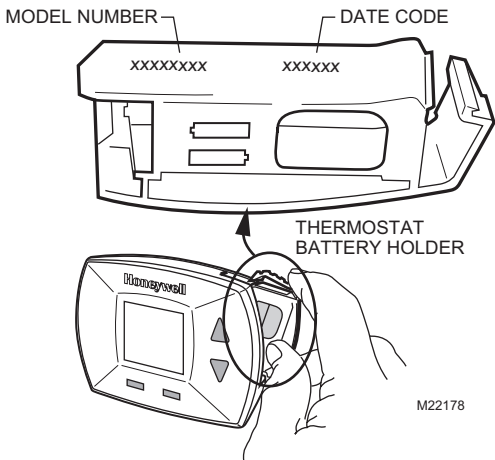

Limited One-Year Warranty

Honeywell warrants this product, excluding battery, to be free from defects in the workmanship or materials, under normal use and service, for a period of one (1) year from the date of purchase by the consumer. If, at any time during the warranty period, the product is defective or malfunctions, Honeywell shall repair or replace it (at Honeywell's option) within a reasonable period of time.

If the product is defective,

- (i) return it, with a bill of sale or other dated proof of purchase, to the retailer from which you purchased it, or
- (ii) package it carefully, along with proof of purchase (including date of purchase) and a short description of the malfunction, and mail it, postage prepaid, to the following address:

Honeywell Return Goods
Dock 4 MN10-3860
1885 Douglas Dr N
Golden Valley, MN 55422

This warranty does not cover removal or reinstallation costs. This warranty shall not apply if it is shown by Honeywell that the defect or malfunction was caused by damage which occurred while the product was in the possession of a consumer.

Honeywell's sole responsibility shall be to repair or replace the product within the terms stated above. HONEYWELL SHALL NOT BE LIABLE FOR ANY LOSS OR DAMAGE OF ANY KIND, INCLUDING ANY INCIDENTAL OR CONSEQUENTIAL DAMAGES RESULTING, DIRECTLY OR INDIRECTLY, FROM ANY BREACH OF ANY WARRANTY, EXPRESS OR IMPLIED, OR ANY OTHER FAILURE OF THIS PRODUCT. Some states do not allow the exclusion or limitation of incidental or consequential damages, so this limitation may not apply to you.

Limited One-Year Warranty (Cont)

THIS WARRANTY IS THE ONLY EXPRESS WARRANTY HONEYWELL MAKES ON THIS PRODUCT. THE DURATION OF ANY IMPLIED WARRANTIES, INCLUDING THE WARRANTIES OF MERCHANTABILITY AND FITNESS FOR A PARTICULAR PURPOSE, IS HEREBY LIMITED TO THE ONE-YEAR DURATION OF THIS WARRANTY. Some states do not allow limitations on how long an implied warranty lasts, so the above limitation may not apply to you.

This warranty gives you specific legal rights, and you may have other rights which vary from state to state.

If you have any questions concerning this warranty, please write Honeywell Customer Relations, 1985 Douglas Dr, Golden Valley, MN 55422 or call 1-800-468-1502. In Canada, write Retail Products ON15-02H, Honeywell Limited/Honeywell Limitée, 35 Dynamic Drive, Scarborough, Ontario M1V4Z9.





Honeywell

Automation and Control Solutions

Honeywell International Inc.
1985 Douglas Drive North
Golden Valley, MN 55422

Honeywell Limited-Honeywell Limitée
35 Dynamic Drive
Scarborough, Ontario
M1V 4Z9



Printed in U.S.A. on recycled
paper containing at least 10%
post-consumer paper fibers.

69-1716 G.H. 5-04

www.honeywell.com/yourhome