



PROFESSIONAL
SECURITY SYSTEM

WIRELESS AUTODIAL HOME ALARM SYSTEM

AM2000



INSTRUCTIONS FOR USE

IMPORTANT! PLEASE READ THESE INSTRUCTIONS CAREFULLY.

IMPORTANT BEFORE RETURNING THIS PRODUCT TO THE RETAILER

PLEASE CONTACT IF YOU HAVE ANY
CONCERNS OR PROBLEMS WITH THIS PRODUCT

Customer Service Phone: (03) 9982 5111 (Monday to Friday 8.30am – 5.30pm EST)

Email: customerservice@orionlive.com.au

For further information visit www.orionlive.com.au

1 IDENTIFICATION

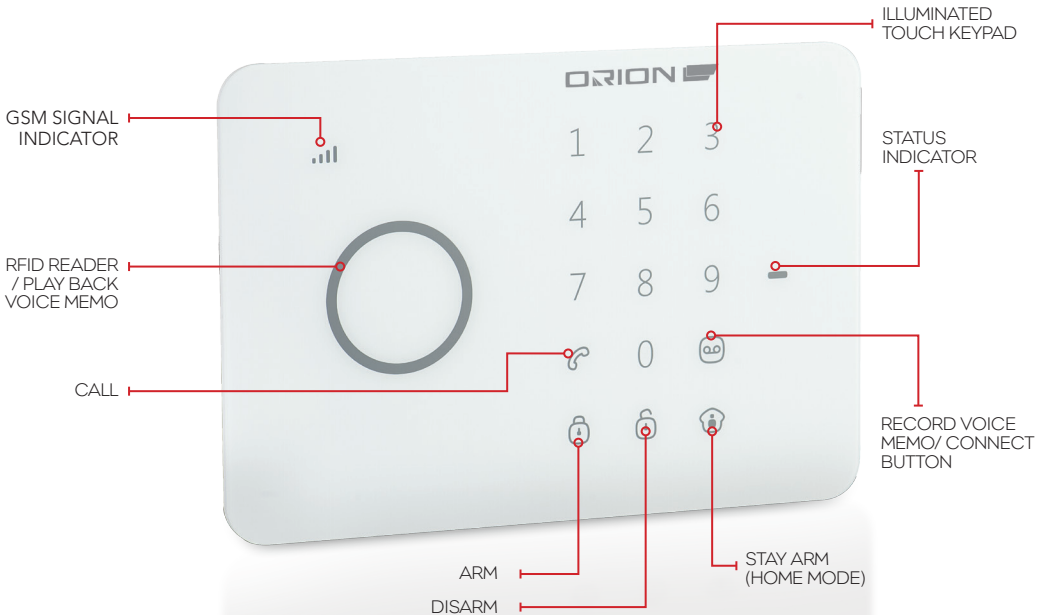

CONTENTS: ALARM PANEL



2 X PIR
MOTION
SENSORS



2 X DOOR/
WINDOW
CONTACT
SENSORS



2 X REMOTE
CONTROLS



2 X RFID TAGS



POWER
SUPPLY



DETERRENT
STICKERS



MOUNTING SCREWS,
PLUGS AND BRACKETS

USER MANUAL

2 ALARM PANEL

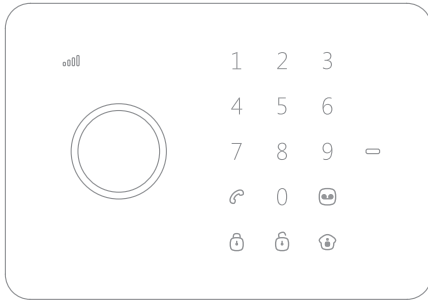

ARM

Press the **Arm Button**  to arm the system.

HOME MODE

Press the **Home Button**  to arm the system in home mode. All the sensors in Normal Zone are armed except those in Home Mode Zone which are disarmed so that user can move freely at home.

DISARM ON KEYPAD

Input 4 digits password (Default:1234), and press the **Disarm Button**  to disarm the system after one beep. If three beeps are heard, password is wrong and please input again.

DISARM BY RFID TAG

Wave the RFID tag near the RFID Reader area to disarm the system.

GSM SIGNAL INDICATOR

GSM Networking searching:
- Flashes once every second.

GSM signal normal:
- Flashes once every 2 seconds.

IMPORTANT

A SIM card is required to access most functions of AM2000 Home Alarm System.

1. Restart the alarm panel after inserting a new SIM card.
2. SIM card not included. Please use a valid SIM card that is compatible to the GSM network with sufficient credit to enable the GSM SMS function of AM2000 Home Alarm System.
3. Please store the AM2000 SIM card number in a safe place and keep as a secret because AM2000 Home Alarm System can be controlled via SMS operation.

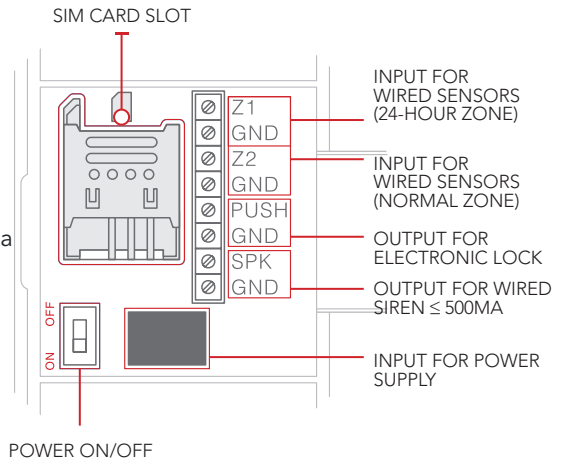
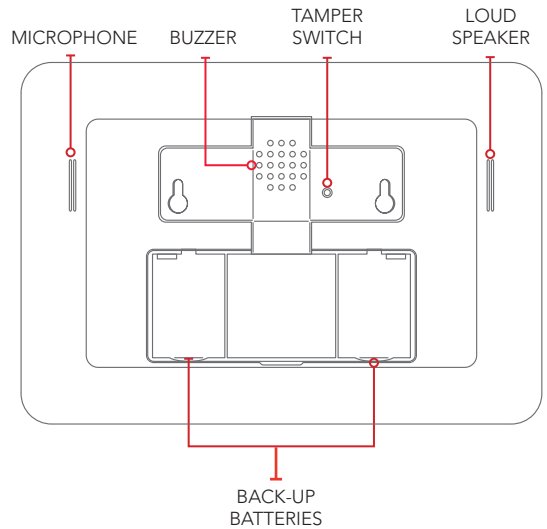

2.1 CONNECT WIRELESS SENSORS, REMOTE CONTROLS & RFID TAGS

1. Enter alarm panel password (Default:1234).
2. Press **Connect Button** and button illuminates.
3. Trigger signal within 15 seconds after pressing **Connect Button** .
 - a. AM2010 PIR Motion Sensor: Press test button twice.
 - b. AM2020 Door/Window Contact Sensor: Break contact by moving magnet away from sensor.
 - c. Remote Control: Press any button on the remote control
 - d. RFID Tag: Wave RFID tag near alarm panel RFID reader.
4. Connection successful when alarm panel beeps once.

NOTE:

- If alarm panel beeps twice, accessory has been added before.
- Alarm panel assigns zones sequentially. The first connected accessory is assigned in Zone 1, the second one in Zone 2 and so on.
- Alarm panel supports up to 10 remote controls, 50 wireless sensors or sirens and 50 RFID tags.

2.2 CONNECT WIRELESS STROBE SIREN

AM2030 Strobe Siren can be added to increase alarm visibility and audibility.

1. Open AM2030 siren front cover.
2. Press and hold tamper switch for the entire pairing setup to avoid false tamper alarm.
3. Connect power supply to AM2030 siren.
4. Disarm AM2000 control panel by keying in password and pressing **Disarm Button** .
5. Press and hold AM2030 siren **Pairing Button** for 0.5 second.
6. Arm AM2000 control panel by pressing **Arm Button** to pair with AM2030 siren.
7. When AM2030 siren beeps once, they are paired successfully.
8. After pairing, disconnect power supply and reassemble front cover.
9. AM2030 siren is ready for use and fixed mounting installation.

When intruder is detected, both AM2000 control panel and AM2030 strobe light siren will hoot to deter the intruder. The siren will turn off in 1 minute on factory default setting.

2.3 RECORD/PLAY VOICE MEMO

Press and hold **Record Button** for 3 seconds to record 10 seconds voice message. Or send SMS to system for calling back to record the voice messages (Refer to section 2.13). The **Play Voice Memo Button** will be flashing in blue to remind you. Users can touch the center of circle to listen to the voice memo. The LED indicator blacks out when the voice is played. Replay by touching it again.

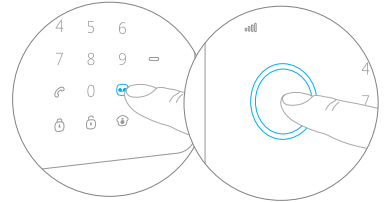

2.4 RFID TAG

The RFID tag is for disarming the system and unlocking the electronic door lock (if connected). You can rename the RFID tags and store a mobile phone number to send SMS notice when family members come home and disarm the system (Refer to section 2.19 and 2.24).

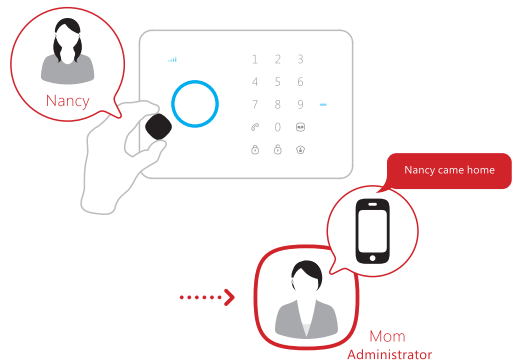



NOTE:

1. Only after SMS No. is stored and the RFID tags SMS notice is changed (4 RFID tags can be renamed), users can receive notice SMS once someone disarms the system by RFID tag.
2. RFID tags only operate when AM2000 alarm panel is powered by power supply.

2.5 SPEED DIAL

Press **Call Button** , the panel auto dials to pre-stored phone number of the host. Press **Call Button** again to end phone call (Refer to section 2.20).

2.6 PHONE CALL

Dial phone number and then press **Call Button**  to make phone call. Press **Call Button**  again to end phone call.

2.7 ELECTRONIC LOCK OUTPUT

When system is disarmed, the output signal opens electronic lock automatically.

2.8 SMS OPERATION

Open back cover, insert SIM card and turn on alarm panel. Wait until alarm panel acquires GSM signal. When the GSM signal indicator flashes every two seconds, network connection is established.

NOTE: Please check credit on the SIM card account periodically to ensure the functionality and reliability of the GSM SMS operates correctly.

Send a text of "???" to the SIM card number, the operation guide message will be replied. You can control the alarm system by following the guide message:

Send:

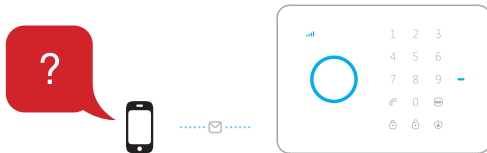

System replies first grade guide menu:

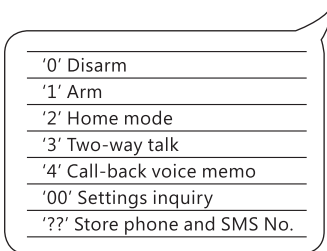

Send:

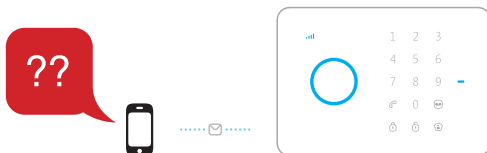

System replies second grade guide menu:

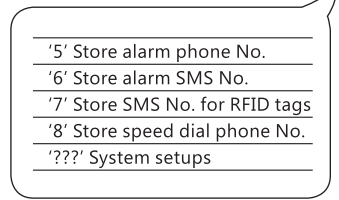

Send:

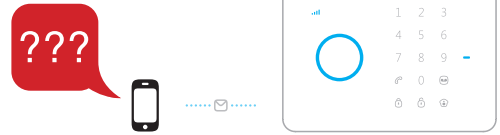

System replies third grade guide menu:

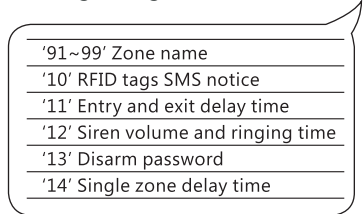

2.9 DISARM

Send:

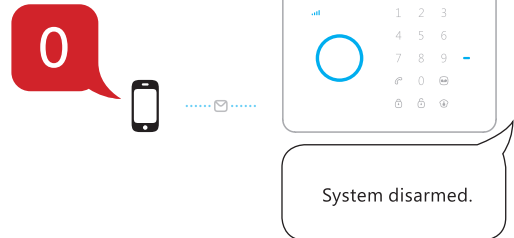

2.10 ARM

Send:

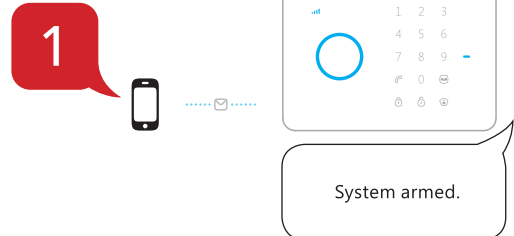

2.11 STAY ARM (HOME MODE)

Send:

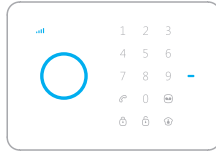

System in home mode.

2.12 TWO-WAY TALK

Send:

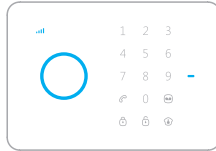

Send '3' to the SIM card number, the alarm will call back. Pick up the phone and start two-way talk.

2.13 CALL-BACK TO RECORD VOICE MEMO

Send:

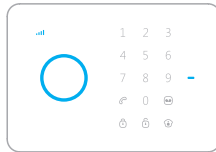

Send '4' to the SIM card number, the alarm will call back. Pick up the phone, and leave 10 seconds message. The panel will hang up after 10 seconds.

2.14 SETTINGS INQUIRY

Send:

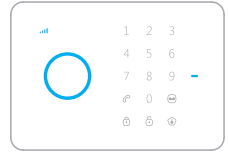

System status
 Entry and exit delay time: 0sec
 Single zone delay time: 30sec
 Siren volume: 2
 Siren ringing time: 5min
 Disarm password: 1234

NOTE:

Value of default setting will be changed once users finish programming.

2.15 STORE ALARM PHONE NO.

Alarm panel makes phone calls to stored phone numbers when alarm is triggered.

Send:

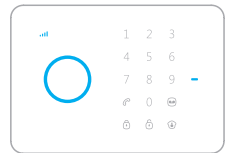

TEL:

1. _____
2. _____
3. _____
4. _____
5. _____

Forward > Edit

- TEL:
1. 67890033
 2. 67890022
 3. 67890011
 4. 67890000
 5. _____

Store alarm phone No. successfully.



2.16 PHONE REMOTE OPERATION

When receiving an alarm call from alarm panel for an emergency, the alarm system can be controlled to perform the appropriate operation.

ACTION	OPERATION
Press 1	Arm alarm system
Press 0	Disarm alarm system
Press 9	Turn on siren to deter intruder
Press 6	Turn off siren
Press *	Two-way talk between phone and alarm panel
Press #	Replay recorded alarm voice message

2.17 RECORD ALARM VOICE MESSAGE

This alarm voice message will be played when user picks up alarm phone call.

1. Enter alarm panel password (Default:1234).
2. Press **Home button** , then press **Record button** .
3. After the  button illuminates, the alarm panel starts recording for 10 seconds.
4. Communicate an alarm message clearly to the alarm panel microphone.
5. If the recording is successful, this voice message will be played upon picking up an alarm call.

2.18 STORE ALARM SMS NO.

Alarm panel sends SMS notifications to stored phone numbers when alarm is triggered.

Send:

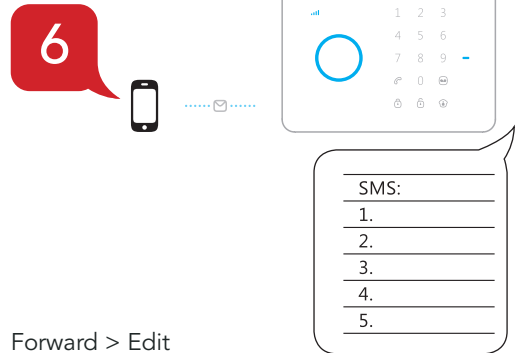

Forward > Edit



2.19 STORE SMS NO. FOR RFID TAGS

Alarm panel sends SMS notification to stored phone number when system is disarmed using RFID tag.

Send:

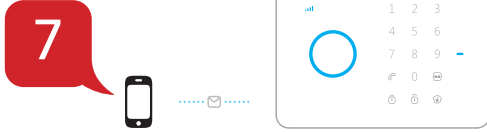

SMS No. for RFID tags
(0-20 digits):
1.

Forward > Edit

SMS No. for RFID tags
(0-20 digits):
1. 67890033

Store SMS No. for RFID tags successfully.

NOTE:

- 1 Only after SMS No. is stored and the RFID tags SMS notice is changed, users can receive notice SMS once someone disarms the system by RFID tag.
2. RFID tags only operate when AM2000 alarm panel is powered by power supply.

2.20 STORE SPEED DIAL PHONE NUMBER

Alarm panel speed dials stored phone number when **Call Button** is pressed.

Send:

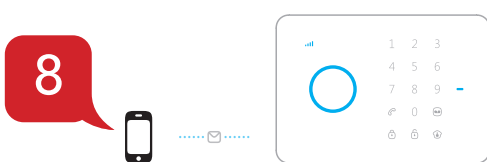

Speed dial phone number
(0-20 digits):
1.

Forward > Edit

Speed dial phone number
(0-20 digits):
1. 67890033

Store speed dial phone number successfully.

2.21 CHANGE ZONE NAME

Users can change the 1st~9th zone names. The zone name should be 30 characters at most for each line due to SMS character limit. Other alarm zones are fixed as Zone 10 alarm, Zone 11 alarm and so on.

Send: Code 91 ~ 99

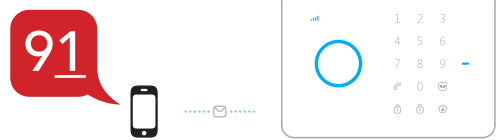

Zone1 name: Zone 1 alarm

Forward > Edit

Zone1 name: Entrance door sensor

Change zone name successfully.

2.22 SMS ALERT FOR LOW BATTERY OF ACCESSORIES

(Available for AM2010 only)

SMS will be sent for 1-9 zones with its zone name as "Zone name + low battery"

Bedroom PIR low battery.

SMS alert for 10~50 zones will be "Zone number + low battery"

Zone 10 low battery.

2.23 SMS ALERT FOR TAMPER ALARM OF ACCESSORIES

(Available for AM2010, AM2020 and AM2030)

SMS will be sent for 1-9 zones with its zone name as "Zone name + tamper alarm"

Bedroom PIR tamper alarm.

SMS alert for 10~50 zones will be "Zone number + tamper alarm"

Zone 10 tamper alarm.

2.24 CHANGE RFID TAGS SMS NOTICE

RFID tags can be associated with users by assigning names to the tags.

Send

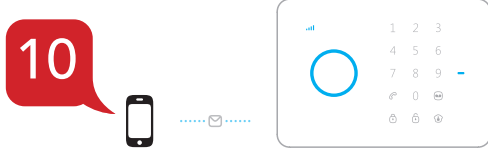

Change RFID tags SMS notice:

1. _____
2. _____
3. _____
4. _____

Forward > Edit

Change RFID tags SMS notice:

1. Tom
2. Nurse
3. Nancy
4. David

Change RFID tags SMS notice successfully.

NOTE:
Only after SMS No. is stored and the RFID tags SMS notice is changed, users can receive notice SMS once someone disarms the system by RFID tag.

2.25 ENTRY AND EXIT DELAY TIME

Delay time is required when arming or disarming without the use of remote control and RFID tag. After pressing **Arm Button** , the alarm panel will change to Armed state after this delay time. This allows the user to exit the premises without triggering the alarm.

Alarm will beep every second to remind user to exit premises. The reminder beep speeds up in the last 15 seconds. If intruder is detected, the alarm is delayed based on this delay time.

Send:

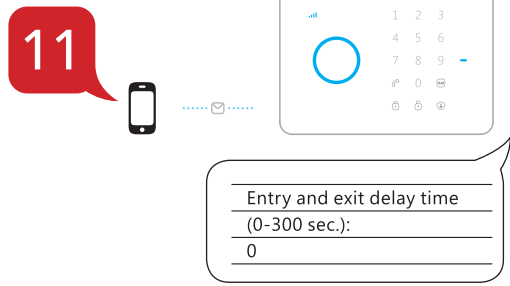

Forward > Edit

Entry and exit delay time (0-300 sec.):
10

Set delay time successfully.

2.26 SIREN VOLUME AND RINGING TIME

Send:

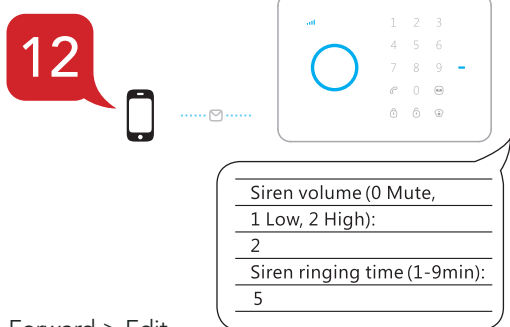

Forward > Edit



Siren volume(0 Mute, 1 Low, 2 High):
1
Siren ringing time(1-9min):
3

Set siren volume and ringing time successfully.

2.27 CHANGE DISARM PASSWORD

Send:

13

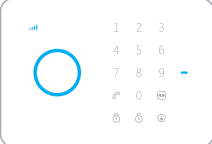
Disarm password(4-6 digits):
1234

Forward > Edit

Disarm password(4-6 digits):
8888

Set disarm password successfully.



NOTE:
It is recommended to change alarm panel password immediately after installation.

2.28 SINGLE ZONE DELAY TIME

When a sensor which is set to Single Zone Delay mode detects intruder, alarm panel will only trigger alarm after this delay time.

Send:

14

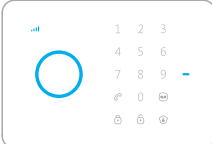
Single zone delay time (0-300 sec.):
30

Forward > Edit

Single zone delay time (0-300 sec.):
15

Set single zone delay time successfully.

2.29 CHANGE SYSTEM LANGUAGE

Send: 0086 to change language to Chinese

0086







中文语言修改成功!

Send: 0001 to change language to English

0001

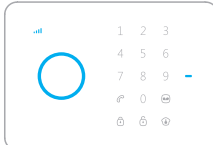
Set English successfully.

2.30 DELETE WIRELESS ACCESSORIES BY SMS

21







Delete wireless accessories successfully.

Or press Tamper Switch 3 times within 3 sec., accessories will be cleared after two beeps.

2.31 DELETE RFID TAGS BY SMS

Send:

22

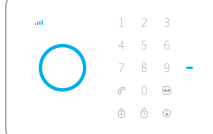



Delete RFID tags successfully.

2.32 RESTORE SYSTEM TO DEFAULT SETTING BY SMS

Send:

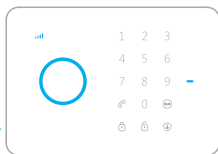
0000



System has been restored to factory setting

2.33 ARM & DISARM BY FREE PHONE CALL

> Arm

1. Call alarm panel by dialling SIM card number.
2. Hang up after hearing ring tone.
3. Alarm panel will call back.
4. Reject the call back.
5. Alarm panel is armed.

> Disarm

1. Call alarm panel by dialling SIM card number.
2. Hold on until alarm panel hangs up the call.
3. Alarm panel will not call back.
4. Alarm panel is disarmed.

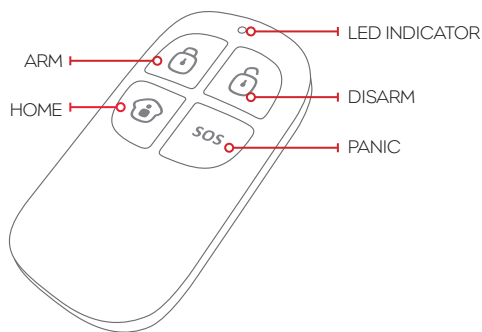

3 WIRELESS REMOTE CONTROL



NOTE:

Do not press and hold more than one button at the time. After a button is pressed, please wait for 5 seconds for the command to be completed.



> Arm

Press (Arm ) to arm the alarm panel. When the alarm panel beeps once and  button illuminates, the system is armed.



When intruders are detected, the siren will hoot to deter the intruder. (The siren turns off after ringing for 1 minute in default setting.) At the same time, the alarm panel dials the pre-stored phone numbers automatically.

> Disarm

Press (Disarm ) to disarm the alarm panel. When the alarm panel beeps twice and  button illuminates, the system is disarmed.



When intruders are detected, siren will keep hooting. Press (Disarm ) to stop siren hooting.



> Home Mode

Press (Home ) to arm the home mode.



All the sensors in Normal Zone are armed except those in Home Mode Zone which are disarmed so that user can move freely at home.

> Mute Mode

Press (Home ) button on the remote control, then press (Arm ) or (Disarm ) button, the siren keeps silent to finish the operation. The system is armed or disarmed in mute without hooting to avoid disturbing other people.



> Emergency Call

No matter what state the control panel is in, once SOS Button on the remote is pressed, the system immediately goes into emergency alarm state.



4 WIRELESS MOTION SENSOR

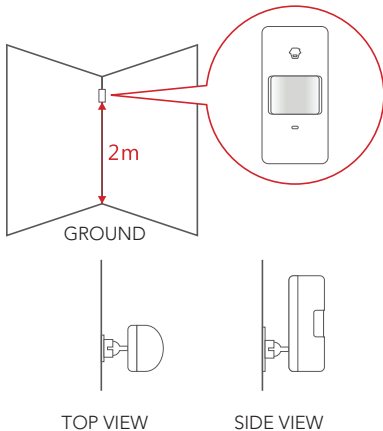

4.1 INSTALLATION AND NOTICES

1. Fix the mounting bracket on the wall with screws and attach the sensor to the bracket.
2. Adjust installation height or bracket to change the detection distance and angle.

It is recommended to mount the sensor at the height of 2m from the ground.

NOTE – the sensor is more sensitive to movement across the sensor rather than towards it, so the sensor functions best when it is positioned to one side of a walkway.

4.2 DETECTION RANGE

NOTE – if two sensors are installed in the same detection range, please adjust the location and height of each unit to avoid interference and false triggering.

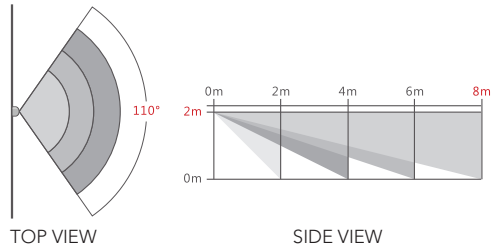

4.3 INTERNAL AND FUNCTIONS

SENSOR – detects the motion of infra-red rays released by human body and animals, or heat sources. Do not touch the sensor and always keep the detection window clean.

TAMPER SWITCH – when the case is opened during armed state, the tamper switch will be triggered and generate a signal to alarm the AM2000 control panel.

LED ON/OFF – set the jumper to ON or OFF position to activate or deactivate LED indication.

ZONE SETTING – set the jumpers to different zone mode for different alarm activation method.

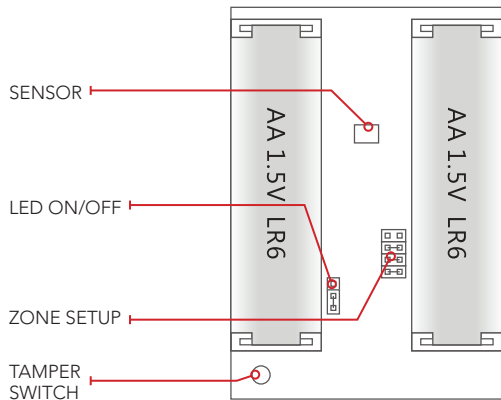

HOME MODE ZONE – when home mode button is pressed on AM2000 control panel or the remote control, it will not trigger the alarm, and therefore occupants can move freely inside the room. Meanwhile other zone setting will remain armed.

NORMAL ZONE – when AM2000 is armed, if intruder detected, it will trigger alarm immediately.

SINGLE DELAY ZONE – when AM2000 is armed, if intruder detected, it will trigger alarm after 30 seconds time delay in default settings.

NOTE: AM2010 PIR motion sensor is set to “HOME MODE ZONE” by default.

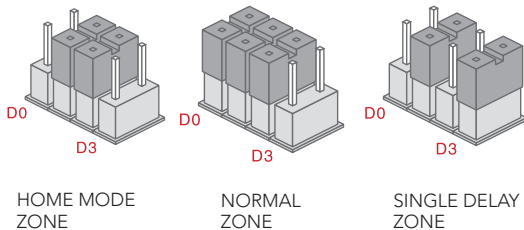

IMPORTANT – WHEN THE ZONE SETTING IS CHANGED, THE SENSOR MUST RE-PAIR WITH AM2000 CONTROL PANEL.

4.4 OPERATION

Open the case with a screw driver and remove the battery insulation strip to power on the sensor. Once the sensor is powered on, it will start self testing for one minute.

TESTING MODE: After self testing, press the test button on the rear of the sensor, the sensor enters into testing mode, and detects once every 10 seconds, walk within the detection range, from left to right or right to left and monitor the LED indicator to ensure the detector is working.

Adjust the sensor angle accordingly to achieve best detection effect. After 3 minutes, the LED flashes twice, and the sensor enters working mode.

WORKING MODE: in working mode, if the sensor is triggered more than twice within 3 minutes, it will enter standby mode to save power. After no movement within next 3 minutes, the sensor goes back to the working mode.

> Pairing with AM2000 control panel

Key in the password and press the connect key on AM2000 control panel, and then press the test button twice on the back of the sensor unit. When one beep sound from the AM2000 control panel is heard, they are paired.

To check if they are connected successfully, arm the AM2000 control panel, trigger the sensor by walking within the detection range after exit delay time; if there is an alarm, the connection is successful.

> LED indication

FLASH CONTINUOUSLY – under self testing mode.

FLASH ONCE – intruder detected.

FLASH TWICE – self testing mode completed, enter to working mode.

FLASH ONCE PER 3 SECONDS – low battery indication, please change batteries immediately, user will get alert SMS for low battery if the PIR motion sensor is connected to AM2000 control panel with GSM enabled.

5 WIRELESS MOTION SENSOR



5.1 INSTALLATION AND NOTICES

1. Slide open the rear case and remove battery insulation strip.
2. Mount the sensor on the door frame and the magnet on the door.
3. Ensure the magnet is on the right side of the sensor where the arrow is located.
4. Place the sensor in the desired location; mount the magnet no more than 10mm away from the sensor and secure the sensor and magnet with double sided tapes (supplied) or screws (not supplied).
5. Avoid mounting sensors in areas with large quantity of metal or electrical wiring, such as full metal frame and door, furnace or utility room.

5.2 INTERNAL AND FUNCTIONS

TAMPER SWITCH – when the case is opened during armed state, the tamper switch will be triggered and generate a signal to alarm the AM2000 control panel.

TAMPER SWITCH

ZONE SETUP

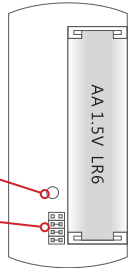

ZONE SETTING – set the jumpers to different zone mode for different alarm activation method.

HOME MODE ZONE – when home mode button is pressed on AM2000 control panel or the remote control, it will not trigger the alarm, and therefore occupants can move freely inside the room. Meanwhile other zone setting will remain armed.

NORMAL ZONE – when AM2000 is armed, if intruder detected, it will trigger alarm immediately.

SINGLE DELAY ZONE – when AM2000 is armed, if intruder detected, it will trigger alarm after 30 seconds time delay in default settings.

NOTE: AM2020 wireless door/window contact sensor is set to "SINGLE DELAY ZONE" by default.

5.3 OPERATION

Pairing with AM2000 control panel

Key in the password and press the connect key on AM2000 control panel, then trigger the sensor by opening the door it is mounted on. When one beep sound from the AM2000 control panel is heard, they are paired.

To check if they are connected successfully, arm the AM2000 control panel, trigger the sensor unit by opening the door it is mounted on; if there is an alarm, the connection is successful.

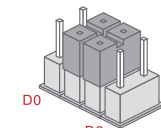

HOME MODE ZONE

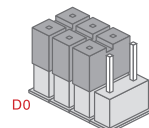

NORMAL ZONE

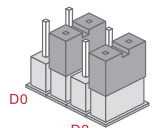

SINGLE DELAY ZONE

IMPORTANT – When the zone setting is changed, the sensor must re-pair with am2000 control panel.

6 SPECIFICATIONS

> ALARM PANEL

Power Supply	DC 12V 500mA
Power Consumption	5W (Max)
GSM Frequency	850/900/1800/1900MHz
Radio Frequency	433MHz
Backup Battery	2 x Lithium-ion 3.7V/800mAh (Included)
Inbuilt Siren	110dB
Operating Temperature	10°C~55°C
Operating Humidity	≤ 80% (non-condensing)
Dimensions	188mm (L) x 132mm (W) x 26mm (H)

> PIR MOTION SENSOR

Power Supply	DC 3V (2 x AA Alkaline Battery Included)
Power Consumption	0.03W (Max)
Detection Scope	8m/110°
Wireless Range	Up to 50m*
Radio Frequency	433MHz
Operating Temperature	-10°C~55°C
Operating Humidity	≤ 80%
Dimensions	Sensor: 108mm (L) x 52mm (W) x 36.8mm (H) Bracket: 52mm (L) x 30mm (W) x 26.5mm (H)

> DOOR/WINDOW CONTACT SENSOR

Power Supply	DC 1.5V (AA Alkaline Battery Included)
Power Consumption	0.06W (Max)
Wireless Range	Up to 50m*
Radio Frequency	433MHz
Operating Temperature	10°C~55°C
Operating Humidity	≤ 80%
Dimensions	Sensor: 71mm (L) x 34mm (W) x 17.5mm (H) Magnet: 51mm (L) x 12mm (W) x 13.5mm (H)

* Range depends on location, temperature and battery conditions.

7 WARNING

- > Do not drop, puncture, or violently shake the unit.
- > Do not mount, directly expose or put near to the sun, water, air conditioner, refrigerator radio transmitting devices, metal objects, heater, oven, any heat sources, rapid temperature changing or high air flow locations.
- > Do not cover the unit, mount the unit on adequate locations and heights.
- > Handle the unit with care, avoid unnecessary force or impact.
- > This unit is for indoor use only.

8 ALARM MONITORING SERVICE

For added security, use this alarm system in conjunction with alarm monitoring service for rapid response to an emergency.

Contact your local alarm monitoring service provider to establish a response plan.

9 TROUBLESHOOTING GUIDE

PROBLEM	POSSIBLE CAUSE	SUGGESTED REMEDY
No power or not powering up	Battery is loose/ low battery or power supply is unplugged.	Check battery and power supply installation. Check power point. Ensure battery and power supply are secured.
No LED indication	LED indication is turned off. Battery is loose, unplugged or low battery.	Replace battery, alkaline type battery recommended. Ensure battery is secured. Turn on AM2010 Motion Sensor LED by setting the jumper to ON position.
Poor/No signal on sensors	Signal interference, out of transmission range or low battery.	Relocate sensors away from water, air conditioner, refrigerator radio transmitting devices, metal objects, heater, oven, any heat sources, rapid temperature changing, high air flow locations or major obstacles. Relocate sensors closer to AM2000 alarm panel. Replace battery on all sensors and check power supply on AM2000 alarm panel.
Poor/ No signal on GSM network		Check the SIM card is activated and has sufficient credit. Check the SIM card is compatible to the GSM network 850/900/1800/1900MHz. Check the SIM card account periodically to ensure there is sufficient credit for the GSM SMS function to operate correctly.
No interaction between sensor and AM2000 control panel	The sensor and AM2000 alarm panel are not paired.	Please pair the sensor and AM2000 alarm panel following pairing instruction.

10 WARRANTY

Arlec guarantees this product in accordance with the Australian Consumer Law. Arlec also warrants to the original first purchaser of this product ("you") from a retailer that this product will be free of defects in materials and workmanship for a period of 12 months from the date of purchase; provided the product is not used other than for the purpose, or in a manner not within the scope of the recommendations and limitations, specified by Arlec, is new and not damaged at the time of purchase, has not been subjected to abuse, misuse, neglect or damage, has not been modified or repaired without the approval of Arlec and has not been used for commercial purposes ("Warranty").

If you wish to claim on the Warranty, you must, at your own expense, return the product, and provide proof of original purchase and your name, address and telephone number, to Arlec at the address below or the retailer from whom you originally purchased the product within 12 months from the date of purchase.

Arlec will (or authorise the retailer to) assess any claim you may make on the Warranty in the above manner and if, in Arlec's reasonable opinion, the Warranty applies, Arlec will at its own option and expense (or authorise the retailer to) replace the product with the same or similar product or repair the product and return it to you or refund the price you paid for the product. Arlec will bear its own expenses of doing those things, and you must bear any other expenses of claiming on the Warranty.

The Warranty is in addition to other rights and remedies you may have under a law in relation to the product to which the Warranty relates.

Our goods come with guarantees that cannot be excluded under the Australian Consumer Law. You are entitled to a replacement or refund for a major failure and for compensation for any other reasonably foreseeable loss or damage. You are also entitled to have the goods repaired or replaced if the goods fail to be of acceptable quality and the failure does not amount to a major failure.

Arlec Australia Pty. Ltd. ACN 009 322 105 ("Arlec") gives the Warranty. Arlec's telephone number, address and email address are:
Customer Service: (03) 9982 5111
Building 3, 31 – 41 Joseph Street, Blackburn North, Victoria, 3130
Blackburn North LPO, P.O. Box 1065, Blackburn North, 3130
Email: custservice@arlec.com.au