

MITSUBISHI

Wireless LAN Adapter NZ2WL-US/NZ2WL-EU/ NZ2WL-CN/NZ2WL-KR/ NZ2WL-TW User's Manual

Powered by CONTEC

This product was jointly developed and manufactured by Mitsubishi and CONTEC.

Note that some of the warranty on this product differs from that on other products (MELSEC iQ-R or MELSEC-Q/MELSEC-L series).
(Refer to "Terms of Warranty".)

MODEL	NZ2WL-U-E
MODEL CODE	13JZ55
IB (NA) -0800471ENG-D (1511) MEE	

Precautions regarding Warranty and Specifications

This product was jointly developed and manufactured by Mitsubishi and CONTEC.

Note that there are some precautions regarding warranty and specifications of the product.

< Warranty >

The gratis warranty term of the product shall be for one (1) year after the date of delivery or for eighteen (18) months after manufacturing, whichever is less.

- The onerous repair term after discontinuation of production shall be for six (6) years.
- Mitsubishi shall mainly replace products that need repair.
- It may take some time to respond to the problem or repair the product depending on the condition and timing.

< Specifications >

- General specifications are different.

	NZ2WL-xxx	MELSEC-Q Series
Operating ambient temperature	0 to 50°C	0 to 55°C
Operating ambient humidity	10 to 90%RH	5 to 95%RH
Storage ambient temperature	-10 to 60°C	-25 to 75°C
Storage ambient humidity	10 to 90%RH	5 to 95%RH

- R&TTE standards that are applicable to the products differ.

	NZ2WL-EU	MELSEC-Q Series
R&TTE standards	EN300 328/EN301 893/EN301 489-1,-17/ EN55022/EN55024/EN61000-3-2,-3-3/EN60950-1	EN61131-2

Safety Precautions

Review the following definitions and precautions to use the product safely.

Safety Information

This document provides safety information using the following symbols to prevent accidents resulting in injury or death and the destruction of equipment and resources. Review the meanings of these labels to operate the equipment safely.

⚠ DANGER	DANGER indicates an imminently hazardous situation which, if not avoided, will result in death or serious injury.
⚠ WARNING	WARNING indicates a potentially hazardous situation which, if not avoided, could result in death or serious injury.
⚠ CAUTION	CAUTION indicates a potentially hazardous situation which, if not avoided, may result in minor or moderate injury or in property damage.

Usage limitation

This product has not been developed or manufactured to be used in systems including equipment which is directly related to human lives or equipment^{*1} which involves human safety and may significantly affect the maintenance of public functions^{*2}. Therefore, do not use the product for such purposes.

*1: Medical devices such as life-support equipment and devices used in an operating theater.

*2: Main control systems at nuclear power stations, safety maintenance systems at nuclear facilities, other important safety-related systems, operation control systems within group transport systems, air-traffic control systems, etc.

Precautions Related to Maintenance

Clean this product by wiping lightly with a soft cloth moistened with water or a neutral detergent. Avoid using benzene, thinners or other volatile solutions that may cause deformation or discoloration.

Supported Wireless Networking Standards

This product conforms with IEEE 802.11a and IEEE 802.11b/g.

It can be set to the channels corresponding to the countries listed below.

Standard	Channel*1				
	U.S.A. (NZ2WL-US)	Europe (NZ2WL-EU)	China (NZ2WL- CN)	Korea (NZ2WL-KR)	Taiwan (NZ2WL- TW)
IEEE802.11a	36, 40, 44, 48, 149, 153, 157, 161, 165ch	36, 40, 44, 48ch	149, 153, 157, 161, 165ch	36, 40, 44, 149, 153, 157, 161ch	149, 153, 157, 161, 165ch
IEEE802.11b/g	1-11ch	1-13ch	1-13ch	1-13ch	1-11ch

*1 The channels of this product can be changed only among the same models.

Security Precautions

Wireless LAN uses radio waves instead of LAN cables to send and receive data between a computer and a wireless access point, making it possible to freely establish a LAN connection within a range of the radio waves.

However, radio waves can be received through obstacles, such as walls, when within the range. Therefore, if security settings are not made, the following problems may occur.

Unauthorized viewing of data

An unauthorized third party can intercept the radio waves and view e-mail messages and personal information, such as user ID and password or your credit card information.

Unauthorized access

An unauthorized third party can access a personal or corporate network and cause the following damage:

- Intercepting personal information and confidential information (information leak)
- Using a false identity to communicate and disclose information illegally (identity theft)
- Changing and transmitting intercepted data (tampering)
- Damaging data and systems by spreading a computer virus (destruction)

The wireless LAN card and wireless access point have security features to counter these problems. Using the security settings of the wireless LAN equipment can help prevent these problems from occurring.

The security settings of the wireless LAN equipment are not configured at the time of purchase.

To reduce security problems, configure all security settings of the wireless LAN equipment according to the manual before using the wireless LAN card and wireless access point.

Please be aware that the security settings do not provide complete security protection due to wireless LAN specifications. If you are unable to configure the security settings yourself, please contact your local authorized dealer.

The customer is responsible for configuring the security settings and understanding the risks inherent in using the product without the security settings configured.

Handling Precautions

WARNING

- Do not use the product where it is exposed to flammable or corrosive gas. Failure to do so may result in an explosion, fire, electric shock, or failure.
 - The product could be very hot in the operation. Please do not touch with hands or body. It may cause burns.
 - To avoid electric shock, please do not touch the system with a wet hand.
-

CAUTION

- As this product contains precision electronic components, do not use or store it in a place subject to shock or vibration. Doing so may cause malfunction, heat generation, fault, or damage.
 - Ground the FG terminal to a protective ground conductor.
 - Place the cables in a duct or clamp them. If not, dangling cable may swing or inadvertently be pulled, resulting in damage to the product or cables or malfunction due to poor contact.
 - When disconnecting the communication cable or power cable from the product, do not pull the cable by the cable part.
 - Correctly connect the power cables to the product.
 - Do not install control lines or communication cables together with the main circuit lines or power cables. Keep a distance of 100mm or more between them. Failure to do so may result in malfunction due to noise.
 - Prevent foreign matter such as dust or wire chips from entering the product. Such foreign matter can cause a fire, failure, or malfunction.
 - Do not use or store the product in a hot or cold place, or in a place that is subject to severe temperature changes. Doing so may cause malfunction, heat generation, fault, or damage.
 - Do not use or store the product in a place subject to direct sunlight or near a heating device, such as a stove. And do not use or store the product near equipment generating a strong magnetic field or radio waves. Doing so may cause malfunction, heat generation, fault, or damage.
 - Do not use or store this product in the presence of chemicals.
 - Do not use this product in extremely humid or dusty locations. It is extremely dangerous to use this product if the interior contains water or any other fluid or conductive dust.
 - If you notice abnormal odor or overheating, please disconnect the power cable immediately.
 - If you find a fault or other abnormality (bad smell or excessive heat), unplug the power terminal connector and then contact your local authorized dealer.
 - Do not open the product casing. Mitsubishi will disclaim any responsibility for products whose casing has been opened.
 - Do not modify the product. Mitsubishi will bear no responsibility for any problems, etc., resulting from modifying the product.
 - To clean this product, gently wipe it with a soft cloth soaked with water or a neutral detergent. Do not use benzene, paint thinner, or other volatile solvents as they can cause the coating to discolor or peel off.
 - The specifications of this product are subject to change without notice because of function addition and quality improvement. Even when using the product continuously, read the user's manual and check the contents.
 - If you move or transfer the product, make sure provide this manual with the product.
 - Regardless of the foregoing statements, Mitsubishi is not liable for any damages whatsoever (including damages for loss of business profits) arising out of the use or inability to use this Mitsubishi product or the information contained herein.
 - This product is equipped with a fuse (current rating: 2A) to prevent burning of the unit from overvoltage. (This fuse is not user serviceable.) See the warranty for information on coverage during fuse interruptions.
 - FG and SG of this product are connected inside the module. Be cautious of the noise from the FG.
 - The negative electrode (Vi-) terminal and the FG terminal of this product's power supply terminal are connected to the metal casing. Note that negative grounding is performed when the FG terminal is grounded or when the device to which the metal casing is attached is grounded.
-

- By grounding the FG terminal, this product is negatively grounded, so note that connecting a positively grounded device to this product may cause malfunction, heat generation, faults, or damage.
- Note that an electrical potential difference existing between the ground of this product and the negative ground of its power supply may cause malfunction, heat generation, faults, or damage.
- FCC PART15, R&TTE Directive, NCC Certification addenda (for USA, Europe, and Taiwan only)
The NZ2WL-US , NZ2WL-EU, and NZ2WL-TW comply with FCC PART15, the R&TTE Directive, and the NCC Certification when used under the following conditions.
 - Attach ferrite cores to the power supply line and the FG line.
 The following picture shows the ferrite cores attached to the cable.

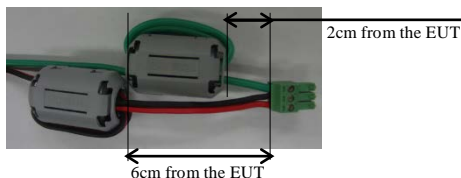

Attach ferrite cores to the FG line (2cm from the EUT) and the power supply line (6cm from the EUT), and turn the cable three times (wind it twice).

FCC Part 15 Notice

FCC WARNING

Changes or modifications not expressly approved by the party responsible for compliance could void the user's authority to operate the equipment.

This transmitter must not be co-located or operated in conjunction with any other antenna or transmitter. This equipment complies with FCC radiation exposure limits set forth for a controlled environment and meets the FCC radio frequency (RF) Exposure Guidelines in Supplement C to OET65. This equipment should be installed and operated keeping the radiator at least 20cm or more away from person's body (excluding extremities: hands, wrists, feet and ankles).

Ferrite cores must be used with the power supply line and FG line to suppress radio frequency interference.

FCC Part 15 Subpart B class A Notice

Note: This equipment has been tested and found to comply with the limits for a Class A digital device, pursuant to part 15 of the FCC Rules. These limits are designed to provide reasonable protection against harmful interference when the equipment is operated in a commercial environment. This equipment generates, uses, and can radiate radio frequency energy and, if not installed and used in accordance with the instruction manual, may cause harmful interference to radio communications. Operation of this equipment in a residential area is likely to cause harmful interference in which case the user will be required to correct the interference at his own expense.

FCC Part 15 Subpart E Notice

Operations in the 5.15-5.25GHz band are restricted to indoor usage only.

Compliance with FCC requirement 15.407(c)

Data transmission is always initiated by software, which is then passed down through the MAC, through the digital and analog baseband, and finally to the RF chip. Several special packets are initiated by the MAC.

These are the only ways the digital baseband portion will turn on the RF transmitter, which it then turns off at the end of the packet. Therefore, the transmitter will be on only while one of the aforementioned packets is being transmitted. In other words, this device automatically discontinues transmission in case of either absence of information to transmit or operational failure.

Frequency tolerance: $\pm 30\text{ppm}$

Connection to MELSEC Series Equipment

The NZ2WL Series can be connected to various programmable controllers and display units.

Connectable Equipment

The following MELSEC Series equipment can be connected. *1

Type	Model
Programmable Controller	MELSEC iQ-R Series Ethernet Interface Module with Built-in CC-Link IE *4
	MELSEC-Q Series Ethernet Interface Module (for 10BASE-T/100BASE-TX) *2
	MELSEC-L Series Ethernet Interface Module
	CC-Link IE Field Network Ethernet Adapter Module *3
	Industrial Switching HUB
	MELSEC iQ-R Series CPU Module *4
	MELSEC-Q Series CPU Module (with Built-in Ethernet)
	MELSEC-L Series CPU Module
	MELSEC iQ-R Series C Controller Module
	MELSEC-Q Series C Controller Module
HMI	GOT2000 Series Main Unit
	GOT2000 Series Wireless LAN Communication Unit
	GOT1000 Series Main Unit (with Built-in Ethernet)
	GOT1000 Series Ethernet Communication Unit
Motion Controller	Motion Controller MELSEC iQ-R Series Motion CPU Module
	Motion Controller Q Series Motion CPU Module
	Motion Controller Q Series Motion CPU Module (for the iQ Platform)
CNC	Motion Controller Q Series Stand-Alone Motion Controller
	MITSUBISHI CNC M700/M70 Series
	MITSUBISHI CNC M700V/M70V Series
Software	MITSUBISHI CNC C70 Series
	GX Works3
	GX Works2
	MX Component
	MX Sheet
	CPU Module Logging Configuration Tool
	High Speed Data Logger Module Configuration Tool
	GX LogViewer
	GX IEC Developer
	PX Developer
	PX Developer Monitor Tool
	CW Configurator
	Setting / Monitoring Tools for the C Controller Module
	CW Workbench
	GT Works3
	MT Works2
CNC Remote Operating Tool (NC Monitor/NC Explorer)	

*1 The manuals of some of these products may indicate that operations cannot be guaranteed when connected using a wireless network other than that using this wireless LAN equipment. Before using this product, please read "Note on Connections" on the next page.

*2 Before using this product with Ethernet interface modules, please read "Note on Connection with Ethernet Interface Module" on the next page.

*3 The NZ2WL series can be connected only to the Ethernet part of this module. The NZ2WL series cannot be connected to the CC-Link IE Field Network part of this module.

*4 It can only be used to connect to the Ethernet. It can not be used in connecting with other networks.

Note on Connections

CAUTION

- Do not use this product for applications that must transmit or update data regularly or within a given time period, such as the cyclic transmission of a programmable controller. Transmission delays cannot be obtained through calculations for Ethernet communications using this product.
 - Use this product with the access point and station in visual range of each other (so that the antenna on one device is visible from the antenna on the other device).
-
- During an Ethernet connection using wireless LAN, packets may be lost due to the peripheral environment and equipment location, and the connection may not be as stable as with a wired Ethernet connection. Be sure to check operations when using this product. Packets may be frequently lost especially during broadcasts. In this case, use a user application or use UDP or TCP with a specified IP address for the client.
 - If the timer value set for the MELSEC Series equipment connected to this product is large, it may take time to detect the loss of packets, and communications may appear to have stopped.*1 In this case, changing the timer value may fix the problem.
 - Do not directly connect MELSOFT products by Ethernet port (simple connection) through wireless LAN to the MELSEC iQ-R Series CPU Module, MELSEC-Q Series CPU Module (Ethernet built-in type), or the MELSEC-L Series CPU Module.
 - For additional restrictions and notes on using a wireless LAN connection, see the manual of the MELSEC products to which this product is connected.
 - This product cannot be directly connected to a CC-Link IE Field Network. A wired Ethernet connection must be made using an optional CC-Link IE Field Network Ethernet adapter module.
 - If a problem occurs, but there is nothing wrong with the settings or usage of MELSEC products connected to this product or the Ethernet wire, there may be a problem with the setup or settings of this product. Refer to "Chapter 7 Troubleshooting" and check the operations of this product. You can also refer to the user's manuals of the MELSEC products connected to this product.

*1 For example, the default value of the response monitoring timer of the Ethernet Interface Module is 30 seconds, so it takes 30 seconds to detect packet losses.

When using the product with the MELSEC-Q/L Series Ethernet

Interface Module

- When connecting this product with an Ethernet interface module, the COM.ERR.LED of the Ethernet interface module may turn on (error code: C04B_H, etc.) due to some reasons such as packet loss. Communication can be performed with the COM.ERR.LED turned on. However, check carefully that the system works as expected.
Regarding how to turn off the COM.ERR.LED, see the "Q Corresponding Ethernet Interface Module User's Manual (Basic)" or the "MELSEC-L Ethernet Interface Module User's Manual (Basic)."
- When the COM.ERR.LED frequently turns on, the following operations may reduce the frequency:
 - Use TCP on the connection.
 - Enable TCP segmentation*2.To enable TCP segmentation, set 5B4_H to the TCP Maximum Segment Transmission setting area (address: 1E_H) and execute reinitialization.
For reinitialization, see the "Q Corresponding Ethernet Interface Module User's Manual (Basic)" or the "MELSEC-L Ethernet Interface Module User's Manual (Basic)."

*2 Configuration of the TCP Maximum Segment Transmission setting area is only available with either the MELSEC-Q Series Ethernet Interface Module, or the MELSEC-L Series Ethernet Interface Module along with their upper five serial number starting from 05051. There are limitations on combining the Ethernet Interface and the MELSOFT products. See the "Q Corresponding Ethernet Interface Module User's Manual (Basic)" or the "MELSEC-L Ethernet Interface Module User's Manual (Basic)" for details.

CONDITIONS OF USE FOR THE PRODUCT

- (1) Mitsubishi programmable controller ("the PRODUCT") shall be used in conditions;
 - i) where any problem, fault or failure occurring in the PRODUCT, if any, shall not lead to any major or serious accident; and
 - ii) where the backup and fail-safe function are systematically or automatically provided outside of the PRODUCT for the case of any problem, fault or failure occurring in the PRODUCT.
- (2) The PRODUCT has been designed and manufactured for the purpose of being used in general industries.

MITSUBISHI SHALL HAVE NO RESPONSIBILITY OR LIABILITY (INCLUDING, BUT NOT LIMITED TO ANY AND ALL RESPONSIBILITY OR LIABILITY BASED ON CONTRACT, WARRANTY, TORT, PRODUCT LIABILITY) FOR ANY INJURY OR DEATH TO PERSONS OR LOSS OR DAMAGE TO PROPERTY CAUSED BY the PRODUCT THAT ARE OPERATED OR USED IN APPLICATION NOT INTENDED OR EXCLUDED BY INSTRUCTIONS, PRECAUTIONS, OR WARNING CONTAINED IN MITSUBISHI'S USER, INSTRUCTION AND/OR SAFETY MANUALS, TECHNICAL BULLETINS AND GUIDELINES FOR the PRODUCT.

("Prohibited Application")

Prohibited Applications include, but not limited to, the use of the PRODUCT in;

- Nuclear Power Plants and any other power plants operated by Power companies, and/or any other cases in which the public could be affected if any problem or fault occurs in the PRODUCT.
- Railway companies or Public service purposes, and/or any other cases in which establishment of a special quality assurance system is required by the Purchaser or End User.
- Aircraft or Aerospace, Medical applications, Train equipment, transport equipment such as Elevator and Escalator, Incineration and Fuel devices, Vehicles, Manned transportation, Equipment for Recreation and Amusement, and Safety devices, handling of Nuclear or Hazardous Materials or Chemicals, Mining and Drilling, and/or other applications where there is a significant risk of injury to the public or property.

Terminology/Abbreviations

The following terms and abbreviations are used in this manual for convenience.

Full term	Term used in this manual
All five NZ2WL models (NZ2WL-US, NZ2WL-EU, NZ2WL-CN, NZ2WL-KR, NZ2WL-TW)	NZ2WL-xxx
NZ2WL-US (for U.S.A.)	US
NZ2WL-EU (for Europe)	EU
NZ2WL-CN (for China)	CN
NZ2WL-KR (for Korea)	KR
NZ2WL-TW (for Taiwan)	TW
Access point only supported	(AP only)
Station only supported	(ST only)
A device with the wireless function	Wireless terminal
Personal computer	PC

Speed Notation

The link speed values (such as 54 Mbps) of the transmission rate used in this manual and setting screens are the theoretical maximum values of the wireless LAN standard and do not indicate the actual data transmission speed.

Packing List

Thank you for purchasing this Mitsubishi product.

The product package should contain the items listed below.

Use the following list to confirm the contents of the product package.

If you discover any damaged or missing item, contact your local authorized dealer.

Contents

Name	Pcs.
Main unit (NZ2WL-xxx)	1
Antenna, rubber cap for antenna	2
User's Manual	1
Power terminal connector	1
Retention bracket	1
Mounting bracket	1
Bracket screw M3 x 6	3
Setup manual (CN, KR, TW only)	1
Ferrite core (US, EU, TW only)	2

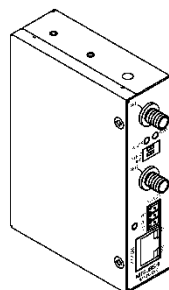

Main unit

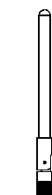

Antenna x 2

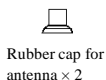

Rubber cap for antenna x 2



Power terminal



Retention bracket



Bracket screw M3 x 6 x 3



Mounting bracket

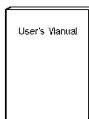

User's Manual

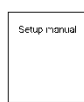

Setup manual
(CN, KR, TW only)



Ferrite core x 2
(US, EU, TW only)

CAUTION

To operate this product, a power supply (12-24VDC±5%) is required separately. For power supply, see Chapter 2, Part Names and Settings, "Power Supply".

- This document, in whole or in part, may not be reproduced without permission.
 - This document is subject to change without notice at any time.
 - While we are doing our best to ensure this document has no error, should you have any questions or find any omissions or similar, consult your local authorized dealer.
 - MS, Microsoft, Windows, Windows NT, and MS-DOS are registered trademarks or trademarks of Microsoft Corporation in the U.S.A. and other countries.
Mozilla, Firefox, and the Firefox logo are trademarks or registered trademarks of Mozilla Foundation in the U.S. and other countries.
- All other company names and products used in this manual are trademarks or registered trademarks of their respective companies. This manual does not use the symbols such as ™, ®, and ©.

Table of Contents

Packing List x

1.	BEFORE USING THE PRODUCT	1
-----------	---------------------------------	----------

Overview 1

 Features 1

 Environment 3

 Inspection 3

 Storage 3

 Disposal 3

2.	SETUP	4
-----------	--------------	----------

Part Names and Functions 4

 LED display 4

 DIP switches 5

 Connectors 6

Checking the Network Addresses 6

Attaching the Antennas 7

 FCC PART15, R&TTE Directive, NCC Certification addenda (for USA, Europe, and Taiwan only) 7

Power Supply 8

Attaching a retention bracket 8

Grounding the NZ2WL 9

Installation 10

 Using Mounting Brackets 10

Wired LAN Connection 11

3.	CONNECTING TO DEVICES AND SETUP METHODS	12
-----------	--	-----------

Setup Methods 12

Preparation before Setup 12

Setup Using Web Browser 13

 Setting the Browser 13

 Connecting to This Product Using Web Browser 14

 Setup Using Web Browser 15

Setup Using TELNET 16

 Connecting to the Product Using TELNET 16

 Setup Using TELNET 18

 TELNET Key Operation 19

4.	WIRELESS LINK MODE AND WIRELESS LAN FUNCTION	20
-----------	---	-----------

Wireless Link Mode.....	20
Standard Infrastructure Mode	20
Compatible Infrastructure Mode	21
Advanced Infrastructure Mode	22
Comparison of Main Functions	23
Installation in a Network	25
Features of the Wireless Network	25
Operating Environment and Radio Waves	26
Constructing a Network	27

5.	SETUP AND STATUS DISPLAY	28
-----------	---------------------------------	-----------

Settings.....	28
◆ Basic setting	28
◆ Ethernet.....	30
◆ Wireless LAN	31
◆ IEEE802.1X	42
◆ Extension	43
◆ SNMP	46
◆ VLAN	48
◆ Log	49
Status Display	50

6.	MAINTENANCE	57
-----------	--------------------	-----------

Maintenance Tool.....	57
Log File Collection	57
Collecting Log Files Using FTP.....	57
Saving a Setting File	58
Saving Setting File Using FTP	58
Restoring the Software Settings.....	59
Restore Settings Using FTP.....	59
Time Setting	60
Initialization.....	60
Using TELNET	60
Using a Web Browser.....	61
Using the DIP Switch (INIT).....	61

7.	TROUBLESHOOTING	62
	When Communication Fails	62
	Setup Screen Unavailable on Web Browser	63
	When the Product Does Not Start	63
8.	APPENDIX	64
	BShardware Setup	64
	Initial Setting	64
	Specifications.....	69
	Software Specifications	70
	Installation Environment Requirements (Environmental Specifications).....	70
	External Dimensions	71
	Pin Layout of LAN Port	71
	WARRANTY	72
	R&TTE Directive.....	74

1. Before Using the Product

This chapter provides information you should know before using the product.

Overview

The NZ2WL-xxx is a wireless LAN adapter that conforms to IEEE 802.11a/b/g standards of various countries and features a wide input power supply (12 to 24 VDC) and can be configured either as an access point or station.

This product features WPA2/WPA security functions (AP only), multi-client function (ST only), extended range (XR) function, Super A/G function, Wireless Distribution System (WDS) function, Quality of Service (QoS) function, and other functions.

Please read this manual carefully before using the product.

The NZ2WL Series uses a wireless LAN chip set manufactured by Atheros Communications Inc. The main board, firmware, and the enhanced feature have been developed and equipped.

Features

■ The wireless LAN adapter that conforms to IEEE 802.11a/b/g standards and can be configured either as an access point or station.

This product conforms to IEEE 802.11a/b/g standards, the channel can be set depending on the country, and it can be configured either as an access point or station.

■ High-level security features equipped *1

The product is equipped with WPA2/WPA, the latest security standards. The product also supports IEEE 802.1X authentication in addition to the AES, AES-OCB, and WEP (64/128/152-bit) encryption. Original encryption functions are also equipped. Those functions include WSL, an original encryption technology, that can be used with WPA2/WPA or WEP as well as MAC address filtering, ESSID hide, and ANY ID reject.

■ IP tunneling function equipped *2

An IP tunneling function enables communication even at roaming destinations beyond the router range without changing the network configuration.

■ Offering three wireless connection modes according to network configurations

Standard *3 : Mode to use the features unique to the NZ2WL Series, such as IP tunneling and WSL

Compatible *3 : Mode for heterogeneous use along with other vendors' wireless equipment supporting Wi-Fi *4

Advanced *3 : Mode to allow wireless LAN terminals both in standard mode and compatible mode to be connected on the network at the same time (only AP)

■ XR function equipped *5

The XR (eXtended Range) function developed by Atheros Communications Inc. greatly extends the range of the wireless LAN communication area. This is useful for providing a stable connection such as at locations where radio wave interference may occur or where obstacles create "dead zones".

■ Super A/G feature equipped

The product is equipped with super A/G feature that improves communication speed. The communication speed of the wireless LAN can be increased between supported models.

■ WDS feature equipped *6

Up to six units can be connected wirelessly between access points.

■ QoS support

Bands are secured for specific communication, such as VoIP, and communication quality is guaranteed.

■ SNMP agent feature equipped

The feature enables network management using SNMP supported network management software.

■ Protect Mode available when using IEEE802.11g

Stable communications are enabled even when IEEE802.11b-compliant products are also used.

Communication speeds are improved for IEEE802.11g-compliant products.

■ Others

- Introducing the Diversity Method with a built-in chip antenna.
- Easy configuration and management using a Web browser. Various maintenance methods are available according to systems and applications, including FTP commands and TELNET.

*1 WPA2/WPA, IEEE 802.1X authentication, MAC address filtering, ESSID hide, and ANY ID reject can be used only when the product is configured as an access point.

*2 The IP tunneling function can be used in standard wireless connection mode.

*3 The official names are as follows:

Standard ●●● Standard Infrastructure

Compatible ●●● Compatible Infrastructure

Advanced ●●● Advanced Infrastructure

*4 Compatible mode does not guarantee inter-connectivity with other vendors' Wi-Fi products.

*5 The XR feature can be used only when both of the access point and station in the wireless LAN support the XR feature.

*6 The WDS function is available only when the product is configured as an access point.

Environment

Use this product in the following environment.

If used under environmental conditions exceeding these ranges, the board may overheat, malfunction, or cause a failure.

Operating ambient temperature

0 - 50°C

Operating ambient humidity

10 - 90%RH (No condensation)

Corrosive gases

None

Floating dust particles

Small amounts (non excessive)

Inspection

Inspect the product periodically as follows to use it safely.

Storage

When storing this product, keep it in its original packing form.

- (1) Put the main unit in the storage bag.
- (2) Wrap it in the packing material, then put it in the box.
- (3) Store the package at room temperature at a place free from direct sunlight, moisture, shock, vibration, magnetism, and static electricity.

Disposal

When disposing of the product, follow the disposal procedures stipulated under the relevant laws and municipal ordinances.

2. Setup

The antenna must be mounted and installed properly before configuring this product. Follow the setup procedure for the product shown below.

Part Names and Functions

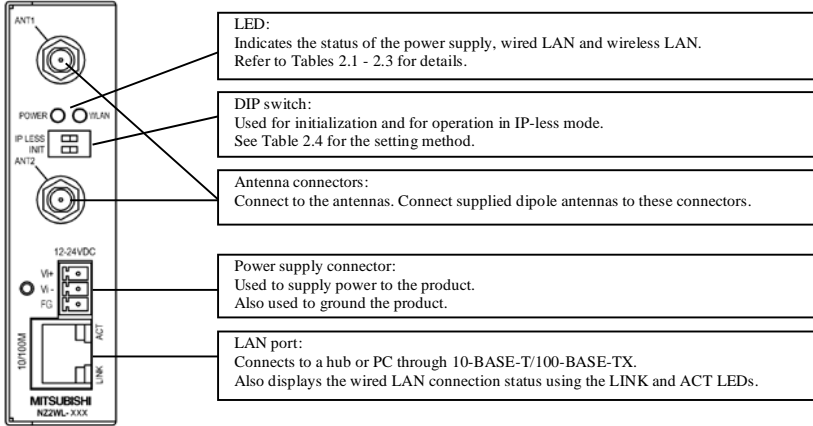

Figure 2.1. Part names

LED display

Table 2.1. LED Displays during Normal Operation

LED name	Status	LED display
POWER	ON	Indicates that the device is operating.
	Flashing	Indicates that the device is being started (going to operate after the power switch was turned on)
WLAN	ON	When the product is configured as an access point, the LED being ON indicates that one or more stations are logged in the product. When the product is configured as a station, the LED being ON indicates that the product is logged in an access point.
	Flashing	Indicates data is being transmitted to or received from the device connected through wireless LAN.
	OFF	When the product is configured as an access point, the LED being OFF indicates that no station is logged in the product. When the product is configured as a station, the LED being OFF indicates that the product is not logged in an access point.
LINK (LAN)	ON	Indicates that a wired LAN has been connected.
	OFF	Indicates that a wired LAN is not connected.
ACT (LAN)	Flashing	Indicates that the product is transmitting/receiving data to/from the connected terminal through wired LAN.
	OFF	Indicates that the product is not transmitting/receiving data to/from the connected terminal through wired LAN.

Table 2.2. During File Write

LED name	Status	LED display
POWER	Flashing simultaneously	File write in progress *1
WLAN		

*1 Except writing of log files (no flashing)

Do not restart or turn off the module during the File writing.

Table 2.3. Error Display

LED name	Status	LED display
POWER	Flashing twice	Wireless LAN error
WLAN	ON	

DIP switches









Table 2.4. DIP Switches

	ON	OFF	Operation / function
1	INIT	-	Turning on this switch flashes the POWER and WLAN LEDs. If the switch is turned off before the LEDs change their status from flashing to ON (about 3 seconds), all the settings are restored to the default settings after the product is started next time. Reboot the product after the LEDs stop flashing. *1
2	IP LESS	-	Turning on this switch allows the product to operate without the IP address setting. The switch is used when an IP address is not allocated to the product at the setup of a station. In this case, the TELNET, FTP, settings by Web browser, and SNMP agent function cannot be used.

*1 The flashing continues for a little while after the product is switched off during initialization by switching on and off the INIT switch. This indicates internal memory files are being deleted. The internal memory files may be damaged and the product may not start up properly if the power is switched off before the flashing stops. Always reboot the product after the flashing stops.

Connectors

Table 2.5. Power Connectors

Name	Function																
Power connector	<p>Power terminal connector (included in the package): MC1,5/3-ST-3,5 (made by Phoenix Contact Inc.)</p> <p>The applicable cable is AWG28-16. (The cable length must meet the power supply specifications.)</p> <p>The applicable bar solderless terminals are AI0,25-6BU, AI0,34-6TQ and AI0,5-6WH (made by Phoenix Contact Inc.)</p> <p>Secure the connector with a retention bracket. Connect the power cable to the power terminal connector by screw connection.</p> <p>The fastening torque range is 0.22 to 0.25Nm.</p>																
	<table border="1"> <thead> <tr> <th>Power connector</th> <th>MC1,5/3-G-3,5 (Phoenix Contact)</th> </tr> </thead> <tbody> <tr> <td colspan="2" style="text-align: center;"> 12-24VDC Vi+  Vi-  FG  </td> </tr> <tr> <th>Pin number</th> <th>Signal</th> <th>Description</th> </tr> <tr> <td>1</td> <td>Vi+</td> <td>Power (12-24VDC±5%)</td> </tr> <tr> <td>2</td> <td>Vi-</td> <td>Power (GND)</td> </tr> <tr> <td>3</td> <td>FG</td> <td>Frame Grand</td> </tr> </tbody> </table>	Power connector	MC1,5/3-G-3,5 (Phoenix Contact)	12-24VDC Vi+  Vi-  FG 		Pin number	Signal	Description	1	Vi+	Power (12-24VDC±5%)	2	Vi-	Power (GND)	3	FG	Frame Grand
Power connector	MC1,5/3-G-3,5 (Phoenix Contact)																
12-24VDC Vi+  Vi-  FG 																	
Pin number	Signal	Description															
1	Vi+	Power (12-24VDC±5%)															
2	Vi-	Power (GND)															
3	FG	Frame Grand															

Checking the Network Addresses

The Ethernet (wired LAN), wireless LAN MAC address and IP address are defined on the housing sticker on the side of this product. Write down the MAC addresses for Ethernet and wireless LAN in the following table as they are device-individual values and may be required for future setup.

Table 2.6. Network Address

Description on the housing sticker	Explanation	Address
IP:	Default IP Address	
C:	Ethernet MAC Address	
W:	Wireless MAC Address	

Attaching the Antennas

Use this product with the antennas included. The following describes how to attach the supplied dipole antennas.

- (1) Straighten both the antennas, as shown below, and attach them to the antenna connectors on the main unit. The antennas screw onto the antenna connector. Adjust the position of the bending part of the antennas taking into consideration how the antennas will be oriented. Next, place the supplied rubber caps over the antennas and cover the antenna connectors.
- (2) Bend the antennas to the desired angles. The antennas can also be used straight. Change the angle as needed depending on the position of the unit.

< Example of vertical position >

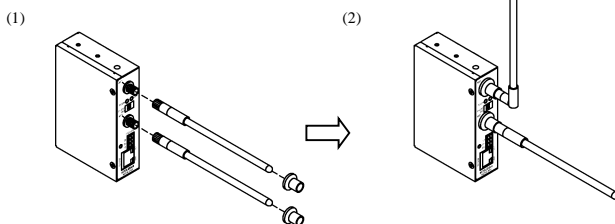

< Example of horizontal position >

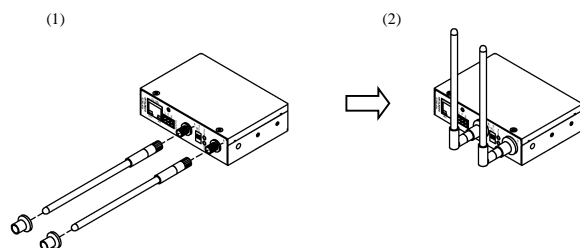

Figure 2.2. Attaching the Antennas

⚠ CAUTION

Using the product without connecting the antennas to the antenna connectors may cause the product to malfunction. Be sure to use the product with the antennas connected.

FCC PART15, R&TTE Directive, NCC Certification addenda (for USA, Europe, and Taiwan only)

The NZ2WL-US, NZ2WL-EU, and NZ2WL-TW comply with FCC PART15, the R&TTE Directive, and the NCC Certification when used under the following conditions.

- Attach ferrite cores to the power supply line and the FG line.

The following picture shows the ferrite cores attached to the cable.

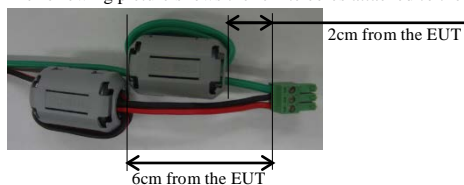

Attach ferrite cores to the FG line (2cm from the EUT) and the power supply line (6cm from the EUT), and turn the cable three times (wind it twice).

Power Supply

- The input voltage range of this product is 12 to 24 VDC $\pm 5\%$.
Using a power supply outside of that range may cause a malfunction or accident.
- Connect the cables correctly to the Vi+ (12 to 24 VDC $\pm 5\%$), Vi- (GND), and FG connectors.
- Use a power source that starts up within the input voltage range of 11.4 VDC or higher within 24 ms. Using a power supply that does not satisfy these conditions may cause a malfunction or accident.

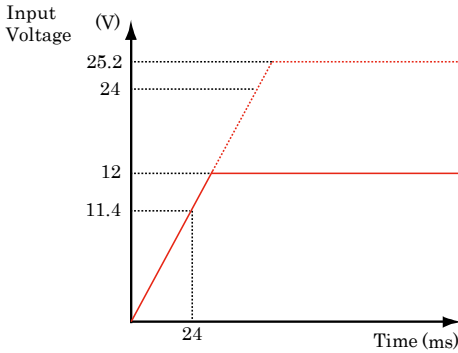

Figure 2.3. Power Supply Input Time

- The AC/DC power supply connected to the product must be CE-marked.
- Ground the FG terminal.
- Recommended power supply: PS5R-SF24 (made by IDEC Corporation)

Attaching a retention bracket

Plug in the power terminal connector to the power connector and attach the retention bracket using a bracket screw. The tightening torque of the bracket screw is 0.588 Nm.

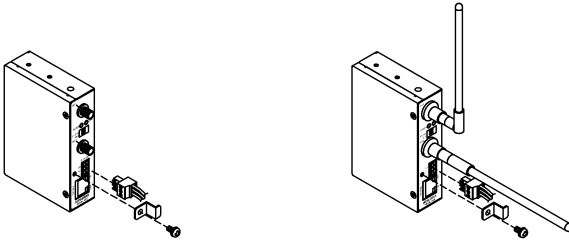

Figure 2.4. Attaching a Retention Bracket

Grounding the NZ2WL

Connect the cables to the applicable connectors. Process the cables as needed and ground the product.

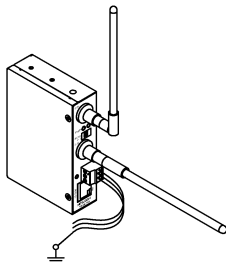

Figure 2.5. Grounding the NZ2WL

⚠ CAUTION

- The negative electrode (Vi-) terminal and the FG terminal of this product's power supply terminal are connected to the metal casing. Negative grounding is performed when the FG terminal is grounded or when the device to which the metal casing is attached is grounded, so use this product with negative grounding as shown in the wiring example in Figure 2.6. Performing positive grounding may short circuit the power supply, which may cause malfunction, heat generation, faults, or damage..
- As shown in Figure 2.7, never connect the negative electrode (Vi-) terminal of this product to the negative electrode of a periphery device whose periphery power supply has been positive grounded. Doing so may cause malfunction, heat generation, faults, or damage.

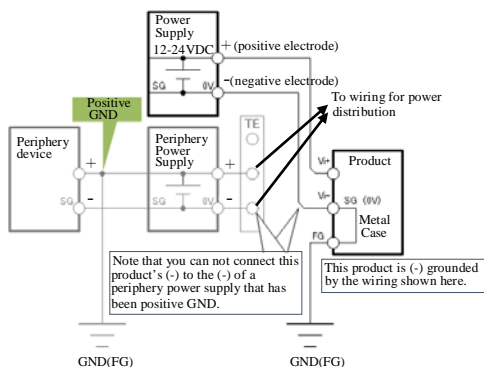

Figure 2.6. Example in power supply wiring

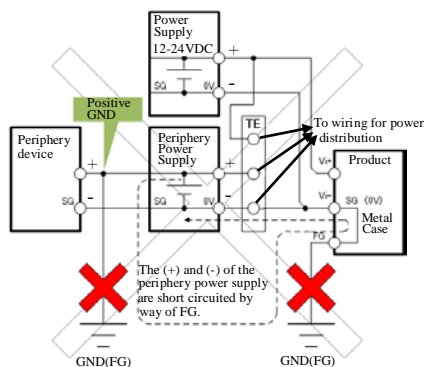

Figure 2.7. Example in which the periphery power supply is short circuited

Installation

Using Mounting Brackets

Mounting on a Desktop (Horizontally)

When the product is used horizontally, it can be mounted on a desk or other surfaces using brackets. Attach the product and brackets using the supplied bracket screws (tightening torque: 0.588 Nm), as shown below, and place the side with the brackets down. Then secure the brackets on the desk using tapping screws.

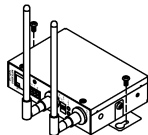

Figure 2.8. Mounting the Product on a Desk

Mounting on a Wall

The product can be mounted on a wall using mounting brackets. Attach the product and brackets using the supplied bracket screws (tightening torque: 0.588 Nm), as shown below, and then secure the brackets to the wall using tapping screws.

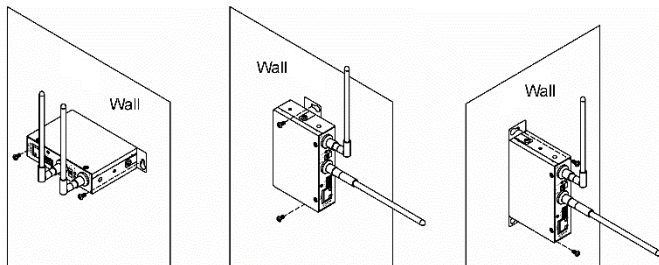

Figure 2.9. Mounting the Product on a Wall

⚠ CAUTION

When mounting the product on a desk or wall, place the product down with one of the orientations shown to the right.

When mounting the product vertically, orient the product with the LAN port on the bottom.

When mounting the product horizontally, orient the product with the WLAN LED on the bottom.

When mounting the product to a wall, secure the rear of the product or the side of the product closest to the WLAN LED to the wall. Place the product as indicated above when mounting it on the wall.

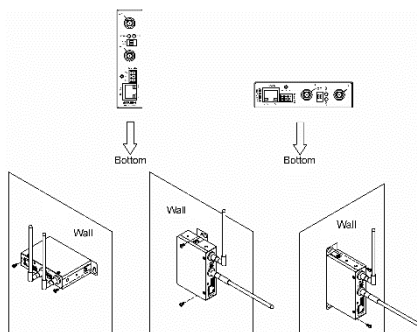

Wired LAN Connection

Connect the LAN cable to the LAN port on the product.

A cross cable is used to connect the product to the UP-LINK port of a PC or HUB. A straight cable is used to connect the product to the normal port of a HUB.

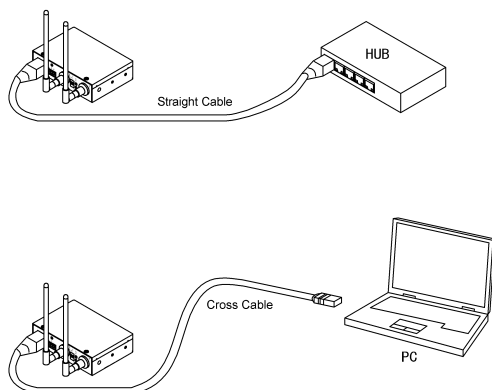

Figure 2.10. Wired LAN Connection

⚠ CAUTION

- The cable connecting the product to a hub, PC, or other device must not exceed 100 m.
- Use a CAT-5 or CAT-6 STP cable.
- This product cannot be used with IEEE 802.3af or other infrastructure that supplies power over an Ethernet cable (Power Over Ethernet (PoE)).

3. Connecting to Devices and Setup Methods

This product is set up via a network using a Web browser or TELNET. Follow the setup procedure below once the product is set up.

Setup Methods

Although the NZ2WL-xxx can be set up precisely to construct an advanced wireless LAN environment, there are two different setup methods available: web browser and TELNET.

Web browser

- Settings are easy with a graphical display and a help function.

TELNET

- This terminal setting uses TELNET.
- Only text is displayed, but settings are easy and quick.

Preparation before Setup

Since the product is set up via network, use a personal computer that can be connected to the network. Connect the personal computer to the network and use a Web browser or TELNET for setting.

Connecting the product for the first time

- (1) Connect this product to PC on a wired LAN.
- (2) Select an IP address 10.XXX.XXX.XXX (e.g. 10.0.0.1) for the PC, which is not the same address as for this product. And then set the subnet mask to 255.0.0.0.

Windows:

Click [Start] - [Control Panel] - [Network Connection], and then right-click the icon for local area connection to open up the [Properties] screen. Select [Internet Protocol (TCP/IP)] from the [General] tab and click [Properties]. Set up the IP address and subnet mask, and if necessary, default gateway and DNS server on the opened [Internet protocol (TCP/IP) properties] window.

Changing the settings

- (1) Connect this product to PC on a wired LAN.
- (2) Set the network address of the PC to the same network address as for this product.

Setup Using Web Browser

This section describes the setup method using a Web browser. The following Web browsers can be used (recommended Web browsers). Note that a proper display may not be shown on any browser other than the following ones.

Enable the JavaScript function in the browser setting as it is used.

Supported web browsers (recommended)

- Microsoft Internet Explorer 6 or later (7 or later recommended)
- Mozilla Firefox 1.0 or later (3.0 or later recommended)

Setting the Browser

You may have to change the browser settings as well as the IP address and subnet mask for the PC to be connected to this product via the network.

Changing browser settings

- (1) Networks at companies and schools may use browsers with proxy settings. Proxy is not required as a PC is used to set up the product, which is on a local network. Disable the proxy settings temporarily when setting up this product on a Web browser.

For information about how to disable proxy settings, refer to the help section of the Web browser used.

- (2) Enable JavaScript.

For information about how to enable JavaScript, refer to the help section of the Web browser used.



CAUTION

If the Web browser settings have been changed, restore the browser settings to the original settings after the setup of this product has been completed.

Connecting to This Product Using Web Browser

Start up a Web browser and enter the IP address of this product after “http : //” in the address bar.

If connecting to this product for the first time, enter the default IP address. When the default setting IP address is 10.144.0.1, enter as follows.

http://10.144.0.1/

Connecting to this product displays the “Access Point Manager” login window, shown below.

If the login screen is not displayed, the IP address setting for PC, browser settings, or the URL entered in the address bar of the browser may be incorrect.

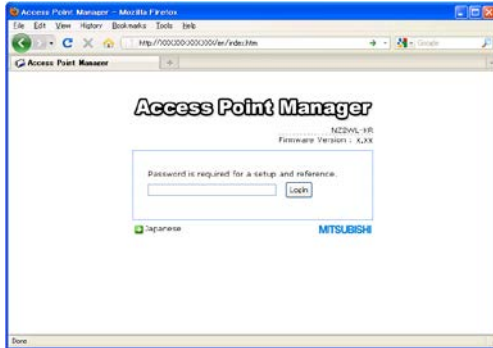

Figure 3.1. Login Window (KR)

Enter a password on the login window and click “Login” to log in.

When connecting to the product for the first time, do not enter any password and just click “Login” as no password has been set at the factory.

If the login is successful, the following setup window is displayed after a while.

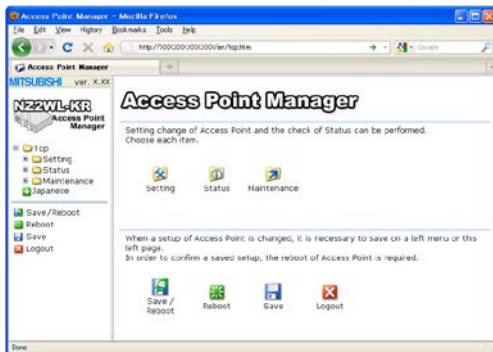

Figure 3.2. Window after Login (KR)

- Only the login window can be displayed before successful login. Before login, any attempts to access pages other than the login window result in "Login Error." Log in first to access the pages.
- Concurrent login is permitted for only one IP address. Attempting to log in while another user has already logged in from another IP address causes "Multiplex access prohibition error." Wait until the user logs out.
- Reload the browser when the screen corrupts.

Setup Using Web Browser

Select "Setting" in the left-hand menu ((1) in Figure 3.3) and further select the desired setting items from the opened menu. Information such as setting items will be displayed in the right-hand frame.

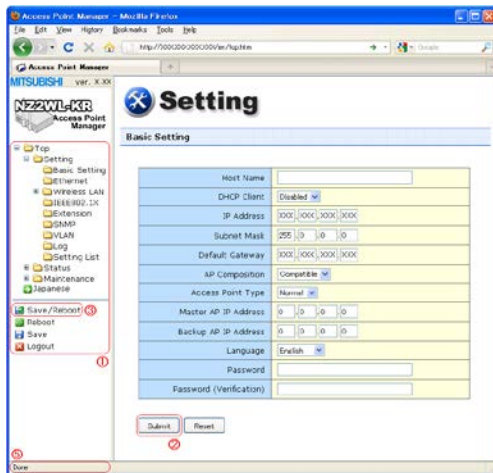

Figure 3.3. Setting by Access Point Manager (KR)

Click "Submit" ((2) in Figure 3.3) after changing settings on each page to temporarily save the settings in this product.

The settings become enabled when the product is restarted after all the setup procedure is completed and the settings are stored. Click "Save/Reboot" ((3) in Figure 3.3) on the left-hand menu.

The product can be rebooted later after the settings are saved, if necessary. In this case, saving the settings does not actually change the settings of the product. Therefore, make sure to reboot the product later.

"Time Out Error" will occur when there is no operation for approximately five minutes. The indicator (a bar drawn with ".") on the status bar ((5) in Figure 3.3) represents the approximate time for timeout^{*1}. The number of "." is gradually decreased and all "." disappear before timeout.

*1 The indicator may not be displayed according to the version and/or the setting of the browser. For details on setting item, please refer to "chapter 5 Setup and Status Display".

For details on setting items, please refer to "Chapter 5 Setup and Status Display".

⚠ CAUTION

It takes approximately 5 - 10 seconds to save settings (writing data to internal flash memory).

During that period, the POWER and WLAN LEDs at the front part of the main unit flash simultaneously. Do not reboot or turn off the product until the screen indicates the completion of the saving process.

The setup file data and firmware data may be damaged and the product may not operate properly if it is rebooted or switched off during the saving process.

After the operation is completed, click "Logout". Closing the window without logout may prevent login to other devices with other IP addresses and cause "Multiplex access prohibition error" on the devices. To log in the device where "Multiplex access prohibition error" occurred, wait until the user who currently logs in logs out or times out. Then try to log in again.

Setup Using TELNET

This section describes how to perform setup using TELNET. This procedure requires an application in which TELNET can be used. In Windows, "Command Prompt" can be used.

Connecting to the Product Using TELNET

Start up an application in which TELNET can be used (e.g. Command Prompt) and enter the IP address of this product after the telnet command*1. When connecting to this product using TELNET for the first time, enter the default IP address. For example, if the default IP address of the AP is [10.144.0.1], enter as follows.

```
telnet 10.144.0.1
```

The following login window is displayed when connected to this product.

If the login window is not displayed, the IP address setting for the personal computer may be incorrect.

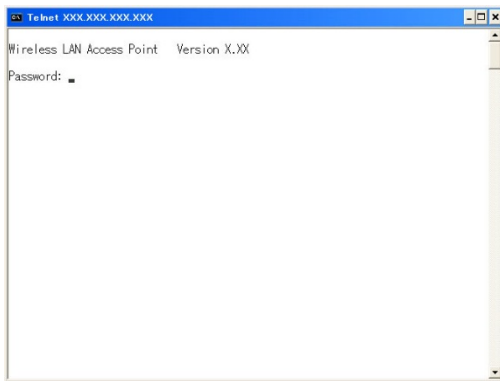

Figure 3.4. Login Window

Enter the password on the login window and press "Enter" to log in.

At the time of purchase, no password has been set up, so when connecting for the first time, just press "Enter".

*1 The telnet command may not be initially available depending on the versions of Windows. For how to enable the telnet command, refer to the Windows help screen.

If the login is successful, the following window is displayed after a while.



Figure 3.5. Window after TELNET Login



CAUTION

"Shift JIS" is used as the character code displayed during TELNET connection. Check the character code of the TELNET application if the characters become garbled.

Setup Using TELNET

After login, enter the number of the item shown in the top menu depending on the desired execution, and then press “Enter”. To perform configuration, enter “2” for “Configure”.

The items in the top menu are as follows.

Table 3.1. TOP Menu

Menu	Description
1. Exit	Exit terminal setup.
2. Configure	Selected to configure settings.
3. Write Configuration	Used to save the settings.
4. Reboot	Reboots the product. Reboot the product after changing the settings (after data write). The new settings become enabled after the reboot.
5. Update System Parameters	Changes the password or date.
6. Download	Downloads the setting file.
7. Upload	Sends the settings file from the connected personal computer (terminal) to the product and updates the settings.
8. Default	Restores the settings to the factory default settings. The IP address can be excluded.
9. Status	Used to check the setting details and the status after startup.

Each item also has further subdivided sub-items. Enter the number of the desired sub-item.

After selecting a setting sub-item, a value is required to be entered. Enter an appropriate value.

A list of the values which should be entered can be displayed by entering “H” or “?” when entering a value. When which value to enter is not clear, refer to “H or ?”.

TELNET Key Operation

Select items from the TELNET menus by entering the corresponding number. In addition to numbers, the following commands can be also used. The keys can be used in all the menus. Capital and small letters are not differentiated.

- TT Return to top menu
- E Escape from the current operation
- M Return to previous menu
- GO Jump to the specified category
- JP Change to Japanese mode (SHIFT-JIS)
- US Change to English mode
- W Save settings
- BYE / OFF End
- H or ? Display a list of commands (Help screen)



CAUTION

It takes approximately 5 - 10 seconds to save settings (writing to internal flash memory). During that period, the POWER and WLAN LEDs at the front part of the main unit flash simultaneously. Do not reboot or turn off the product until the screen indicates the completion of the saving process. The setup file data and firmware data may be damaged and the product may not operate properly if it is rebooted or switched off during the saving process.

4. Wireless Link Mode and Wireless LAN Function

This chapter describes the major functions of the NZ2WL series as a wireless LAN system and the wireless link modes of the product along with configuration examples of networks available in the wireless link modes.

Wireless Link Mode

This product has three wireless link modes. The available functions and network configurations differ depending on the mode. Use the wireless link mode most suitable to the type of network you are constructing. For details on the three modes, see "Features" in Chapter 1 and "Comparison of Main Functions" in this chapter.

The factory default setting is "Advanced Infrastructure Mode".

Chapters 3 and 5 describe the software setting procedures for the wireless link modes and related items.

Standard Infrastructure Mode

In this mode, each access point (AP) can accommodate stations (ST) to make up a network.

This mode allows the use of multiple APs to configure a wide-area wireless LAN. All communication between wireless terminals must go through an AP.

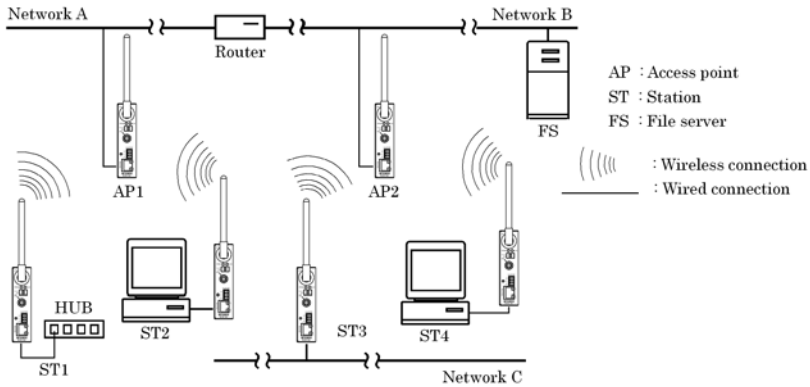

Figure 4.1. Standard Infrastructure Mode

In the Standard Infrastructure mode above, all wireless terminals communicate via AP. Roaming functions are supported, allowing login to any AP within range of radio waves.

For the IP tunneling function to work properly, one of the APs must be setup as a master AP.

* Normal AP: Normally operated device

Master AP: Device controlling access points in a network

Backup AP: Backup device that operates in case the master AP does not function for some reason

- Advantages
 - (1) If the IP tunneling function is used, communication can be performed over different routers without changing IP addresses.
 - (2) Allows log-in restrictions (security function).
 - (3) Improves security using the WSL (Wireless Security Link).

Compatible Infrastructure Mode

This mode allows the product to be networked with other manufacturers' Wi-Fi certified wireless terminals other than the NZ2WL series. Communications between the wireless terminals are always made via the APs.

⚠ CAUTION

The Compatible Infrastructure mode does not guarantee interconnection with Wi-Fi compliant products of other manufacturers.

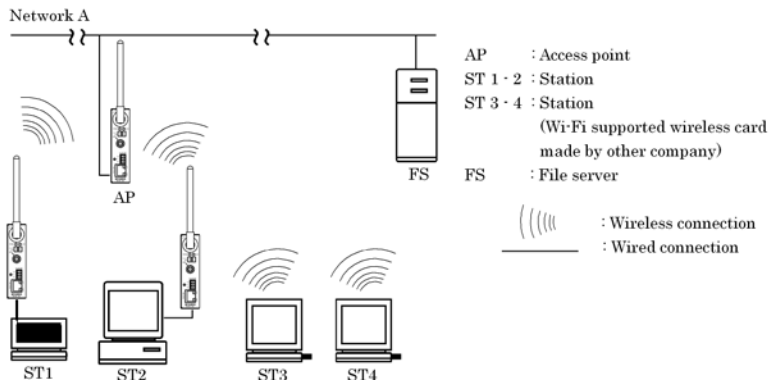

Figure 4.2. Compatible Infrastructure Mode

In the Compatible Infrastructure mode, each wireless terminal performs communication via the AP as in the Standard Infrastructure mode. Roaming functions are supported, allowing login to any AP within range of radio waves.

APs do not provide NZ2WL series' unique functions since APs work as a simple bridge.

Advanced Infrastructure Mode

The Advanced Infrastructure mode is a mixture of the Standard Infrastructure and Compatible Infrastructure modes. The Advanced Infrastructure mode can be used only when the product is configured as an access point.

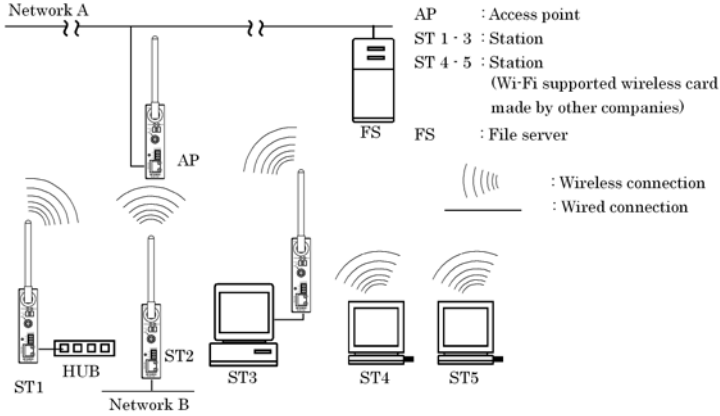

Figure 4.3. Advanced Infrastructure Mode

On the terminal set to the Standard Infrastructure mode, the NZ2WL series' unique functions can be used.

The terminal set to the Compatible Infrastructure mode serves as a simple bridge and thus the NZ2WL series' unique functions cannot be used on this terminal.

Comparison of Main Functions

The three wireless connection modes mentioned earlier have different wireless LAN functions. The following table lists main functions of each mode and gives a brief explanation of each function.

"○" indicates that the function can be used and "×" indicates that the function cannot be used.

Table 4.1. Comparison of Main Functions

Setting item	Standard Infrastructure mode	Compatible Infrastructure mode	Advanced Infrastructure mode *1
Roaming	○	○	○
IP tunnel	○	×	○*2
SNMP	○	○	○
Log collection function	○	○	○
MAC address filtering	○*3	○*3	○*3
Bridge packet control	○*3	○*3	○*3
Data encryption (WSL)	○	×	○*2
Data encryption (WEP)	○	○	○
Super A/G	○	○	○
VLAN function	○*3	○*3	○*3
WDS function	○*3	○*3	○*3
XR	○	○	○

*1 The Advanced Infrastructure mode can be used only when the product is configured as an access point.

*2 The functions cannot be used between an access point in the Advanced Infrastructure mode and devices set to the Compatible Infrastructure mode.

*3 MAC address filtering, bridge packet control, VLAN, and WDS are available only when the product is configured as an access point.

Roaming

The roaming function allows stations to switch logins between multiple APs. The roaming function can be used to construct a wide-area wireless LAN.

IP tunneling

With this function, the AP changes an IP address to allow a station to connect to a device in the desired network group via access point in the different network group. This function is unique to the NZ2WL series and cannot be used between an access point set to the Compatible Infrastructure mode and a station set to the Compatible Infrastructure mode.

SNMP

This function enables remote management using software that supports SNMP. This function can be used in all the modes.

Log collection function

This function collects event information such as a wireless communication of this product. For details, refer to Chapter 6.

MAC address filtering

This function can be used only when the product is configured as an access point. This function enables only the terminals whose MAC address has been registered to be connected.

Bridge packet control

This function can be used only when the product is configured as an access point. An AP can pass only data from network devices whose MAC address has been registered to the AP. Communication between wireless terminals can be rejected when their MAC addresses are unregistered.

WSL (Proprietary encryption)

WSL (Wireless Security Link) is unique proprietary encryption built only in the NZ2WL series of devices. It can be used either alone or along with other types of encryption such as WEP and AES. Note, however, that devices using WSL cannot communicate with those not using it.

Data encryption

This function encrypts wireless data. For encryption, four security protocols are available: WEP (Wired Equivalent Privacy), AES, AES-OCB and TKIP. AES and TKIP can be used with WPA, WPA-PSK, WPA2, WPA2-PSK, WPA-AUTO, and WAP-AUTO-PSK.

Super A/G

Proposed by Atheros Communications, Inc., this technology speeds up communication. It improves the throughput of wireless LAN using three techniques: "fast frames" for raising data transfer efficiency by increasing the data packet size, "bursting" for decreasing inter-packet wait time, and "compression" for compressing and decompressing data in real time.

VLAN function

This function can be used only when the product is configured as an access point. This function organizes terminals on a network into virtual groups regardless of the physical configuration of the network.

WDS function

This function can be used only when the product is configured as an access point. This function is a wireless communication function between APs. An AP can wirelessly communicate with other APs while communicating with a station.

XR

Promoted by Atheros Communications, Inc., this technology makes the communication distance longer, compared with the existing communication distance, although the communication speed decreases. XR can be used both in IEEE802.11a and IEEE802.11g specifications. For communication using XR, the product must be connected to a device which supports the XR technology and has the XR function enabled. If it is connected to any other device, XR will not be used and only the regular wireless communication is available.

Installation in a Network

This section describes how to install the product to construct a network with improved performance and discusses the general features of the wireless network and characteristics of radio waves, as well as the guidelines for constructing the network.

Features of the Wireless Network

In general, the operation of a wireless network is the same as for other similar types of LAN. The most prominent feature of the wireless network is that it uses radio waves as its medium, eliminating the need for cabling. The wireless network thus requires no cabling cost and has other advantages as listed below:

- Quick construction of a LAN
- Temporary installation of a LAN
- Higher flexibility in layout of connected PCs (terminals)
- Assured mobility of connected PCs (terminals)

On the other hand, the wireless network has the following drawbacks from the operational point of view due to the nature of radio waves :

- Signal attenuation
- Signal interference

Also, although this product does not require a radio license, it is subject to radio regulations of each country.

Operating Environment and Radio Waves

When using this product to construct a network, install and operate it considering the radio environment to optimize the performance.

Is it allowed to use wireless devices at the installation location?

In some medical institutions and laboratories, radio-sensitive precision instruments are used and it may be prohibited to use wireless devices.

Radio waves are attenuated.

Although a radio wave is attenuated naturally as it travels from its transmission source, it may also be attenuated by an object existing in its way. Major obstacles that attenuate radio waves are as follows:

- Concrete wall
- Metal surfaces in the vicinity of the antenna

Obstacles blocking radio waves include metal walls and walls containing a metal firewall.

Strictly speaking, nearly all objects in the path of the radio waves (such as partitions and people) cause some attenuation, but these do not have a significant impact on network performance.

RSSI (Receive Signal Strength Indication) utility is available as a means of knowing the signal strength of an incoming radio wave. Placing this product for a greater RSSI value makes the communication state more stable. If the RSSI value is small and does not increase by slightly moving the position of the product, it means that the radio waves may be being attenuated by distance or obstacles.

Pay attention to radio interference.

Radio interference means that radio waves in the frequency band used by this network occurred outside the network this product belongs to and that the reception of the radio waves is affected. Listed below are major examples of sources of interfering radio waves generated in general environments other than plants and factories:

- 5GHz (using IEEE802.11a) or 2.4GHz (using IEEE802.11b/IEEE802.11g) band wireless networks that do not comply with IEEE802.11
- Using IEEE802.11b/IEEE802.11g. (e.g. electronic devices that give off 2.4GHz band radio waves, such as microwave ovens, security gates installed near entrances of some shops, and copiers)

When there is a large metal wall such as in a warehouse, the radio wave generated from the sender is reflected, resulting in those radio waves reaching the receiver which have taken different routes (thereby phase-shifted). This has the similar effect as the generation of interfering radio waves, possibly slowing down data transfer.

Most of the interfering radio wave sources other than wireless networks have local and/or temporary effects, not giving great effect to the network performance. Rarely, however, communication speed is decreased and communication is disabled temporarily in the worst case. In such cases, changing the location of this product may solve the problem.

Constructing a Network

This section gives some pointers and cautions relating to constructing a network using the AP and station and provides some practical examples.

- (1) This product conforms with the standard wireless LAN specifications such as IEEE802.11a, IEEE802.11g and IEEE802.11b. This enables setting to the same channel as that used in each country and wireless communication between access points and stations responding to each channel. Using different channels for wireless networks adjacent to each other (In IEEE802.11a, set it to a channel such as 36 and 44 with 8ch or more apart, and in IEEE802.11g, a channel such as 1, 6, and 11 with 5ch or more apart) prevents radio interference and improves the throughput of the networks.

- (2) Check the range of radio waves (hereinafter collectively called "cover area"). To use the AP with two or more station logged in AP, all the stations must be installed within the cover area. The AP's coverage varies with obstacles (concrete walls, iron doors, elevator halls, etc.). Note also that the number of transmission/reception errors increases if communication distance becomes longer to some extent.

When setting up the network, check the RSSI level then confirm that communication works correctly with the application you plan to use. For a TCP/IP system, for example, you can use the Windows PING command. To use PING, start the command prompt (MS-DOS) and enter the following command. The example command is for an AP with an IP address of 10.144.0.1, as follows.

```
ping 10.144.0.1
```

- (3) Two or more stations can log in the AP at the same time. However, remember that the communication speed slows due to the increased loading as the number of stations increases for one AP.
- (4) If a pair of wireless terminals are communicating via a particular channel, no other devices can communicate within the range of those radio waves (the exception is broadcasting which transmits to all terminals). As a result, communication speed tends to drop as the density of wireless terminals increases although this depends to a large extent on how frequently the network is used.
- (5) If the AP is connected to an Ethernet hub or similar, an unexpectedly large load can occur on the AP if the Ethernet traffic is heavy and this may reduce the performance of the wireless network. This can be solved by changing the hub connected to the AP to a switching hub (bridge).
- (6) Setup the software in accordance with how the network will be used.
- (7) The communication speed may also drop due to interference if two wireless terminals are located close to each other. In general, maintain a gap of about 1m between stations, 3m between APs and stations, and 3m between APs.
- (8) The best performance is achieved from antennas if they are located in an open space free from obstructions. Avoid locating antennas where they will be hidden. In particular, when communication distance is an important consideration, it is recommended that you install antennas in a high location with a clear view.
- (9) Floors often contain steel beams or metal firewalls and therefore communication on different floors is often not possible.

5. Setup and Status Display

This chapter explains about setting items and status displays of this product. Always read Chapter 2 “Setup” and Chapter 3 “Connection to Devices and Setup Methods” for preparation before performing setup or viewing the status. At the time of purchase, this product is configured as an access point.

This section describes how to setup this product and status displays using a web browser.

Settings

◆ Basic setting

■ Host Name

Enter the host name of the product using 31 or less alphanumeric characters. Assigning a name to this product allows easy identification on the network.

Factory default setting: (Not input)

■ DHCP Client

Enabling “DHCP client” makes this product available as a DHCP client.

Factory default setting: Disable

■ IP Address

Specify the IP address of the product. Make sure to perform this setting when not enabling the DHCP client. When setting via a LAN using a browser running on a PC, the network address of the product must be the same as the network address of the PC.

Factory default setting: (Specified on the housing sticker)

■ Subnet Mask

If using a subnet, specify the subnet mask.

If DHCP Client is set to "Enable", you can skip this setting.

Factory default setting: 255.0.0.0

■ Default Gateway

Specify the IP address of the router for the network to which the product belongs.

If DHCP Client is set to "Enable", you can skip this setting.

Factory default setting: 0.0.0.0

■ AP Composition

Sets the access point composition. Select "Compatible".

Normally, you do not have to change the default setting.

Factory default setting: Compatible

■ Access Point Type

The application type of the access point can be set by selecting “normal”, “master”, or “backup”. The “master” device integrates access points on the network and the “backup” device substitutes for the master AP if the master AP stops working for some reason.

As a basic rule, select “master”. You can also select “master” when the product is configured as a station. Normally, you do not have to change the default setting.

Factory default setting: Normal

■ Master AP IP Address

Specify the IP address of the wireless LAN device that serves as the master.

Factory default setting: 0.0.0.0

■ Backup AP IP Address

When the wireless LAN device for backup exists, specify its IP address.

Factory default setting: 0.0.0.0

■ Language

Select either “Japanese” or “English” for the WEB setup screen and TELNET setup display language.

Factory default setting: English

■ Password

Set a password. Enter a string of up to 31 alphanumeric characters. The password is case sensitive.

If you forget your password, initialize the product using the DIP switch (INIT).

The password is cleared when the product is initialized. Note, however, that initializing the product resets all of its settings to their factory defaults, requiring you to make settings over again.

Factory default setting: (Not input)

◆ Ethernet

■ Port Speed

Select the port speed setting. Select one of "Auto", "100M Full Duplex", "100M half Duplex", "10M Full Duplex", or "10M half Duplex".

Factory default setting: Auto

⚠ CAUTION

- If one side is set to "Auto" and the other side is set to "100M Full Duplex", the communication mode for the "Auto" side is recognized as "100M half Duplex". In this case, there may be a high error rate and normal communication may not be possible. It is recommended that you set the correct communication mode.
 - If one side or both sides are set to "Auto" and the two sides cannot recognize each other, set the communication mode to the unchanging setting for both sides.
 - If port speeds are set incorrectly (for example, one side is set to unchanging 10M and the other side is set to unchanging 100M), only one device may be able to establish a link or the link may be repeatedly established and disconnected depending on the communication status. In this case, set the correct communication mode.
-

■ Link Down Sense

Enabling the link down sense feature stops the wireless function when a link is regarded to be down in the wired LAN at an access point.

The condition for detecting the link down-state is selected as a link-down condition: "Link status" or "Ping". "Link status" sets the condition to "when a physical link is disconnected at the wired LAN port of the product". "Ping" issues a ping packet periodically to a specified communication destination and sets the condition to "when a reply error occurs".

Factory default setting: Wireless LAN ... Disable
Link Down Condition ... LinkStatus

■ Ping Parameter

These parameters are used when "Ping" is selected as the link-down condition.

Specify the IP address of the destination to which to periodically send a ping packet. Be sure to specify a valid IP address of the other device connected to the wired LAN. Specify the transmission interval (in seconds) of a ping packet issued. Enter a value between 1 and 65535.

Specify the response wait time (in seconds) for which to wait for a reply to a ping. Enter a value between 1 and 15. Specify the retry count for when there is no response to a ping packet issued. Enter a value between 0 and 15.

Factory default setting: IP Address ... 0.0.0.0
Interval Time (s) ... 60
Reply Waiting Time (s) ... 3
Retry Count ... 3

◆ Wireless LAN

To change the wireless LAN standard, wireless connection mode, take three steps of “Basic” -> “Details” -> “Security” to make their respective settings.

For any other item, you can change the setting on under “Details” or “Security”.

▼ Basic

■ Interface

Disabling “Interface” disables the internal wireless LAN module.

When switching from “Disable” to “Enable”, options such as channels do not appear in the “STEP 2 Details” setup as the built-in wireless LAN module function is suspended until this product is rebooted. When you come to STEP 2, select “Save/Reboot” in the menu on the left hand side of the Web browser to save the settings and reboot the product.

Factory default setting: Enable

■ Wireless LAN Standard

Set the wireless LAN standard to be used.

When the unit type is "Access point", select one of the check boxes.

When the unit type is "Station", you can select more than one check box. In this case, the wireless LAN standard is set automatically from among the set wireless LAN standards, according to the destination access point. However, if the wireless LAN standard of the access point is not included among wireless LAN standards set for the station, a connection to that access point cannot be established.

Factory default setting: IEEE802.11a and IEEE802.11g

■ Wireless Link Mode

Select the operation mode of the product from among “Standard Infrastructure”, “Compatible Infrastructure”, and “Advanced Infrastructure (AP only)”.

Factory default setting: Advanced Infrastructure

Table 5.1. Wireless Link Mode

Wireless link mode	Outline
Standard Infrastructure	Each access point can accommodate stations (such as wireless LAN cards) to make up a network. This mode provides scalability from a middle- or large-scale system with multiple access points connected by LAN to a small-scale system based on a single access point.
Compatible Infrastructure	This mode allows the product to be networked with other manufacturers' Wi-Fi certified wireless terminals other than the NZ2WL series.
Advanced Infrastructure (AP only)	The access point can be used in both of the Standard Infrastructure and Compatible Infrastructure modes. This mode is a mixture of the two.

■ Unit Type

Select either “Access point” or “Station”.

Factory default setting: Access point

Table 5.2. Unit type

Unit type	Overview
Access point	Master access point controlling other stations or access points operating in station mode.
Station	Access points controlled by (logged into) another access point. For use when using as a bridge, for example.

■ XR function

To enable the XR (eXtended Range) function, set to “set to “Enable”.

When the XR function is enabled, the transmission rate is fixed to “Automatic”.

Factory default setting: Disable

▼ Details

■ ESSID

The name of the wireless LAN to which the AP belongs. Enter a name within 32 alphanumeric characters. The name is case sensitive.

When the unit type is "Station", set ESSID same as the access point which wants to log in.

Factory default setting: LocalGroup

■ Channel

This item is available when the unit type is “Access point”. Select the wireless channel to use. Select from among the available channels for the country where used. The following are the available channels.

Factory default setting: (depends on the country where used)

Table 5.3. Country channels

Standard	Channel*1				
	U.S.A. (NZ2WL-US)	Europe (NZ2WL-EU)	China (NZ2WL- CN)	Korea (NZ2WL-KR)	Taiwan (NZ2WL- TW)
IEEE802.11a	36, 40, 44, 48, 149, 153, 157, 161, 165ch	36, 40, 44, 48ch	149, 153, 157, 161, 165ch	36, 40, 44, 149, 153, 157, 161ch	149, 153, 157, 161, 165ch
IEEE802.11b/g	1-11ch	1-13ch	1-13ch	1-13ch	1-11ch

*1 The channels of this product can be changed only among the same models.

■Transmission Rate *1

Sets the wireless transmission rate.

Select one from "Auto", "54Mbps", "48Mbps", "36Mbps", "24Mbps", "18Mbps", "12 Mbps", "9 Mbps", "6 Mbps" for IEEE802.11a.

Select one from "Auto", "11Mbps", "5.5Mbps", "2Mbps", "1Mbps" when IEEE802.11b.

Select one from "Auto", "54Mbps", "48Mbps", "36Mbps", "24Mbps", "18Mbps", "12 Mbps", "9 Mbps", "6 Mbps", "11Mbps", "5.5Mbps", "2Mbps", "1Mbps" for IEEE802.11g.

You can use "Max." to set the maximum transmission rate. Specify the maximum transmission rate when the transmission rate is "Auto". For example, when the maximum transmission rate is "36Mbps", an optimal transmission rate at or below 36 Mbps is used. You can use "Max." to set the maximum transmission rate, but normally, you set "Transmission Rate" to the maximum value. You can set the maximum transmission rate to any of the above transmission rates except "Auto".

*1 These are theoretical values based on their respective wireless LAN standards; they do not indicate actual data transfer rates

Factory default setting: Auto, (Max.) 54Mbps

■Beacon Transmission Rate

Sets the wireless transmission rate. Specify the beacon transmission rate. The options available to this item are the same as those for the above transmission rate except "Auto". Normally, this does not need to be changed.

Factory default setting: 6Mbps

■Basic Rate

This item is available when the wireless LAN standard is either "IEEE802.11g" or "IEEE802.11b" and the unit type is "Access point". This sets the basic rate. Specify the basic rate which is the transmission rate for control communication between access point and station. Normally, this does not need to be changed from the default setting.

When the wireless LAN standard is "IEEE802.11g" and the 11g Only mode is "disabled," either "IEEE 802.11" or "IEEE802.11b" can be selected. When the wireless LAN standard is "IEEE802.11g" and the 11g Only mode is "enabled," either "IEEE802.11g" or "OFDM" can be selected.

When the wireless LAN standard is "IEEE802.11b," either "IEEE802.11" or "IEEE802.11b" can be selected.

Factory default setting: No item

■TX Power Level

You can decrease the transmission output to "50%" or "25%" by software setting. To decrease the output, select either "50%" or "25%".

Factory default setting: MAX

■ Super A/G

This item sets the Super A/G feature for increasing the communication speed of wireless LAN. To use Super A/G, enable the feature. Of the Super A/G feature, enable "Frame bursting" to use the frame bursting function and enable "Real-time compression" to use the compression function.

To enable the Super A/G feature, usually, enable "Frame bursting". As real-time compression has no effect on already compressed data (such as ZIP and jpeg files), enable or disable the function selectively depending on the application of communication.

Factory default setting:	Function	... Disable
	Frame bursting	... Enable
	Real-time compression	... Enable

■ 802.11g Parameter

This item is available when "IEEE802.11g" is selected as the wireless LAN standard. Parameter about IEEE802.11g can be set.

Enabling the "802.11g Only" mode rejects access from IEEE802.11b compliant station and accepts access only from IEEE802.11g compliant station, resulting in communication with IEEE802.11g station at higher data rates than when both types of station coexist with the "802.11g Only" mode disabled. This item available when the unit type is "Access point".

Enabling the protect mode enables stable communication even in an environment in which IEEE802.11b-compliant products coexist with IEEE802.11g compliant station. Disabling the protect mode makes communication a bit unstable but increases the communication speed to some extent.

For the protect type, specify the data packet configuration method. "CTS-only" uses only CTS to transmit and receive data. "RTS-CTS" uses both RTS and CTS to transmit and receive data. Communication speed of "CTS-only" is faster than that of "RTS-CTS". This setting is enabled when the protect mode is enabled. Normally, select "CTS-only".

Factory default setting:	802.11g Only mode	... Disable
	Protect mode	... Enable
	Protect type	... CTS-only

■ Antenna Select

Specify the antenna to use. When set to "Auto", a diversity configuration with two external dipole antennas is used. Select "1" when using only one antenna so as to disable the diversity configuration or to connect using only one external antenna. Selecting "1" uses ANT1 and selecting "2" uses ANT2, but when using only one antenna, it is recommended that "1" be selected for reasons related to the characteristics of the product.

Factory default setting: Auto

■ Multi Client Function

This item is available when the wireless link mode is "Compatible Infrastructure" and the unit type is "Station". Select "Enable" to enable the multi-client function that allows connection to more than one PC, when the product is configured as a station.

Factory default setting: Disable

■Statistic Node Address

This item is available when the wireless link mode is "Compatible Infrastructure", the unit type is "Station", and the multi-client function is "Disable". Enter the MAC addresses of the PCs connected to the product. Generally, set this item when connected to a receive-only device, such as a POS terminal.

Enter the MAC address "00-00-00-00-00-00", which consists of nothing but 0, meaning the function is disabled, when not using the function.

When specifying a MAC address, enter a hyphen (-) at intervals of two characters.

(Example: 01-23-45-67-89-ab)

Factory default setting: 00-00-00-00-00-00

■Maximum Number of Stations to Log In

This item available when the unit type is "Access point". The number of stations to log in AP is limited. Enter a value between 1 and 254.

Normally, the maximum number is 254 units, but it varies depending on the encryption function of the wireless LAN in use.

The maximum number is 124 units when using IEEE 802.1X encryption.

The maximum number is 128 units when using AES-based WPA/WPA2/WPA-AUTO or WPA-PSK/WPA2-PSK/WPA-AUTO-PSK encryption.

The maximum number is 32 units when using TKIP-based WPA/WPA2/WPA-AUTO or WPA-PSK/WPA2-PSK/WPA-AUTO-PSK encryption.

Factory default setting: 254

Table 5.4. Maximum Login

Encryption	Units
Encryptions other than those described below	254
IEEE802.1X	124
AES (when using WPA function)	128
TKIP (when using WPA function)	32

■Roaming Threshold

This item is available when the unit type is "Station". When the RSSI value of the currently connected access point is smaller than the setting value, the product searches for a roaming-accessible access point and roams into that access point if possible. Threshold can be set from 0 to 95. Increasing this value makes roaming easier and decreasing it makes roaming harder.

Factory default setting: IEEE802.11a/g ... 24

IEEE802.11b ... 24

■ Priority AP

This item available when the unit type is “Station”. This item allows you to specify the access point to be connected preferentially. Enter the wireless MAC addresses of the access points in AP1 to AP5. Wireless MAC addresses of access points can be checked on “Status” for each access point and “Wireless MAC address” of the “Wireless LAN”.

The access points to be connected are assigned priorities in ascending order beginning with AP1 (followed by AP2, ..., AP5). Entering wireless MAC addresses enables this function. To disable this function, enter zeroes (00-00-00-00-00-00) for all MAC addresses.

When specifying a MAC address, enter a hyphen (-) at intervals of two characters.
(Example: 01-23-45-67-89-ab)

If the product is unable to connect to any of the access points AP1 to AP5, set "Connect to other APs" to "Enable" to allow a connection to other access points. To prevent the product from connecting to access points other than the prioritized access points, set "Connect to other APs" to "Disable".

Factory default setting: AP1 - AP5 ... 00-00-00-00-00-00
Connect to other APs ... Enable

■ Communication distance

Extending the ACK time-out interval prevents ACK time-out from occurring during long-distance communication. Select "Less than 1 km", "1 - 10 km", "10-20 km", or "Over 20 km". This item adjusts the ACK time-out interval and each option is a guide setting of the time-out interval. It does not increase transmission output or antenna gain to expand the communication distance. Normally, this does not need to be changed from the default setting.

Factory default setting: Less than 1 km

■ Load Balance

Load balancing is the function used to prevent wireless terminals from flocking to one access point upon connection. When the load balance function is set to “Enable” and the unit type is "Access point", notification of the number of stations logged in is sent and the stations are connected to the access point with fewer connections preferentially. When the unit type is "Station", a connection is established to the access point with fewer connections preferentially.

Set the RSSI threshold of the connected access points to the load balance threshold. When the product is roaming or connecting to an access point, a connection is established to the access point with an RSSI value higher than the setting value and with the fewest possible logged in connections. Enter a value between 0 and 95. The load balance threshold must exceed the roaming threshold. This item is available when the unit type is "Station".

To use this function, the access points and stations must be NZ2WL Series products and must have the load balance function enabled.

Factory default setting: Function ... Disable
Load balance threshold ... 30

■ Beacon Interval

This item is available when the unit type is “Access point”. Specify the transmission interval at which the access point transmits a beacon signal. Enter a value between 20 and 1000 in milliseconds (ms). Normally, this does not need to be changed.

Factory default setting: 100 (ms)

■DTIM

This item is available when the unit type is "Access point". Set the interval at which to add a DTIM (Delivery Traffic Indication Message) to a beacon signal, which is information for recovering a station from power-save mode. Enter a value between 1 and 255.

Setting this item to 1 adds a DTIM to each beacon signal and setting it to 2 adds one to every other beacon signal.

Factory default setting: 1 (time)

■QoS

This function preferentially sends a specific packet, such as VoIP.

This can be used, for example, to provide the optimal environment for an internal IP phone system using wireless LAN.

To enable the QoS function, set it to "Enable".

Factory default setting: Disable

■WDS

This item is available when the unit type is "Access point". To enable the WDS function, set it to "Enable". In that case, you must specify the wireless MAC addresses of the remote APs with which to communicate. Use the "Edit List" button to open another window for setup and set the MAC address.

You can register up to six wireless MAC addresses for inter-AP communication.

When specifying a MAC address, enter a hyphen (-) at intervals of two characters.

(Example: 01-23-45-67-89-ab)

The types of encryption available for wireless LAN setup are WEP, AES, and AES-OCB. WPA cannot be used. In addition, the IEEE 802.1X function cannot be used in conjunction.

The WDS function cannot be used when channel 56, 60 or 64 has been selected for IEEE 802.11a. Use a different channel.

Factory default setting: Disable

Encryption that can be used is WEP, AES (WPA no such), and AES-OCB only. WPA functions can not be used. In addition, it can not be mixed with IEEE802.1X function.

■Power-save Mode

This item is available when the unit type is "Station". To enable power-save mode, set it to "Enable".

Enabling power-save mode can reduce power consumption of wireless devices. This is effective when operating on battery power, but it reduces performance, so it is recommended that normally this be set to "Disable".

Factory default setting: Disable

■ Scan Channels

This item is available when you choose the channel to scan. Selecting the "Scan Channels" might shorten the scan time and make a roaming smoothly. Enter each channel with the ",". (Example: 36, 40, 48 to scan the channels of 36, 40, 48 only...) If you want to scan all of the channels that support, leave it blank. Normally, you do not have to change the default setting.

Factory default setting: (Blank)

■ AP Aging Time (s)

Specify the time to hold the information of the access point in the "Wireless node information". If you want to change from the factory default setting, please perform sufficient validation on the system you want to use. Normally, you do not have to change the default setting. Enter a value between 10 and 120.

Factory default setting: 120 (seconds)

■ Original Login Trial Time (s)

This item is available when the wireless link mode is "Standard Infrastructure". Specify the time to try the "Original Login" when the "Standard Infrastructure" is selected. If you want to change from the factory default setting, please perform sufficient validation on the system you want to use. Normally, you do not have to change the default setting. Enter a value between 3 and 60.

Factory default setting: 60 (seconds)

■ Disconnect Time (s)

If you have lost a beacon while connecting to the access point or failed to connect to another access point, you can specify the time until it is cut. If you want to change from the factory default setting, please perform sufficient validation on the system you want to use. Normally, you do not have to change the default setting. Enter a value between 1 and 10.

Factory default setting: 10 (seconds)

■ IP Tunnel

This item is available when the wireless link mode is "Standard Infrastructure". When connected to the access point of the IP address of the device and another segment (IP tunnel state), if you have to "Enable", discard the broadcasts from different segments received by the wireless LAN without a bridge to a wired LAN side. If you are on the "Disable", then bridge a broadcast from another segment. If the IP address in the "Standard Infrastructure" is not the state of the IP tunnel connected to the access point of another segment, please to "Disable". And, if the IP address to connect to the access point of the same segment, you do not need to change the setting.

Factory default setting: Enable

■ Roaming Notification Retry Count

This item is available when the wireless link mode is "Standard Infrastructure". It will specify the number of times to retransmit the roaming notification packet of the connected equipment under the wired LAN. This setting is enabled when "IEEE802.1x", "WPA", "WPA-PSK", "WPA2", "WPA2-PSK". Retransmission interval is 1 second. Enter a value between 0 and 3.

Factory default setting: 1

▼Security

■Encryption

This setting specifies whether to enable or disable encryption. You can select a type of encryption from among "WEP", "AES", "AES-OCB", and "TKIP". If you select "AES" or "TKIP", one of the WPA functions described later can be used. When "TKIP" is selected, use one of the WPA functions. If you disable encryption, neither key can be used as the default key.

Factory default setting: Disable

Table 5.5. Wireless Link Mode

Encryption	WPA Function	Setup
WEP	x	WPA cannot be used. Set one of the keys #1 to #4 for use.
AES	O	Select whether or not to use WPA. You do not have to set key #1 to #4 when WPA is used.
AES-OCB	x	WPA cannot be used. Set one of the keys #1 to #4 for use.
TKIP	O	WPA must be used. You do not have to set key #1 to #4.

■WPA function

Specify the authentication type when WPA is used. This item can be set only when encryption has been set to "AES" or "TKIP".

The available authentication types are "WPA", "WPA-PSK", "WPA2", "WPA2-PSK", "WPA-AUTO", and "WPA-AUTO-PSK".

"WPA-AUTO" and "WPA-AUTO-PSK" are modes combining WPA (-PSK) and WPA2 (-PSK). When these modes are used, it is determined whether each station uses WPA (-PSK) or WPA2 (-PSK) and communication is performed according to the authentication type of each station.

To use IEEE 802.1X authentication-based WPA, select "WPA", "WPA2" or "WPA-AUTO" and set up IEEE 802.1X.

To use WPA without an authentication server, select "WPA-PSK", "WPA2-PSK", or "WPA-AUTO-PSK", and set the WPA encryption key described below.

When encryption is "AES", you can select "Disable". WPA is not used at this time. When encryption is "TKIP", you cannot select "Disable". Select an item other than "Disable".

"WPA-AUTO" and "WPA-AUTO-PSK" are available only when the unit type is "Access point". These items cannot be set when the unit type is "Station".

Factory default setting: Disable

■Default Key

Set this item when encryption has been set to "WEP", "AES", or "AES-OCB" and the WPA function is disabled. Select the key number to be used, from among keys #1 to #4.

Factory default setting: #1

■ Size / Key #1 - #4

Set this item when encryption has been set to "WEP", "AES", or "AES-OCB" and the WPA function is disabled. Specify the size and value of the key to be used for encryption. The acceptable size and number of digits of the key depend on each type of encryption. Enter the key in hexadecimal (0 - 9, a - f, or A - F).

Factory default setting: (No input)

Table 5.6. Number of Key Input Digits

Encryption	Size and No. of Input Digits	
WEP	64bit	10
	128bit	26
	152bit	32
AES	128bit	32
AES-OCB	128bit	32

■ Key Update Time (minutes)

This item available when the unit type is "Access point". Set this when WPA is enabled. Set the update time of the broadcast key (group key) in minutes. Specify the key update interval between 0 and 65535 in minutes. Setting it to 0 stops key transmission.

Factory default setting: 60 (minutes)

■ WPA Encryption Key

Set this item when the WPA function has been set to WPA-PSK/WPA2-PSK/WPA-AUTO-PSK. Enter a WPA encryption key (Pre-Shared Key) using 8 to 63 alphanumeric characters.

Factory default setting: (No input)

■ WSL (Wireless Security Link)

This item is available when the wireless link mode is "Standard Infrastructure" and "Advanced Infrastructure (AP only)".

Select whether to enable or disable proprietary encryption (WSL) for wireless data. Note, however, that WSL-enabled and WSL-disabled terminals cannot communicate with each other.

There are two types of WSL: Type 1 using an earlier version of the encryption algorithm and Type 2 using the latest version. When the wireless LAN standard is "IEEE802.11a", only Type 2 can be used. When it is "IEEE802.11b" or "IEEE802.11g", either Type 1 or Type 2 can be selected. Select the right type according to application.

The WSL key setting takes effect only when the WSL function is enabled. Note that terminals with different WSL keys cannot communicate with each other.

Enter the WSL key using a string of 20 hexadecimal digits (0 - 9, a - f, or A - F). (Example: 0123456789abcdef0123)

Factory default setting: (No input)

■ ESSID security

This item is available when the unit type is "Access point". ESSID security is the composite function as the combination of "ANY ID reject" and "ESSID hide". Enabling this function rejects access by ANY

ID terminals (those with no ESSID assigned) and hides the AP's ESSID from external references to the access point. Using the function restricts illegal access using ANY ID and prevents the ESSID from being easily known to third parties.

Factory default setting: Disable

■MAC address filtering

This item is available when the unit type is "Access point". Select whether to use the MAC address filtering function. Enabling the function rejects access by stations other than those stations with an authorized MAC address. All network devices connected to the stations over Ethernet are permitted / prohibited as a whole. To edit authorized MAC addresses, click the "Edit List" button to open the window for setting MAC address filtering.

On the setting window of MAC address filtering, authorized MAC addresses can be added and deleted. To add one MAC address, enter the MAC address in "Starting address" and click the "Add" button. To add a series of consecutive MAC addresses, enter the first MAC address in "Starting address" and the last MAC address in "Ending address", and then click the "Add" button. To delete a MAC address, click the "Delete" button to the right of the MAC address to be deleted in the list of authorized MAC addresses.

When specifying a MAC address, enter a hyphen (-) at intervals of two characters.
(Example: 01-23-45-67-89-ab)

Add the wireless MAC address of the station to the list when;

- the wireless link mode of the station is "Standard Infrastructure."

or

- the wireless link mode of the station is "Compatible Infrastructure" and "Multi client function" is enabled on the station. Wireless MAC address of Station can be confirmed by using "Status" of each Station and "Wireless MAC address" of the "Wireless LAN" items.

Add the MAC address of the network device connected with the station when the wireless link mode of the station is "Compatible Infrastructure" and "Multi client function" is NOT enabled on the station.

Factory default setting: Disable

◆ IEEE802.1X

■ IEEE802.1X

Set this item to "Enable" to enable the function of IEEE802.1X.

When the IEEE 802.1X function is "Enable" and WPA/WPA2/WPA-AUTO is not used, be sure to select "WEP" for the wireless LAN security setting to enable key exchange.

This function is not available when the unit type is "Station", so select "Disable".

Factory default setting: Disable

■ MAC Address Authentication Function

To enable the MAC address authentication function, set it to "Enable".

Factory default setting: Disable

■ Reauthentication Interval (minutes)

Specify the interval at which to perform reauthentication. Specify a value between 2 and 4320 (minutes).

Factory default setting: 60 (minutes)

■ WPA Reauthentication

Specify whether to periodically perform RADIUS server reauthentication when "WPA", "WPA2", or "WPA-AUTO" is selected for "WPA Function".

When this is "Enable", reauthentication is performed at the time set in "WPA Reauthentication Interval (minutes)".

Factory default setting: Disable

■ WPA Reauthentication Interval (minutes)

When "WPA Reauthentication" is enabled, set the interval in minutes at which to perform RADIUS server reauthentication. Specify a value between 2 and 4320 (minutes).

Factory default setting: 1440 (minutes)

■ (RADIUS server) IP address

Enter the IP address of the RADIUS server.

Factory default setting: 0.0.0.0

■ (RADIUS server) Port number

Enter the port number used for communication with the RADIUS server.

Factory default setting: 1812

■ (RADIUS server) ESSID

When switching to the RADIUS server specified in "IP address" above, the ESSID of the access point changes to the ESSID set here. Set this item only when using this function. Leave this item blank when you do not need to use this function.

Factory default setting: (No input)

■(RADIUS server) Pre-shared Key

Enter the pre-shared key of the RADIUS server.

Factory default setting: (No input)

◆Extension**■Bridge Packet Control**

This item is available when the unit type is "Access point". Enabling bridge packet control prevents file sharing among clients under the same access point. To create a network that permits file sharing, use "Edit List" to open a separate window and then register the MAC address of the router or device for which file sharing is permitted.

When specifying a MAC address, enter a hyphen (-) at intervals of two characters.

(Example: 01-23-45-67-89-ab)

Register the wireless MAC address of the station when the wireless link mode of the station is "Compatible Infrastructure" and "Multi client function" is enabled on the station. When multiple devices are connected to the station, shared files are permitted / prohibited as a whole. Wireless MAC address of Station can be confirmed by using "Status" of each Station and "Wireless MAC address" of the "Wireless LAN" items.

Otherwise, register the MAC address(es) of the network device(s) connected to the station. Shared files are permitted / prohibited for each device.

Factory default setting: Disable

■ Network Time

Enabling the network time function can synchronize the access point time with the network time.

To enable this function, set the IP address and time zone of a network time server on the network.

(Example: For use in Japan, enter “+09 : 00” (meaning UTC + 9 hours) as the Japan standard time is nine hours ahead of Universal Time Coordinated (UTC).)

Factory default setting: Function ... Disable

IP Address ... 0.0.0.0

Time Zone ... +09 : 00

■ Access Control

Set the access control for this product. Disabling TELNET, FTP, WEB server function rejects the connection to each server. Note that if disabling all the settings, the product cannot be accessed for setup.

Enabling specification of administrator IP, you can specify the IP address to connect to TELNET, FTP, WEB. Up to two administrator IP addresses can be registered in “Administrator IP address 1” and “Administrator IP address 2”.

When using this function, you need to enable server functions such as TELNET. Note that if only disabled IP addresses are registered, the connection to the product using the TELNET, FTP, and WEB cannot be made.

When the "Wireless Access" is set to "Disable", the connection from a wirelessly connected station to the product using the TELNET, FTP and WEB is rejected. When the setting is "Enable", connections from a wirelessly connected station are permitted.

Factory default setting: TELNET / FTP / WEB Server ... Enable

Administrator IP Address ... Disable

Administrator IP Address 1 - 2 ... 0.0.0.0

Wireless Access ... Enable

■ Network Delay Time (s)

Specify the maximum delay time acceptable to the network.

When an access point communicates with the server or another access point, a communication time-out may occur if an intermediary line is slow in communication speed. If this is the case, increase the network delay time to prevent a time-out from occurring.

Enter a value between 0 and 15.

Normally, you do not have to change the default setting.

Factory default setting: 0 (seconds)

■ Encryption Config File

When this is “Enable”, the setup files (CONFIG) are encrypted and saved to the internal memory when the settings are saved.

Whether setup file encryption is “Disable” or “Enable”, both encrypted and unencrypted setup files can be used when those files are written to this product by file transfer.

The password set in this product (up to 31 alphanumeric characters) is used as the password for the encryption.

Factory default setting: Disable

■ Protocol Filter

When this is "Enable" and a filter is registered, specific protocol (such as TCP and UDP) packets can be blocked or allowed.

To edit a filter, click the "Edit List" button to open the window for setting the protocol filter list, and then edit the filter. Set the following settings in the window for setting the protocol filter list, and then click the "Add" button to register the filter to the list.

Table 5.7. Protocol filter setting

Setting Item	Setting Method
Operation	Select whether to allow or block specified packets.
Ethernet type	Specify the Ethernet frame type to "IP (0x0800)", "ARP (0x0806)", "RARP (0x8035)" or "802.3 (0x0 to 0x05DC)", or specify a user-defined type other than an IEEE 802.3 Length Field. When specifying a user-defined value, enter a value between 0x05dd and 0xffff (1501 to 65535). When registering a hexadecimal value, start with "0x". When registering a decimal value, enter the value as is. You can define only one individual value and one range.
IP protocol	Enter this when "IP" is selected as the Ethernet type. You can specify the protocol number included in the IP header. You can specify "All (0 - 255)", "TCP (6)", "UDP (17)" or "ICMP (1)" or specify a user-defined protocol number. When specifying a user-defined value, enter a value between 0 and 255 (0x0 to 0xff). When registering a decimal value, enter the value as is. When registering a hexadecimal value, start with "0x". You can define only one individual value and one range.
Port number	Enter this when "TCP" or "UDP" is selected as the IP protocol. You can specify the TCP or UDP port number. Specify "All (0 - 65535)" or "User defined". When specifying a user-defined value, enter a value between 0 and 65535 (0x0 to 0xffff). When registering a decimal value, enter the value as is. When registering a hexadecimal value, start with "0x". You can define only one individual value and one range.

The registered filter is displayed in the table below the input form.

To delete a registered filter, click the "Delete" button for that filter. Clicking the "All" button on the table deletes all filters.

Specify "Allow" or "Block" for the action of protocols whose action has not been specified in the protocol filter list. When specifying "Block", be sure to register those protocols that are required for use of this product to the filter as "Allow". Note that communication to this product is allowed even if "Block" is specified, so the setting can be changed later.

Factory default setting: Function ... Disable
Operation of unspecified protocols ... Allow

■ Roaming Notification

Roaming notification packets are packets that notify other access points and switching hubs that a station has moved when station roaming has occurred.

When the "Send notification packets" setting is "Enable", notification packets are sent when station roaming occurs.

"First login notification" is a setting that is enabled for access points whose wireless link mode is "Standard Infrastructure". Use this to set whether to send notification packets at first login after a connected station is started.

"Notification packet bridge" sets whether to bridge notification packets to a separate interface when notification packets are received.

Normally, you do not have to change the default settings of the roaming notification settings.

Factory default setting: Send notification packets ... Enable
First login notification ... Enable
Notification packet bridge ... Enable

■ Delete System Files (INIT-SW)

This sets whether to delete certificates and other system files when initializing the system with the INIT switch.

To restore only the settings and password to the default values, select "Disable". To delete system files as well, select "Enable".

Factory default setting: Disable

■ CPU Power-save Mode

Operating this product's CPU in power-save mode can reduce power consumption. This is effective when operating on battery power, but it reduces performance, so it is recommended that normally this be set to "Disable". To enable CPU power-save mode, set it to "Enable".

Factory default setting: Disable

◆ SNMP

■ SNMP Agent

Set this item to "enable" to enable SNMP.

Factory default setting: Disable

■Community Name

Enter the SNMP authentication string. The SNMP authentication string serves as a password to access this product using SNMP. Programs use this community name to access MIB of this product. *1

Enter a string of up to 32 alphanumeric characters. The community name is case sensitive.

Factory default setting: public

*1 Management Information Base: complies with RFC1213 and RFC1493

■Access Right

Set the access right for the community. Select “Read/Write” or “Read Only”.

Factory default setting: Read / Write

■Trap IP Address

Trap is the function to notify a user of a change made within the SNMP agent system. The trap function can be enabled by specifying the IP address of the destination user. The SNMP manager having the IP address specified here can manage trap information of this product.

If the network contains more than one AP, it is advisable to register the same IP address so that all the APs can be managed on one machine. If the network contains more than one wireless terminal, it is advisable to register the same IP address so that all the wireless terminals can be managed on one machine. Up to three destinations IPs can be registered.

Factory default setting: 0.0.0.0

■sysContact

Enter contact information of the administrator of this product. An example is the name and telephone number of the network administrator. The string can be up to 32 alphanumeric characters.

Factory default setting: (No input)

■sysLocation

Specify the physical location of this product. An example is “Administration Division, 2F”. The string can be up to 32 alphanumeric characters.

Factory default setting: (No input)

■sysName

Specify the device name of this product under SNMP. Enter a string of up to 32 alphanumeric characters. The sysName is case sensitive.

Factory default setting: (No input)

■Trap

When the trap function is enabled, a trap is transmitted when the Ethernet or wireless LAN link status changes (goes down). This can be set separately between Ethernet and wireless LAN.

Factory default setting: Ethernet ... Disable
Wireless LAN ... Disable

◆ VLAN

■ VLAN

This item is available when the unit type is "Access point". Set this item to "Enable" to enable the VLAN function.

Factory default setting: Disable.

■ VLAN ID

This item is available when the unit type is "Access point". Specify the VLAN ID of this product between 1 and 4094.

Factory default setting: 1

■ Guest Access

This item is available when the unit type is "Access point". Select whether to permit the guests in the guest VLAN ID group other than the VLAN ID groups registered in the VLAN table to access the station. To enable guest access, set this item to "Enable".

Factory default setting: Enable.

■ Guest VLAN ID

This item is available when the unit type is "Access point". Set this item if you set guest access to "Enable." Set the VLAN ID for each guest to a value between 1 and 4094. Guest VLAN IDs must be different from any VLAN ID in any other VLAN group registered in the VLAN table.

Factory default setting: 1

■ RADIUS server

This item is available when the unit type is "Access point" and the IEEE 802.1X function or MAC address authentication function is "Enable". Specify the RADIUS server for use with guest VLAN. The displayed number refers to the number of the RADIUS server with IEEE802.1X selected. Select the RADIUS server number for connections to be allowed.

Factory default setting: (All selected)

■ VLAN table

This item is available when the unit type is "Access point". Set a VLAN group. You can set up to 16 VLAN groups. Use "Edit List" to open the VLAN group setup window to set VLAN groups. Enter the ESSID and VLAN ID for each VLAN group. The ESSID and VLAN ID must be different from those of any other VLAN group or any guest VLAN group.

If WEP (without use of IEEE 802.1X), AES-OCB, or AES not used for WPA is selected for encryption during wireless LAN setup, the encryption setting for each VLAN group can be changed. In this case, the encryption setting is displayed, allowing you to set the encryption key for each VLAN group. You can also change the key size when using WEP.

The RADIUS server to be used by each VLAN group can be specified when the IEEE 802.1X or MAC address authentication function is enabled. The displayed number refers to the number of the RADIUS server with IEEE802.1X selected. Select the RADIUS server number for connections to be allowed.

This allows you to specify a different RADIUS server for each VLAN group.

Factory default setting: (Not setup)

Some of the notes to the VLAN function, there are limitations.

If you want to guest connection, you can use the wireless LAN settings that you set in the "wireless LAN" above.

Encryption of the wireless LAN setting, when you use the WPA or WPA-PSK, can not add a VLAN group to the VLAN table.

ESSID and VLAN ID of the VLAN group to be added to the VLAN table do not overlap with other groups.

If you enable the VLAN function, data to be handled in the wired LAN interface will be only the frame with a VLAN tag.

It can not be used in conjunction with WDS.

◆ Log

The product can preserve log information. See Chapter 6 "Maintenance" for details of the logged data and data collection methods.

■ Log

This specifies whether or not to enable logging. Set the function to "Enable" to collect logs.

Factory default setting: Disable

■ File Save

To save collected log information as a file, enable the function. To store it temporarily in the memory, disable the function. "Temporarily" here means the period in which the device is running. Log information will be deleted if this product is rebooted or switched off when the function is "Disable".

Factory default setting: Disable

■ Overwrite Mode

This specifies whether or not to overwrite old data when the number of log entries reaches the maximum. If disabled, log collection is suspended when the maximum number of entries is reached.

Factory default setting: Enable

■ Debug Log

To record the debug information in the log, enable the function. If you do not want to record it, disable the function. Debug Log is the log to investigate if a communications failure occurs in the wireless LAN. Normally, select "Disable".

Factory default setting: Disable

■ Starting Day/Time Setting Function

To specify the date and time to start logging, set it to "Enable".

Factory default setting: Disable

■ Starting Day/Time

When the starting day/time function is enabled, specify when logging should be started. Enter four digits for the year. (Example: 2010 Jan. 1 00:00)

Factory default setting: 2002 Jan. 1 00:00

■ Detailed Setting

You can select the types of events to be logged. Setting [Login], [Logout], [Login NG], [Roaming], [Tunnel Start], [Tunnel Stop], [Application Login], [Application Logout], [Auth Success / Error] and [Date / Time Set] to “ON” allows the selected events to be logged. Setting them to “OFF” prevents them from being logged. See Table 5.8 for a description of the types of events.

Factory default setting: All "ON"

Status Display

A list of status information on this product can be displayed by selecting “Status” after logging in through a web browser or TELNET.

This displays the following information.

■ Basic Information

- Loader Version

Displays the version of this product's loader.

- Firmware Version

Displays the version of this product's firmware.

- Hardware Version

Displays the version of this product's hardware (circuit board).

- Ethernet Address

Displays the wired LAN (Ethernet) MAC address of the access point.

- Wireless MAC Address

Displays the MAC address of the wireless LAN card.

- IP Address

Displays the IP address of the access point.

- Subnet Mask

Displays the subnet mask set for the access point. The subnet mask is the mask value used when obtaining the network address of the subnet from the IP address. The subnet value can be obtained from the logical OR of the mask value and the IP address.

- Default Gateway

The gateway is a device that provides a relay between different networks. This displays the IP address of the standard connected gateway.

- Country Identification Code

Displays the country identification code of this product.

■ Interfaces**- MTU**

The maximum transmission unit (MTU) is the maximum length of data that can be transmitted in one transmission. This displays the MTU for each interface.

- Transfer Speed

Displays the data transfer speed for each interface.

- MAC Address

Displays the MAC address for each interface.

- Interface / Link Status

Displays whether each interface is active and connected to the network.

- RX Octets

Displays the number of data bytes received by the access point.

- RX Unicast Packets

Unicast is the transmission of data to a specific destination in the network by specifying a single address. This displays the number of unicast packets received by the access point.

- RX Broadcast Packets

Broadcast is the transmission of data to multiple unspecified destinations in the network. This displays the number of broadcast packets received by the access point.

- RX Discards

When data is damaged for some reason, those data packets are discarded. This displays the number of times data that have been discarded.

- RX Errors

Displays the number of errors that occurred when receiving data.

- RX Errors (CRC)

CRC (Cyclic Redundancy Check): Displays the number of errors detected during a CRC.

- TX Octets

Displays the number of data bytes transmitted by the access point.

- TX Unicast Packets

Displays the number of unicast packets transmitted by the access point.

- TX Broadcast Packets

Displays the number of broadcast packets transmitted by the access point.

- TX Wait Count

Displays the number of times waiting that occurred for data transmission when transmitting data.

- TX errors

Displays the number of errors that occurred when transmitting data.

- Reset Count

Displays the number of resets that occurred in an interface.

■ Wireless LAN information

- Wireless LAN Standard

Displays the currently operating wireless LAN standard.

- Wireless Link Mode

Displays the currently operating wireless LAN mode: Standard Infrastructure, Compatible Infrastructure, or Advanced Infrastructure.

- Unit Type

Displays the current wireless LAN type: Access point or Station.

- Module ID

Displays the ID of the wireless device incorporated in this product.

- Wireless MAC address

Displays the MAC address of the wireless LAN card.

- Login AP

When the unit type is "Station", this displays the wireless MAC addresses of the access points logged in to this product.

- ESSID

Displays the ESSID set for this product.

- Channel

Displays the wireless LAN channel used by this product.

- Transmission Rate

Displays the transmission rate (in Mbps) at which data is currently being transmitted.

- Receive Rate

Displays the transmission rate (in Mbps) at which data is currently being received.

- Number of login

When the unit type is "Access point", this displays the number of stations logged in to this product.

- RSSI

When the unit type is "Access point", this displays the received signal strength indication (RSSI) of the unit, which is a measurement of the strength of the signal being received.

■ Wireless Statics Information**- Transmit Unicast Packets**

Displays the total number of unicast packets transmitted by the wireless interface of this product.

- Transmit Multicast Packets

Displays the total number of multicast packets transmitted by the wireless interface of this product.

- Transmit Unicast Bytes

Displays the total number of unicast bytes transmitted by the wireless interface of this product.

- Transmit Multicast Bytes

Displays the total number of multicast bytes transmitted by the wireless interface of this product.

- Transmit Retry (Single) Packets

Displays the number of times that packets have been retransmitted one time, due to reasons such as wireless LAN transmission error.

- Transmit Retry (Multiple) Packets

Displays the number of times that packets have been retransmitted multiple times, due to reasons such as transmission error from the wireless interface of this product.

- Number of Transmit FIFO Underruns

Displays the number of FIFO underruns that occurred when transmitting data.

- Receive Unicast Packets

Displays the total number of unicast packets received by the wireless interface of this product.

- Receive Multicast Packets

Displays the total number of multicast packets received by the wireless interface of this product.

- Receive Unicast Bytes

Displays the total number of unicast bytes received by the wireless interface of this product.

- Receive Multicast Bytes

Displays the total number of multicast bytes received by the wireless interface of this product.

- Receive FIFO Overruns

Displays the number of FIFO overruns that occurred when receiving data.

- Receive Hardware FCS Errors

Displays the number of FCS errors that occurred with the hardware.

■ Wireless node information

- Wireless MAC Address

When the unit type is "Access point", this displays the MAC address of the wireless LAN card. When the unit type is "Station", this displays the MAC addresses of the access points located near this product.

- Mode

Displays the wireless LAN standard (802.11a/b/g) being used by the device(s) where the MAC address is displayed.

- RSSI

When the unit type is "Access point", this displays the RSSI of stations logged in to this product. When the unit type is "Station", this displays the RSSI of the detected access points.

RSSI is a measurement in numerical terms of the strength of the signal being received by the product.

- Transmission Rate

When the unit type is "Access point", this displays the transmission rate of stations logged in to this product. When the unit type is "Station", this item is not displayed.

- Receive Rate

When the unit type is "Access point", this displays the reception rate of stations logged in to this product. When the unit type is "Station", this item is not displayed.

- Aging Time

When the unit type is "Access point", this displays the aging time (time on the network) of stations logged in to this product. As the duration that the station is not connected continues, the aging time decreases proportionally. When a connection is established, this item returns to the default value (300 seconds). When the aging time reaches 0, the node information for that station is deleted from the table. When the unit type is "Station", this item is not displayed.

- ESSID

When the unit type is "Station", this displays the ESSID of the detected access points. When the unit type is "Access point", this item is not displayed.

■ MAC Address Table**- MAC Address**

Displays the MAC addresses of external devices obtained when this product connects to the devices.

- Interfaces

Displays the interfaces of the product that obtained the MAC addresses of external devices.

- Aging Time

Displays the aging time (time on the network) of external devices displayed by MAC address. As the duration that the external device is not connected continues, the aging time decreases proportionally. When a connection is established, this item returns to the default value (300 seconds). When the aging time reaches 0, the MAC address for that external device is deleted from the MAC address table.

- Wireless MAC Address

When an external device is a wireless LAN device communicated via wireless LAN, this displays the wireless MAC address of that external device.

- Flag

When connected normally, "Normal" is displayed. When connected via IP tunnel, "Tunnel" is displayed.

■ Log Information

Log information recorded in this product is displayed. To clear log information, click “Clear log information”.

For main events displayed on the logs and their outlines, see the table below.

Table 5.8. Events to Be Logged

Event	Description
Start	Indicates that the AP has been activated.
Link Up	Indicates that the wired link has been connected and the link speed.
Link Down	Indicates that the wired link has been disconnected.
Login	Indicates the MAC address of the wireless terminal connected to the AP.
Logout	Indicates the MAC address of the wireless terminal disconnected from the AP.
Login NG	Indicates that the filter function rejected an attempt to log in by an unregistered wireless terminal.
Roaming	Indicates the MAC address of the wireless terminal roaming into the AP.
Tunnel Start	Indicates the MAC address of the wireless terminal that has started IP tunneling.
Tunnel Stop	Indicates the MAC address of the wireless terminal that has terminated IP tunneling.
Application Login	Indicates the IP address of the terminal that has used an application (such as TELNET and FTP).
Application Logout	Indicates the termination of an application and the IP address of the terminal that used the application.
Write Firmware	Not available on this product.
Write Config	Indicates that the Config file has been written.
Manual Reset	Indicates that this product has been restarted using a web browser, TELNET, and other methods.
Auth Success	Successful authentication
Auth Error	Authentication error
Preauth Success	Successful preauthentication
Preauth Error	Preauthentication error

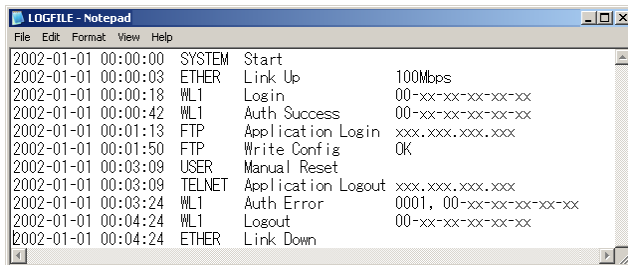

Figure 5.1. Simplified Log Display

6. Maintenance

This chapter describes how to perform maintenance on this product and explains the tools to be used. Here, “maintenance” means the following: log file collection and saving and restoring the software settings.

This product does not support firmware updates.

Maintenance Tool

The FTP can be used for maintenance of this product. This section explains about maintenance methods using the FTP.

Log File Collection

Log files can be collected by using the FTP via LAN.

The log file is in text format and can be displayed in the Notepad or WordPad programs that come with Windows.

The collected log file is stored with the following file name in the memory of this product.

File name: LOGFILE



CAUTION

To collect log files, the log function must be enabled. Note also that the contents of the log files differ depending on the software settings.

Collecting Log Files Using FTP

Follow the instructions below to collect log files using the FTP.

- (1) Move to the folder where the file should be stored.
- (2) Run the FTP to log in to this product.
- (3) Transfer the log file.
- (4) Exit the FTP.

The following is an example of when Windows Command Prompt (MS-DOS Prompt) is used.

In this example, the file will be moved to the saving folder D:\tmp and LOGFILE will be collected after connecting to this product using FTP. The example assumes the IP address as 10.144.0.1.

```
C:\>cd D:\tmp ----- (1)
D:\tmp>ftp 10.144.0.1 ----- (2)
ftp>get LOGFILE ----- (3)
ftp>bye ----- (4)
```

Saving a Setting File

Saving a software setting file of this product has the following benefits:

- If you have more than one product and all the products should have the same settings, setting is required only for one product. The setting file can be used for the remaining products. (As this sets the same IP address for all the products, change the IP address for each product in advance.)
- The old settings can be restored easily if a fault causes the settings file to be erased.

The setting file is stored with the following file name in the memory of this product.

File name: CONFIG

If the MAC address filtering is used, its setting file should also be saved. The setting file is stored with the following name in the memory of this product.

MAC address filtering ... MACFLIST

The file is in the memory even when the MAC address filtering function is not in use. It, however, does not have to be saved.

Note that files of BRGFLIST and LOGFLIST may be stored in the memory of this product, but it is not used as a setting file.

The setting file is saved by collecting the CONFIG file (MACFLIST file if needed) stored in the memory.

Saving Setting File Using FTP

Follow the instructions below to save a setting file using the FTP.

- (1) Move to the folder where the file should be stored.
- (2) Run the FTP to log in to this product.
- (3) Transfer the setting file (CONFIG).

Transfer MACFLIST if necessary.

- (4) Exit the FTP.

The following is an example of when Windows Command Prompt (MS-DOS Prompt) is used.

In this example, the file will be moved to the saving folder D: \tmp and CONFIG and MACFLIST will be collected after connecting to the product using FTP. The example assumes the IP address as 10.144.0.1.

```
C:\>cd D:\tmp ----- (1)
D:\tmp>ftp 10.144.0.1 ----- (2)
ftp>get CONFIG ----- (3)
ftp>get MACFLIST
ftp>bye ----- (4)
```

Restoring the Software Settings

The software settings of this product can be recovered by using the saved setting file.

The setting file is restored by storing the previously collected CONFIG file (MACFLIST file if needed) in the memory.

Restore Settings Using FTP

Follow the instructions below to restore software settings using the FTP.

- (1) Move to the folder where the file is stored.
- (2) Run the FTP to log in to this product.
- (3) Transfer the setting file (CONFIG).
Transfer MACFLIST if necessary.
- (4) Issue the reset request command (command: quote crst).
- (5) Exit the FTP.

The following is an example of when Windows Command Prompt (MS-DOS Prompt) is used.

In this example, the file will be moved to the folder with file D:\tmp and CONFIG and MACFLIST will be transferred after connecting to the product using FTP. The example assumes the IP address as 10.144.0.1.

```
C:\>cd D:\tmp ----- (1)
D:\tmp>ftp 10.144.0.1 ----- (2)
ftp>put CONFIG ----- (3)
ftp>put MACFLIST
ftp>quote crst ----- (4)
ftp>bye ----- (5)
```

The reset request command shown in (4) is a command used to reboot the product. There is no problem to skip (4), exit the FTP in (5), and reboot the product later.

Time Setting

Set the time on this product. Enter the year (4 digits), month, day, time (24-hour notation), minute, and second, and then click the [Update] button. If you enter one digit for the month or day, a zero will be added to display the month or day in two digits. You can enter either one digit or two digits with an added zero. (Example: 2010/8/12 13:06:01)

Clicking the [Set PC Time] button copies the time of the internal clock of the PC with the browser opened to the input form.

Initialization

There are three ways to initialize this product (recovering the factory default settings).

- Using TELNET
- Using a web browser
- Using the DIP switch of the main unit (INIT)

Each initialization method is described below.

Using TELNET

Follow the instructions below to initialize the product using TELNET.

- (1) Use TELNET to log in to this product.
- (2) In the main menu, select "8. Default".
- (3) Enter "Y" for the question "Load default setting? (Y/N)"
- (4) For the question "Load default IP address? (Y/N)", enter "Y" to initialize the IP address as well or "N" to leave it unchanged.
- (5) From the main menu, select "4. Reboot" - "1. Cold boot", and then enter "Y" for the question "Save the setting? (Y/N)". Then reboot the product.

Saving the setting and rebooting the product after loading the default setting initializes the product.

If the default setting is loaded by mistake, select "1. Exit" from the main menu and enter "N" for the question "Save the setting? (Y/N)" without rebooting the product. This allows the setting to be unchanged and terminated.

Using a Web Browser

Follow the instructions below to initialize the product using a web browser.

- (1) Use a web browser to log in to this product.
- (2) Select “Maintenance” - “Default setting” from the menu.
- (3) To leave the IP address of the product unchanged without initialization, tick “Do not set IP address to default”. To initialize the IP address, tick “Set IP address to default” and then click “Default”.
- (4) Click “Save/Reboot” on the menu to save the default setting to reboot the product.

Saving the setting and rebooting the product in the step (4) initializes the product.

If the default setting is selected by mistake, click “Logout” on the menu to close the Web setup screen.

Using the DIP Switch (INIT)

Follow the instructions below to initialize the product using the DIP switch (INIT) of the main unit.

- (1) Turn on switch 1 of the DIP switches (left switch, INIT) at the front part of the main unit.
- (2) Immediately after that, the POWER LED and WLAN LED flash for approximately three seconds. Turn off DIP switch 1 during the flashing.
- (3) Wait for a while until the flashing of the POWER LED and WLAN LED stops and then reboot the product (power on/off).

Rebooting (3) initializes the product.

The POWER LED and WLAN LED continue to flash for a little while after DIP switch 1 is turned off. Turning off the product during the flashing may damage the file in the memory and cause improper operation of the product. Reboot the product after the flashing stops.

7. Troubleshooting

This chapter describes common problems that may occur with this product and what to do about them. If a problem not described here occurs or the same problem occurs after checking the nature of the problem, contact your local authorized dealer.

When Communication Fails

■ Check wired LAN communication

Check the wired LAN communication between this product and the connected PC.

- Check that the LAN cable is connected correctly.
- Check if the IP addresses and subnet masks of the product and PC are set correctly. (See "Preparation before Setup" in Chapter 3.)
- To connect the product to a PC directly, a cross cable must be used. Check to see if a straight cable is used instead for the connection. (See "Wired LAN Connection" in Chapter 2.)
- When the product is connected to a PC through a HUB, the cable connecting this product and the HUB must be selected depending on the HUB port. Check if the correct cable is used for the connection. If the HUB port supports AUTO-MDIX, either a straight or cross cable can be used. For the UPLINK port, a cross cable must be used to connect the product.
- The communication with this product is not possible unless the TCP/IP protocol is installed in the PC.

■ Check wireless LAN communication

If no problem is detected in the wired LAN communication between the product and PC, check the wireless LAN communication between the product and access point.

- The terminals that cannot communicate with each other may have different ESSIDs. Two terminals with different ESSIDs cannot communicate with each other.
- Check whether the wireless link mode has been set correctly. The AP to be logged in to and the product must have the same wireless connection mode. (If the access point is set to "Standard Infrastructure", this product should also be set to "Standard Infrastructure".)
- Check whether communication is restricted by security functions such as the MAC address filtering.
- Check whether the data encryption setting is the same as that of the recipient. Communication cannot be performed between devices with different types of encryption.

■ Check the peripheral environment and place of installation

- A nearby source of electromagnetic interference may prevent communication. In general locations (excluding factories) the following may be sources of electromagnetic emissions.
 - 5GHz band not conforming to IEEE802.11 (when using IEEE802.11a) or 2.4GHz band (when using IEEE802.11b/IEEE802.11g) wireless network
 - Electronic devices that give off 2.4GHz band radio waves, such as microwave ovens, security gates installed near entrances of some shops, and copiers, when using IEEE802.11b/IEEE802.11g

Most electromagnetic sources other than wireless networks are local and not continuous. Moving the location of the product and waiting for a while may enable communication.

- Sometimes communication is hindered by attenuation of radio waves. Attenuation occurs naturally as distance from the source of transmission increases, but may also be caused by objects in the path of the transmission. The objects primarily responsible for attenuation are the following.
 - Concrete walls
 - Metallic surfaces around this product

Setup Screen Unavailable on Web Browser

- Check if communication is possible between the product and PC.
- If no problem is detected in the communication between the product and PC, it may be related to the browser settings. For the browser settings, see Chapter 3 “Connection to Devices and Setup Methods”.

When the Product Does Not Start

■ Check the power LED

- Check whether the “POWER” LED is ON. If it is not ON, check the power supply cable and confirm that it is properly connected to the proper connector and outlet.
- Check whether the Power LED is flashing. If the power LED still flashes for more than 5 minutes after the power is switched on, the firmware of the product may be in failure. Contact your local authorized dealer.

■ Check the power

- When power is supplied using the proper connector, check the power supply connection and the voltage for any problems. See "Chapter 2. Setup" for details of the power supply connections.

8. Appendix

BShardware Setup

Switch 1: OFF

Switch 2: OFF



Figure 8.1. DIP Switch

Initial Setting

Table 8.1. Initial Setting List < 1 / 5 >

Item		Default setting
Basic setting		
Host name		(No input)
DHCP Client		Disable, enable
IP address		(Displayed on the housing sticker on the main unit)
Subnet mask		255.0.0.0
Default gateway		0.0.0.0
AP construction		Compatibility, integration
AP type		Normal, master, back up
IP address of the master AP		0.0.0.0
IP address of the backup AP		0.0.0.0
Language setting		English, Japanese
Password		(No input)
Ethernet		
Port speed		Auto, 100M/full-duplex, 100M/half-duplex, 10M/full-duplex, 10M/half-duplex
Link down sense	Wireless LAN	Disable, enable
	Link down condition	Link status, Ping
Ping parameter	IP address	0.0.0.0
	Transmission interval (seconds)	60, 1 - 65535
	Response wait time	3, 1 - 15
	Number of retries	3, 0 - 15
Wireless LAN		
Interface		Enable, disable
Wireless LAN standard		IEEE802.11a, IEEE802.11g, IEEE802.11b
Wireless link mode		Standard, compatible, advanced (AP only)
Unit type		AP, station
XR function		Disable, enable
ESSID (32 alphanumeric characters, capital/small character distinction)		LocalGroup

Table 8.1. Initial Setting List <2 / 5 >

Item		Default setting
Channel No. (AP only)		(Depend on the country) See "8.3 List of Country Channels".
Transmission rate (*1)		IEEE802.11a: 54Mbps, 48Mbps, 36Mbps, 24Mbps, 18Mbps, 12Mbps, 9Mbps, 6Mbps IEEE802.11b: 11Mbps, 5.5Mbps, 2Mbps, 1Mbps IEEE802.11g: 54Mbps, 48Mbps, 36Mbps, 24Mbps, 18Mbps, 12Mbps, 9Mbps, 6Mbps, 11Mbps, 5.5Mbps, 2Mbps, 1Mbps
Transmission rate (Max.) (*1)		IEEE802.11a: 54Mbps, 48Mbps, 36Mbps, 24Mbps, 18Mbps, 12Mbps, 9Mbps, 6Mbps IEEE802.11b: 11Mbps, 5.5Mbps, 2Mbps, 1Mbps IEEE802.11g: 54Mbps, 48Mbps, 36Mbps, 24Mbps, 18Mbps, 12Mbps, 9Mbps, 6Mbps, 11Mbps, 5.5Mbps, 2Mbps, 1Mbps
Beacon transmission rate (AP only)		IEEE802.11a: 6Mbps, 54Mbps, 48Mbps, 36Mbps, 24Mbps, 18Mbps, 12Mbps, 9Mbps IEEE802.11b: 1Mbps, 11Mbps, 5.5Mbps, 2Mbps IEEE802.11g: 1Mbps, 54Mbps, 48Mbps, 36Mbps, 24Mbps, 18Mbps, 12Mbps, 9Mbps, 6Mbps, 11Mbps, 5.5Mbps, 2Mbps
Basic rate (AP only)		IEEE802.11g, OFDM: 11g (11g Only mode enabled) IEEE802.11b, IEEE802.11: 11g (11g Only mode disabled)/11b
Transmission output		MAX, 50%, 25%
Super A/G	Function	Disable, enable
	Frame bursting	Enable, disable
	Real-time compression	Enable, disable
802.11g parameter	802.11g Only mode (AP only)	Disable, enable
	Protect mode	Enabled, disable
	Protect type	CTS-only, RTS-CTS
Antenna selection		Auto, 1, 2
Multi client function (ST only)		Disable, enable
Static node address (ST only)		00-00-00-00-00-00 (Disable)
Max login number (AP only)		254, 1 - 254
Roaming Threshold (ST only)		24, 0 - 95:11a./g 24, 0 - 95:11b
Priority AP (ST only)	AP 1 - 5	00-00-00-00-00-00 (Disable)
	Connect to other APs	Enable, disable
Communication distance		Less than 1km, 1 - 10km, 10 - 20km, 20km or more
Load balancing	function	Disable, enable
	load balancing threshold (ST only)	30, 0 - 95

Table 8.1. Initial Setting List <3 / 5 >

Item	Default setting	
Beacon interval (AP only)	100, 20 · 1000 (ms)	
DTIM (AP only)	1, 1 · 255	
QoS	Disable, enable	
WDS (AP only)	Disable, enable	
Power-save Mode (ST only)	Disable, enable	
Scan Channels (ST only)	(No input)	
AP Aging Time (ST only)	120, 10 · 120 (seconds)	
Original Login Trial Time (ST only)	60, 3 · 60 (seconds)	
Disconnect Time (ST only)	10, 1 · 10 (seconds)	
IP Tunnel (ST only)	Enable, disable	
Roaming Notification Retry Count (ST only)	1, 0 · 3	
Encryption	Disable, WEP, AES, AES-OCB, TKIP	
WPA function	Disable, WPA-PSK, WPA2-PSK (AP only) WPA, WPA2, WPA-AUTO-PSK, WPA-AUTO	
Default key	#1, #2, #3, #4	
Size #1 · #4	Disable, 64bit (10digits), 128bit (26digits), 152bit (32digits): WEP Disable, 128bit (32 digits): AES / AES-OCB Disable: TKIP	
Key #1 · #4	(No input)	
Key update interval (AP only)	60, 0 · 65535 (minutes)	
WPA encryption key	(No input)	
WSL	Type	Disable, enable (Type1), enable (Type 2)
	Key	(No input)
ESSID security (AP only)	Disable, enable	
MAC address filtering (AP only)	Disable, enable	
IEEE802.1X		
IEEE802.1X function	Disable, enable	
MAC Address Authentication Function (AP only)	Disable, enable	
Reauthentication Interval (AP only)	60, 2 · 4320	
WPA Reauthentication (AP only)	Disable, enable	
WPA Reauthentication Interval (AP only)	1440, 2 · 4320	
(RADIUS server) IP address (AP only)	0.0.0.0	
(RADIUS server) Port number (AP only)	1812	
(RADIUS server) ESSID (AP only)	(No input)	
(RADIUS server) Pre-shared Key (AP only)	(No input)	

Table 8.1. Initial Setting List <4/5>

Item		Default setting
Extended function		
Bridge Packet Control		Disable, enable
Network time	Function	Disable, enable
	IP address	0.0.0.0 (Disable)
	Time zone	+09:00
Access control	TELNET server function	Enable, disable
	FTP server function	Enable, disable
	WEB server function	Enable, disable
	Administrator IP specification	Disable, enable
	Administrator IP address 1 - 2	0.0.0.0 (Disable)
Wireless access		Enable, disable
Network delay time (seconds)		0, 0 - 15
Setting file encryption		Disable, enable
Protocol Filter	Function	Disable, enable
	Operation of unspecified protocols	Allow, block
Roaming Notification	Send notification packets	Enable, disable
	First login notification	Enable, disable
	Notification packet bridge	Enable, disable
Delete System Files (INIT-SW)		Disable, enable
CPU Power-save Mode		Disable, enable
SNMP		
SNMP agent function		Disable, enable
Community name		public
Access right		Read/Write, Read Only
Trap destination IP address		0.0.0.0
sysContact		(No input)
sysLocation		(No input)
sysName		(No input)
Trap	Link state change (Ethernet)	Disable, enable
	Link state change (wireless LAN)	Disable, enable

Table 8.1. Initial Setting List <5 / 5 >

Item		Default setting
VLAN (AP only)		
VLAN function		Disable, enable
VLAN ID		1, 1 - 4094
Guest connection		Enable, disable
Guest VLAN ID		1, 1 - 4094
VLAN table	ESSID	(Empty)
	VLAN ID	(Empty), 1 - 4094
	Encryption	(Empty)
Log function		
Log function		Disable, enable
File save		Disable, enable
Overwrite mode		Enable, disable
Debug Log		Disable, enable
Starting day/time setting	Starting day/time setting function	Disable, enable
	Starting day/time	2002, January 1, 00:00
Setting on details	Log in	ON, OFF
	Log out	ON, OFF
	Log in NG	ON, OFF
	Roaming	ON, OFF
	Tunnel start	ON, OFF
	Tunnel stop	ON, OFF
	Application login	ON, OFF
	Application logout	ON, OFF
	Authentication	ON, OFF
	Date/Time Set	ON, OFF

*1 These are theoretical values based on their respective wireless LAN standards. They do not indicate actual data transfer rates.

*2 This varies depending on the encryption function of the wireless LAN in use.

Encryptions other than those described below	254
IEEE802.1X	124
AES (when using WPA function)	128
TKIP (when using WPA function)	32

Specifications

Table 8.2. Specifications < 1 / 2 >

Item		Specification
Wired LAN		
Ethernet standard		IEEE802.3(10BASE-T), IEEE802.3u(100BASE-TX)
Data transfer speed		10/100Mbps
Access method		CSMA/CD
Communication type		Half Duplex, Full Duplex
Number of ports		1 (10BASE-T/100BASE-TX)
Wireless LAN		
IEEE802.11a	Transmission format	IEEE802.11a-compliant OFDM (Orthogonal Frequency Division Multiplexing)
	Channel	(Depend on the country) See "8.3 List of Country Channels".
	Data transfer speed *1	54, 48, 36, 24, 18, 12, 9, 6Mbps (Fixed/Auto)
	Access method	CSMA/CA + ACK (RTS/CTS)
	Aerial power	10mW/MHz or less
	Security	WEP, WPA-PSK (AES, TKIP), WPA2-PSK (AES, TKIP), AES-OCB, WSL (Proprietary encryption) (AP only) WPA (AES, TKIP), WPA2 (AES, TKIP), MAC address filtering, IEEE802.1X (EAP-TLS, PEAP)
IEEE802.11b	Transmission format	IEEE 802.11b-compliant DSSS
	Channel	(Depend on the country) See "8.3 List of Country Channels".
	Data transfer speed *1	11, 5.5, 2, 1Mbps (Fixed/Auto)
	Access method	CSMA/CA + ACK (RTS/CTS)
	Aerial power	10mW/MHz or less
	Security	WEP, WPA-PSK (AES, TKIP), WPA2-PSK (AES, TKIP), AES-OCB, WSL (Proprietary encryption) (AP only) WPA (AES, TKIP), WPA2 (AES, TKIP), MAC address filtering, IEEE802.1X (EAP-TLS, PEAP)
IEEE802.11g	Transmission format	IEEE802.11g-compliant OFDM (Orthogonal Frequency Division Multiplexing)
	Channel	(Depend on the country) See "8.3 List of Country Channels".
	Data transfer speed *1	54, 48, 36, 24, 18, 12, 9, 6Mbps (Fixed/Auto)
	Access method	CSMA/CA + ACK (RTS/CTS)
	Aerial power	10mW/MHz or less
	Security	WEP, WPA-PSK (AES, TKIP), WPA2-PSK (AES, TKIP), AES-OCB, WSL (Proprietary encryption) (AP only) WPA (AES, TKIP), WPA2(AES, TKIP), MAC address filtering, IEEE802.1X (EAP-TLS, PEAP)

*1 These are theoretical values based on their respective wireless LAN standards. They do not indicate actual data transfer rates.

Table 8.2. Specifications < 2 / 2 >

Item	Specification
Antenna	Diversity dipole antenna
External Dimensions (mm)	25(W) x 68(D) x 97(H) (Not including antenna and other projecting parts)
Weight(g)	250g

Table 8.3. List of Country Channels

Standard	Channel*1				
	U.S.A. (NZ2WL-US)	Europe (NZ2WL-EU)	China (NZ2WL- CN)	Korea (NZ2WL-KR)	Taiwan (NZ2WL- TW)
IEEE802.11a	36, 40, 44, 48, 149, 153, 157, 161, 165ch	36, 40, 44, 48ch	149, 153, 157, 161, 165ch	36, 40, 44, 149, 153, 157, 161ch	149, 153, 157, 161, 165ch
IEEE802.11b/g	1-11ch	1-13ch	1-13ch	1-13ch	1-11ch

*1 The channels of this product can be changed only among the same models.

Software Specifications

Table 8.4. Software Specifications

Item	Specification
Protocols	IP(RFC791), ICMP(RFC792), UDP(RFC768), TCP(RFC793,896), ARP(RFC826), HTTPD(RFC1866), TELNET(RFC854), FTPD(RFC959), TFTP(RFC783,906), DHCP(RFC2131), SNTD(RFC1361), SNMP(RFC1067)

Installation Environment Requirements (Environmental Specifications)

Table 8.5. Installation Environment Requirements (Environmental Specifications)

Item	Specification
Input voltage range	12 - 24VDC±5%
Rating input current	0.4A(at 12VDC input), 0.2A(at 24VDC input) (Max.) Fuse /2.0A non-user serviceable (Rated interrupting current: 50A)
Operating ambient temperature	0 - 50°C
Operating ambient humidity	10 - 90%RH (No condensation)
Floating dust particles	Tolerant of small amounts (non excessive)
Corrosive gases	None

External Dimensions

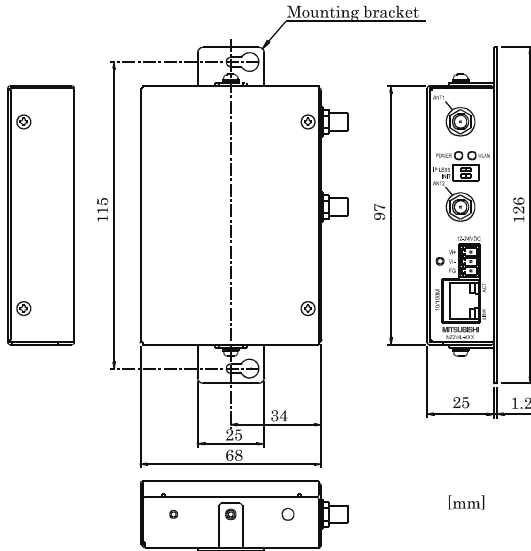

Figure 8.2. External Dimensions
(when installed with mounting brackets)

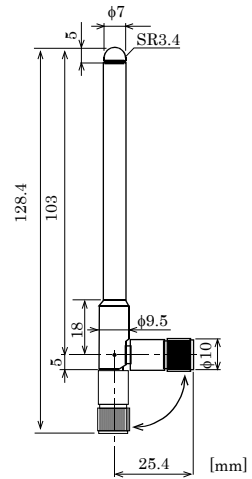
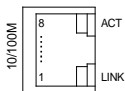

Figure 8.3. Antenna Dimensions

Pin Layout of LAN Port

Table 8.6. Pin Layout of LAN Port



Pin No.	Signal name
1	TX+
2	TX-
3	RX+
4	-
5	-
6	RX-
7	-
8	-

WARRANTY

Please confirm the following product warranty details before using this product.

1. Gratis Warranty Term and Gratis Warranty Range

If any faults or defects (hereinafter "Failure") found to be the responsibility of Mitsubishi occurs during use of the product within the gratis warranty term, the product shall be repaired at no cost via the sales representative or Mitsubishi Service Company.

However, if repairs are required onsite at domestic or overseas location, expenses to send an engineer will be solely at the customer's discretion. Mitsubishi shall not be held responsible for any re-commissioning, maintenance, or testing on-site that involves replacement of the failed module.

[Gratis Warranty Term]

The gratis warranty term of the product shall be for one year after the date of purchase or delivery to a designated place.

Note that after manufacture and shipment from Mitsubishi, the maximum distribution period shall be six (6) months, and the longest gratis warranty term after manufacturing shall be eighteen (18) months. The gratis warranty term of repair parts shall not exceed the gratis warranty term before repairs.

[Gratis Warranty Range]

- (1) The range shall be limited to normal use within the usage state, usage methods and usage environment, etc., which follow the conditions and precautions, etc., given in the instruction manual, user's manual and caution labels on the product.
- (2) Even within the gratis warranty term, repairs shall be charged for in the following cases.
 1. Failure occurring from inappropriate storage or handling, carelessness or negligence by the user. Failure caused by the user's hardware or software design.
 2. Failure caused by unapproved modifications, etc., to the product by the user.
 3. When the Mitsubishi product is assembled into a user's device, Failure that could have been avoided if functions or structures, judged as necessary in the legal safety measures the user's device is subject to or as necessary by industry standards, had been provided.
 4. Failure that could have been avoided if consumable parts designated in the instruction manual had been correctly serviced or replaced.
 5. Failure caused by external irresistible forces such as fires or abnormal voltages, and Failure caused by force majeure such as earthquakes, lightning, wind and water damage.
 6. Failure caused by reasons unpredictable by scientific technology standards at time of shipment from Mitsubishi.
 7. Any other failure found not to be the responsibility of Mitsubishi or that admitted not to be so by the user.

2. Onerous repair term after discontinuation of production

(1) Mitsubishi shall accept onerous product repairs for six (6) years after production of the product is discontinued.

Discontinuation of production shall be notified with Mitsubishi Technical Bulletins, etc.

(2) Product supply (including repair parts) is not available after production is discontinued.

3. Overseas service

Overseas, repairs shall be accepted by Mitsubishi's local overseas FA Center. Note that the repair conditions at each FA Center may differ.

4. Exclusion of loss in opportunity and secondary loss from warranty liability

Regardless of the gratis warranty term, Mitsubishi shall not be liable for compensation to:

(1) Damages caused by any cause found not to be the responsibility of Mitsubishi.

(2) Loss in opportunity, lost profits incurred to the user by Failures of Mitsubishi products.

(3) Special damages and secondary damages whether foreseeable or not, compensation for accidents, and compensation for damages to products other than Mitsubishi products.

(4) Replacement by the user, maintenance of on-site equipment, start-up test run and other tasks.

5. Changes in product specifications

The specifications given in the catalogs, manuals or technical documents are subject to change without prior notice.

Major differences in after-sales service compared to MELSEC iQ-R Series, MELSEC-Q/L Series, and others
--

- | |
|--|
| (1) The gratis warranty term of the product shall be for one (1) year after the date of delivery or for eighteen (18) months after manufacturing, whichever is less. |
| (2) The onerous repair term after discontinuation of production shall be for six (6) years. |
| (3) Mitsubishi shall mainly replace products that need repair. |
| (4) It may take some time to respond to the problem or repair the product depending on the condition and timing. |

R&TTE Directive

Compliance with the R&TTE Directive, which is one of the EU directives, has been mandatory for the products sold within EU member states since 1999.

To prove the compliance with the R&TTE Directive, manufactures must issue an EC Declaration of Conformity and the products must bear a CE marking.

This product is compliant with EN300 328/EN301 893/EN301 489-1,-17/

EN55022/EN55024/EN61000-3-2,-3-3/EN60950-1.

(1) Sales representative in EU member states

The sales representative in EU member states will be:

Company name : Mitsubishi Electric Europe BV

Address : Gothaer strasse 8, 40880 Ratingen, Germany

Revisions

*The manual number is given on the bottom right of the cover.

Print Date	*Manual Number	Revision
March 2011	IB (NA) -0800471ENG-A	First edition
October 2011	IB (NA) -0800471ENG-B	<p>Partially revised NZ2WL-xxx Country Channels</p> <p>Partially addition FCC PART15, R&TTE Directive, NCC Certification addenda FCC Notice, R&TTE Directive</p>
November 2011	IB (NA) -0800471ENG-C	<p>Partially revised Table of Contents</p>
November 2015	IB (NA) -0800471ENG-D	<p>Partially revised Handling Precautions, Connection to MELSEC Series Equipment, Chapter 2, 5, 8, WARRANTY</p>

Country/Region	Sales office/Tel	Country/Region	Sales office/Tel
USA	Mitsubishi Electric Automation Inc. 500 Corporate Woods Parkway, Vernon Hills, IL 60061, USA Tel : +1-847-478-2100	South Africa	CBI-Electric. Private Bag 2016, ZA-1600 Isando, South Africa Tel : +27-11-977-0770
Brazil	MELCO-TEC Representacao Comercial e Assessoria Tecnica Ltda. Av. Paulista, 1439, cj74, Bela Vista, Sao Paulo CEP: 01311-200-SP Brazil Tel : +55-11-3146-2200	China	Mitsubishi Electric Automation (China) Ltd. No.1386 Hongqiao Road, Mitsubishi Electric Automation Center, Changning District, Shanghai, China Tel : +86-21-2322-3030
Germany	Mitsubishi Electric Europe B.V. German Branch Gothaer Strasse 8, D-40880 Ratingen, Germany Tel : +49-2102-486-0	Taiwan	Setsuyo Enterprise Co., Ltd. 6F., No.105, Wugong 3rd Road, Wugu District, New Taipei City 24889, Taiwan, R.O.C. Tel : +886-2-2299-2499
UK	Mitsubishi Electric Europe B.V. UK Branch Travellers Lane, Hatfield, Hertfordshire, AL10 8XB, UK. Tel : +44-1707-27-6100	Korea	Mitsubishi Electric Automation Korea Co., Ltd. 3F, 1480-6, Gayang-Dong, Gangseo-Gu, Seoul, 157-200, Korea Tel : +82-2-3660-9530
Italy	Mitsubishi Electric Europe B.V. Italian Branch Viale Colleoni 7-20864 Agrate Brianza (Milano), Italy Tel : +39-039-60531	Singapore	Mitsubishi Electric Asia Pte. Ltd. Industrial Division 307, Alexandra Road, Mitsubishi Electric Building, Singapore, 159943 Tel : +65-6470-2308
Spain	Mitsubishi Electric Europe B.V. Spanish Branch Carretera de Rubi 76-80.AC.420, E-08190 Sant Cugat del Valles (Barcelona), Spain Tel : +34-93-565-3131	Thailand	Mitsubishi Electric Automation (Thailand) Co., Ltd. Bang-Chan Industrial Estate No.111 Soi Serithai 54, T.Kannayao, A.Kannayao, Bangkok 10230 Thailand Tel : +66-2906-3238
France	Mitsubishi Electric Europe B.V. French Branch 25, Boulevard des Bouvets, F-92741 Nanterre Cedex, France Tel : +33-1-5568-5568	Indonesia	P. T. Autoteknindo Sumber Makmur Muara Karang Selatan, Block A / Utara No.1 Kav. No. 11, Kawasan Industri Pergudangan, Jakarta-Utara 14440, P.O, Box 5045, Indonesia Tel : +62-21-663-0833
Czech Republic	Mitsubishi Electric Europe B.V.-o.s.Czech office Avenir Business Park, Radicka 751/113e, 158 00 Praha5, Czech Republic Tel : +420-251-551-470	India	Mitsubishi Electric India Pvt. Ltd. 2nd Floor, Tower A & B, Cyber Greens, DLF Cyber City, DLF Phase-III, Gurgaon-122002 Haryana, India Tel : +91-124-463-0300
Poland	Mitsubishi Electric Europe B.V. Polish Branch ul. Krakowska 50, 32-083 Balice, Poland Tel : +48-12-630-47-00	Australia	Mitsubishi Electric Australia Pty. Ltd. 348 Victoria Road PO BOX11, Rydalmere, N.S.W 2116, Australia Tel : +61-2-9684-7777
Russia	Mitsubishi Electric Europe B.V. Russian Branch St.Petersburg office Piskarevsky pr. 2, bld 2, lit "Sch", BC "Benua", office 720; 195027, St. Petersburg, Russia Tel : +7-812-633-3497		

MITSUBISHI ELECTRIC CORPORATION

HEAD OFFICE : TOKYO BUILDING, 2-7-3 MARUNOUCHI, CHIYODA-KU, TOKYO 100-8310, JAPAN
NAGOYA WORKS : 1-14, YADA-MINAMI 5-CHOME, HIGASHI-KU, NAGOYA, JAPAN

When exported from Japan, this manual does not require application to the Ministry of Economy, Trade and Industry for service transaction permission.

Specifications subject to change without notice.