



# Honeywell/34

Weekday/Saturday/Sunday  
 Programmable Heat and/or Cool  
 Low Voltage (20 to 30 Vac) Thermostat and Wallplate  
 Model CT3400/CT3455

## PROGRAMMABLE THERMOSTAT

# Honeywell

### TYPICAL ENERGY SAVINGS FOR REPRESENTATIVE CITIES IN THE U.S. AND CANADA

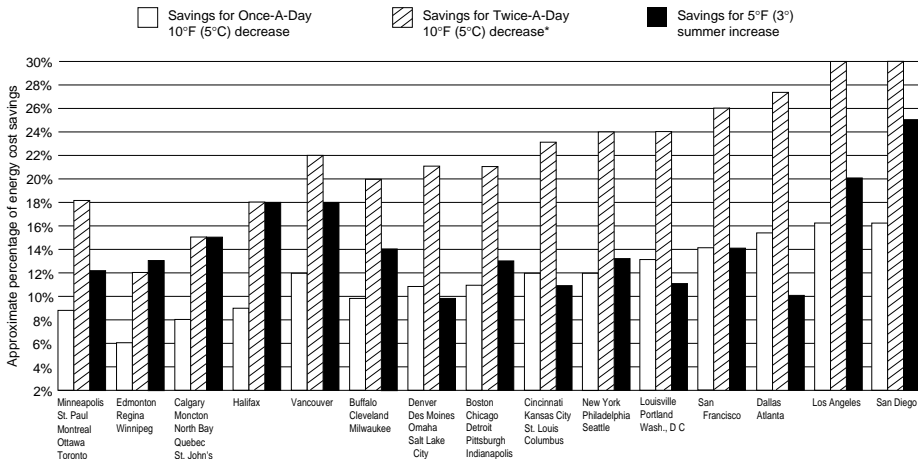

\*Based on 10°F (5°C) decrease—5°F [3°C] decrease gives approximately 55 percent of these savings).

M2416A

# TOTAL COMFORT TEMPERATURE MANAGEMENT WITH ADAPTIVE INTELLIGENT RECOVERY™

Congratulations! You made a smart choice when you purchased your new Honeywell Thermostat. It's the smart thermostat that:

- *Keeps you comfortable* by automatically calculating exactly when the furnace or air conditioning should go on to have the house at the desired comfort temperature by the time you wake up or return home.
- *Saves the maximum amount of energy and money* by remembering to automatically adjust the heat or air conditioning when you leave home or go to sleep.
- *Provides the ultimate in comfort and convenience.* It comes already programmed, so it's your choice—use the preprogrammed schedule or set your own.

We invite you to spend a few minutes reading this manual. You'll find it answers many of the questions that will arise as you become familiar and comfortable with your Honeywell thermostat, the state of the art in home comfort controls.



## Recycling Thermostat

If this thermostat is replacing a control that contains mercury in a sealed tube, do *not* place your old control in the trash. Contact your local waste management authority for instructions regarding recycling and the proper disposal of this control, or of an old control containing mercury in a sealed tube.

If you have questions, call Honeywell Inc. at 1-800-468-1502.

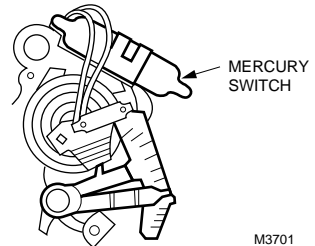

M3701

**Fig. 1. Typical location of a mercury switch in a thermostat.**



# Table Of Contents

STEP 1 Prepare For Installation .....	2
STEP 2 Remove Old Thermostat .....	4
STEP 3 Before You Program .....	6
Install the Batteries .....	6
Adaptive Intelligent Recovery™ Selection .....	7
STEP 4 Program The Thermostat .....	9
STEP 5 Mount Thermostat Wallplate .....	16
STEP 6 Adjust System On-Time, Clock Display, as Required .....	18
STEP 7 Adjust Fan Operation Switch, as Required .....	20
STEP 8 Wire Wallplate Terminals .....	21
STEP 9 Mount The Thermostat .....	24
STEP 10 Check Thermostat Operation After Programming and Installing .....	25
STEP 11 Set the Fan and System Switches .....	28
Troubleshooting Guide .....	30
Index .....	34
Limited One-Year Warranty .....	36

## STEP 1 Prepare For Installation

☐ Check Table 1 to make sure this thermostat is compatible with your system. If not, return to retailer. For more information, call Honeywell Customer Assistance, toll-free 1-800-468-1502.

Table 1. Compatibility Chart.

System Type	Compatible with CT3400/3455
Gas—Standing Pilot	Yes
Gas—Electronic Ignition	Yes
Gas-Fired Boilers	Yes 
<i>Gas—Millivolt</i>	No
Oil-Fired Boilers	Yes 
Oil-Fired Furnace	Yes
Electric Furnace	Yes
Electric Air Conditioning	Yes
<i>Baseboard Electric (120/240 line volt)</i>	No
<i>Heat Pumps/Multistage Equipment</i>	No

Not compatible with any 120/240 volt circuit.

 Compatible with 2-wire Honeywell and Taco zone valves. Not compatible with 3-wire zone valves or 2-wire White Rodgers no. 1361 valves.

- Acquire tools and items as needed (below).

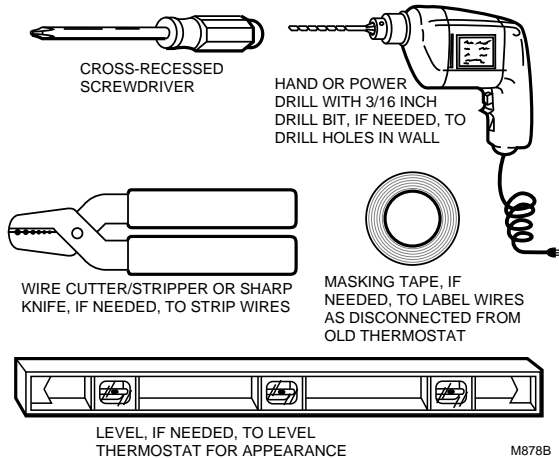

3

69-0733—3

## STEP 2 Remove Old Thermostat

- Test to make certain that your heating and cooling systems are working properly. If either does not work, contact your local heating/air conditioning dealer. To avoid compressor damage, do not operate the cooling system when outdoor temperature is below 50°F (10°C).
- Turn off power to system at the furnace, or at the fuse/circuit breaker panel.
- Carefully unpack your new thermostat and wallplate; save package of screws, instructions and receipt.
- Remove the cover from the old thermostat. If it does not snap off when pulled firmly from the bottom, check for a screw used to lock on the cover.
- Loosen screws holding thermostat to sub-base, wallplate or wall, and lift away.

- Disconnect wires from old thermostat or subbase. As you disconnect each wire, use masking tape to label it with the old terminal designation. If there are only two wires, they do not need to be labeled. Wrap wires around pencil to keep them from falling back into the wall, as shown.

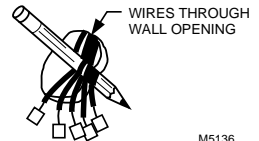

### Replacing a clock thermostat that has C or C1 clock terminals?

If you are replacing a Honeywell Chronotherm® Thermostat, you may find one or two wires that go to the C or C1 clock terminals on the Chronotherm® Thermostat wiring wallplate. Do

4

69-0733—3

not allow them to touch, or you can damage your transformer. Disconnect the wires and wrap them separately using electrical tape; *do not wrap them together*. Place the wires where they will not interfere with the operation of the new thermostat. Record the colors and terminal designation labels of the remaining wires.

### Six or more wires?

If there are six or more wires (excluding clock wires attached to terminals), you most likely have a variation of a heat pump or multistage system. The thermostat is *not* compatible with such systems so return the product to the place of purchase. If you would like information about

which programmable thermostats will work with your system, call Honeywell Customer Assistance at 1-800-468-1502.

### Three thermostat wires?

If you have three wires for heating only and can operate the fan using the fan ON switch, this thermostat will work with your system. However, some hot water (zoned) heating systems have three thermostat wires. The thermostat will not work without installing an isolating relay on these systems. For details, call Honeywell Customer Assistance at 1-800-468-1502.

## STEP 3 Before You Program

### Install the Batteries

**IMPORTANT:** *Three AA alkaline batteries are included with the thermostat. Batteries must be installed for programming and operation of the thermostat and heating/cooling system.*

- Install the batteries in back of the thermostat as shown, making sure positive (+) terminals all face toward the right.

As the batteries are running low, a REPL BAT indicator will flash for 1 to 2 months before batteries run out completely. Replace the batteries as soon as possible after the indicator starts flashing.

If you insert new batteries within 20 to 30 seconds of removing the old ones, you will not have to reprogram the thermostat. However, if the display is blank, the batteries are dead or incorrectly installed. In this case, you will have to reprogram. See pages 13 through 15 to reprogram. If you do not reprogram, the factory-preprogrammed settings will be in effect, as shown in chart on pages 11 and 12.

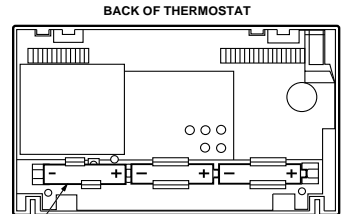

INSTALL 3 AA ALKALINE BATTERIES AS SHOWN.  
POSITIVE (+) TERMINALS TOWARD RIGHT.

**IMPORTANT:** *Although the thermostat has a low battery indicator, replace the batteries once a year to prevent leakage and to prevent the thermostat and heating/cooling system from shutting down due to lack of battery power.*

As a precaution when leaving home for longer than a month, change batteries before you leave to prevent system from shutting down due to lack of battery power.

Use fresh alkaline batteries; nonalkaline batteries do not last as long, and may leak, causing damage to the thermostat or the wall surface. We recommend Energizer® batteries.

7

69-0733—3

### More about Adaptive Intelligent Recovery™...

This thermostat is actually a small but powerful computer. When calculating the exact time to turn on your furnace or air conditioner, it considers: (1) air temperature, (2) the temperature of the wall and (3) when you want the comfort temperature established.

During recovery, the thermostat increases the control temperature gradually and turns the equipment on and off several times *before* reaching your comfort time to save energy by avoiding overshooting the comfort temperature. You can see the current control temperature anytime during recovery by pressing the CURRENT SETTING key.

This smart control learns from experience. Each day it checks how closely it hit the target and adjusts the recovery start time accordingly. It normally takes *four to eight days after installation*

## Adaptive Intelligent Recovery™ Selection

Before you program your thermostat, you must decide if you want to leave the thermostat at the factory-set Adaptive Intelligent Recovery™ setting, or adjust it to conventional recovery. If you choose conventional recovery, adjust screw 3A (on the back of the thermostat) by turning *out* one turn.

With Adaptive Intelligent Recovery™, your home gradually reaches the comfort temperature you set at the exact time programmed into the thermostat to achieve maximum energy savings and comfort.

for the thermostat to adjust to the weather, your lifestyle, home construction and heating/cooling system.

With conventional recovery, the programmed time marks the start of the time your furnace or air conditioner comes on to start recovery; therefore, you should program the start time to be earlier than the desired comfort time. The best starting time varies as the seasons change, but 30 minutes is a good head start time to use.

**NOTE:** If you adjust screw 3A for conventional recovery, a  indicator appears in the lower right corner of the thermostat display as a reminder that you are no longer using the Adaptive Intelligent Recovery™ feature.

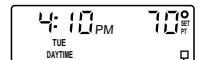

INDICATES THERMOSTAT IS SET FOR CONVENTIONAL RECOVERY  
M2483

8

69-0733—3

## STEP 4 Program The Thermostat

After the batteries are installed, the thermostat can be easily programmed in your hand before it is installed on the wall.

If you would prefer to program the thermostat after it is installed on the wall, skip to page 16, and return later to this programming section.

The following personal programming chart (pages 11 and 12) may be helpful when planning your program schedule of time and temperature settings for various times of the day.

Four time periods are available—MORNING, DAYTIME, EVENING and NIGHT. Each period has its own setting key.

MORNING is the time period you want the house at a comfortable temperature when you get up and while you get ready for

work or school. (This will be a higher temperature during heating season, or a lower temperature during cooling season.)

DAYTIME is the time period you can set for an energy-saving temperature while you are away at work or school. (This will be a lower temperature during heating season, or a higher temperature during cooling season.)

EVENING is the time period you want the house at a comfortable temperature for activities before bedtime. (Again, higher heat or lower cool.)

NIGHT is the time period you can set for an energy-saving temperature while you are sleeping. (Again, lower heat or higher cool. Although for more comfortable sleeping, some people choose not to raise the cool temperature during the night.)

9

69-0733—3

You will set one schedule for weekdays, one for Saturday, and another for Sunday, because your requirements will probably be different for each.

Fill in the times and temperatures you desire for weekdays, Saturday, Sunday. The factory-pre-programmed time and temperature settings are shown in parentheses. If you decide not to program the thermostat, it automatically controls to these settings. The thermostat requires a time and temperature program for the MORNING period. You can program DAYTIME and EVENING, or leave them blank. You can also change NIGHT or cancel it (see page 15), as you please.



Before programming, remove the clear plastic overlay covering the display.

When pressing the keys, use the ball of your finger or a soft pencil eraser. Use of sharp fingernails or pencil points can damage the keypad.



If at any time during programming you make an error, just press the RUN PROGRAM key, and continue again at the step where you left off.

# Personal Programming Chart

## Weekday Program

PERIOD	START TIME	HEATING TEMPERATURE 	COOLING TEMPERATURE 
MORNING	(6:00 AM) _____	(70°F [21°C]) _____	(78°F [26°C]) _____
DAYTIME	_____	_____	_____
EVENING	_____	_____	_____
NIGHT	(10:00 PM) _____	(60°F [16°C]) _____	(78°F [26°C]) _____



## Saturday Program

PERIOD	START TIME	HEATING TEMPERATURE 	COOLING TEMPERATURE 
MORNING	(6:00 AM) _____	(70°F [21°C]) _____	(78°F [26°C]) _____
DAYTIME	_____	_____	_____
EVENING	_____	_____	_____
NIGHT	(10:00 PM) _____	(60°F [16°C]) _____	(78°F [26°C]) _____

11

69-0733—3

## Sunday Program

PERIOD	START TIME	HEATING TEMPERATURE 	COOLING TEMPERATURE 
MORNING	(6:00 AM) _____	(70°F [21°C]) _____	(78°F [26°C]) _____
DAYTIME	_____	_____	_____
EVENING	_____	_____	_____
NIGHT	(10:00 PM) _____	(60°F [16°C]) _____	(78°F [26°C]) _____



 The temperatures cannot be set any higher than 88°F (31°C) or any lower than 45°F (7°C).

NOTE: The factory-preprogrammed time and temperature settings are shown in parentheses.



When programming your new thermostat, use this guide. Batteries are required for programming and operation.



### SET PRESENT DAY





Press and release  then  until present day shows.

### SET PRESENT TIME

Press and release  then <sup>a</sup> until present time shows.

### HEATING PROGRAM

With system switch at HEAT, press and release . Use <sup>a</sup> and <sup>a</sup> to program Mon-Fri MORNING time and temperature. Repeat using DAYTIME, EVENING, NIGHT keys.

For Saturday, press  to SAT. Press and release ; use <sup>a</sup> and <sup>a</sup> to program Saturday morning time and temperature. Repeat using DAYTIME, EVENING, NIGHT keys.

For Sunday, press  to SUN. Repeat steps as you did for SAT.



13

69-0733—3

### COOLING PROGRAM

The times you set for heating remain the same for cooling; you only need to program the temperatures.

With system switch at COOL, press and release . Use <sup>a</sup> to program Mon-Fri MORNING temperature. Repeat using DAYTIME, EVENING, NIGHT keys.



For Saturday, press  to SAT. Press and release ; use <sup>a</sup> to program

Saturday morning temperature. Repeat using DAYTIME, EVENING, NIGHT keys.



For Sunday, press  to SUN. Repeat steps as you did for SAT.



After programming, adjust fan and system switches as desired.

Press and release  to start the program.

<sup>a</sup> Press on  to move number back; press on  to move number ahead.

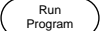
For operating or making changes, use this guide.

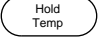
**Temporarily Change** temperature *for current period only*—  Temp <sup>a</sup>; TEMPORARY indicator shows on display, and cancels itself at next scheduled change. To cancel sooner, you may press .

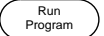

**Hold** a temperature indefinitely (such as on vacation)— ,  Temp <sup>a</sup> Hold appears on display; to cancel, press .

**Check** current temperature setting— .

**Cancel** a program—Press and hold ,  or  three seconds to cancel. Morning cannot be cancelled (only changed).

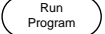
**Permanently Change** a program—Repeat steps under Heating Program (page 13) or Cooling Program (page 14), as applicable.

**Return** to normal program or start program— .

<sup>a</sup> Press on  to move number back; press on  to move number ahead.

15

69-0733—3

## STEP 5 Mount Thermostat Wallplate

Position wallplate on wall. Level the wallplate for appearance only. Use a pencil to mark the two mounting holes that best fit the application.

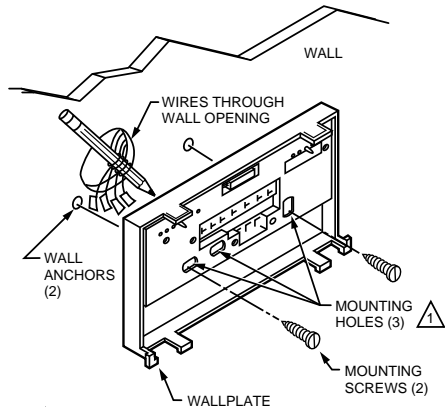

 USE THE TWO MOUNTING HOLES THAT BEST FIT APPLICATION.

M5932A

16

69-0733—3

**INSTALLATION**

Remove wallplate from wall, and drill 3/16 inch holes in wall (if drywall) as marked. For firmer material such as plaster or wood, drill 7/32 inch holes. Gently tap anchors (provided) into drilled holes until flush with the wall.

Reposition wallplate over holes, pulling wires through wiring opening. Loosely insert two mounting screws into holes.

Level for appearance only; thermostat functions properly even when not level. Tighten mounting screws.

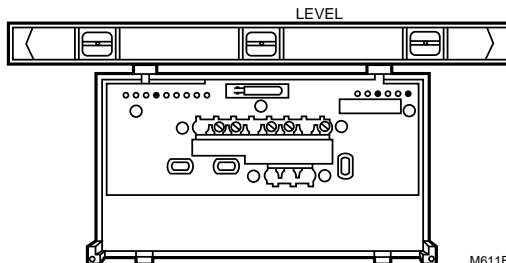

## **STEP 6** Adjust System On-Time, Clock Display, As Required

The thermostat on-time is factory-set for a warm air, gas or oil heating system. If you are installing it on another type of system, the on-time must be adjusted accordingly by setting screws 1A and 1B on the back of the thermostat, using the heating system table in the illustration as a guide. The system on-time should be optimized with the type of system to minimize room temperature swings. Setting the screw out one turn means turning the screw approximately 360° counterclockwise, or about one complete turn.

In the unlikely event that you want longer furnace on-time, readjust screws 1A and/or 1B as follows:

First, turn both screws in completely, then adjust for system type:

- Hot Water or High Efficiency—Set at the Gravity Air/Water setting (1A—out one turn, 1B—out one turn).
- Gas/Oil Warm Air—Set at the Hot Water or High Efficiency setting (1A—leave in, 1B—out one turn).
- Electric Warm Air—Leave at the Gas/Oil Warm Air setting (1A—leave in, 1B—leave in).

**IMPORTANT:** When using a high efficiency furnace such as a 90% or greater AFUE (Average Fuel Utilization Efficiency) unit, leave screw 1A in and screw 1B out one turn.

□ The thermostat is set to display the time as a 12-hour clock and the temperature in degrees Fahrenheit. If a 24-hour clock (e.g., military time) or degrees Celsius readings are desired, adjust screws 2A and 2B as necessary using the illustration as a guide.

□ For an explanation of the Recovery Selection screws (3A), see pages 7 and 8.

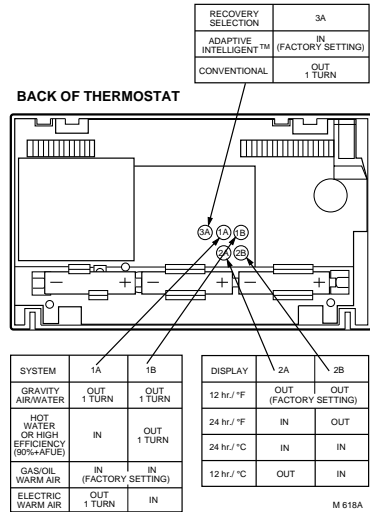

19

69-0733—3

## STEP 7 Adjust Fan Operation Switch, As Required

□ The thermostat fan operation switch is factory-set in the left (NON ELEC) position. This is the correct setting for most systems. If your system is an electric furnace, set the switch to the right (ELEC) position. The ELEC position allows the fan to turn on immediately with the heating or cooling system if the G terminal is connected to a fan relay.

**NOTE:** Either the switch must be set before the batteries are installed, or the left battery must be removed to access the switch.

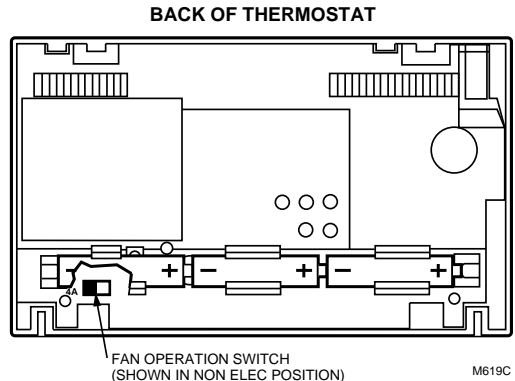

20

69-0733—3

# STEP 8 Wire Wallplate Terminals

**NOTE:** All wiring must comply with local codes and ordinances. If unsure about household wiring procedures, call your local heating/air conditioning contractor.

Refer to masking tape labels you placed on wires when you removed your old thermostat.

☐ Match the letter of your old thermostat wire with the terminal of the corresponding letter on your new thermostat. Refer to illustrations on pages 22 and 23.

**In 5-wire installations only, be sure to remove the factory-installed jumper connecting terminals R and Rc.**

☐ Loosen the terminal screws and slip each wire beneath its matching terminal. Either straight or wraparound wiring connections are acceptable (see illustration). Tighten terminals.

☐ Plug the hole in the wall with insulation to help prevent drafts from adversely affecting thermostat operation.

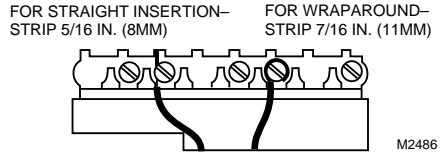

21

69-0733—3

**2-WIRE HEAT-ONLY (JUMPER INTACT)**

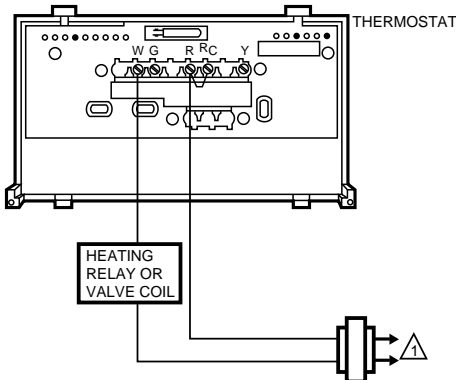

⚠ POWER SUPPLY. PROVIDE DISCONNECT MEANS AND OVERLOAD PROTECTION AS REQUIRED.

M612A

**4-WIRE HEAT/COOL (JUMPER INTACT)**

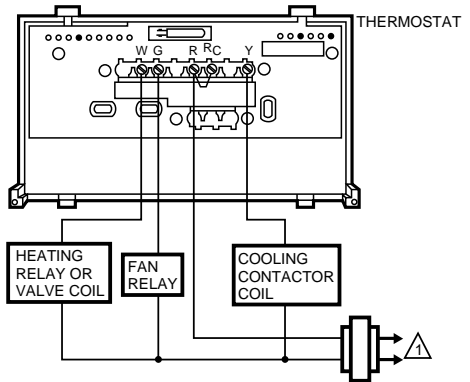

⚠ POWER SUPPLY. PROVIDE DISCONNECT MEANS AND OVERLOAD PROTECTION AS REQUIRED.

M614A

22

69-0733—3

### 3-WIRE HEAT ONLY (JUMPER INTACT)

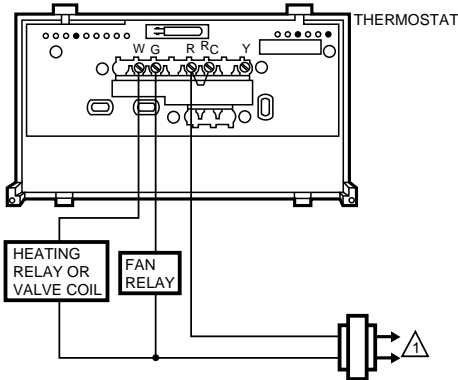

**⚠** POWER SUPPLY. PROVIDE DISCONNECT MEANS AND OVERLOAD PROTECTION AS REQUIRED.

M613A

### 5-WIRE HEAT/COOL (JUMPER REMOVED)

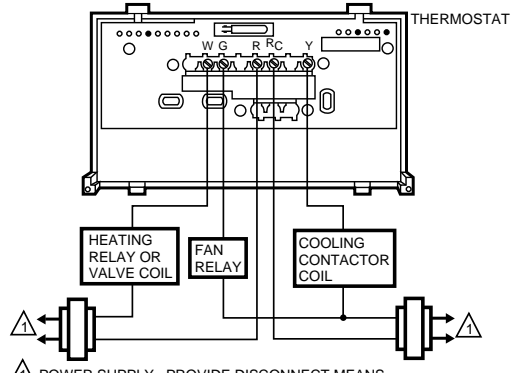

**⚠** POWER SUPPLY. PROVIDE DISCONNECT MEANS AND OVERLOAD PROTECTION AS REQUIRED.

M 615A

23

69-0733—3

## STEP 9 Mount The Thermostat

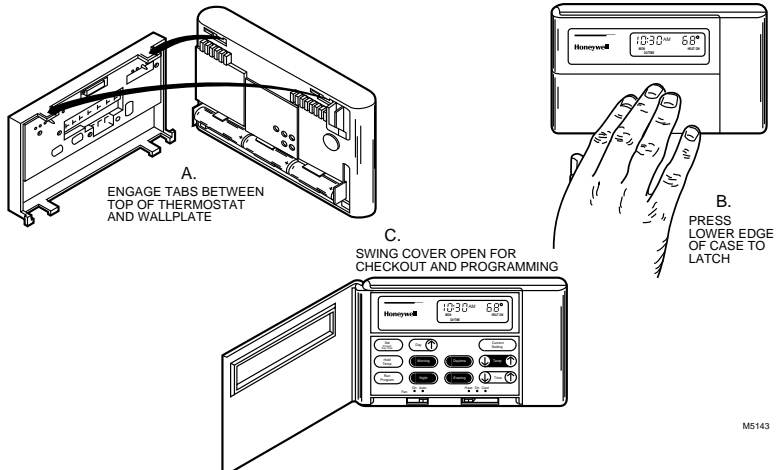

M5143

24

69-0733—3

**INSTALLATION**

# STEP 10 Check Thermostat Operation After Programming And Installing

## HEATING

Do *not* check heating system operation by jumpering thermostat terminals at the primary control, such as the gas valve, zone valve, oil burner control. This will damage the thermostat. Instead, you could jumper R and W wires at the thermostat.

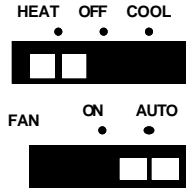

Move the system switch to HEAT and the fan switch to AUTO.



Press up arrow of key until the setting is about 10°F (6°C) above room temperature. Heating should start and the fan should run after a short delay (immediately if fan operation switch is set in ELEC position).

## COOLING

To avoid possible compressor damage, do not operate the cooling system when outside temperature is below 50°F (10°C). See compressor manufacturer instructions for further information.

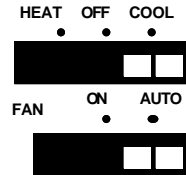

Move the system switch to COOL and the fan switch to AUTO.



Press down arrow of key until setting is about 10°F (6°C) below room temperature. The cooling equipment and fan should start.

**NOTE:** When cooling setting is changed, thermostat may delay up to five minutes before turning on the air conditioner. This delay protects the compressor.



Press up arrow of key until the setting is about 10°F (6°C) above room temperature. The cooling equipment and fan should stop.

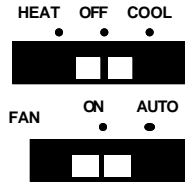

Move the system switch to OFF and the fan switch to ON. The fan should run continuously. When the fan switch is in the AUTO position, fan cycles with the heating or cooling system.

## STEP 11 Set The Fan And System Switches

First set the fan switch.

**FAN ON:** The fan runs continuously. Use for improved air circulation during special occasions or for more efficient electronic air cleaning. (In a heat-only system, fan runs continuously only if fan relay is connected to the thermostat.)

**FAN AUTO:** Normal setting for most homes. A single-speed fan turns on automatically with the air conditioner or furnace. A two-speed fan usually runs on high with the air conditioner and on low with the furnace.

**Exception:** If fan operation switch on back of thermostat is set to the ELEC (right) position (see page 20), fan operates with furnace only.

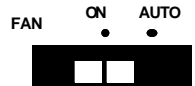



Then set the system switch.

**HEAT:** The thermostat controls your heating system.



**OFF:** Both the heating and air conditioning systems are off.



**COOL:** The thermostat controls your air conditioning system.

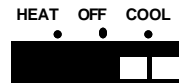

## Troubleshooting Guide

***IF...***  
**Display does not come on.**

***THEN...***

- Set the system switch to OFF. Remove batteries. Insert backward for at least five seconds to reset thermostat. Replace batteries correctly. Display should come on.
- Make sure batteries are fresh and installed correctly.
- Gently clean battery contacts using a soft pencil eraser. Do not use anything abrasive on the clips.
- You have reached the temperature setting limit. The setting range is 45°F to 88°F (7°C to 31°C).

**Display flashes during programming.**

**Temperature change occurs at the wrong times.**

- Check the program times for the period in question. Be sure that AM and PM indications are correct. Make sure the current day and time are correct. Reprogram if necessary.
- If you left the thermostat set for Adaptive Intelligent Recovery™, the start times will occur before your programmed comfort periods.

**Heating does not come on.**

- Check that switch on thermostat is set to HEAT.
- Check the system fuse or circuit breaker and replace or reset if necessary. If display is blank or displays REPL BAT, install fresh batteries.
- Check for correct wiring and good connections.
- Jumper wires R and W. If heat does not come on, contact your heating dealer.
- If temperature setting is higher than current temperature, and HEAT ON is displayed, contact Honeywell Customer Assistance at 1-800-468-1502.

**Cooling does not come on.**

- Check that switch on thermostat is set to COOL.
- Check the system fuse or circuit breaker and replace or reset if necessary. If display is blank or displays REPL BAT, install fresh batteries.
- Check for correct wiring and good connections.

- Jumper wires Rc and Y. If cooling does not come on, contact your cooling dealer.
- The thermostat has a built-in time delay on cooling. Allow up to ten minutes after changing the setting before the air conditioner starts.
- Make sure outdoor disconnect is energized (on).
- If temperature setting is lower than current temperature, and COOL is displayed, move system switch from COOL to OFF for ten minutes. After ten minutes, return the switch to the COOL position. If your air conditioner comes on, this indicates your compressor may have reached its high limit temperature protection and shut down. If your air conditioner does not come on after ten minutes and COOL is displayed, contact Honeywell Customer Assistance at 1-800-468-1502.
- If 2- or 4-wire installation, verify that R-Rc jumper is installed.

**The house is too warm or too cool.**

- Press CURRENT SETTING to check the current temperature setting.
- If desired, change the temperature setting. See page 15.

**HEAT ON is displayed, but no heat is coming from the registers.**

**The system cycle length is too short or too long.**

**The thermostat's current setting does not match the display temperature to within  $\pm 1^\circ$ .**

**Incorrect room temperature showing on thermostat display.**

- Allow time for the furnace to heat up and the fan to come on before checking for heat at the register. Note that on most gas and oil systems, the fan is not controlled by the thermostat, but by another control, which may account for the delay.
- Readjust according to instructions on pages 18 and 19.
- Check that the wiring hole in the wall behind the wallplate has been plugged with insulation to prevent drafts that might adversely affect thermostat operation.
- Be aware that it is normal for the current setting and display temperature to differ occasionally.
- Make sure the hole behind the thermostat is plugged with insulation to help prevent drafts from adversely affecting the thermostat operation.
- The thermostat is factory-calibrated and cannot be adjusted.

## Index

Adaptive Intelligent Recovery™ .....	7,8	Fan switch .....	29	Set fan switch .....	28
Batteries, installation .....	6	Flashing display .....	6	Set cooling temperatures .....	14
Batteries, replacement .....	6,7	Heating temperatures .....	9,11,12,13	Set heating temperatures .....	13
Blinking display .....	6	Hold temperature .....	15	Setting limits .....	11,12
Canceling programs .....	15	MORNING .....	13,14	Sunday program .....	10,11,12,13,14
Change temperature .....	15	NIGHT .....	13,14,15	System switch .....	29
Checking current setting .....	15	Operation .....	15	Switch, fan .....	28
Clock display .....	19	Period keys .....	9	Switch, system .....	29
Conventional Recovery .....	7,8	Personal programming chart .....	11,12	Table of Contents .....	1
Cooling temperatures .....	9,11,12,14	Preprogrammed schedule .....	9,10,11,12	Temporary program changes .....	15
Current setting .....	15	Programming steps .....	13,14	Time .....	13
Customer Assistance .....	35	Replacing batteries .....	6,7	Time period .....	9,10,11,12
Day .....	13	Saturday program .....	10,11,12,13,14	Troubleshooting .....	30,31,32,33
DAYTIME .....	13,14,15	Set cooling temperatures .....	14	Warranty .....	36
Energy-saving temperature .....	9	Set present day .....	13	Weekday program .....	9,10,11,13,14
EVENING .....	13,14,15	Set present time .....	13		
Fan operation switch .....	20				

## Toll-free Customer Assistance

For all questions concerning this thermostat, please read and follow the instructions. If additional assistance is needed, call Honeywell Customer Assistance toll-free at 1-800-468-1502, Monday-Friday, 7:00 a.m. - 5:30 p.m., Central time.

Before you call, please have the following information available—thermostat model number and date code, type of heating/cooling system (e.g., hot water, warm air, oil, gas, etc.), and number of wires connected to the thermostat.

**NOTICE:** This equipment is a Class B digital apparatus, which complies with Canadian Radio Interference Regulations, CRC c.1374.

35

69-0733—3

## Limited One-Year Warranty

Honeywell warrants this product, excluding battery, to be free from defects in the workmanship or materials, under normal use and service, for a period of one (1) year from the date of purchase by the consumer. If, at any time during the warranty period, the product is defective or malfunctions, Honeywell shall repair or replace it (at Honeywell's option) within a reasonable period of time.

If the product is defective,

- (i) return it, with a bill of sale or other dated proof of purchase, to the retailer from which you purchased it, or
- (ii) package it carefully, along with proof of purchase (including date of purchase) and a short description of the malfunction, and mail it, postage prepaid, to the following address:

Honeywell Inc.  
Return Goods Department  
1050 Berkshire Lane  
Plymouth, MN 55441-4437

in Canada: Honeywell Limited/Honeywell Limitee  
Product Services ON30  
155 Gordon Baker Road  
North York, Ontario M2H 3N7

This warranty does not cover removal or reinstallation costs. This warranty shall not apply if it is shown by Honeywell that the defect or malfunction was caused by damage which occurred while the product was in the possession of a consumer.

Honeywell's sole responsibility shall be to repair or replace the product within the terms stated above. HONEYWELL SHALL NOT BE LIABLE FOR ANY LOSS OR DAMAGE OF ANY KIND, INCLUDING ANY INCIDENTAL OR CONSEQUENTIAL DAMAGES RESULTING, DIRECTLY OR INDIRECTLY FROM ANY BREACH OF ANY WARRANTY, EXPRESS OR IMPLIED, OR ANY OTHER FAILURE OF THIS PRODUCT. Some states do not allow the exclusion or limitation of incidental or consequential damages, so this limitation may not apply to you.

THIS WARRANTY IS THE ONLY EXPRESS WARRANTY HONEYWELL MAKES ON THIS PRODUCT. THE DURATION OF ANY IMPLIED WARRANTIES, INCLUDING THE WARRANTIES OF MERCHANTABILITY AND FITNESS FOR A PARTICULAR PURPOSE, IS HEREBY LIMITED TO THE ONE YEAR DURATION OF THIS WARRANTY. Some states do not allow limitations on how long an implied warranty lasts, so the above limitation may not apply to you.

This warranty gives you specific legal rights, and you may have other rights which vary from state to state.

If you have any questions concerning this warranty, please write our Customer Assistance Department, Honeywell Inc., 1885 Douglas Dr. N., Golden Valley, MN 55422-3992, or call 1-800-468-1502, Monday-Friday, 7:00 a.m. to 5:30 p.m., Central time. In Canada, write Retail Products ON30 Honeywell Limited/Honeywell Limitee, 155 Gordon Baker Road, North York, Ontario M2H 3N7.

36

69-0733—3