

# Honeywell

---

# Honeywell/20 Programmable Thermostat

## OWNER'S GUIDE

Weekday/Weekend (5-day/2-day)  
Programmable Heat and/or Cool  
Low Voltage (20 to 30 Vac)  
Thermostat and Mounting Plate  
Model CT2095



69-1385

Welcome to the world of comfort and energy savings with your new Honeywell Programmable Thermostat.

Your new thermostat will automatically control the temperature in your home, keeping you comfortable while saving energy when programmed according to the instructions in this manual.

Direct any questions concerning the application of this thermostat to Honeywell Consumer Services at 1-800-468-1502, Monday-Friday, 7:00 a.m.-5:30 p.m., Central time.



## MERCURY NOTICE

If this thermostat is replacing a thermostat that contains mercury in a sealed tube, do *not* place your old thermostat in the trash. Dispose of properly.

Contact your local waste management authority for instructions regarding recycling and the proper disposal of your old thermostat. If you have questions, call Honeywell Customer Response Center at 1-800-468-1502.

**Typical location of a mercury switch in a thermostat.**

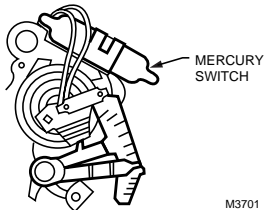

## Contents

Step 1. Prepare for Installation .....	4
Step 2. Remove Old Thermostat .....	6
Step 3. Install Batteries .....	8
Step 4. Program Thermostat .....	11
Step 5. Adjust Fan Operation Switch, As Required .....	19
Step 6. Adjust System On-Time, °F/°C, As Required .....	19
Step 7. Mount Thermostat Mounting Plate .....	21
Step 8. Wire Thermostat Terminals .....	23
Step 9. Mount Thermostat .....	27
Step 10. Check Thermostat Operation After Programming and Installing .....	28
Step 11. Set Fan and System Switches .....	30
Troubleshooting Guide .....	31
Limited One-Year Warranty .....	35

# Step 1. Prepare for Installation

- ❑ Check Table 1 to make sure this thermostat is compatible with your system. If not, return it to the retailer. For more information, call Honeywell Consumer Services, 1-800-468-1502, Monday - Friday, 7 am to 5:30 pm, Central time.

**Table 1. Compatibility Information.**

<b>System Type</b>	<b>Compatible with CT2095</b>
Gas—Standing Pilot	Yes
Gas—Electronic Ignition	Yes
Gas-Fired Boilers	Yes <sup>a,b</sup>
Gas—Millivolt	No
Oil-Fired Boilers	Yes <sup>a,b</sup>
Oil-Fired Furnace	Yes
Electric Furnace	Yes
Electric Air Conditioning	Yes
Baseboard Electric (120/240 Line Volt)	No
Heat Pumps/Multistage Equipment	No

Not compatible with any 120/240 volt circuit.

<sup>a</sup> Compatible with Honeywell 2-wire zone valves. Isolating relay required for 3-wire thermostats for zone valves. Not compatible with 2-wire White-Rodgers no. 1361 valves.

<sup>b</sup> Compatible with hot water baseboard systems. Does not work efficiently on steam or gravity systems.

- Acquire tools and items as needed (see illustration). Also purchase two AA alkaline batteries; we recommend Energizer® batteries.

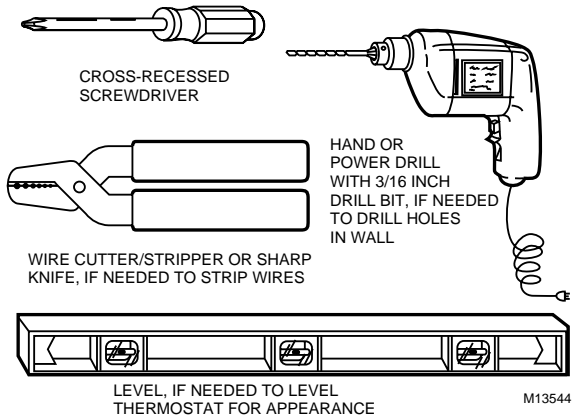

## Step 2. Remove Old Thermostat

- ❑ Test to be sure your heating and cooling systems are working properly. If either does not work, contact your local heating/air conditioning dealer. To avoid compressor damage, do not operate the cooling system when outdoor temperature is below 50°F (10°C).
- ❑ *Turn off power* to the system at the furnace, or at the fuse/circuit breaker panel.
- ❑ Carefully unpack your new thermostat and mounting plate, saving package of screws, instructions and receipt.
- ❑ Remove cover from old thermostat. If it does not snap off when pulled firmly from the bottom, check for a screw used to lock on the cover.

- ❑ Loosen screws holding thermostat to subbase, wallplate or wall, and lift away.
- ❑ Disconnect wires from old thermostat or subbase. As you disconnect each wire, attach one of the enclosed labels to each old terminal designation. If there are only two wires, they do not need labeling. If there is an extra wire that is not connected to your old thermostat, you also do not connect it to your new thermostat. Keep the wires from falling back into the wall by wrapping them around a pencil as shown.

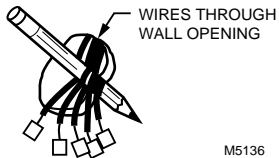

M5136

## Replacing a Clock Thermostat that has C or C1 Clock Terminals?

If you are replacing a Honeywell Chronotherm® Thermostat, you may find one or two wires that go to the C or C1 clock terminals on the Chronotherm® Thermostat wiring wallplate. Do not allow them to touch, or you can damage your transformer. Disconnect the wires and wrap them separately, using electrical tape. *Do not wrap them together.* Place the wires where they do not interfere with the operation of the new thermostat. Record the colors and terminal designation labels of the remaining wires.

## Six or more wires?

If there are six or more wires (excluding clock wires attached to terminals), you probably have a variation of a heat pump or multistage system. This thermostat is *not* compatible with

those systems so return the product to the retailer. If you want information about the programmable thermostats that work with your system, call Honeywell Consumer Services at 1-800-468-1502.

## Three thermostat wires?

If you have three wires for heating only and can operate the fan using the fan On switch, this thermostat works with your system. However, some hot water (zoned) heating systems have three thermostat wires. The thermostat does not work without installing an isolating relay on these systems. For details, call Honeywell Consumer Services at 1-800-468-1502.

## Step 3. Install Batteries

### **IMPORTANT**

*Batteries must be installed for the programming and operation of the thermostat and heating/cooling system.*

- ❑ Purchase two AA alkaline batteries; non-alkaline batteries do not last as long, and can leak, causing damage to the thermostat or the wall surface. We recommend Energizer® batteries.
- ❑ Open the top cover of thermostat to access control panel and battery compartment.
- ❑ Make sure the thermostat is set to the Off position.
- ❑ Use a coin to remove the battery cover.

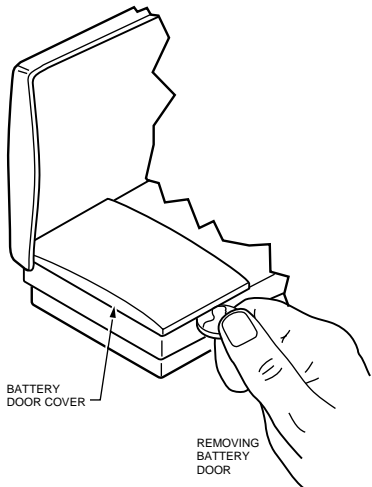

M12492



- ❑ Install the fresh batteries as shown, making sure positive and negative terminals are oriented correctly.
- ❑ Replace the battery cover.

As the batteries run low, a bAt Lo indicator flashes for one to two months before the batteries run out completely. Replace the batteries as soon as possible after the indicator starts flashing. If you do not replace the batteries sometime during the flashing bAt Lo, the indicator eventually stops flashing. bAt Lo then stays on without flashing, indicating the thermostat and heating/cooling system have stopped working and the batteries are almost completely dead.

After the batteries are completely dead, the bAtLo indication disappears, leaving a completely blank display.

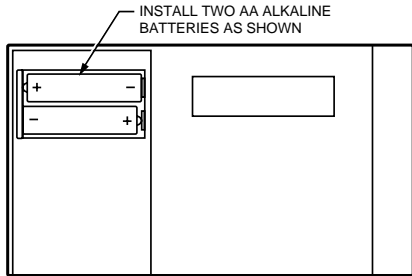

M1713

Press down on the left ends of batteries to remove them. If you insert the new batteries within 20 to 30 seconds of removing the old ones, you do not need to reprogram the thermostat. However, if the display is blank, the batteries are dead or incorrectly installed and you must reprogram. See Step 4.

### **IMPORTANT**

*Although the thermostat has a low battery indicator, replace the batteries once a year to prevent the thermostat and heating/cooling system from shutting down due to lack of battery power.*

*As a precaution, when leaving home for longer than a month, change batteries before you leave to prevent the system from shutting down due to lack of battery power.*

## Step 4. Program Thermostat

After the batteries are installed, the thermostat can be easily programmed in your hand before it is installed on the wall.

If you prefer to program the thermostat after it is installed on the wall, go to Step 7 and return later to this programming section.

The Personal Programming Chart, Tables 2 and 3, may be helpful for planning your program schedule of time and temperature settings for various times of the day.

Four time periods are available during weekdays — WAKE, LEAVE, RETURN, and SLEEP; view these periods individually on the display as you press the Weekday key.

- WAKE is the time period you want the house at a comfortable temperature when you get up and while you get ready for work or school. (This is a higher temperature during heating season and a lower temperature during cooling season.)
- LEAVE is the time period you can set for an energy-saving temperature while you are away at work or school. (This is a lower temperature during heating season and a higher temperature during cooling season.)
- RETURN is the time period you want the house at a comfortable temperature for activities before bedtime. (This is a higher temperature during heating season and a lower temperature during cooling season.)
- SLEEP is the time period you can set for an energy-saving temperature while you are sleeping. (This is a lower temperature during the heating season and a higher temperature during the cooling season.)

Set one schedule for weekdays and another for weekends because your requirements are usually different for each. Also, during weekends, only the WAKE and SLEEP time periods are available.

Fill in the times and temperatures you desire for weekdays and weekends. If you decide not to program the thermostat, it automatically controls heating at 68°F (20°C), and cooling at 78°F (26°C), 24 hours a day. Also, you do not need to enter a time and temperature program for all periods if your schedule does not require it. For example, a house that is occupied during weekdays would require programs only for WAKE and SLEEP.

If no program is entered for the weekends, the thermostat operates on the weekday SLEEP program all weekend.

Before programming, remove the clear plastic overlay covering the display.

When pressing the keys, use the ball of your finger or a soft pencil eraser. Using sharp fingernails or pencil points can damage the keypad.

If you make an error at any time during programming, just press the Run Program key, and continue again at the previous step in your sequence.

**Table 2. Personal Programming Chart for Heating.**

<b>Days of Week</b>	<b>Heating Program Start Time</b>	<b>Heating Temperature<sup>a</sup></b>
<b>Weekdays</b>		
WAKE		
LEAVE		
RETURN		
SLEEP		
<b>Weekends<sup>b</sup></b>		
WAKE		
SLEEP		

<sup>a</sup> The temperatures cannot be set any higher than 88°F (31°C) or any lower than 45°F (7°C).

<sup>b</sup> If you decide not to enter weekend programs, the thermostat operates on the weekday SLEEP program all weekend.

**Table 3. Personal Programming Chart for Cooling.**





Days of Week	Cooling Program Start Time	Cooling Temperature <sup>a</sup>
<b>Weekdays</b>		
WAKE		
LEAVE		
RETURN		
SLEEP		
<b>Weekends<sup>b</sup></b>		
WAKE		
SLEEP		

<sup>a</sup> The temperatures cannot be set any higher than 88°F (31°C) or any lower than 45°F (7°C).

<sup>b</sup> If you decide not to enter weekend programs, the thermostat operates on the weekday SLEEP program all weekend.



**NOTE:** Batteries are required for operation and programming. When inserting batteries, set the System switch to Off. Remove the battery door (on the thermostat left side) using a coin at the bottom. Follow instructions in Step 3. Also see the label inside the battery cover for abbreviated programming procedures for your thermostat.

## Set Current Time/Day

To set time, press and release  once, press  until current shows. To set day, press and release  again, press  until current day shows; then press  .

## Heating Program

With System switch at Heat, press and release  once. WAKE, MON FRI (Monday-Friday), and SET appear on display.

Use  to program WAKE time and  to program WAKE temperature for MON FRI (Monday-Friday). Repeat sequence for LEAVE, RETURN, SLEEP.

Press <sup>Weekend</sup> 0 until SAT SUN (Saturday-Sunday), WAKE and SET appear on display. Use <sup>Time</sup> (+) to program WAKE time and <sup>TEMP</sup> (▲▼) to program WAKE temperature for SAT SUN (Saturday-Sunday). Repeat sequence for SLEEP. Press and release <sup>Run Program</sup> 0 to start the program.

## Cooling Program



With System switch at Cool, follow the same instructions as for the Heating Program.



After programming, adjust the Fan and System switches, as desired. Press and release <sup>Run Program</sup> 0 to start the program.





## Operating Your Thermostat

System switch must be set to Heat or Cool to perform the following:

**Temporarily Change Temperature** *for current period only* — Press ; temporary indicator shows  on display and cancels itself at the next scheduled change; to cancel sooner, press .

**Hold a Temperature Indefinitely** (such as when on vacation) — Press  and ; HOLD appears on display; to cancel, press .

**Check Current Temperature Setting** — Press .

**Check Programs** — Press ,  repeatedly to see each time and temperature; then press .

**Cancel Program** — Press <sup>Weekday</sup> 0 , <sup>Weekend</sup> 0 until program to cancel shows; then press <sup>Clear</sup> 0 .

**Check Usage** — Press <sup>Usage</sup> 0 to see length of time heat or air conditioning has run today since midnight; press again for yesterday's usage, press again for cumulative; press <sup>Clear</sup> 0 to clear cumulative reading, if desired; then press <sup>Run Program</sup> 0 .

**Permanently Change a Program** — Repeat Heating Program or Cooling Program steps, as applicable.

**Return to Normal Program or Start Program** — Press <sup>Run Program</sup> 0 .

## Step 5. Adjust Fan Operation Switch, As Required

- ❑ The thermostat fan operation switch, labeled FUEL SWITCH (see illustration) is factory-set in the F position. This is the correct setting for most systems. If your system is an electric heat system, set the switch to E to allow the fan to turn on immediately with the heating in a system when the G terminal is connected.

## Step 6. Adjust System On-Time, °F/°C, As Required

- ❑ The thermostat on-time is factory-set for a warm air, gas or oil heating system. If you are installing it on another type of system, adjust the on-time accordingly by setting screws A and B on the back of the thermostat. Use the heating system table shown in the illustration

as a guide. The system on-time should be optimized according to the type of system to maximize comfort. Setting the screw “out one turn” means turning the screw approximately 360° counterclockwise, or about one complete turn.

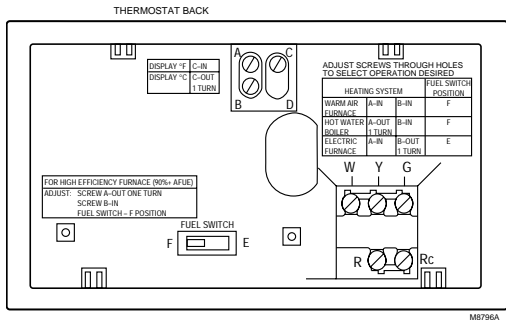

In the unlikely event that you want a longer furnace on-time, readjust screws A and/or B as follows:

First, turn both screws in completely, then adjust for system type:

- Warm Air Furnace—Set at the Hot Water setting (A—out one turn, B—leave in).
- Electric Furnace—Leave at the Warm Air Furnace setting (A—leave in, B—leave in).

**NOTE:** This thermostat does not have a setting for steam/gravity air; cycles would not be long enough for accurate temperature control.

### **IMPORTANT**

*When using a high efficiency furnace such as a 90 percent or greater Average Fuel Utilization Efficiency (AFUE) unit, adjust screw A out one turn and leave screw B in.*

- ❑ The thermostat is set to read the temperature in degrees Fahrenheit. If readings are desired in degrees Celsius, adjust screw C out one turn.

## Step 7. Mount Thermostat Mounting Plate

- ❑ Position mounting plate on wall. Use level to make sure mounting plate is level. Use a pencil to mark the two mounting holes.
- ❑ Remove mounting plate from wall, and drill 3/16-inch holes in wall (if drywall) as marked. For firmer material such as plaster or wood, drill 7/32-inch holes. Gently tap anchors (provided) into drilled holes until flush with the wall.
- ❑ Reposition mounting plate over holes, pulling wires through wiring opening.
- ❑ Loosely insert two mounting screws into holes.

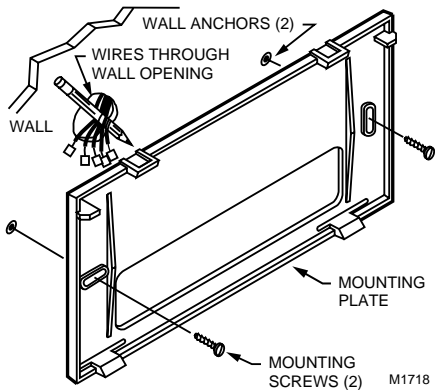

- ❑ Level for appearance only; thermostat functions properly even when not level.
- ❑ Tighten mounting screws.

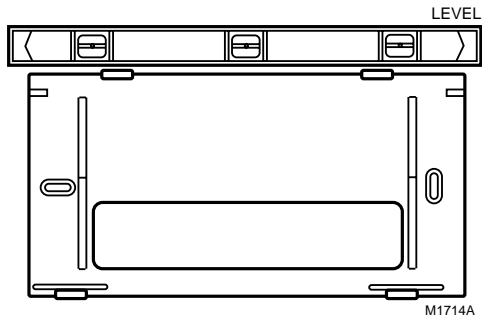

## Step 8. Wire Thermostat Terminals

**NOTE:** All wiring must comply with local codes and ordinances. If unsure about household wiring procedures, call your local heating/air conditioning contractor.

- ❑ Refer to the labels you placed on the terminal wires when you removed your old thermostat. Match the letter of your old thermostat wire with the terminal of the corresponding letter on the back of your new thermostat. (See wiring diagrams.) Hold the thermostat as shown in illustration to minimize need for wire extenders. If wires are still too short, use wire connectors (purchased locally) to extend wires. See illustration for guidelines on using wire extenders.

METHOD TO INCREASE WIRE LENGTH

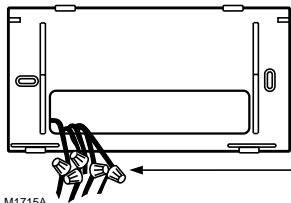

WIRE NUT SIZE FOR TWO 18-GAUGE WIRES

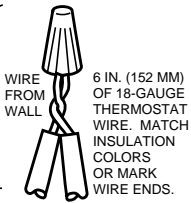

- ❑ In 5-wire installations only, be sure to remove the factory-installed jumper connecting terminals R and Rc.

- ❑ Loosen the terminal screws and slip each wire beneath its matching terminal. See illustrations for wire insertion technique.
- ❑ Securely tighten terminals.
- ❑ Plug the hole in the wall with insulation to help prevent drafts from adversely affecting thermostat operation.

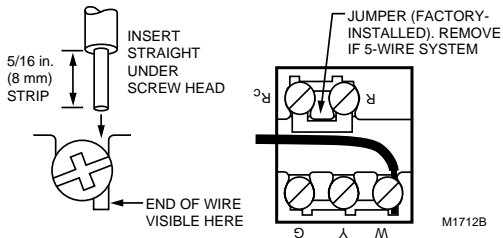
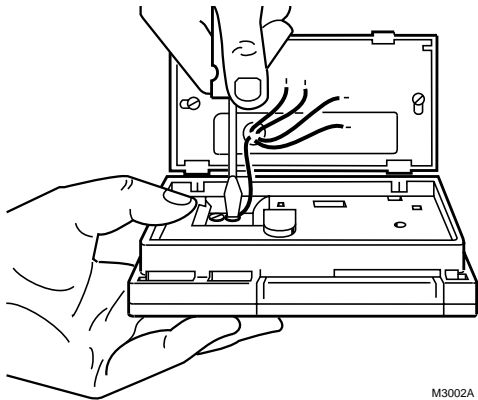



### 2-WIRE HEAT-ONLY (JUMPER INTACT)

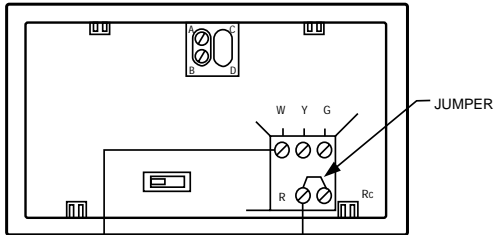

HEATING  
RELAY OR  
VALVE COIL

L1  
(HOT)  
L2

1 POWER SUPPLY. PROVIDE DISCONNECT MEANS AND OVERLOAD PROTECTION AS REQUIRED.

M1709B

### 4-WIRE HEAT/COOL (JUMPER INTACT)

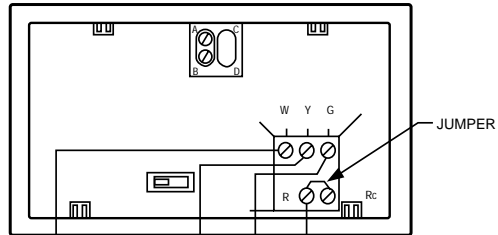

HEATING  
RELAY OR  
VALVE COIL

COOLING  
CONTACTOR  
COIL

FAN  
RELAY

L1  
(HOT)  
L2

1 POWER SUPPLY. PROVIDE DISCONNECT MEANS AND OVERLOAD PROTECTION AS REQUIRED.

M1710B

### 5-WIRE HEAT/COOL (JUMPER REMOVED)

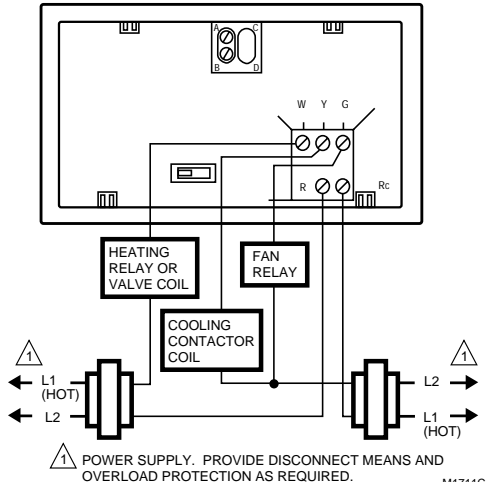

### 3-WIRE COOL-ONLY (JUMPER INTACT)

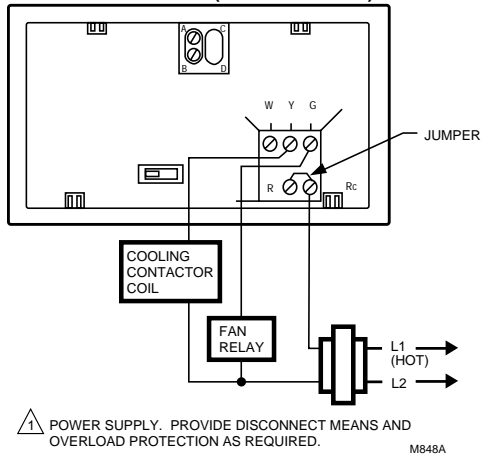

## Step 9. Mount Thermostat

**NOTE:** To remove thermostat from wall, first pull out at bottom of thermostat, then remove top.

**A.** ENGAGE TABS AT TOP OF THERMOSTAT AND SUBBASE.

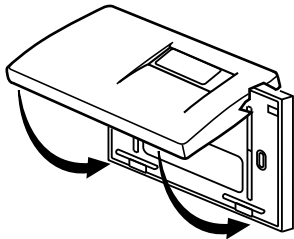

**B.** PRESS LOWER EDGE OF CASE TO LATCH.

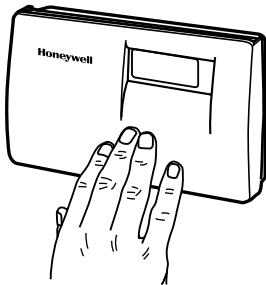

**C.** SWING OPEN COVER TO CHECK OPERATION.

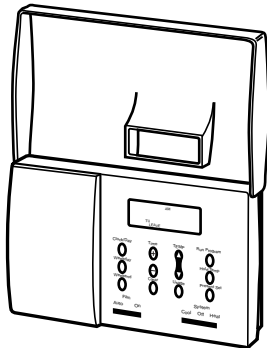

M13545

## Step 10. Check Thermostat Operation After Programming and Installing

### Heating

Do *not* check heating system operation by jumpering thermostat terminals such as gas valve, zone valve, and oil burner control at the primary control. This damages the thermostat. Instead, jumper R and W wires at the thermostat.

Move the System switch to Heat and the Fan switch to Auto.

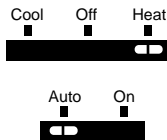

Press TEMP key until the setting is about 10°F (6°C) above room temperature. Heating should start and the fan should run after a short delay (immediately if fan operation switch is set to E position).



Press TEMP key until setting is about 10°F (6°C) below room temperature. The heating equipment should shut off.

## Cooling

To avoid possible compressor damage, do not operate the cooling system when outdoor temperature is below 50°F (10°C). See compressor manufacturer instructions.

### **IMPORTANT**

*When cooling setting is changed, thermostat delays up to five minutes before turning on the air conditioner. This delay protects the compressor.*

Move the System switch to Cool and the Fan switch to Auto.

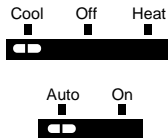

Press TEMP key until setting is about 10°F (6°C) below room temperature. The cooling equipment and fan should start.



Press TEMP key until the setting is about 10°F (6°C) above room temperature. The cooling equipment and fan should stop.

Move the System switch to Off; keep the Fan switch at Auto. The system and fan should be off.

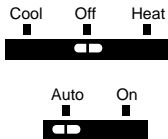

## Step 11. Set Fan and System Switches

### First set the Fan switch.

Fan Auto: Normal setting for most homes. A single-speed fan will turn on automatically with the air conditioner or furnace. A two-speed fan usually runs on high with the air conditioner and on low with the furnace.

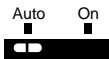

Fan On: The fan runs continuously. Use for improved air circulation during special occasions or for more efficient electronic air cleaning. (In a heat-only system, fan runs continuously only if fan relay is connected to the thermostat.)

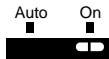

### Then set the System switch.

Cool: The thermostat controls your air conditioning system.

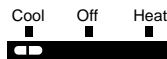

Off: Both the heating and air conditioning systems are off.

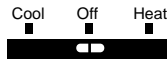

Heat: The thermostat controls your heating system.

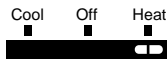

## Troubleshooting Guide

If...	Then...
Display does not come on.	Set the System switch to Off. Remove batteries. Insert them backward for at least five seconds to reset the thermostat. Replace batteries correctly. Display should come on. Make sure batteries are fresh and installed correctly.
Temperature display does not go lower than 45°F (7°C) or higher than 88°F (31°C) during programming.	You have reached the temperature setting limit. The setting range is 45°F to 88°F (7° to 31°C).
Temperature change occurs at wrong times.	Check the program times for the questionable period. Be sure that AM and PM indications are correct. Make sure the current day and time are correct. Reprogram, if necessary.

<b>If...</b>	<b>Then...</b>
Heating does not come on.	Check that the System switch is set to Heat.
	Make sure the heating setpoint is above the room temperature.
	Check the system fuse or circuit breaker and replace or reset, if necessary.
	Make sure the System switch is in the On position; set it to On if it is in the Off position.
	If temperature setting is higher than the current temperature and the display says HEAT, contact Honeywell Consumer Services at 1-800-468-1502.
Cooling does not come on.	Check that the System switch is set to Cool.
	Make sure the cooling setpoint is below the room temperature.
	Check the system fuse or circuit breaker and replace or reset, if necessary.
	Make sure the System switch at the air conditioner is in the On position; set it to On if it is in the Off position.



If...	Then...
Cooling does not come on (Continued).	The thermostat has a built-in time delay on cooling. Allow five to ten minutes after changing the setting before the air conditioner starts.
	If temperature setting is lower than current temperature, and the display says COOL, move the System switch from Cool to Off for ten minutes. After ten minutes, return the switch to the Cool position. If air conditioner comes on, compressor may have reached its high-limit temperature protection and shut down. If air conditioner does not come on after the ten minutes and the display says COOL, contact Honeywell Consumer Services at 1-800-468-1502.
	If two- or four-wire installation, verify R-Rc jumper is installed.
The house is too warm or too cool.	Press Present Set key to check the current temperature setting.
	If desired, change the temperature setting. See Cooling Program section.
SYSTEM ON indicator is lighted, but no heat is coming from the registers.	Allow time for the furnace to heat up and the fan to come on before checking for heat at the register. (Check to make sure system on-time is set correctly. See Step 6.)

## **Toll-free Customer Assistance**

For all questions concerning this thermostat, please read and follow the instructions. If additional assistance is needed, call Honeywell Consumer Services at 1-800-468-1502, Monday - Friday, 7:00 a.m. - 5:30 p.m. Central time.

Before you call, please have the following information available—thermostat model number and date code, type of heating/cooling system (hot water, warm air, oil, gas, etc.), and number of wires connected to the thermostat.

### **NOTICE**

This equipment is a Class B digital apparatus, which complies with Canadian Radio Interference Regulations, CRC c.1374.

## Limited One-Year Warranty

Honeywell warrants this product, excluding battery, to be free from defects in the workmanship or materials, under normal use and service, for a period of one (1) year from the date of purchase by the consumer. If, at any time during the warranty period, the product is defective or malfunctions, Honeywell shall repair or replace it (at Honeywell's option) within a reasonable period of time.

If the product is defective,

- (i) return it, with a bill of sale or other dated proof of purchase, to the retailer from which you purchased it, or
- (ii) package it carefully, along with proof of purchase (including date of purchase) and a short description of the malfunction, and mail it, postage prepaid, to the following address:

Honeywell Inc.  
Return Goods Department  
1050 Berkshire Lane  
Plymouth, MN 55441-4437

Canada: Honeywell Limited/Honeywell Limitée  
Product ServicesON15-FFE  
740 Ellesmere Road  
Scarborough, Ontario M1P 2V9

This warranty does not cover removal or reinstallation costs. This warranty shall not apply if it is shown by Honeywell that the defect or malfunction was caused by damage which occurred while the product was in the possession of a consumer.

Honeywell's sole responsibility shall be to repair or replace the product within the terms stated above. HONEYWELL SHALL NOT BE LIABLE FOR ANY LOSS OR DAMAGE OF ANY KIND, INCLUDING ANY INCIDENTAL OR CONSEQUENTIAL DAMAGES RESULTING, DIRECTLY OR INDIRECTLY, FROM ANY BREACH OF ANY WARRANTY, EXPRESS OR IMPLIED, OR ANY OTHER FAILURE OF THIS PRODUCT. Some states do not allow the exclusion or limitation of incidental or consequential damages, so this limitation may not apply to you.

THIS WARRANTY IS THE ONLY EXPRESS WARRANTY HONEYWELL MAKES ON THIS PRODUCT. THE DURATION OF ANY IMPLIED WARRANTIES, INCLUDING THE WARRANTIES OF MERCHANTABILITY AND FITNESS FOR A PARTICULAR PURPOSE, IS HEREBY LIMITED TO THE ONE YEAR DURATION OF THIS WARRANTY. Some states do not allow limitations on how long an implied warranty lasts, so the above limitation may not apply to you.

This warranty gives you specific legal rights, and you may have other rights which vary from state to state.

If you have any questions concerning this warranty, please write our Customer Assistance Center, Honeywell Inc., P.O. Box 524, Minneapolis, MN 55440-0524 or call 1-800-468-1502, Monday-Friday, 7:00 a.m. to 5:30 p.m., Central time. In Canada, write Retail Products ON15-02H, Honeywell Limited/Honeywell Limitée, 155 Gordon Baker Road, North York, Ontario M2H 2C9.

## TYPICAL ENERGY SAVINGS FOR REPRESENTATIVE CITIES IN THE U.S. AND CANADA

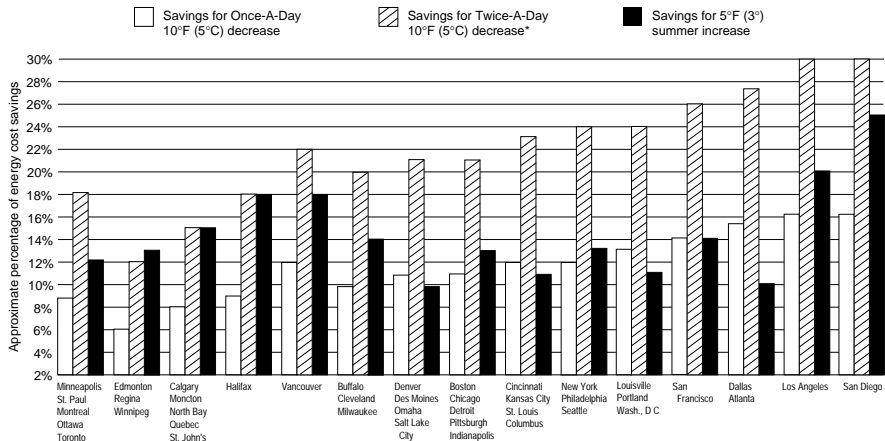

\*Based on 10°F (5°C) decrease—(5°F [3°C] decrease gives approximately 55 percent of these savings).

M2416A





# Honeywell

---

**Home and Building Control**

Honeywell Inc.  
Honeywell Plaza  
P.O. Box 524  
Minneapolis, MN 55408-0524

69-1385 G.H. 6-00

**Home and Building Control**

Honeywell Limited-Honeywell Limitée  
155 Gordon Baker Road  
North York, Ontario  
M2H 3N7



Printed in U.S.A. on recycled  
paper containing at least 10%  
post-consumer paper fibers.

[www.honeywell.com/yourhome](http://www.honeywell.com/yourhome)