

CT1800, CT1801, CT1802 Electromechanical Fuel Saver Thermostat and Wallplate/Subbase

Installation Instructions

- CT1800 24V gas or oil heat, or 3 wire zone valves.
- CT1801 24V gas or oil heat/cool.
- CT1802 24V central electric heat/cool or single stage heat pump without auxiliary heat.

Not for use on line voltage (120V) millivolt systems.

Recycling Notice



This control contains mercury in a sealed tube. Do *not* place control in the trash at the end of its useful life.

If this control is replacing a control that contains mercury in a sealed tube, do *not* place your old control in the trash.

Contact your local waste management authority for instructions regarding recycling and the proper disposal of this control, or of an old control containing mercury in a sealed tube.

THERMOSTAT FEATURES

I—Front of thermostat.

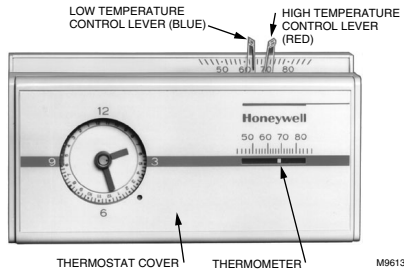

II—Hinged cover lifted.

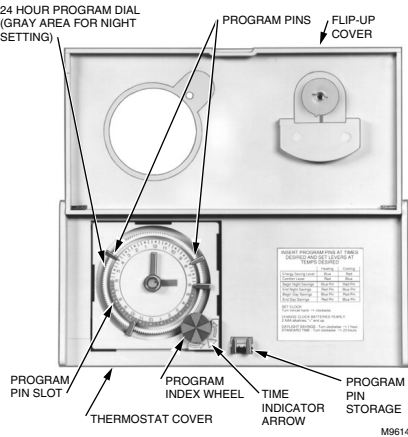

III—Cover removed.

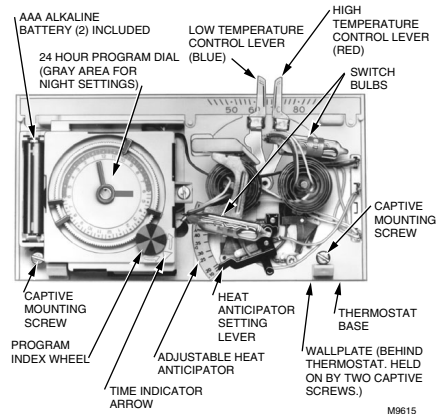

1 PREPARATION

- Check thermostat and wallplate suitability for your heating or heating/cooling system. Refer to Table 1.

TABLE 1—THERMOSTAT AND SUBBASE APPLICATIONS.^a

Thermostat Model	Subbase Wallplate Included	For Use With
CT1800	199986B Wallplate	2- or 3- wire, 150 to 30 volt control circuit. For gas or oil heating system or 3-wire zone valve heating system.
CT1801	Q682A1079 Subbase	4- or 5- wire, 15-30 volt control circuit. For gas or oil heating/cooling system.
CT1802	Q682B1227 Subbase	4- wire, 15 to 30 volt control circuit. For single-stage heat pump without auxiliary heat or central electric heating/cooling systems that require the thermostat to control the fan in heating.

^a Thermostat must be mounted on wallplate or subbase included in package to assure operation.

- Assemble tools as required.

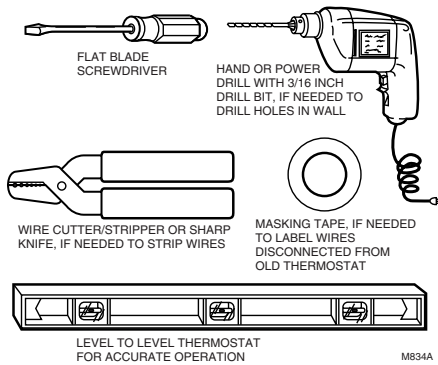

- If wallplate or subbase is mounted on a vertical outlet box (check old installation), order 196393A Cover Plate and Adapter Ring (see appropriate illustration in Step 4). To order check your telephone directory for your local Honeywell distributor.

- Test to make certain that your heating and cooling systems are working. If either one does not work, contact your local heating/air conditioning dealer.

NOTE: Do not operate cooling system if outdoor temperature is below 50°F (10°C)

- Turn off power to the heating/cooling system at the main fuse panel.

2 UNPACK THERMOSTAT

- Remove and discard shipping wrap. Save package of screws, instructions and receipt.
- Remove thermostat cover by lifting up from the bottom.
- Carefully remove insert protecting switch bulbs.
- Loosen two captive mounting screws, and separate wallplate or subbase from back of thermostat base.

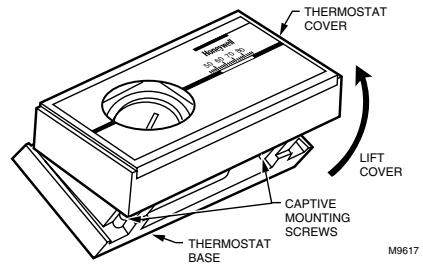

3 REMOVE OLD THERMOSTAT

- Remove cover of old thermostat. If the cover does not snap off when pulled firmly from the bottom, check for a screw that locks on the cover.

- Before removing the old thermostat from the wall, look at it carefully to locate the heat anticipator adjustment mechanism. (See illustration to help you

recognize the heat anticipator.) Make a note here of that anticipator setting for future reference. If your thermostat does not have a heat anticipator, do not be concerned. Move on to next paragraph.

- Loosen screws holding thermostat to wallplate, subbase or wall and lift away.

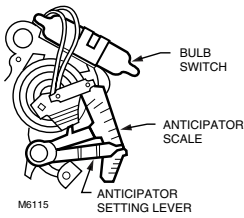

IMPORTANT: If old thermostat has B or O terminals, this thermostat cannot be used on your system.
EXCEPTION: The CT1802 Thermostat can be used on a system with B or O terminals.

One or two extra wires?

If you are replacing a Honeywell Chronotherm® Thermostat, you may find one or two wires that go to the clock terminals on the Chronotherm® Thermostat wiring wallplate. Do not allow them to touch, or you may damage your transformer. Disconnect the wires, and wrap them separately, using electrical tape. **Do not wrap them together.** Place the wires where they will not interfere with the operation of the new thermostat. Record the colors and terminal designation labels of the remaining wires.

Disconnect wires from old thermostat, wallplate or subbase. Tape each end and label with the letter of the terminal designation to make reconnection easier. If there are only two wires labeling is not necessary.

4 MOUNT WALLPLATE OR SUBBASE

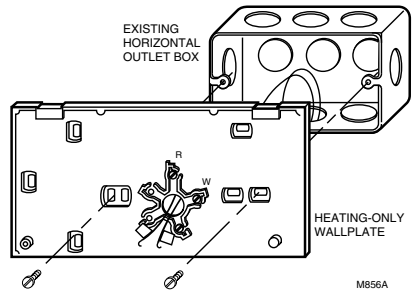
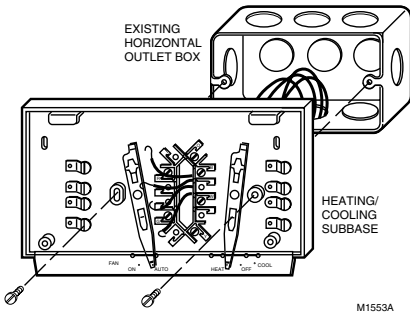

If mounting on outlet box, mount as shown in appropriate illustration.

Position wallplate or subbase as shown in appropriate figure, and loosely insert the screws supplied.

When mounting on wall, hold wallplate or subbase in position and mark holes on wall. Use level to make sure wallplate or subbase will be level. Drill 3/16 in. holes and gently tap anchors into holes until flush with the wall.

Carefully level the wallplate or subbase and firmly tighten screws.

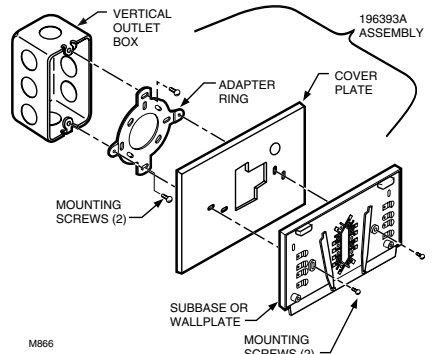
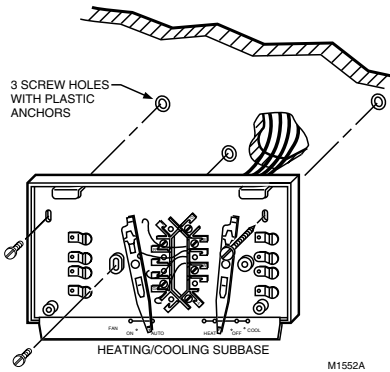

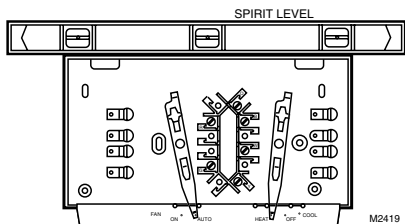
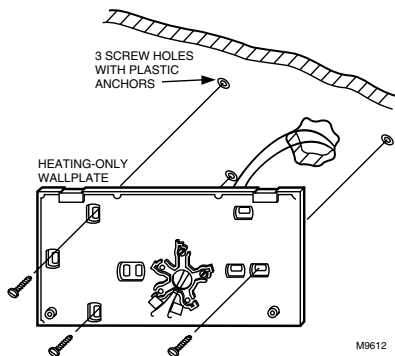

5 WIRE WALLPLATE OR SUBBASE

NOTE: All wiring must comply with local electrical codes and ordinances.

Refer to illustration and strip thermostat wire insulations as necessary.

FOR STRAIGHT CONNECTION—
STRIP 5/16 in. [8 mm]

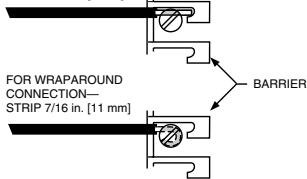

FOR CT1800 heating—only

For 2-wire system, connect either wire to R terminal and the other wire to W terminal. For 3-wire system, connect W wire to W terminal, R wire to R terminal, and remaining wire to B terminal. Firmly tighten screws.

Push excess wire back into wall, and plug hole in wall with nonflammable insulation to prevent drafts from affecting thermostat operation.

2-WIRE SYSTEM

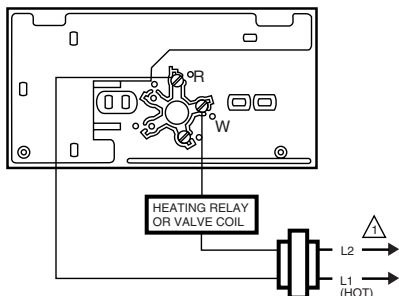

POWER SUPPLY. PROVIDE DISCONNECT MEANS AND OVERLOAD PROTECTION AS REQUIRED.

M2484B

3-WIRE SYSTEM

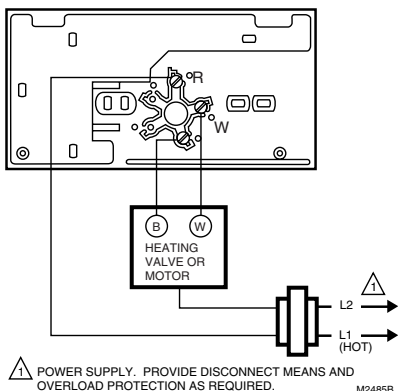

FOR CT1801 heating/cooling

Connect the wires to matching terminals on the subbase.

NOTE: If there are four wires, connect wire marked R to terminal RH and add a jumper wire to connect to RC. If RC is left unconnected, the air conditioner will not turn on. The 4-wire drawing on page shows how to jumper RC to RH. Strip the insulation off the wire where it connects to the terminals. Firmly tighten screws.

If the labels do not agree with the terminal designations on your new subbase:

- Refer to Table 2
- Determine correct hookup from the listed control function and the equipment control circuit.

Push excess wire back into wall, and plug hole in the wall with nonflammable insulation to prevent drafts from affecting thermostat operation.

4-WIRE SYSTEM

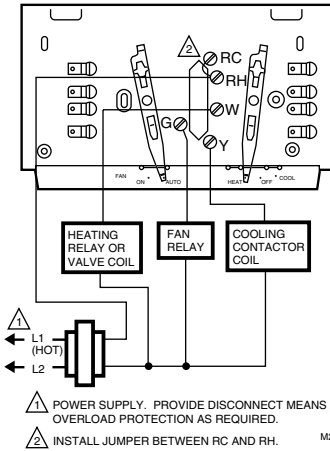

5-WIRE SYSTEM

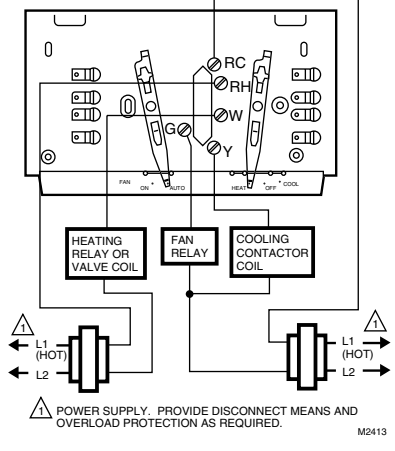

TABLE 2—TERMINAL DESIGNATIONS.

Subbase Terminal	Control Function
R or RH	Heating transformer power to control circuit
RX	Cooling transformer power to control circuit
W	Heating relay or valve
Y	Cooling relay
G	Fan relay
B	Heating changeover valve or damper control circuit
O	Cooling changeover valve or damper control circuit
P	Heat pump compressor control circuit.

FOR CT1802 heating/cooling

☐ Connect the wires to matching terminals on the subbase. Firmly tighten screws.

☐ Push excess wire back into wall, and plug hole in wall with nonflammable insulation to prevent drafts from affecting thermostat operation.

CENTRAL ELECTRIC SYSTEM

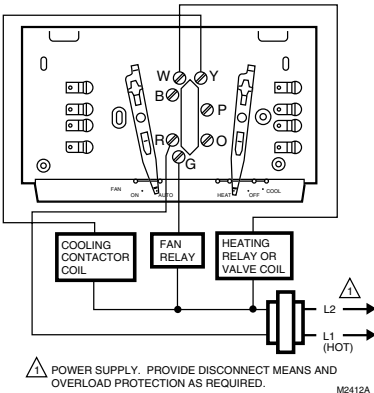

SINGLE STAGE HEAT PUMP (WITHOUT AUXILIARY HEAT) SYSTEM

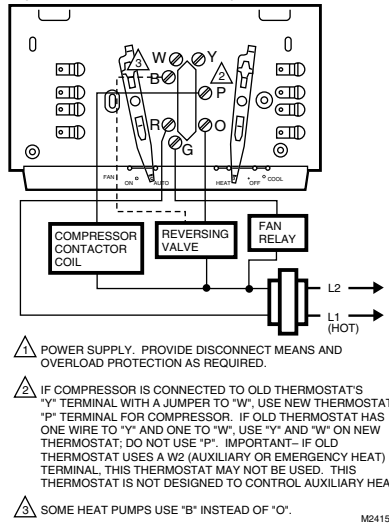

6 MOUNT THE THERMOSTAT

Note the tabs on the top inside edge of the thermostat base. These fit the slots molded into the top of the wallplate or subbase.

Hang the thermostat base on the wallplate or subbase as shown in illustration.

Insert the two captive mounting screws located in the bottom corners of the thermostat base (see illustration); firmly tighten.

IMPORTANT: Do not cycle heating system until step 7 is completed.

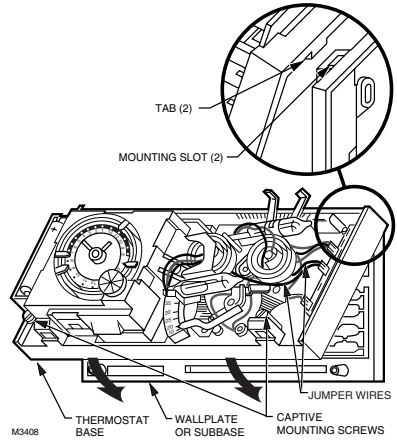

7 SET HEAT ANTICIPATOR LEVER

The thermostat adjustable heat anticipator must be correctly set to accurately control the on-time length of the system. An incorrect setting can result in room temperature swings or burn out the anticipator and void the thermostat warranty.

Make sure you have the current draw (anticipator setting) for your system. This is the number you wrote in the box in Step 3. If you were unable to find the current draw for Step 3, this information can be found printed on the primary control at the furnace or boiler. The primary control is usually a gas

valve, a relay or burner control box, Aquastat controller or zone valve with the thermostat wires connected to it. These controls are usually located behind the furnace cover. See next illustration.

If current rating is still unavailable, proceed as follows:

- Connect the probes of an ac ammeter (0 to 2.0A for example) between the R (or RH) and W terminals on the wallplate or subbase.
- Let the system operate through the ammeter for at least one minute before taking reading. Record the reading here .

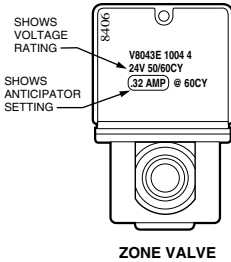

ZONE VALVE

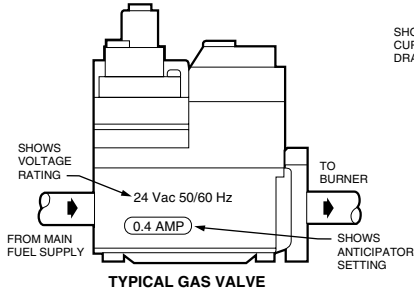

TYPICAL GAS VALVE

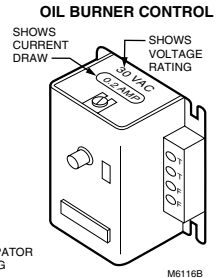

OIL BURNER CONTROL

Move the heat anticipator to match the number you recorded in Step 3 or found on the primary control as shown above, or as recorded in Step 7.

IMPORTANT: Most hot water systems require a setting of 1.3 times the valve current rating.

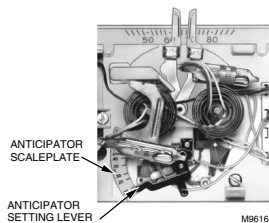

ANTICIPATOR SCALEPLATE
ANTICIPATOR SETTING LEVER

8 INSTALL CLOCK BATTERIES

Power is supplied to the clock by two AAA alkaline batteries (included). Install clock batteries in thermostat as shown. Once a year, or when batteries are dead, replace with two new AAA alkaline batteries. We recommend Energizer® batteries. Other types of batteries are more likely to leak, which could damage the clock. The thermostat itself will operate without batteries, but will not operate as a fuel saver.

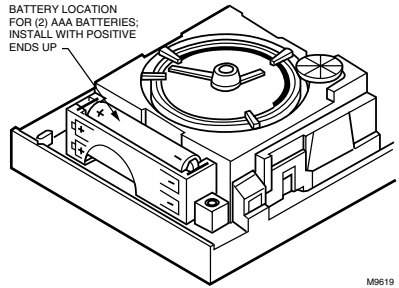

M8619

9 SET CLOCK

Adjust the clock by moving the minute hand in  clockwise direction. Do *not* reverse the minute hand.

When time is correctly set, the Time Indicator Arrow (see illustration) must point to the correct time and the corresponding daytime (light) or nighttime (dark) portion of the program dial.

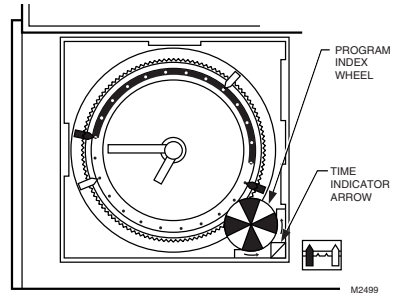

M2499

10 ATTACH THERMOSTAT COVER

- Make sure the packing inserts in the thermostat base have been removed, as explained in Step 2.
- Place the two tabs on upper edges of cover into the mounting slots in the thermostat base.
- Swing cover downward until it engages catch at bottom of base.

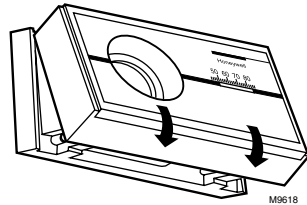

M9618

11 CHECKOUT THERMOSTAT OPERATION AND SET TEMPERATURE CONTROL LEVERS

The two levers on top of the thermostat control the low and high temperature for energy savings and comfort control as shown in the illustration.

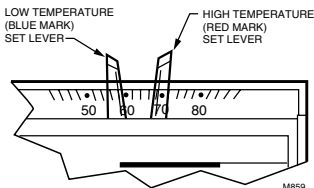

M859



CAUTION

Do *not* check operation by shorting across terminals of relay or valve coil; this will burn out the thermostat heat anticipator, which will void the warranty.

Heating-Only System

- Turn on power to the furnace.

Push both temperature control levers together at least 5°F (3°C) above room temperature. The heat should come on. The fan will start when the furnace heats up.

Move both levers 5°F (3°C) below room temperature. The heat should shut off.

Operate the entire heating system for at least one complete cycle.

IMPORTANT: *If thermostat fails any test, refer to the Troubleshooting Guide in Owner's manual.*

Heating/Cooling System

Turn on power to the furnace and cooling system.

Place the system switch lever at HEAT and the fan switch lever at AUTO.

Push both temperature control levers together at least 5°F (3°C) above room temperature. The heat should come on. The fan will start when the furnace heats up. On the CT1802, the fan will start immediately.

Move both levers together at 5°F (3°C) below room temperature. The heat should shut off. The fan will stop when the furnace cools.

IMPORTANT: *To avoid compressor damage, do not operate the cooling system if outdoor temperature is below 50°F (3°C) below room temperature. The heat should shut off. The fan will stop when the furnace cools.*

Place the system switch level at COOL and the fan switch lever at AUTO.

Push both temperature control levers together at least 5°F (3°C) below room temperature. The cooling equipment should operate, and the fan will start. Allow for any time delay that may be built into the compressor control circuit.

Move both levers together 5°F (3°C) above room temperature. The cooling equipment should shut off.

Place the fan switch at ON. The fan should run continuously with the system in any position.

Place the system switch at OFF. Move both temperature levers to various positions. The heating and cooling systems should not operate.

Operate the entire system for at least one complete cycle with the system switch at COOL and one complete cycle with the switch at HEAT.

IMPORTANT: *If thermostat fails any test, refer to troubleshooting guide in owner's manual.*

After checkout, reset both temperature levers to desired temperatures.

For heating season:

Move the *blue* lever to the *energy savings* temperature you want when you are sleeping or your home is not occupied.

Set the *red* lever to the temperature you want for *normal* comfort periods.

For cooling season:

Move the *red* lever to the *energy savings* temperature you want when you are sleeping or your home is not occupied.

Set the *blue* lever to the temperature you want for *normal* comfort periods.

Refer to the owner's manual form 69-0333 for operating and programming instructions.

If you have questions regarding the thermostat please visit our web site at www.honeywell.com/yourhome, or call the customer information line at 1-800-468-1502.

Honeywell

Helping You Control Your World

www.honeywell.com/yourhome