

**Configuration of Class 200 transmitters**

**Keypad**



**Air velocity**



< CTV210

**Pressure**



CP200 >

**Temperature  
Humidity**









TH200 >  
Remote probe



< TH200  
Standard probe





<b>1. Prerequisite</b> .....	P 1
1.a - Working principle .....	P 1
1.b - Output signal selection .....	P 1
1.c - Protection tip of the sensor .....	P 1
<b>2. Code activation and access to functions</b> .....	P 2
<b>3. Display and keypad configuration</b> •  F100 .....	P 3
3.a - Backlight .....	P 3
3.b - Display contrast control .....	P 3
3.c - Keypad locking .....	P 4
<b>4. Configuring channels and units of measurement</b> •  F200 .....	P 5
<b>5. Analogue output management</b> •  F300 .....	P 6
5.a - Output diagnostics .....	P 7
5.b - Analogue output settings .....	P 8
<b>6. Relay / Alarm settings</b> •  F400 .....	P 10
6.a - Activation / Deactivation of BEEP alarm .....	P 10
6.b - Relay security .....	P 10
6.c - Alarm/relay functions and LED colour codes .....	P 11
6.d - Channel selection for alarms/ relays .....	P 12
6.e - Alarm mode details .....	P 13
6.f - Alarm mode selection .....	P 15
6.g - Setpoints and time-delay setting .....	P 16
<b>7. Pressure measurement configuration</b> •  F500 .....	P 18
7.a - Pressure measurement integration (CP 200) .....	P 18
7.b - Autozero .....	P 18
<b>8. Humidity measurement configuration</b> •  F500 .....	P 19
8.a - Offset settings in Humidity and temperature (TH 200) .....	P 19
<b>9. Air velocity measurement configuration</b> •  F600 .....	P 20
9.a - Temperature compensation (CP 200) .....	P 20
9.b - Air velocity coefficient selection (CP 200) .....	P 21
9.c - Air velocity correction coefficient input (CP and CTV 210) .....	P 22



<b>10. Airflow measurement configuration</b> •  F600 .....	P 23
<b>11. Other functions</b> .....	P 26
11.a - Activation / Deactivation of the RS232 .....	P 26
11.b - Serial number display .....	P 26
11.c - Purge Mode .....	P 27
<b>12. Error codes</b> .....	P 30
<b>13. Functions recap</b> .....	P 31



## 1.a - Working principle

Using keypad, you can activate (or deactivate) a channel, change the measuring range, set the set points and time-delay...

**Principle:** the configuration options are accessed via **folders and sub-folders** (similar to Windows®). Access is made via a **numerical code** (full details in this manual).

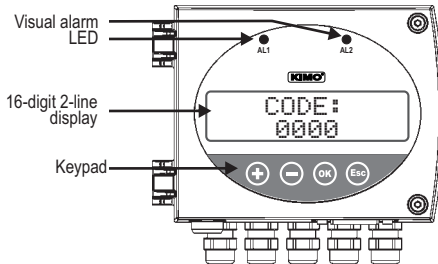

### ■ Meaning of the keys

- To increment a value or a level
- To decrement a value or a level
- To validate an input
- To cancel an input or to return to the previous step

## 1.b - Output signal selection

### Voltage or Current ?

The Class 200 can output either a **voltage** or a **current** signal.

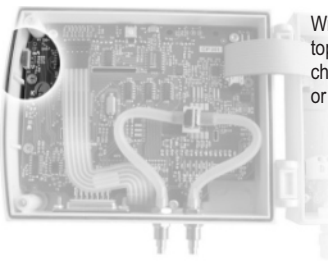

With the on-off switch located on the left top of the transmitter (when open), you can choose analogue output 0-10V (voltage) or 4-20 mA (current)

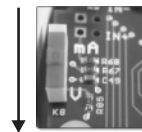

Down  
0-10 V

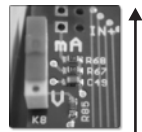

Up  
4-20 mA

## 1.c - Protection tip of the sensor



*It's extremely unwise to remove the protection tip of our hygrometry probes as the sensitive element is very fragile even to light contacts. However, if you have to remove the protection tip, take all possible precautions and avoid any contact with the sensitive element. To remove the protection tip, unscrew it or unclip it.*

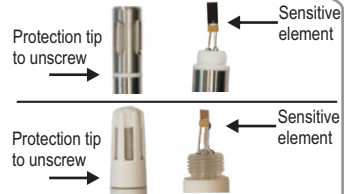



## 2. Code activation and access to functions



**This step is COMPULSORY for each configuration.**

To access the transmitter functions, **and for safety**, you have to first enter a safety code.

- Please check that the transmitter is powered on.
- If the transmitter displays an error code, please see “Errors Code” section on page 29

### Step 1

Press **OK** to get this screen



### Step 2

Enter the CODE “0101” with the keypad and validate with **OK**

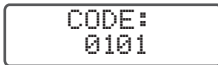

### Step 3

This screen appears

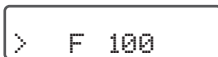

### Step 4

Configuration folder selection

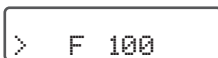

The first “0” blinks, which means that this column is activated and you can enter data from the keypad.



The code must be entered from left to right.

To **increment** a value or a level, press **+**

To **decrement** a value or a level, press **-**

To **validate a value (level) or to validate the code**, press **OK**

To return to the **previous status or to cancel**, press **Esc**



This screen confirms that the code was correctly entered, and that you can **configure the transmitter**.

If the code was wrongly entered, the transmitter initializes and returns to the starting display.

Shows the ongoing modification  
**Note** : here, only one line is modifiable

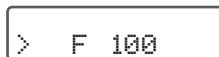

“F” as  
“Function”

#### Configuration folder number

The transmitter includes **6 folders** maximum :

- 100 • 400
- 200 • 500
- 300 • 600

Ex. In the folder 400, you can configure the alarms and relays. See page 10.



To select your configuration folder, press **+** to increment 100 or press **-** to decrement 100.

Once the folder is selected, press **OK** to validate.



**On the top left of each page** of this manual, you can find a reminder of the configuration folder where the function is available.

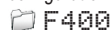

### 3.a - Backlight

With the backlight, the reading is easier with more contrast, if the ambient light is weak. You can activate or deactivate it.

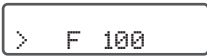
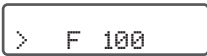
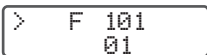
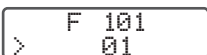
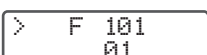
- Step 1**  Go into the configuration mode (see page 2). The folder number displayed corresponds to the last folder used.
- Step 2**  Select the folder "100" and validate with **OK**.
- Step 3**  Select the sub-folder "101" and validate with **OK**. The cursor > goes to the line of available choices.
- Step 4**  With **+** and **-** keys, select **00** to **deactivate** the backlight or **01** to **activate**. Validate with **OK**.
- Step 5**  The cursor > returns to sub-folders line.
- press twice **Esc** to return to reading mode.
  - press once **Esc** to select another folder.
  - with **+** and **-** keys, you can choose another sub-folder from the folder 100



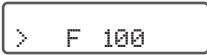
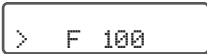
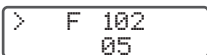
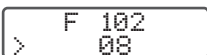
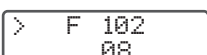







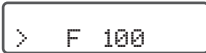
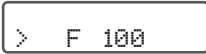

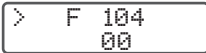
### 3.b - Display contrast control

- Step 1**  Go into configuration mode (see page 2). The folder number which appears corresponds to the last configuration folder used.
- Step 2**  Select the folder "100" and validate with **OK**.
- Step 3**  Select the sub-folder "102" and validate with **OK**. The cursor > goes to the line of available choices.
- Step 4**  With **+** and **-** keys, set the contrast required (from **0** to **10**). Validate with **OK**.
- Step 5**  The cursor > returns to sub-folders line.
- press twice **Esc** to return to reading mode.
  - press once **Esc** to return to another folder selection.
  - with **+** and **-** keys, you can choose another sub-folder from folder 100.

### 3.c - Keypad locking

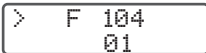

For safety, you can lock the keypad access. Like on a mobile phone, the keys will be disabled after having been locked.

- Step 1**  Go into configuration mode (see page 2). The folder number which appears corresponds to the last folder used.
- Step 2**  Select the folder "100" and validate with .
- Step 3**  Select the sub-folder "104" and validate .  
The cursor > goes to the different choices available.
- Step 4**  With  and  keys, select 01 to **lock** the keypad access or 00 if you **do not want to lock the keypad**. Validate with .
- Step 5**  The cursor > returns to sub-folders line.
  - press twice  to return to reading mode.
  - press once  to return to another folder selection.
  - with  and  keys to choose another sub-folder from the folder 100



**To unlock keypad access, press and hold the  key for 10 seconds.**

After 10 seconds, an **audible signal** confirms that the keypad is unlocked.



**F200**

## 4. Configuring channels and units of measurement

Class200 transmitters have 2 measuring channels. You can activate 1, or 2 channels and select each unit of measurement.

**Step 1**

> F 100

Go into configuration mode (see page 2). The folder number displayed corresponds to the last configuration folder used.

**Step 2**

> F 200

Select the folder "200" and validate with  $\odot$ .

**Step 3**

> F 200  
01

**Channel n°1**  
Select sub-folder "200"  
and validate with  $\odot$ . The cursor > goes to choices line

**Channel n°2**  
Select sub-folder "201"

**Step 4**

> F 200  
04

With  $\oplus$  and  $\ominus$  keys, select the unit of measurement (see chart below).  
Validate with  $\odot$ .

	CP201 et 202	CP203 et 204	TH200	CTV210
00	inactive channel	Inactive channel	Inactive channel	Inactive channel
01	Pa	mbar	°C	m/s
02	mmH <sub>2</sub> O	inWg	°F	fpm
03	inWg	KPa	%RH	°C
04	mbar	PSI	g/Kg (absolute humid. p)	°F
05	mmHg	mmHg	°C (dew temp. Td)	m <sup>3</sup> /h
06	m/s	m/s	°F (dew temp. Td)	L/s
07	fpm	fpm	°C (Humid temp. Tw)	cfm
08	m <sup>3</sup> /h	m <sup>3</sup> /h	°F (Humid temp. Tw)	m <sup>3</sup> /s
09	L/s	L/s	KJ/Kg (Enthalpy i)	
10	cfm	cfm		
11	m <sup>3</sup> /s	m <sup>3</sup> /s		



For a CP 200 transmitter (201, 202, 203 and 204), the **SQR option** is required in order to activate the units of air velocity and airflow (from 06 to 11)

**Step 5**

> F 200  
04

The cursor > returns to sub-folders line.

- press twice  $\text{Esc}$  to return to reading mode.
- press once  $\text{Esc}$  to return to another folder selection.
- with  $\oplus$  and  $\ominus$  keys to choose another sub-folder from the folder 200.

## 5.a - Output diagnostics

With this function, you can check with a multimeter (or a regulator/display, or a PLC/BMS) if the transmitter outputs are working properly. The transmitter generates a voltage of 0 V, 5 V and 10 V or a current of 4 mA, 12 mA and 20 mA.

### 5.a.1 - Multimeter connection configuration

Before carrying out the output diagnostics, all connections and configurations of the transmitter must be enabled, to avoid any damage on the transmitter and the multimeter!

**Step 1**  
**Selection of the channel to be checked**

First, **select a channel** for the output diagnostics.

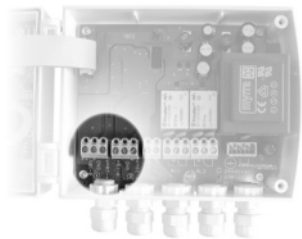

The channel numbers are indicated on the board located below the terminal block.

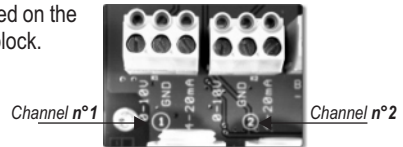

**Step 2**  
**Example of connection**

On the photo alongside, the multimeter is connected to the 0-10 V output and channel n°1.

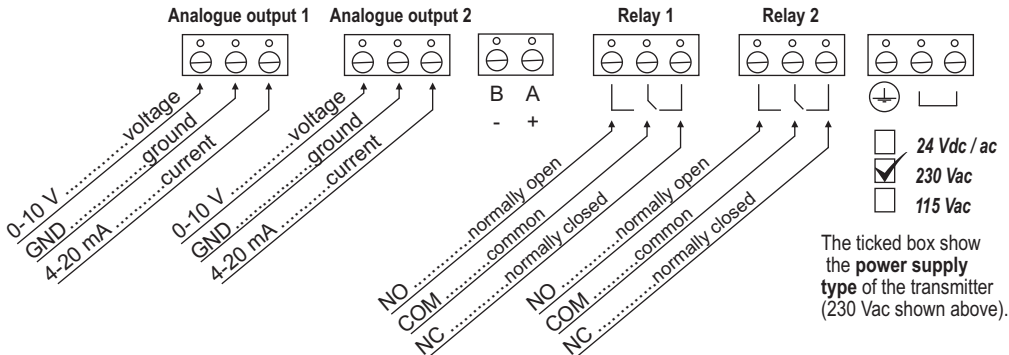
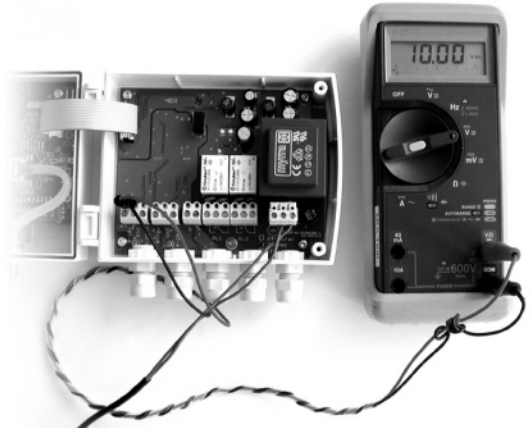

### 5.a.2 - Output diagnostics

Once the connection of the transmitter to the multimeter (or regulator or PLC/BMS is complete, (see page 6), you can carry out the analogue output diagnostics on several check points.

**Step 1** > F 100

Go into configuration mode (see page 2). The folder number displayed corresponds to the last configuration folder used.

**Step 2** > F 300

Select the folder "300" and validate with **OK**.

**Step 3** > F 300  
00

**Channel n° 1 output**  
Select sub-folder "300"

**Channel n° 2 output**  
Select sub-folder "303"

and validate with **OK**.

The cursor > goes to available choices..

**Step 4** > F 300  
04

With **+** and **-** keys, select the signal that the transmitter must output (see chart below). Note : no need to validate with **OK**.



	<i>Diagnostic output</i>
00	0 V
01	5 V
02	10 V
03	4 mA
04	12 mA
05	20 mA



**If the deviations are too large (>0,05V or >0,05mA) between the signal issued and the value displayed on the multimeter, we recommend that you return the transmitter to our factory.**

**Step 5** > F 300  
04

The cursor > returns to sub-folders line.

- press twice **ESC** to return to reading mode.
- press once **ESC** to return to another folder selection.
- with **+** and **-** keys to choose another sub-folder from the folder 300.



## 5.b - Analogue output settings

With this function, you can modify the measuring range of the transmitter, and you can equate the new limits to the analogue output (0-10V or 4-20mA).

You can enter the measuring range required on your own !



**You must enter the values according to the units of measurement selected, not according to the measuring range of the transmitter.**

*Ex. on a CP 201 pressure transmitter (0 to  $\pm 1000$  Pa) with a reading in mmH<sub>2</sub>O, the minimum and maximum ranges must be configured on measuring range of 0 to  $\pm 102$  mmH<sub>2</sub>O. See **conversion chart on following page**.*

**Step 1**

> F 100

Go into configuration mode (see page 2). The folder number displayed corresponds to the last configuration folder used.

**Step 2**

> F 300

Select the folder "300" and validate with **OK**.

**Step 3**

> F 301  
-100

**Minimum** of Channel n°1  
output

**Minimum** of Channel n°2  
output

Select sub-folder "301"

Select sub-folder "304"

and validate with **OK**. The cursor > returns to the input line.

**Step 4**

> F 301  
> -00100

With **+** and **-** keys, select the value sign: negative or positive, validate with **OK**. Then, enter the minimum limit value and validate with **OK**.

**Step 5**

> F 302  
+500

**Maximum** of Channel n°1  
output

**Maximum** of Channel n°2  
output

Select sub-folder "302"

Select sub-folder "305"

and validate with **OK**. The cursor > goes to the input line.

**Step 6**

> F 302  
> +00500

With **+** and **-** keys, select the value sign: negative or positive, validate with **OK**.

Then, enter the maximum limit value and validate with **OK**.



**We recommend that the interval between the minimum and maximum is > 5% of the measuring range.**

**Step 7**

> F 302  
+500

The cursor > goes to sub-folders line.

- press twice **Esc** to return to reading mode.
- press once **Esc** to return to another folder selection.
- with **+** and **-** keys you can choose another sub-folder from the folder 300.



After an analogue output setting, if the unit of measurement is modified (see page 5), you have to reconfigure the outputs according to the new unit of measurement.

**5.b.1 - Units of measurement conversion chart**

## Pressure

	<i>Pa</i>	<i>mmH2O</i>	<i>inWg</i>	<i>mbar</i>	<i>mmHg</i>	<i>KPa</i>	<i>PSI</i>
<b>CP201</b>	0 to ±1000	0 to ±102,0	0 to ± 4,015	0 to ±10,00	0 to ±7,50	-	-
<b>CP202</b>	0 to ±10000	0 to ±1020,0	0 to ±40,15	0 to ±100,00	0 to ±75,00	-	-
<b>CP 203</b>	-	-	0 to ±200,0	0 to ±500	0 to ±375	0 to ±50,0	0 to ±7,50
<b>CP 204</b>	-	-	0 to ±800,0	0 to ±2000	0 to ±1500	0 to ±200,0	0 to ±30,00

## Temperature

	<b>°C</b>	<b>°F</b>
<b>TH200 - St.steel probe</b>	-40,0 to +180,0	-40,0 to +356,0
<b>TH 200 - PC probe</b>	-20,0 to +80,0	-4,0 to +176,0
<b>CTV 210</b>	0,0 to +50,0	+32,0 to +122,0

## Air velocity (CTV 210)

	<i>m/s</i>	<i>fpm</i>
<b>CTV210</b>	0,0 to 30,0	0 to 5905

## 6.a - Activation / Deactivation of BEEP alarm

The beep alarm (audible alarm) is activated when a set point is reached.  
For more details on the setpoint settings, see page 16.

- |               |               |   |
|---------------|---------------|---|
| <b>Step 1</b> | > F 100       | Enter in mode configuration (cf. page 2). Le numéro de dossier affiché correspond au dernier dossier de configuration utilisé.  |
| <b>Step 2</b> | > F 400       | Select the folder "400" and validate with <b>OK</b> .   |
| <b>Step 3</b> | > F 400<br>01 | Select sub-folder "400" and validate with <b>OK</b> .<br>The cursor > goes to available choices.  |
| <b>Step 4</b> | > F 400<br>01 | With <b>+</b> and <b>-</b> keys, select 01 to <b>activate</b> the BEEP alarm or 00 to <b>deactivate</b> . Validate with <b>OK</b> .   |
| <b>Step 5</b> | > F 400<br>01 | The cursor > goes to sub-folders line.<br><ul style="list-style-type: none"> <li>• press twice on <b>Esc</b> to return to reading mode.</li> <li>• press once on <b>Esc</b> to return to another folder selection.</li> <li>• with <b>+</b> and <b>-</b> keys you can choose another sub-folder from the folder 400.</li> </ul> |

## 6.b - Relay security

The relay outputs are by default, in **negative security**: the relay is **energized** when a set point is reached.  
With the keypad, you can swap the relays in **positive security**: then, the relay is **de-energized** when a set point is reached or during a power outage.

- |               |               |   |
|---------------|---------------|---|
| <b>Step 1</b> | > F 100       | Enter in configuration mode (see page 2). The folder number displayed corresponds to the last configuration folder used.  |
| <b>Step 2</b> | > F 400       | Select folder "400" and validate with <b>OK</b> .   |
| <b>Step 3</b> | > F 401<br>01 | Select sub-folder "401" and validate with <b>OK</b> .<br>The cursor > goes to available choices.<br>Le curseur > descend sur la ligne des choix possibles.  |
| <b>Step 4</b> | > F 401<br>01 | With <b>+</b> and <b>-</b> keys, select 01 for a <b>positive security</b> or 00 for a <b>negative security</b> . Validate with <b>OK</b> .  |
| <b>Step 5</b> | > F 401<br>01 | The cursor > returns to sub-folders line.<br><ul style="list-style-type: none"> <li>• press twice on <b>Esc</b> to return to reading mode.</li> <li>• press once on <b>Esc</b> to return to another folder selection.</li> <li>• with <b>+</b> and <b>-</b> keys, you can choose another sub-folder from the folder 400.</li> </ul> |

### 6.c - Alarm / relay functions and LED colour codes

#### 6.c.1 - Visual / audible alarms

Class 200 transmitters have 2 visual / audible alarms located in front of the transmitter, allowing to know the condition of the setpoints.

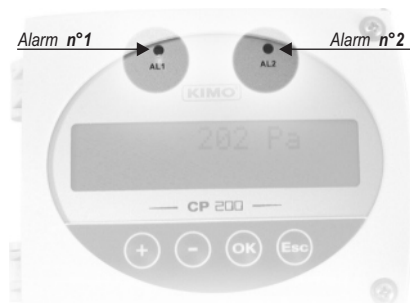

#### Alarm LED colour codes

- Green** The alarm function is activated and the set point is not reached
- Red** The alarm function is activated and the setpoint is reached
- None** The alarm function **is not activated**



The red LED appears when the setpoint is reached, taking into account the time-delay and the action type (falling or rising).  
See page 13 for more details.

#### Audible alarm

**Once the alarm is activated**, an alarm sounds whilst the setpoint is reached.



The BEEP alarm function must be activated to use the audible alarm. See page 10.

#### 6.c.2 - Les relais

Class 200 transmitters have 2 relays visible on the transmitter board. These 2 relays each have one LED to allow **real-time checking**.

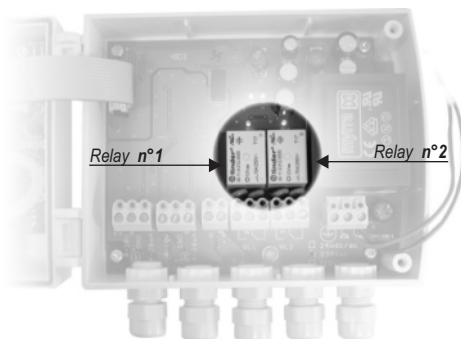

Relay n°1  
LED



Relay n°2  
LED

#### Relay LED colour codes

- Red** The relay is **energized**
- None** The relay is **not energized** or **has not been configured**



The relay is energized when the setpoint is reached, taking into account the time-delay, the action type and also the alarms security mode.  
Set points, time-delay and action type setting: see page 16  
Alarm security settings : see page 10

## 6.d - Selection of the channel for visual and relays alarms

Class 200 transmitters have 4 alarms: 2 visual (LED) and audible alarms and 2 relay alarms. The transmitter can be configured with 4 different alarms setups.



**Before any alarm setup, check that the corresponding channel(s) is activated.**

**Step 1**

> F 100

Go into configuration mode (see page 2). The folder number displayed corresponds to the last configuration folder used.

**Step 2**

> F 400

Select the folder "400" and validate with **OK**.

**Step 3**

> F 402  
01

Select sub-folder

"402"  
Alarm 1  
(Led 1)

"407"  
Alarm 2  
(Led 2)

"412"  
Relay 1

"417"  
Relay 2

and validate with **OK**.

**Step 4**

> F 402  
01

With **+** and **-** keys, select the channel number for which you want to configure an alarm. Validate with **OK**.

**Step 5**

> F 402  
01

The cursor > returns to sub-folders line.

- press twice **Esc** to return to reading mode.
- press once **Esc** to return to another folder selection.
- with **+** and **-** keys, you can choose another sub-folder from the folder 400 (i.e. for example to configure another alarm / relay)



## 6.e - Alarm mode details

### 6.e.1 - Definitions

#### Seuil

The setpoint is a limit which, on being reached and/or exceeded, activates an alarm or energizes a relay (in negative security, see page 10 for more details).

#### Time-delay

Once the setpoint is reached and/or exceeded, the time-delay postpones the alarm activation (or relay excitation) for a short period (in seconds). Once this period is elapsed, and if the setpoint is still exceeded, then the alarm is activated or the relay is energized (in negative security).

#### Action type

For alarm activation or relay excitation, you can choose the action type: rising or falling action.

- **Rising action:** the alarm is activated once the measurement **goes over** the setpoint
- **Falling action:** the alarm is activated once the measurement **goes below** the setpoint

### 6.e.2 - Available configurations

Configuration N°1 : 2 setpoints and time-delay activated (Control Mode)

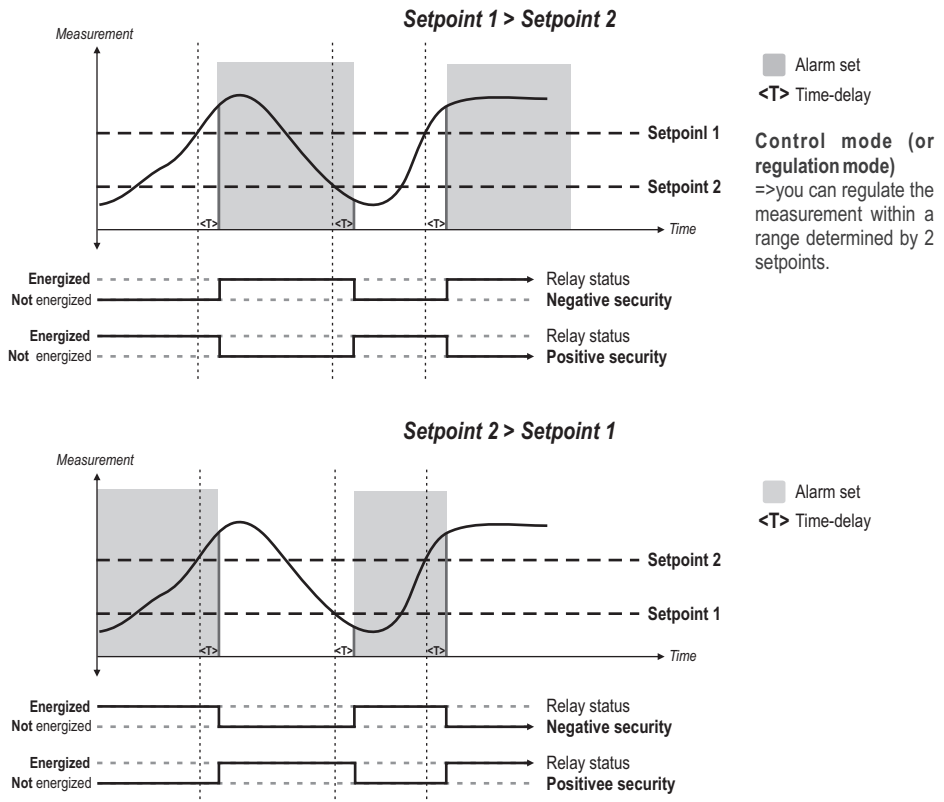



## Configuration N°2 : 1 setpoint, time-delay and rising action activated

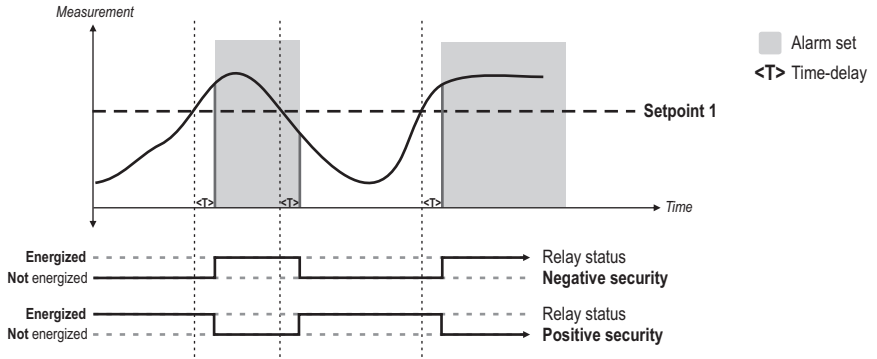

## Configuration N°3 : 1 setpoint, time-delay and falling action activated

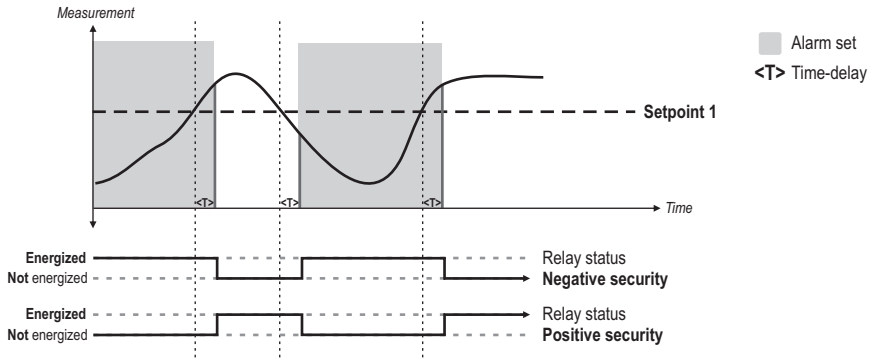

### 6.f - Alarm mode selection

**Step 1** > F 100

Go into configuration mode (see page 2). The folder number displayed corresponds to the last configuration folder used.

**Step 2** > F 400

Select the folder "400" and validate with  $\odot$ .

**Step 3** > F 403  
02

Select sub-folder

Mode	Alarm 1	Alarm 2	Relay 1	Relay 2
	"403"	"408"	"413"	"418"

and validate with  $\odot$ .

**Step 4** > F 403  
02

With  $\oplus$  and  $\ominus$  keys, select the code relative to the alarm mode (see chart below). Validate with  $\odot$ .

Code	Alarm mode	Drawing
00	No alarm	
01	2 setpoints with time-delay (control mode)	N° 1 page 13
02	1 setpoint with time-delay and rising action	N° 2 page 14
03	1 setpoint with time-delay and falling action	N° 3 page 14

**Step 5** > F 403  
02

The cursor > returns to sub-folders line.

- press twice  $\odot$  to return to reading mode.
- press once  $\odot$  to return to another folder selection.
- with  $\oplus$  and  $\ominus$  keys, you can choose another sub-folder from the folder 400.

### 6.g - Setpoints and time-delay setting

#### 6.g.1 - Setpoints

**Step 1** > F 100

Go into configuration mode (see page 2). The folder number displayed corresponds to the last configuration folder used.

**Step 2** > F 400

Select the folder "400" and validate with **OK**.

**Step 3** > F 404  
02

Select sub-folder

	Alarm 1	Alarm 2	Relay 1	Relay 2
<b>Setpoint 1</b>	"404"	"409"	"414"	"419"

To configure the **setpoint 2** (alarm in **control mode**, see p13), select sub-folder

<b>Setpoint 2</b>	"405"	"410"	"415"	"420"
-------------------	-------	-------	-------	-------

and validate with **OK**.

**Step 4** > F 404  
-00100

With **+** and **-** keys, select the value sign: negative or positive. Validate with **OK**.

Then, enter the setpoint value and validate with **OK**.

**!** You must enter values according to the units of measurement selected, not according to the measuring range of the transmitter.

*Ex. on a CP 201 pressure transmitter (0 to ±1000 Pa) with a reading in mmH<sub>2</sub>O, the minimum and maximum ranges must be configured on measuring range of 0 to ±102 mmH<sub>2</sub>O. See conversion chart on page 9.*

**Step 5** > F 404  
-100

The cursor > returns to sub-folders line.

- press twice **Esc** to return to reading mode.
- press once **Esc** to return to another folder selection.
- with **+** and **-** keys, you can choose another sub-folder from the folder 400.

**NOTE** If after having set up a setpoint, the unit of measurement is modified (see page 5), then you have to reconfigure the setpoints according to this new unit of measurement.



## 6.g.2 - Time-delay

Step  
1

&gt; F 100

Go into configuration mode (see page 2). The folder number displayed corresponds to the last configuration folder used.

Step  
2

&gt; F 400

Select the folder "400" and validate with **OK**.

Step  
3> F 406  
02

Select sub-folder

	Alarm 1	Alarm 2	Relay 1	Relay 2
Tempo	"406"	"411"	"416"	"421"

and validate with **OK**.

Step  
4> F 406  
15

With **+** and **-** keys, set the required time-delay: from 00 to 60 seconds. If you do not need the time-delay, enter 00. Validate with **OK**.

Step  
5> F 406  
15

The cursor > returns to sub-folders line.

- press twice **Esc** to return to reading mode.
- press once **Esc** to return to another folder selection.
- with **+** and **-** keys, you can choose another sub-folder from the folder 400.



## 7.a - Pressure measurement integration

The pressure measurement element is very sensitive and reacts to pressure changes. When making measurements in unstable air movement conditions, the pressure measurement may fluctuate. The integration coefficient (from 0 to 9) makes an average of the measurements ; this helps to avoid any excessive variations and guarantees a stable measurement.

*This value is applicable when the variation is less than +/- (Coef. x 10 Pa)*

**Example : CP201 (0-1000 Pa) - First measurement: 120 Pa - New measurement : 125 Pa**

The pressure source is stable, the user applied a low integration. Integration : 1, maximum variation allowed +/-10 Pa. Since the variation is less than 10 Pa, we apply the integration calculation formula. Next measurement displayed  $((9 * 125) + (1 * 120)) / 10 = 124.5$  soit 124 Pa. If the new value had been 131 Pa, the next value displayed would have been 100% of the new value, i.e 131 Pa.



Function only available on pressure transmitters:

**CP 201, CP 202, CP 203 and CP 204**

**Step 1**

> F 100

Go into configuration mode (see page 2). The folder number displayed corresponds to the last configuration folder used.

**Step 2**

> F 500

Select the folder "500" and validate with **OK**.

**Step 3**

> F 500  
09

Select the sub-folder "500" and validate with **OK**.  
The cursor > returns to available choices.

**Step 4**

> F 500  
09

With **+** and **-** keys, you can set the integration value: from 00 to 09.

Validate with **OK**.

**Coefficient 0** : no integration, large variation of the measurement displayed.

**Coefficient 9** : maximum integration, more stable measurement display.

**Step 5**

> F 500

The cursor > returns to sub-folder selection

- press once **Esc** to return to reading mode
- or choose another folder to access other functions.

## 7.b - Autozero

Thanks to the temperature compensation of the gain (from 0 to 50°C) and to the manual auto-zero, Class 200 transmitters guarantee an excellent long-term stability, along with great measurement accuracy (in low and high ranges). The autozero compensates for any long-term drifts of the sensitive element, with the manual adjusting of the zero.

To autozero, unplug the 2 pressure connections tubes, and press on the AUTOZERO key (see "connection"). If the pressure transmitter has a display screen, it's possible to autozero by pressing the **Esc** button for 5 seconds.

### 8.a - Offset setting in humidity and temperature

In order to compensate for any longterm drift of the transmitter, you can add an offset to the value displayed by the TH 200 with the EHK 500 reference portable instrument or via the keypad.



 Function only available on humidity transmitters: TH 200





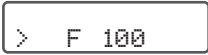
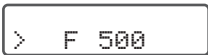
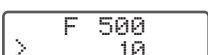
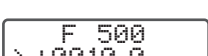

The EHK 500 is a reference portable instrument (optional) which enables you to adjust at one point the humidity and temperature reading, via the RS 232 connection cable. Thanks to this new time-saving system, no need to return the transmitter to our factory.

**Your transmitter is always available on site.** For more details, see technical datasheet and user manual of EHK 500.

#### 8.a.1 - Offset in hygrometry

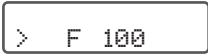
- Step 1**  Go into the configuration mode (see page 2). The folder number displayed corresponds to the last folder used.
- Step 2**  Select folder "500" and validate with **OK**.
- Step 3**  Select sub-folder "500" and validate with **OK**. The cursor > goes to the line of available choices.
- Step 4**  With keys **+** and **-**, enter the offset value: from -50.0 to +50.0. Validate with **OK**.
- Step 5**  The cursor > returns to sub-folders line.  
 • press once on **ESC** to return to reading mode.  
 • or choose another folder to access other functions.

#### 8.a.2 - Offset in temperature

- Step 1**  Go into the configuration mode (see page 2). The folder number displayed corresponds to the last folder used.
- Step 2**  Select folder "500" and validate with **OK**.
- Step 3**  Select sub-folder "501" for an offset in °C or "502" for an offset in °F and validate with **OK**. The cursor > goes to the line of available choices.
- Step 4**  With keys **+** and **-**, enter the offset value: from -50.0 to +50.0 (in °C) or from -90 to +90 (in °F). Validate with **OK**.
- Step 5**  The cursor > returns to folders line.  
 • press once on **ESC** to return to reading mode.  
 • or choose another folder to access other functions.



If you activate the offset in temperature in °C (function 501), the value entered is automatically converted into °F (function 502) and vice versa.



## 9.a - Temperature compensation

You can **modify the temperature compensation value**.

The air velocity and airflow measured with a differential probe (such as Pitot tube, Debimo blade, orifice plate...) depends on the working temperature. Then, it is required to enter the **working temperature** to get more accurate results.



Function available only on pressure transmitters: **CP 200**

Step  
**1**

```
> F 100
```

Go into configuration mode (see page 2). The folder number displayed corresponds to the last configuration folder used.

Step  
**2**

```
> F 600
```

Select the folder "**600**" and validate with **OK**.

Step  
**3**

```
> F 600
  20
```

Select the sub-folder "**600**" to enter a value in **°C** or "**601**" to enter a value in **°F**, validate with **OK**.  
The cursor > returns to available choices.

Step  
**4**

```
> F 600
  20
```

With **+** and **-** keys, enter the temperature compensation (Celsius degree shown alongside, sub-folder "600"). Validate with **OK**.

Step  
**5**

```
> F 600
  20
```

The cursor > returns to sub-folders line.

- press twice **Esc** to return to reading mode.
- press once **Esc** to return to another folder selection.
- with **+** and **-** keys, you can choose another sub-folder from the folder 600.

**NOTE**

If you make a temperature compensation in Celsius degree (sub-folder "600"), the transmitter will automatically make the conversion into Fahrenheit degree (sub-folder "601") and vice versa.



### 9.b - Air velocity coefficient selection (CP 200)

Since the air velocity is calculated from the pressure (on a CP 200) and from a differential probe, **you must enter the coefficient value of the differential probe**. For Pitot tubes and Debimo blades, the coefficient is already included in the transmitter.



Function only available on pressure transmitters: **CP 200**

**Step 1**

```
> F 100
```

Go into configuration mode (see page 2). The folder number displayed corresponds to the last configuration folder used.

**Step 2**

```
> F 600
```

Select the folder "600" and validate with **OK**.

**Step 3**

```
> F 603
  00
```

Select the sub-folder "603" and validate with **OK**.  
The cursor > goes to available choices.

**Step 4**

```
> F 603
  00
```

With **+** and **-** keys, select the differential probe type. Validate with **OK**.

Code	Differential probe	Coef.
00	Pitot tube L (ISO 3966)	1
01	DEBIMO blade	0.8165
02	Other differential probe	To be entered

**Step 5**

```
> F 603
  00
```

The cursor > returns to sub-folders line.

- press twice **Esc** to return to reading mode.
- press once **Esc** to return to another folder selection.
- with **+** and **-** keys, you can choose another sub-folder from the folder 600.



If you use "Other differential probe" please carefully follow the instructions below.

#### 9.b.1 - Manual coefficient input

**Step 1**

```
> F 600
```

Select the folder "600" and validate with **OK**.

**Step 2**

```
> F 604
  0.8165
```

Select the sub-folder "604" and validate with **OK**.  
The cursor > goes to available choices.

**Step 3**

```
> F 604
  0.8165
```

With **+** and **-** keys, **enter the coefficient relative to your differential probe**. This coefficient is given by the manufacturer (from 0.0001 to 9.9999).  
Validate with **OK**.

**Step 4**

```
> F 604
  0.8165
```

The cursor > returns to sub-folders line.

- press twice **Esc** to return to reading mode.
- press once **Esc** to return to another folder selection.
- with **+** and **-** keys, you can choose another sub-folder from the folder 600.

### 9.c- Air velocity coefficient input

With this correction coefficient, you can adjust the transmitter according to the air velocity in your installation.



Function only available on transmitters: **CP 200 and CTV 210**

#### 9.c.1 - How to calculate it ?

If the air velocity in your duct is equal to **17 m/s**, and if the transmitter indicates **16.6 m/s**, then the coefficient to apply is  $17/16,6$ , ie **1.024**

#### 9.c.2 - Coefficient input

- |   |                  |   |
|---|------------------|---|
| <div style="border: 1px solid black; padding: 2px; display: inline-block;"><b>Step</b><br/><b>1</b></div> | > F 100          | Go into configuration mode (see page 2). The folder number displayed corresponds to the last configuration folder used.   |
| <div style="border: 1px solid black; padding: 2px; display: inline-block;"><b>Step</b><br/><b>2</b></div> | > F 600          | Select the folder "600" and validate with <b>OK</b> .   |
| <div style="border: 1px solid black; padding: 2px; display: inline-block;"><b>Step</b><br/><b>3</b></div> | > F 605<br>00    | Select the sub-folder "605" and validate with <b>OK</b> .<br>The cursor > goes to available choices.  |
| <div style="border: 1px solid black; padding: 2px; display: inline-block;"><b>Step</b><br/><b>4</b></div> | F 605<br>> 1.024 | With <b>+</b> and <b>-</b> keys, <b>enter the coefficient value</b> calculated (from 0.200 to 2.000). Validate with <b>OK</b> .   |
| <div style="border: 1px solid black; padding: 2px; display: inline-block;"><b>Step</b><br/><b>5</b></div> | > F 605<br>1.024 | The cursor > returns to the sub-folders line. <ul style="list-style-type: none"> <li>• press twice <b>Esc</b> to return to reading mode.</li> <li>• press once <b>Esc</b> to return to another folder selection.</li> <li>• with <b>+</b> et <b>-</b> keys, you can choose another sub-folder from the folder 600.</li> </ul> |

## 10.a - Selection of duct section type or airflow coefficient

### 10.a.1 - Working from the section type



Function only available on pressure transmitters: **CP 200** and **CTV 210**

**Step 1**

> F 100

Go into configuration mode (see page 2). The folder number displayed corresponds to the last configuration folder used.

**Step 2**

> F 600

Select the folder "600" and validate with **OK**.

**Step 3**

> F 606  
00

Select the sub-folder "606" and validate with **OK**.  
The cursor > goes to available choices.

**Step 4**

F 606  
> 00

With **+** and **-** keys, select the section type (00 or 01).  
Validate with **OK**.

Code	Section type
00	Rectangular
01	Circular
02	Airflow coefficient (to be entered, see p 24)

**Step 5**

> F 606  
00

The cursor > returns to sub-folders line.

- press twice **Esc** to return to reading mode.
- press once **Esc** to return to another folder selection.
- with **+** and **-** keys to choose another sub-folder from the folder 600.

### Section sizes input

**Step 1**

> F 100

Go into configuration mode (see page 2). The folder number displayed corresponds to the last configuration folder used.

**Step 2**

> F 600

Select the folder "600" and validate with **OK**.

**Step 3**

> F 607  
1500

Select sub-folder

	Rectangular section		Circular section
	Length	Width	diameter
mm	"607"	"608"	"609"
inch	"610"	"611"	"612"

and validate with **OK**.



Step  
4

> F 607  
1500

With  $\oplus$  and  $\ominus$  keys, enter the value (from 0 to 3000mm or 0 to 118.11 inch).  
Validate with  $\text{OK}$ .

Step  
5

> F 607  
1500

The cursor > returns to sub-folders line.  
• press twice  $\text{Esc}$  to return to reading mode.  
• press once  $\text{Esc}$  to return to another folder selection.  
• with  $\oplus$  and  $\ominus$  keys, you can choose another sub-folder from the folder 600.



If you enter a length, width or diameter in mm, the transmitter will automatically calculate the conversion in Inch (in sub-folder "601") and vice versa

### 10.a.2 - Working from a airflow coefficient

With this coefficient, you can calculate the airflow from the pressure. This coefficient is given by the manufacturer of the devices supplied with pressure connections (+ and -). From the square root of the pressure measured (Delta P), and from this coefficient, you get the airflow.

$$\text{Airflow} = C_p \times \sqrt{\Delta \text{Pressure}}$$



Function only available for the pressure transmitter: **CP 200 + SQR option**. In this calculation mode, you have **no access to reading of air velocity**. If you activate this calculation mode and also a channel in air velocity, the transmitter will display an error code "4".



**Go back to procedure page 23 / step 3:**

With  $\oplus$  and  $\ominus$  keys, select o2 and validate with  $\text{OK}$ .

Step  
1

> F 100

Go into configuration mode (see page 2). The folder number displayed corresponds to the last configuration folder used.

Step  
2

> F 600

Select the folder "600" and validate with  $\text{OK}$ .

Step  
3

> F 613  
40.25

Select the sub-folder "613" and validate with  $\text{OK}$ .  
The cursor > goes to available choices.

Step  
4

> F 613  
40.25

With  $\oplus$  and  $\ominus$  keys, enter the airflow coefficient value (from 0.1 to 9999.9).  
Validate with  $\text{OK}$ .

Step  
5

> F 614  
01

The cursor > returns to sub-folders line.  
Select the sub-folder "614" to select the **unit of measurement in pressure** for the airflow calculation and validate with  $\text{OK}$ .  
The cursor > returns to available choices.



Step  
**6**

F 614  
> 01

With  $\oplus$  and  $\ominus$  keys, select the unit of measurement (see chart below). Validate with  $\text{OK}$ .

	<i>Cp201 and 202</i>	<i>CP203 and 204</i>
01	Pa	mbar
02	mmH <sub>2</sub> O	inWg
03	inWg	KPa
04	mbar	PSI
05	mmHg	mmHg

Step  
**7**

> F 614  
01

The cursor > returns to sub-folders line.

- press twice  $\text{Esc}$  to return to reading mode.
- press once  $\text{Esc}$  to return to another folder selection.
- with  $\oplus$  and  $\ominus$  keys to choose another sub-folder from the folder 600.



## 11.a- Activation / deactivation of the RS 232

Class 200 transmitters have a RS 232 output.

With the RS 232, you can send measurements (ASCII format) to another transmitter from **Class 300**.

**Step 1**  
> F 100

Go into configuration mode (see page 2). The folder number displayed corresponds to the last configuration folder used.

**Step 2**  
> F 100

Select the folder "100" and validate with **OK**.

**Step 3**  
> F 103  
01

Select the sub-folder "103" and validate with **OK**.

**Step 4**  
F 103  
> 01

With **+** and **-** keys, select 00 to **deactivate** the RS 232 output or 01 to **activate**. Validate with **OK**.

**Step 5**  
> F 103  
01

The cursor > returns to sub-folders line.

- press twice **Esc** to return to reading mode.
- press once **Esc** to return to another folder selection.
- with **+** and **-** keys, you can choose another sub-folder from the folder 100.

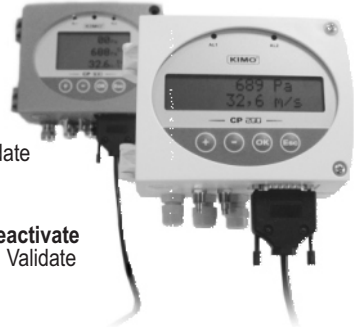

## 11.b- Serial number display

**Step 1**  
> F 100

Go into configuration mode (see page 2). The folder number displayed corresponds to the last configuration folder used.

**Step 2**  
> F 100

Select the folder "100" and validate with **OK**.

**Step 3**  
> F 105  
04.03.2004

select sub-folder "105"

**Step 4**  
> F 105  
04.03.2004

The serial number of the transmitter is displayed. The cursor > returns to sub-folders line.

- press twice **Esc** to return to reading mode.
- press once **Esc** to return to another folder selection.
- with **+** and **-** keys to choose another sub-folder from the folder 100.



## 11.c- Purge mode

The purge mode enables to freeze the measurement when being displayed, enables to lock the analogue outputs, and to activate the relay 1, in order to actuate a de-dust system of an air movement conditions system and to activate the relay 2 in order to isolate the transmitter.

Here is the detailed process of purge mode :

- 1 - Measurement is frozen.
- 2 - Wait for one second.
- 3 - Activation of relay 2 (isolation of the transmitter)
- 4 - Wait for time-delay.
- 5 - Activation of relay 1 (sending compressed air into the network to clean the installation)
- 6 - Purge duration
- 7 - Deactivation of relay 1 (stop sending compressed air).
- 8 - Wait for time-delay.
- 9 - Deactivation of relay 2
- 10 - Wait for one second.
- 11 - Recovery of measurement

This function is only available on **CP 200** pressure transmitters.

**Relay 1:** Command of purge electro-valve

**Relay 2:** Command of isolation electro-valve

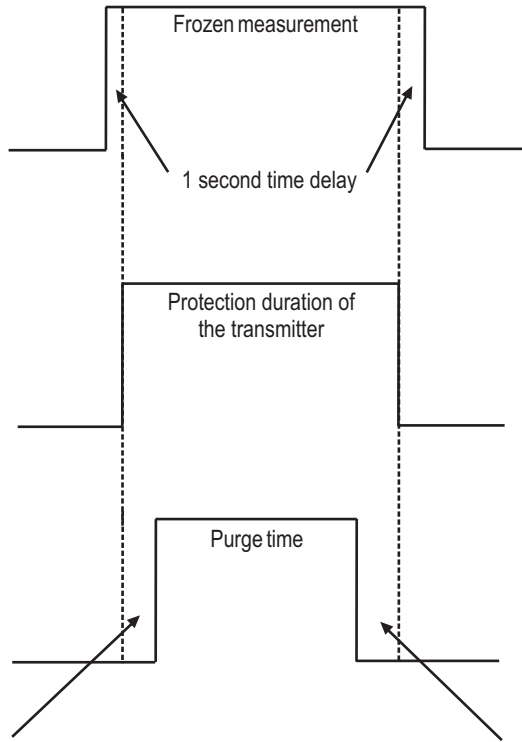

Time-delay of advance of triggering of the relay 2 corresponding : **Temporisation**



Time-delay of triggering of the relay 2 corresponding : **Temporisation**

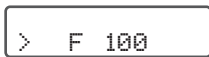
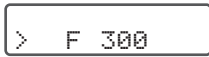
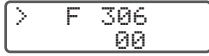
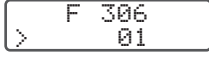
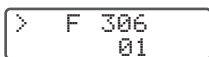

### 11.c.1-Activation / deactivation of Purge Mode

- Step 1**  Go into configuration mode (see page 5). The folder number displayed corresponds to the last configuration folder used.
- Step 2**  Select the folder "300" and validate with **OK**.
- Step 3**  Select the sub-folder "306" and validate with **OK**.
- Step 4**  With **+** and **-** keys, activate (01) or deactivate (00) the purge mode. Validate with **OK**.
- Step 5**  The cursor > returns to sub-folders line.
  - press twice **ESC** to return to reading mode.
  - press once **ESC** to return to another folder selection.
  - with **+** and **-** keys, choose another sub-folder from the folder 300

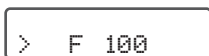
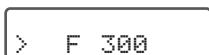
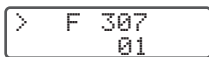

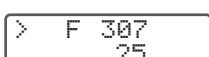
### 11.c.2-Working duration of purge mode

- Step 1**  Go into configuration mode (see page 5). The folder number displayed corresponds to the last configuration folder displayed.
- Step 2**  Select the folder "300" and validate with **OK**.
- Step 3**  Select the sub-folder "307" and validate with **OK**.
- Step 4**  With **+** and **-** keys, enter the value in seconds of the required working duration of each purge (from 01 to 60). Validate with **OK**.
- Step 5**  The cursor > returns to sub-folders line.
  - press twice **ESC** to return to reading mode.
  - press once **ESC** to return to another folder selection.
  - press **+** and **-** to choose another sub-folder from the folder 300



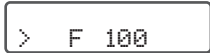

### 11.c.3 -Frequency

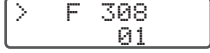
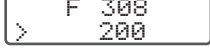
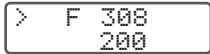
- Step 1**  Go into configuration mode (see page 5). The folder number displayed corresponds to the last configuration folder used.
- Step 2**  Select the folder "300" and validate with **OK**.
- Step 3**  Select the sub-folder "308" and validate with **OK**.
- Step 4**  With keys **+** and **-**, enter the value in minutes of the frequency of each purge (from 01 to 9999). Validate with **OK**.
- Step 5**  The cursor **>** returns to sub-folders line.
  - press twice **ESC** to return to reading mode.
  - press once **ESC** to return to another folder selection.
  - with **+** and **-**, choose another sub-folder from the folder 300.

### 11.c.4 - Time-delay

*Time-delay corresponds to the advanced and retardation lead time of triggering of the relay 2 relative to the relay 1.*

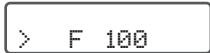
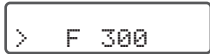
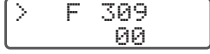
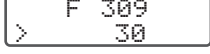
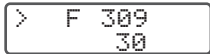
- Step 1**  Go into configuration mode (see page 5). The folder number displayed corresponds to the last configuration folder used.
- Step 2**  Select the folder "300" and validate with **OK**.
- Step 3**  Select the sub-folder "309" and validate with **OK**.
- Step 4**  With **+** and **-** keys, enter the value in seconds of the time-delay required (from 00 to 60). Validate with **OK**.
- Step 5**  The cursor **>** returns to the sub-folders line.
  - press twice **ESC** to return to reading mode.
  - press once **ESC** to return to another folder selection.
  - with **+** and **-** keys, choose another sub-folder from the folder 300.



## 12. Error codes

Code	Problem	Solution
01	Configuration error (alarm(s) set on a non displayed/activated channel)	<ul style="list-style-type: none"><li>• Check status of the 4 alarms and 2 channels.Ex. : the error appears if an alarm is configured on a channel (1 or 2) which is not active. Then, you must activate the channel on which you want to configure an alarm.</li></ul> <p><b>Activation of a channel</b> :see page 5</p> <p><b>Alarm and relay configurations</b>: see page 10</p>
02	No channel activated	<ul style="list-style-type: none"><li>• Activate one channel (at least).</li></ul> <p><b>Activation of a channel</b>: see page 5</p>
03	Only on Th200 transmitter. Humidity probe not connected.	<ul style="list-style-type: none"><li>• Connect the probe.</li></ul>
04	Only on the CP 200 transmitter. A channel is configured in air velocity (see page 5) and the airflow calculation function (page 23) is set to 02 (airflow coefficient). This combination is <b>impossible</b> .	<ul style="list-style-type: none"><li>• Select a unit in airflow for the channel 1 or 2 (see channels configuration, page 5)</li><li>• Instead of airflow coefficient, select a circular or rectangular section in function 606 (see page 23)</li></ul>



## F 100

Code	Description	Available settings
101	Backlight	0 or 1
102	Display contrast control	from 0 to 10
103	Sending data via Rs232	0 or 1
104	Keypad locking	0 or 1
105	Serial number display	

## F 200

Code	Description	Available settings			
		CP201 and 202	CP203 and 204	TH200	CTV210
00	Unit of channel 1	Inactive channel	Inactive channel	Inactive channel	Inactive channel
01	Unit of channel 2	Pa	mbar	°C	m/s
02		mmH <sub>2</sub> O	inWg	°F	fpm
03		inWg	KPa	%RH	°C
04		mbar	PSI	g/Kg (absolute humid. p)	°F
05		mmHg	mmHg	°C (dew temp. Td)	m <sup>3</sup> /h
06		m/s	m/s	°F (dew temp. Td)	L/s
07		fpm	fpm	°C (humid temp. Tw)	cfm
08		m <sup>3</sup> /h	m <sup>3</sup> /h	°F (humid temp. Tw)	m <sup>3</sup> /s
09		L/s	L/s	KJ/Kg (Enthalpy i)	
10		cfm	cfm		
11		m <sup>3</sup> /s	m <sup>3</sup> /s		

## F 300

	Code	Description	Available settings
channel 1	300	Analogue output setting on channel 1	0=>0V, 1=>5V, 2=>10V 3=>4mA, 4=>12mA, 5=>20mA
	301	Analogue output minimum on channel 1	
	302	Analogue output maximum on channel 1	
channel 2	303	Analogue output setting on channel 2	0=>0V, 1=>5V, 2=>10V 3=>4mA, 4=>12mA, 5=>20mA
	304	Analogue output minimum on channel 2	
	305	Analogue output maximum on channel 2	
CP 200	306	Activation / Deactivation of purge mode	00 or 01
	307	Working time of each purge	from 01 to 60 seconds
	308	Frequency of each purge	from 01 to 9999 minutes
	309	Time-delay before and after purge	from 00 to 60 seconds



## F400

### Code Description

400 Audible alarm  
 401 Relays security

### Available settings

0 or 1  
 0 (negative) or 1 (positive)

#### ALARM 1

402 Channel selection for alarm 1  
 403 Alarm 1 type selection

1=>channel 1, 2=> channel 2  
 0=>inactive  
 1=> setpoint 1, setpoint 2 and time-delay  
 2=> setpoint 1, time-delay and rising action  
 3=> setpoint 1, time-delay and falling action

404 Setpoint 1 of alarm 1  
 405 Setpoint 2 of alarm 1  
 406 Time-delay of alarm 1

from 0 to 60 seconds

#### ALARM 2

407 Channel selection for alarm 2  
 408 Alarm 2 type selection

1=>channel 1, 2=> channel 2  
 0=>inactive  
 1=> setpoint 1, setpoint 2 and time-delay  
 2=> setpoint 1, time-delay and rising action  
 3=> setpoint 1, time-delay and falling action

409 Setpoint 1 of alarm 2  
 410 Setpoint 2 of alarm 2  
 411 Time-delay of alarm 2

from 0 to 60 seconds

#### RELAY 1

412 Channel selection for Relay 1  
 413 Alarm type selection for Relay 1

1=>channel 1, 2=> channel 2  
 0=>inactive  
 1=> setpoint 1, setpoint 2 and time-delay  
 2=> setpoint 1, time-delay and rising action  
 3=> setpoint 1, time-delay and falling action

414 Setpoint 1 of Relay 1  
 415 Setpoint 2 of Relay 1  
 416 Time-delay of Relay 1

from 0 to 60 seconds

#### RELAY 2

417 Channel selection for Relay 2  
 418 Alarm type selection for Relay 1

1=>channel 1, 2=> channel 2  
 0=>inactive  
 1=> setpoint 1, setpoint 2 and time-delay  
 2=> setpoint 1, time-delay and rising action  
 3=> setpoint 1, time-delay and falling action

419 Setpoint 1 of Relay 2  
 420 Setpoint 2 of Relay 2  
 421 Time-delay of Relay 2

from 0 to 60 seconds



## F500

Code	Product	Description	Available settings
500	CP200	Measurement integration	from 0 to 9
500	TH200	Offset in humidity	-50,0 to +50,0
501	TH200	Offset in temperature (°C)	from -50,0 to +50,0
502	TH200	Offset in temperature (°F)	from -90,0 to +90,0

## F600

Code	Description	Available settings																		
600	Compensation temperature in °C*	-																		
601	Compensation temperature in °F*	-																		
603	Air velocity measurement mean*	<table border="1"> <thead> <tr> <th>Code</th> <th>Differential probe</th> </tr> </thead> <tbody> <tr> <td>00</td> <td>Pitot tube</td> </tr> <tr> <td>01</td> <td>DEBIMO blade</td> </tr> <tr> <td>02</td> <td>Other differential probe</td> </tr> </tbody> </table>	Code	Differential probe	00	Pitot tube	01	DEBIMO blade	02	Other differential probe										
Code	Differential probe																			
00	Pitot tube																			
01	DEBIMO blade																			
02	Other differential probe																			
604	Air velocity coefficient value*	from 0,0001 to 9,9999																		
605	Air velocity correction coefficient	from 0,200 to 2,000																		
606	Section type selection	<table border="1"> <thead> <tr> <th>Code</th> <th>Section type</th> </tr> </thead> <tbody> <tr> <td>00</td> <td>Rectangular</td> </tr> <tr> <td>01</td> <td>Circular</td> </tr> <tr> <td>02</td> <td>Airflow coefficient</td> </tr> </tbody> </table>	Code	Section type	00	Rectangular	01	Circular	02	Airflow coefficient										
Code	Section type																			
00	Rectangular																			
01	Circular																			
02	Airflow coefficient																			
607	Section length in mm	from 0 to 3000 mm																		
608	Section width in mm	from 0 to 3000 mm																		
609	Section diameter in mm	from 0 to 3000 mm																		
610	Section length in inch	from 0 to 118.11 inch																		
611	Section width in inch	from 0 to 118.11 inch																		
612	Section diameter in inch	from 0 to 118,.1 inch																		
613	Airflow coefficient*	from 0.1 to 9999.9																		
614	Units of pressure for the pressure calculation*	<table border="1"> <thead> <tr> <th colspan="3">CP201 and 202 CP203 and 204</th> </tr> </thead> <tbody> <tr> <td>01</td> <td>Pa</td> <td>mbar</td> </tr> <tr> <td>02</td> <td>mmH<sub>2</sub>O</td> <td>inWg</td> </tr> <tr> <td>03</td> <td>inWg</td> <td>KPa</td> </tr> <tr> <td>04</td> <td>mbar</td> <td>PSI</td> </tr> <tr> <td>05</td> <td>mmHg</td> <td>mmHg</td> </tr> </tbody> </table>	CP201 and 202 CP203 and 204			01	Pa	mbar	02	mmH <sub>2</sub> O	inWg	03	inWg	KPa	04	mbar	PSI	05	mmHg	mmHg
CP201 and 202 CP203 and 204																				
01	Pa	mbar																		
02	mmH <sub>2</sub> O	inWg																		
03	inWg	KPa																		
04	mbar	PSI																		
05	mmHg	mmHg																		

CP 200 - CTV 210