

Serial No.	H-V003-E-10
------------	-------------

**contents**

# 3-Way Ball Valve Type 23



**User's Manual**





- (1) Be sure to read following warranty clauses of our product..... 1
- (2) General operating instructions..... 2
- (3) General instruction for transportation, unpacking and storage..... 3
- (4) Name of parts..... 4
- (5) Working pressure vs. temperature..... 6
- (6) Specification of limit switch..... 7
- (7) Installation procedure..... 7
- (8) Connection of limit switch procedure..... 12
- (9) Operating procedure..... 14
- (10) Method of adjusting face pressure between ball and seat..... 15
- (11) Disassembling method for replacing parts..... 16
- (12) Mounting actuator..... 17
- (13) Inspection items..... 18
- (14) Troubleshooting..... 18
- (15) Handling of residual and waste materials..... 18

This user's guide contains very important information for the proper installation, maintenance and safe use of an ASAHI AV Product. Please store this manual in an easily accessible location.

<Warning & Caution Signs>

 Warning	This symbol reminds the user to take caution due to the potential for serious injury or death.
 Caution	This symbol reminds the user to take caution due to the potential for damage to the valve if used in such a manner.

<Prohibited & Mandatory Action Signs>

	Prohibited: When operating the valve, this symbol indicates an action that should not be taken.
	Mandatory action: When operating the valve, this symbol indicates mandatory actions that must be adhered to.

**(1) Be sure to read the following warranty clauses of our product**

- Always observe the specifications of and the precautions and instructions on using our product.
- We always strive to improve product quality and reliability, but cannot guarantee perfection. Therefore, should you intend to use this product with any equipment or machinery that may pose the risk of serious or even fatal injury, or property damage, ensure an appropriate safety design or take other measures with sufficient consideration given to possible problems. We shall assume no responsibility for any inconvenience stemming from any action on your part without our written consent in the form of specifications or other documented approval.
- The related technical documents, operation manuals, and other documentation prescribe precautions on selecting, constructing, installing, operating, maintaining, and servicing our products. For details, consult with our nearest distributor or agent.
- Our product warranty extends for one and a half years after the product is shipped from our factory or one year after the product is installed, whichever comes first. Any product abnormality that occurs during the warranty period or which is reported to us will be investigated immediately to identify its cause. Should our product be deemed defective, we shall assume the responsibility to repair or replace it free of charge.
- Any repair or replacement needed after the warranty period ends shall be charged to the customer.
- The warranty does not cover the following cases:
  - (1) Using our product under any condition not covered by our defined scope of warranty.
  - (2) Failure to observe our defined precautions or instructions regarding the construction, installation, handling, maintenance, or servicing of our product.
  - (3) Any inconvenience caused by any product other than ours.
  - (4) Remodeling or otherwise modifying our product by anyone other than us.
  - (5) Using any part of our product for anything other than the intended use of the product.
  - (6) Any abnormality that occurs due to a natural disaster, accident, or other incident not stemming from something inside our product.

## (2) General operating instructions



Warning



- Using a positive-pressure gas with our plastic piping may pose a dangerous condition due to the repellent force particular to compressible fluids even when the gas is under similar pressures used for liquids. Therefore, be sure to take the necessary safety precautions such as covering the piping with protective material. For inquiries, please contact us. For conducting a leak test on newly installed piping, be sure to check for leaks under water pressure. If absolutely necessary to use a gas in testing, please consult your nearest service station beforehand.

- Certain liquid such as H<sub>2</sub>O<sub>2</sub>, NaClO, etc may be prone to vaporization (Off-Gassing) which may cause irregular pressure increases, which may destroy the valve.



Caution



- Do not step on or apply excessive weight on valve. (It can be damaged.)

- Do not use the valve to fluid containing slurry. (The valve will not operate properly.)

- Do not use the valve in conditions where the fluid may have crystallized.

(The valve will not operate properly.)



- Keep the valve away from excessive heat or fire. (It can be damaged, or destroyed.)

- Always operate the valve within the pressure vs. temperature range.

(The valve can be damaged or deformed by operating beyond the allowable range.)

- Allow sufficient space for maintenance and inspection.

- Select a valve material that is compatible with the media. For chemical resistance information, refer to “CHEMICAL RESISTANCE ON ASAHI AV VALVE”.

(Some chemicals may damage incompatible valve materials.)

- Keep the valve out of direct sunlight, water and dust. Use cover to shield the valve.

(The valve will not operate properly.)

- Perform periodic maintenance.

(Leakage may develop due to temperature changes or periods of prolonged storage, rest, or operation.)

### (3) General instructions for transportation, unpacking and storage



Caution



- This valve is not designed to handle impacts of any kind. Avoid throwing or dropping the valve.

- Avoid scratching the valve with any sharp object.

- Do not over-stack cardboard shipping boxes. Excessively stacked packages may collapse.

- Avoid contact with any coal tar creosote, insecticides, vermicides or paint.

(These chemicals may cause damage to the valve.)

- When transporting a valve, do not carry it by the handle.



- Store products in their corrugated cardboard boxes. Avoid exposing products to direct sunlight, and store them indoors (at room temperature). Also avoid storing products in areas with excessive temperatures. (Corrugated cardboard packages become weaker as they become wet with water or other liquid. Take care in storage and handling.)

- After unpacking the products, check that they are defect-free and meet the specifications.

**(4) Name of parts**

Nominal size 15-50mm (1/2"-2")

No.	DESCRIPTION	No.	DESCRIPTION
[1]	Body	[8]	O-ring (A)
[2]	Ball	[9]	O-ring (B)
[3]	Carrier	[10]	O-ring (C)
[4b]	End Connector (Flange End Type)	[11]	O-ring (D)
[4c]	End Connector (Socket End Type)	[12]	O-ring (E)
[4d]	End Connector (Threaded End Type)	[13]	Stop Ring
[4e]	End Connector (Spigot End Type)*	[14]	Handle
[5]	Union Nut	[15]	Tapping Screw (A)
[6]	Stem	[19]	Extension Stem
[7]	Seat	[19a]	Tapping Screw (B)

\*Nominal size of 32mm (1 1/4") is excluded.

Nominal size 65-100mm (2 1/2"-4")

No.	DESCRIPTION	No.	DESCRIPTION
[1]	Body	[8]	O-ring (A)
[2]	Ball	[9]	O-ring (B)
[3]	Carrier	[10]	O-ring (C)
[4b]	End Connector (Flange End Type)	[11]	O-ring (D)
[4c]	End Connector (Socket End Type)	[12]	O-ring (E)
[4d]	End Connector (Threaded End Type)	[13]	Stop Ring
[4e]	End Connector (Spigot End Type)*	[14]	Handle
[5]	Union Nut	[15]	Tapping Screw (A)
[6]	Stem	[19]	Extension Stem
[7]	Seat	[19a]	Tapping Screw (B)

\*Nominal size of 65mm (2 1/2") is excluded.

Nominal size 15-100mm (1/2"-4") with limit switch (SL1-A) (option)

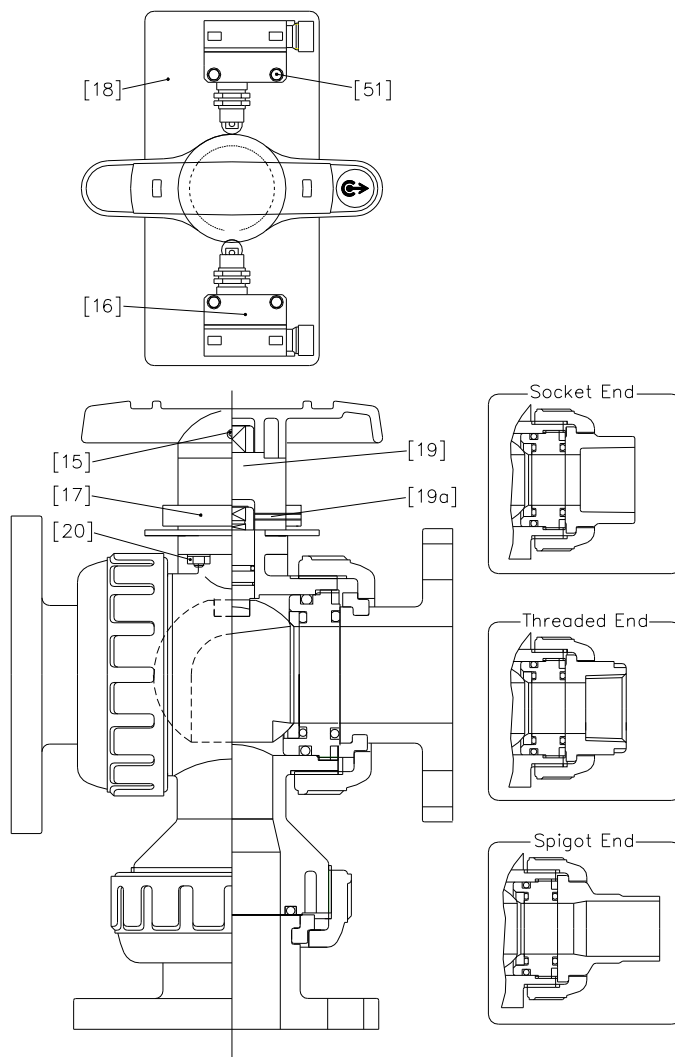

No.	DESCRIPTION	No.	DESCRIPTION
[15]	Tapping Screw (A)	[19]	Extension Stem
[16]	Limit Switch	[19a]	Tapping Screw (B)
[17]	Limit Switch Rod	[20]	Bolt·Nut (A)
[18]	Bracket (A)	[51]	Bolt·Nut (F)

(5) Working pressure vs. temperature

Nominal size: 15mm-50mm (1/2"-2")

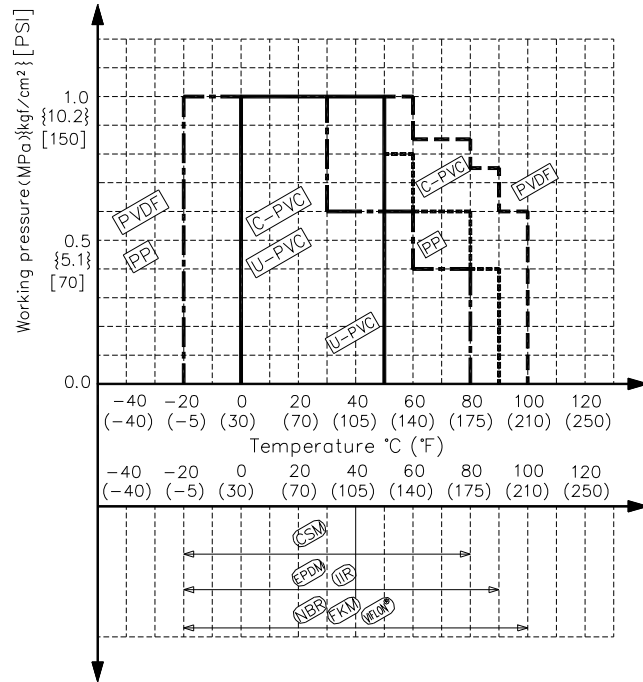

Nominal size: 65mm-100mm (2 1/2"-4")

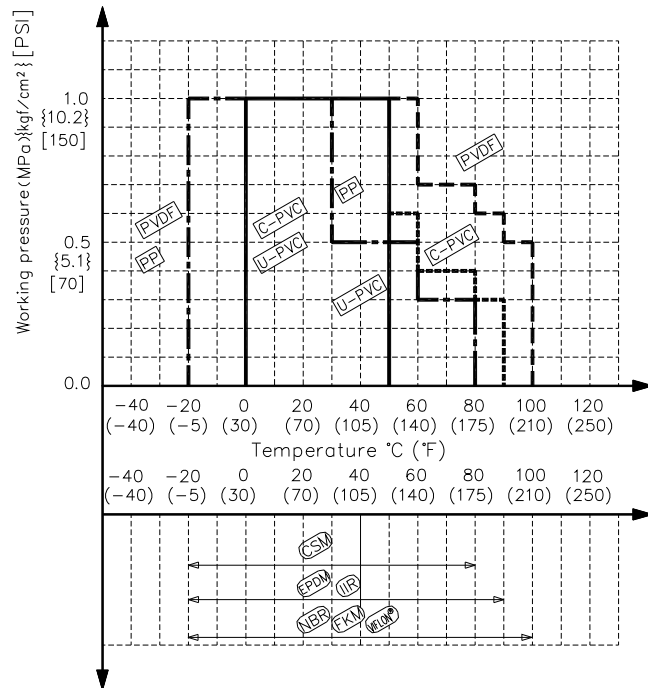

**(6) Specification of limit switch (option)**

Nominal Size	Type Code	Protection Grade
15-100mm (1/2"-4")	SL1-A	IP67







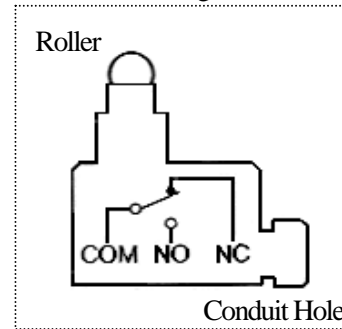

Limit Switch Rating

Rate Voltage (V)	Resistive Load (A)	Inductive Load (A)
AC125	5	3
AC250	5	3
DC8	5	3
DC14	5	3
DC30	5	3
DC115	0.5	0.1
DC230	0.25	0.05

Connection Diagram





**(7) Installation procedure**

-   - Be sure to conduct a safety check on all hand and power tools to be used before beginning work.
-  - Wear protective gloves and safety goggles as fluid remain in the valve even if the pipeline is empty. (You may be injured.)
-   - When installing a pipe support by means of a U-band or something similar, take care not to over-tighten. (Excessive force may damage the pipe.)
-  - Take care not to over-tighten the Union Nut. (The valve can be damaged.)
-  - Do not use the pipe wrench. (The valve can be damaged.)
-  - When installing pipes and valves, ensure that they are not subjected to tension, compression, bending, impact, or other excessive stress.
- When installing, disassembling, or reassembling the piping, fix the End Connector.
- Before a water test, be sure that the Union Nut is tightly fastened.
- Fasten the Union Nut while avoiding the parallelism and axial misalignment of the flange surface.
- When connecting an ASahi AV Valve to metal piping, take care not to let the pipe stress on the ASahi AV Valve.



**Flanged type** (Material: PVC, C-PVC, PP, PVDF)



**Caution**   - Use flat faced flanges for connection to AV Valves.  
 - Ensure that the mating flanges are of the same standards.  
 - Be sure to use sealing gaskets (AV Gasket), bolts, nuts, and washers and tighten them to specified torques.  
 (When a non-AV gasket is used, a different tightening torque specification should be followed.)

**Necessary items**

- Torque wrench
- AV gasket
- Spanner wrench
- Bolt, Nut, Washer (For many flanges specification)
- Strap wrench

**Procedure**

- 1) Set the AV gasket between the flanges.
- 2) Insert washers and bolts from the pipe side, insert washers and nuts from the valve side, then temporarily tighten them by hand.

**Caution**   - The parallelism and axial misalignment of the flange surface should be under the values shown in the following table to prevent damage the valve. (A failure to observe them can cause destruction due to stress application to the pipe)

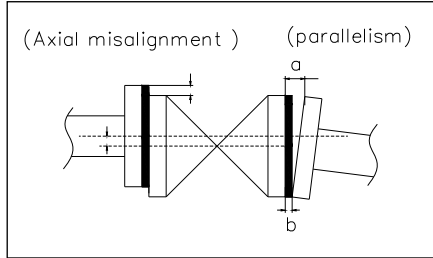

Unit : mm (inch)

Nom. Size	Axial Misalignment	Parallelism (a-b)
15-32mm (1/2"-1 1/4")	1.0 (0.04)	0.5 (0.02)
40-80mm (1 1/2"-3")	1.0 (0.04)	0.8 (0.03)
100mm (4")	1.0 (0.04)	1.0 (0.04)



(Axial misalignment) (parallelism)

- 3) Using a torque wrench, tighten the bolts and nuts gradually to the specified torque in a diagonal manner (Refer to Fig.1).

**Caution**   - Tighten the bolts and nuts gradually with a torque wrench to the specified torque level in a diagonal manner.

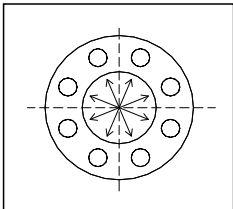

Recommended torque value		Unit: N·m (kgf·cm) [lb·inch]							
Nom. Size	15mm (1/2")	20mm (3/4")	25mm (1")	32mm (1 1/4")	40mm (1 1/2")	50mm (2")	65mm (2 1/2")	80mm (3")	100mm (4")
PTFE·PVDF coated	17.5 (179)	17.5 (178)	20.0 (204)	20.0 (204)	20.0 (204)	22.5 (230)	22.5 (230)	30.0 (306)	30.0 (306)
	[155]	[155]	[177]	[177]	[177]	[200]	[200]	[266]	[266]
Rubber	8.0 (82)	8.0 (82)	20.0 (204)	20.0 (204)	20.0 (204)	22.5 (230)	22.5 (230)	30.0 (306)	30.0 (306)
	[71]	[71]	[177]	[177]	[177]	[200]	[200]	[266]	[266]

\*Be sure to set the union nut [5] when it was removed or loosen from body [1].

- 1) The o-ring (A) [8] should be set on surface of the end connector [4b].
- 2) The end connector [4b] must be put onto the carrier, then ensure that the o-ring (A) [8] is being between the end connector [4b] and the carrier.
- 3) Tighten the union nut [5] hardly with hand.
- 4) Screw the union nut [5] on the body [1] by quarter or half turn using a strap wrench without damaging it.

### Threaded type (Material : PVC, C-PVC, PP, PVDF)



Caution

- Avoid excessive tightening. (The valve can be damaged.)



- Make sure that the threaded connections are plastic x plastic. (Metallic thread can cause damage.)

- Wrap the threaded joints on our plastic piping with sealing tape. Using a liquid sealing agent or liquid gasket may cause stress cracks (Environmental Stress Cracking). Our product warranty shall not apply in case of said use, even when said use is unavoidable.

#### Necessary items

● Sealing tape

● Strap wrench



● Spanner wrench

#### Procedure

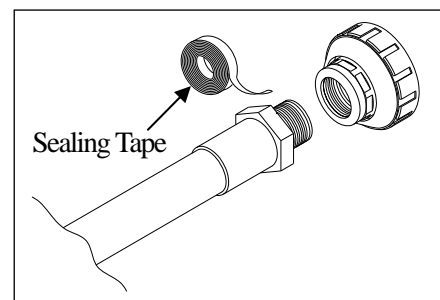

- 1) Wind a sealing tape around the external thread of joint, leaving the end (about 3mm) free.
- 2) Loosen the union nut [5] with a strap wrench.
- 3) Remove the union nut [5] and the end connector [4d].
- 4) Tighten the external thread of the joint and the end connector [4d] hardly with hand.
- 5) Using a spanner wrench, screw in the end connector [4d] by turning 180° -360° carefully without damaging it.
- 6) Make sure that the O-ring (A) [8] is mounted.
- 7) Set the end connector [4d] and union nut [5] directly on the body without allowing the O-ring (A) [8] to come off.
- 8) Tighten the union nut [5] hardly with hand.
- 9) Using a strap wrench tighten union nuts uniformly on each side approx 90° -180° turns, 1/4 to 1/2 turns.



Socket type (Material : PVC, C-PVC)

  - When using an adhesive, ventilate the space sufficiently, prohibit the use of a fire in the vicinity, and do not inhale adhesive vapors directly.

- If an adhesive gets into contact with your skin, wash it off immediately. If you feel sick or find any anomaly, receive a physician's diagnosis and take appropriate measures promptly.

  - Take care in doing work at low temperatures. Solvent vapors are hard to evaporate and are likely to remain. (Solvent cracks may occur, damaging the equipment.) After assembling the piping system, open both ends of the piping and use a fan (of the Low-Voltage Type) or something similar to ventilate the space, thus removing the solvent vapors.

 - Use the appropriate Asahi AV cement.

- Conduct a water test at least 24 hours after joining the pipes with an adhesive.



Necessary items

● Adhesive for hard vinyl chloride pipes

● Strap wrench

Procedure

- 1) Loosen the union nut [5] with a strap wrench.
- 2) Remove the union nut [5] and end connector [4c]
- 3) Lead the union nut through the pipe.
- 4) Clean the hub part of the end connector [4c] by wiping the waste cloth.
- 5) Apply adhesive evenly to the hub part of the end connector [4c] and the pipe spigot.



  - Do not apply more adhesive than necessary. (The valve can be damaged due to solvent cracking.)

Caution

Adhesive quantity (guideline)

Nom. Size	15mm (1/2")	20mm (3/4")	25mm (1")	32mm (1 1/4")	40mm (1 1/2")	50mm (2")	65mm (2 1/2")	80mm (3")	100mm (4")
Quantity(g)	1.0	1.3	2.0	2.4	3.5	4.8	6.9	9.0	13.0

- 6) After applying adhesive, insert the pipe quickly to the end connector [4c] and leave it alone for at least 60 seconds.

  - Do not under any circumstances try to insert a pipe into another fitting or valve by striking it, which may break the piping.

Warning

- 7) Wipe away overflowing adhesive.
- 8) Make sure that O-ring (A) [8] is mounted
- 9) Set the end connector [4c] and union nut [5] directly on the body without allowing the O-ring (A) [8] to come off.

- 10) Tighten the union nut [5] hardly with hand.
- 11) Using a strap wrench tighten union nuts uniformly on each side approx  $90^{\circ}$  - $180^{\circ}$  turns, 1/4 to 1/2 turns.

Socket type (Material : PP, PVDF)

Necessary items

- Strap wrench
- Sleeve welder or automatic welding machine
- User's manual for sleeve welder or automatic welding machine

Procedure

- 1) Loosen the union nut with a strap wrench.
- 2) Remove the union nut [5] and the end connector.
- 3) Lead the union nut [5] through the pipe.
- 4) For the next step, refer to the user's manual for the sleeve welder or the automatic welding machine.
- 5) After welding, make sure that the O-ring (A) [8] is mounted.
- 6) Set the end connector [4c] and the union nut [5] directly without allowing the O-ring (A) [8] to come off.
- 7) Tighten the union nut [5] hardly with hand.
- 8) Using a strap wrench tighten union nuts uniformly on each side approx  $90^{\circ}$  - $180^{\circ}$  turns, 1/4 to 1/2 turns.

**Spigot type** (Material : PVDF)





Necessary items

- Strap wrench
- Automatic welding machine
- User's manual for automatic welding machine

Procedure

- 1) Loosen the union nut with a strap wrench.
- 2) Remove the union nut [5] and the end connector.
- 3) Lead the union nut [5] through the pipe.
- 4) For the next step, refer to the user's manual for the sleeve welder or the automatic welding machine.
- 5) After welding, make sure that the O-ring (A) [8] is mounted.
- 6) Set the end connector [4c] and the union nut [5] directly without allowing the O-ring (A) [8] to come off.
- 7) Tighten the union nut [5] hardly with hand.
- 8) Using a strap wrench tighten union nuts uniformly on each side approx 90° -180° turns, 1/4 to 1/2 turns.

**(8) Connection of limit switch procedure (option)**

-   - Shut down the power on the equipment before connecting wires. There are risks of electrical shock depending on the level of operating voltage.
- Warning**
-   - Connect the cables by using insulated sheathed crimping terminals in such a way as not to contact the cover or housing. (Contact of a crimping terminal with the cover may disable the cover from being closed or may cause a ground fault.)
- Caution**
- Be sure that the terminal cover and body cover are put on during the operation.

Necessary items

- Screw driver (+)
- Screw driver (-)
- Connector (G1/2)
- Wire stripper
- Terminal crimping tool

Procedure

- 1) Adjust a cable as shown in the figure below. (When installing a crimp style terminal on the lead wire, use crimp style terminals with insulation sleeve (M3) so that, its does not contact the housing and other crimp style terminals.)

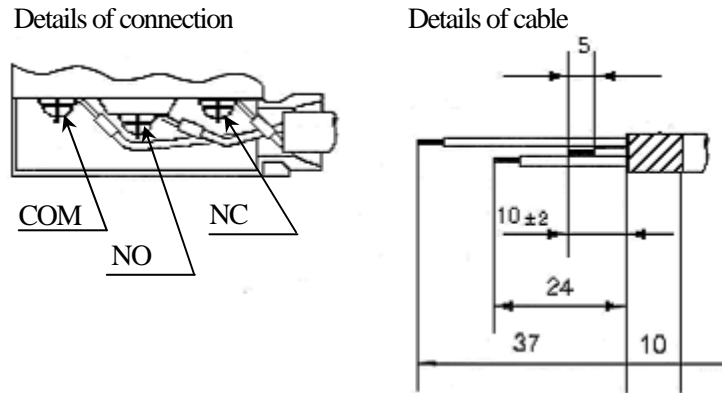

- 2) Remove the terminal cover from the housing by using a screw driver (-)
- 3) Draw a cable through each part as shown in the figure below.

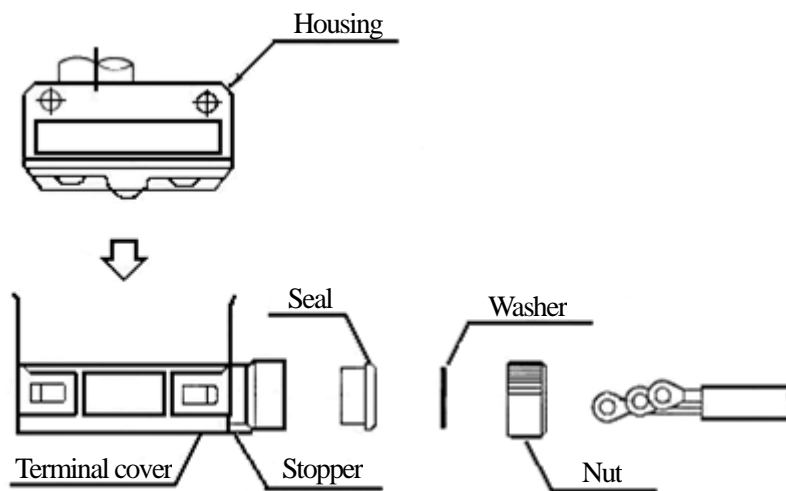

- 4) Connect the crimp style terminal to terminal board with a screw driver (+).
- 5) Attach the terminal cover to the housing.
- 6) Set the seal and washer, and tighten the nut to the terminal cover.

(9) Operating procedure

-  **Caution**
- Do not use the valve to fluid containing slurry.  
(The valve will not operate properly.)
  - The installed valve must never be opened or closed when foreign matter such as sand is present in the pipeline.
  - When operating the handle, be sure to do so with your hand.  
(Using a tool may damage the handle.)
  - Before opening or closing a lubricant free product, be sure to apply water.

Turn the handle gently to open or close.

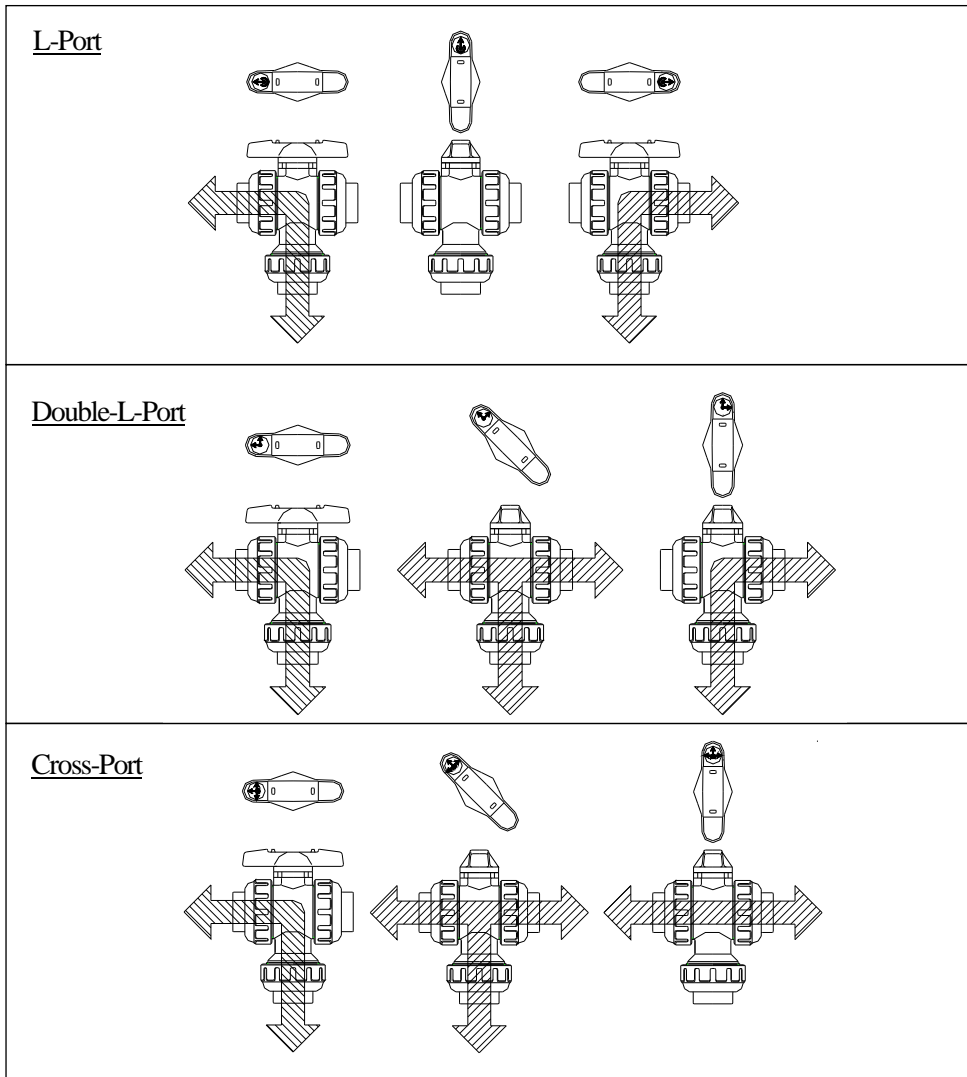

(10) Method of adjusting face pressure between ball and seat

 **Caution**

- Take care not to over-tighten the Union Nut. (The valve can be damaged.)
- Do not use the pipe wrench. (The valve can be damaged.)
- Wear protective gloves and safety goggles as fluid remain in the valve even if the pipeline is empty. (You may be injured.)

**Necessary items**

- Strap wrench
- Safety goggles
- Protective gloves
- Screwdriver (+) (only with nominal size 65-100mm (2 1/2"-4"))



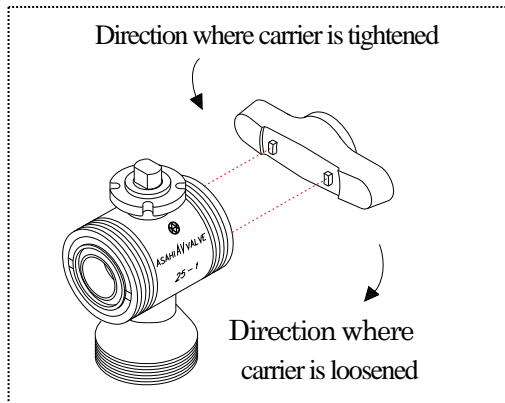
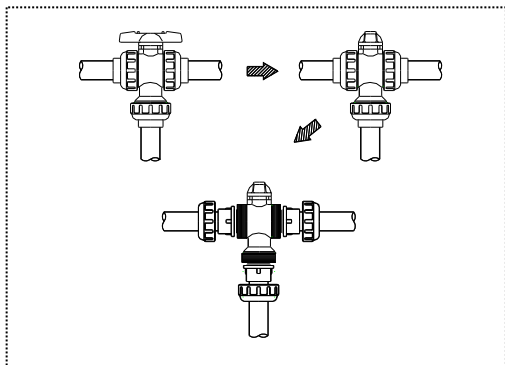

Procedure

- 1) Completely discharge fluid from pipes.
- 2) Turn the handle to full close.
- 3) Loosen the right union nut and the left one [5] with a strap wrench.
- 4) Remove the body part from piping system.
- 5) Pull the handle off the body part. As for nominal size 65-100mm (2 1/2"-4"), loosen the screw [15] properly with a screwdriver before pulling it off.
- 6) Engage the upper convex part of the handle with the concave part of the union [3]. Adjust the unions on both sides.
- 7) Make an adjustment by turning the union clockwise (to tighten it) or counter clockwise (to loosen it).
- 8) Make sure that the handle can be operated smoothly.
- 9) Assemble the valve by following the above procedure in the reverse order, starting at 6).





**(11) Disassembling method for replacing parts**

-   - Be sure to conduct a safety check on all hand and power tools to be used before beginning work.
- Warning** - Wear protective gloves and safety goggles as fluid remain in the valve even if the pipeline is empty. (You may be injured.)
- Do not change or replace valve parts under line pressure.
-   - Take care not to over-tighten the Union Nut. (The valve can be damaged.)
- Caution** - Do not use the pipe wrench. (The valve can be damaged.)
-  - When installing, disassembling, or reassembling the piping, fix the End Connector.
- Before a water test, be sure that the Union Nut is tightly fastened.
- Fasten the Union Nut while avoiding the parallelism and axial misalignment of the flange surface.
- When connecting an ASahi AV Valve to metal piping, take care not to let the pipe stress on the ASahi AV Valve.

- Necessary items
- Strap wrench
  - Safety goggles
  - Protective gloves

<Disassembly>

Procedure

- 1) Completely discharge fluid from pipes.
- 2) Turn the handle to full close.
- 3) Loosen the right union nut and the left one [5] with a strap wrench.
- 4) Remove the body part from piping system.
- 5) Pull the handle off the body part.  
As for nominal size 65-100mm (2 1/2"-4"), loosen the screw [15] properly with a screwdriver before pulling it off.
- 6) Engage the upper convex part of the handle with the concave part of the union. Adjust the unions on both sides.
- 7) In the engaged state, turn the handle [14] counter clockwise to loosen it and remove the union [3].
- 8) Remove the seat [7] carefully by hand without damaging it.
- 9) Push out the ball [2] by hand.
- 10) Push out the stem [6] from the top flange side to the body side.

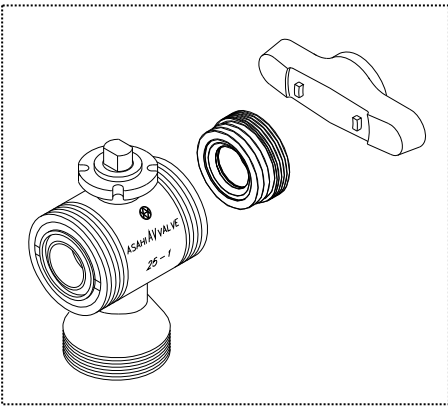
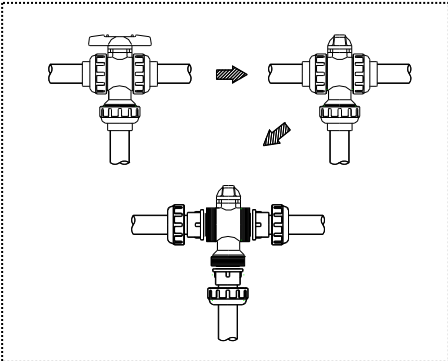

<Assembly>

Procedure

Carry out the assembly work in the reverse procedure from item 10)



Caution

- Before installing the Teflon seat on the valve, check the seat for its front and back.

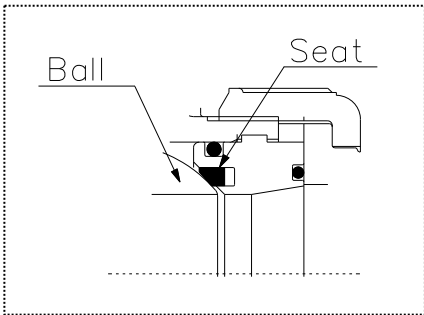

(12) Mounting actuator (option)



Attach actuator to the top flange

Procedure

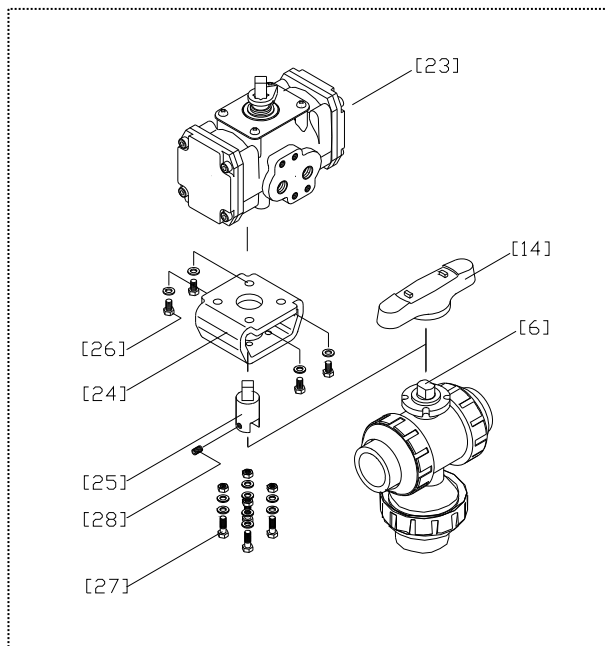
- 1) Remove the handle [14].  
As for nominal 80mm-100mm, tighten the screw [15] properly before removing it.
- 2) Fix the stand [24] to actuator [23] with bolt (A).
- 3) Fix the stem 6 to the joint [25] with screw (B) [28].
- 4) Engage the joint [25] with actuator [23].
- 5) Fix the stand [24] to the top flange with bolt-nut (B) [27].
- 6) Make sure that the valve works smoothly, by operating actuator [23] by hand.



(13) Inspection items

  - Perform periodic maintenance. (Leakage may develop due to temperature changes or over periods of prolonged storage, rest or operation.)



Inspect the following items;

(1)	Check for any flaw, cracks, or deformation on the outside.
(2)	Check whether fluid leaks to the outside.
(3)	Check whether the cap nut has been loosened.
(4)	Check whether the handle can be operated smoothly.

(14) Troubleshooting

Problem	Cause	Treatment
Fluid leaks from the valve even when the valve is closed fully.	The carrier is loosened.	Adjust the face pressure between the ball and the seat. (Refer to page 15)
	The seat is scratched or worn.	Replace the seat with a new one.
	Foreign matter is in the valve.	Clean up.
	The ball is scratched or worn.	Replace the scratched ball with a new one.
Fluid leaks from the valve.	The union nut is loosened.	Tighten the union nut.
	The carrier is loosened.	Adjust the face pressure between the ball and the seat. (Refer to page 15)
	The O-ring is scratched or worn.	Replace the O-ring with a new one.
The handle can not be turned smoothly.	Foreign matter is in the valve.	Clean up.
	Deformation. (By heat etc.)	Replace the parts.
	The carrier is tightening too much.	Adjust the face pressure between the ball and the seat. (Refer to page 15)
The handle fails to engage.	The stem is broken.	Replace the stem with a new one.
	The engagement between the stem and the ball is broken.	Replace the stem and ball with new ones.

(15) Handling of residual and waste materials

  - Make sure to consult a waste treatment dealer for recommendations on the proper disposal of plastic valves. (Poisonous gas is generated when the valve is burned improperly.)

### 3-Way Ball Valves Type 23



ASAHI AV VALVES

---

**Distributor**

Asahi Organic Chemicals Industry's homepage

<http://www.asahi-yukizai.co.jp/en/>