

T8665A Chronotherm® IV Deluxe Programmable Wireless Thermostat

INSTALLATION INSTRUCTIONS

APPLICATION

The T8665 Chronotherm® IV Wireless Thermostat provides electronic control of 24 Vac heating and cooling systems. It must be used with a W8665 Receiver

Module. Refer to Table 1 for a general description of the thermostat. The T8665A Thermostats are battery-powered.

Table 1. T8665A Thermostat Description.

T8665	System	Changeover	System Selection	Fan Selection	Comments
A	Heat-Cool	Automatic	Heat-Off-Cool-Auto	On-Auto	System and fan selections are entered at keyboard.



MERCURY NOTICE

If this control is replacing a control that contains mercury in a sealed tube, do not place your old control in the trash.

Contact your local waste management authority for instructions regarding recycling and the proper disposal of the old thermostat.

INSTALLATION

Accessory Required (Not Included)

Select one of the receiver modules for your application:

- W8665A Receiver Module (RM) for single zone applications.
- W8665E RF Zone™ Panel for up to three zones.

When Installing this Product...

1. Read these instructions carefully. Failure to follow the instructions can damage the product or cause a hazardous condition.
2. Check the ratings given in the instructions and on the product to make sure the product is suitable for your application.
3. Installer must be a trained, experienced service technician.
4. After completing installation, use these instructions to check out the product operation.

Location

Install the thermostat about 5 ft (1.5m) above the floor in an area with good air circulation at average temperature. See Fig. 1.

Do not install the thermostat where it can be affected by:

- drafts, or dead spots behind doors and in corners.
- hot or cold air from ducts.
- radiant heat from sun or appliances.
- concealed pipes and chimneys.
- unheated (uncooled) areas such as an outside wall behind the thermostat.

Wallplate Installation

The thermostat can be mounted horizontally on the wall.

1. Position and level the wallplate (for appearance only). The thermostat functions correctly even when not level.
2. Use a pencil to mark the mounting holes. See Fig. 2.
3. Remove the wallplate from the wall and drill two 3/16 in. holes in the wall (if drywall) as marked. For firmer material such as plaster, drill two 7/32 in. holes.
4. Gently tap anchors (provided) into the drilled holes until flush with the wall.
5. Position the wallplate over the holes.
6. Loosely insert the mounting screws into the holes.
7. Tighten the mounting screws.



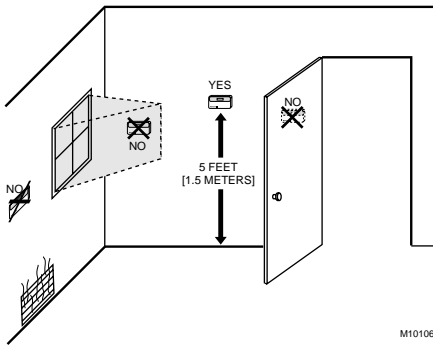

M10106

Fig. 1. Typical thermostat location.

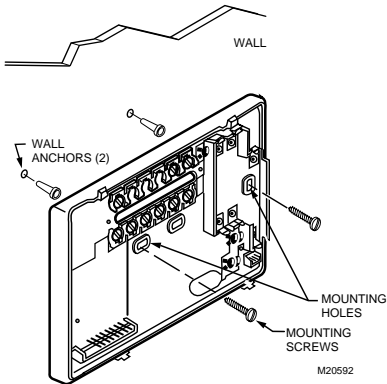

M20592

Fig. 2. Mounting the wallplate.

Mounting Thermostat

1. Engage tabs at the top of the thermostat and wallplate. See Fig. 3.
2. Press lower edge of case to close and latch.

NOTE: To remove the thermostat from the wall, first pull out at the bottom of the thermostat; remove top last.

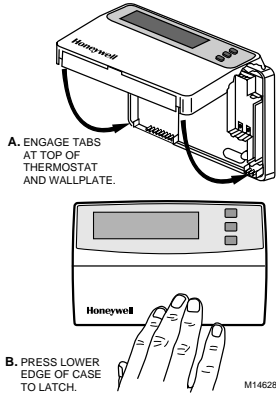

A. ENGAGE TABS AT TOP OF THERMOSTAT AND WALLPLATE.

B. PRESS LOWER EDGE OF CASE TO LATCH.

M14628

Fig. 3. Mounting thermostat on wallplate.

Using Thermostat Keys

The thermostat keys are used to:

- set current day and time.
- program times and setpoints for heating and cooling.
- temporarily override program temperatures
- display present setting,

- configure Installer Setup,
- check self-test,
- set the system operation,
- set the fan operation.

See Fig. 4 for key locations.

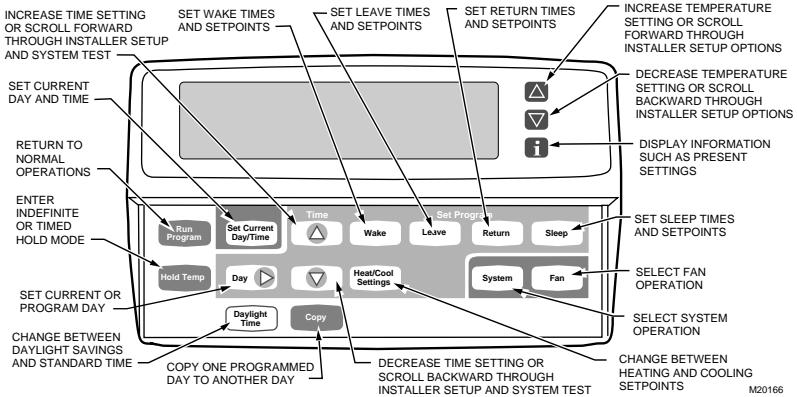

Fig. 4. T8665A key locations and descriptions.

Setting up T8665A to Send Signal to W8665A Receiver Module

The T8665A Thermostat must be set up to send signals to the W8665 Receiver Module. Use the W8665A Receiver for single-zone applications. Use the W8665E RF Zone™ Panel for up to three T8665A Thermostats for multizone applications.

Single Zone Applications (one T8665A/one W8665A)

1. Place the Zone 1 DIP switch on the W8665A Receiver to the On position.

NOTE: Observe that the Zone 1 LED on the W8665 flashes.

2. Press the thermostat Fan key to the On position. The receiver accepts the message, stores identity and then stops flashing the Zone 1 LED. The thermostat is now set up to send signals the W8665A Receiver.

NOTE: The word On and a fan blade  appear in the thermostat display to indicate the thermostat is calling for the fan to turn on.

3. Set the System and Fan keys to the desired locations.

NOTE: At any time, if you want to stop the thermostat from sending signals to the W8665 Receiver, simply turn the DIP switch to the Off position. Follow the instructions in steps above to set up the thermostat again to send signals to the W8665A Receiver.

Multizone Applications (Up to three T8665A/one W8665E)

IMPORTANT

The thermostats must be set up one zone at a time to ensure a unique address is used for each zone.

1. Place the Zone 1 DIP switch on the W8665E Receiver to the On position.

NOTE: Observe that the Zone 1 LED on the W8665 flashes.

2. Press the thermostat Fan key to the On position. The Receiver accepts the message, stores the identity of that zone, and stops flashing the Zone 1 LED. The thermostat is now set up to send signals to Zone 1 of the W8665E Receiver.

NOTE: The word On and a fan blade  appear in the thermostat display to indicate the thermostat is calling for the fan to turn on.

3. Set the System and Fan keys to the desired locations.

NOTE: At any time, if you want to stop the thermostat from sending signals to the W8665 Receiver, simply turn the DIP switch to the Off position. Follow the instructions in steps above to set up the thermostat again to send signals to the W8665E Receiver.

4. Repeat steps 1-3 for zones two and three.

- Attach the zone number stickers, included with the thermostat, onto the thermostat case on the inside of the thermostat cover. See Fig. 5.



Place one label inside each thermostat door.

M13426

Fig. 5. Zone stickers included with T8665A Thermostat.

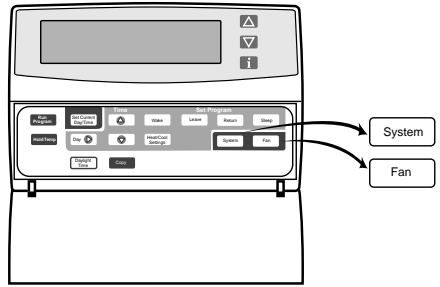

M14625

Fig. 6. Thermostat System and Fan key locations.

NOTE: Always press the keys with your fingertip or similar blunt tool. Sharp instruments like a pen or pencil point can damage the keyboard.

SETTINGS

System and Fan Settings

The system default setting is Heat and the fan default setting is Auto. Use the System and Fan keys to change the settings. See Fig. 6. The fan settings can be set for each program period individually. The system selection is for all the program periods.

System settings control the thermostat operation as follows:

Heat: The thermostat controls the heating.

Off: Both the heating and cooling are off.

Cool: The thermostat controls the cooling.

Auto: The thermostat automatically changes between heating and cooling operation, depending on the indoor temperature.

Fan settings control the system fan as follows:

On: Fan operates continuously.

Auto: Fan operates with equipment.

Programmed Temperature Settings

Refer to Table 2 for the default program. If the daytime energy savings period is not used, press the period key (Leave or Return) until the time is blank. The fan setting feature is available on select thermostat models. See Owner's Guide for complete instructions on changing the program.

Table 2. Default Program Settings.

Period	Time	Heat Setpoint	Cool Setpoint	Fan Setting
Wake	6:00 AM	70°F (21°C)	78°F (25.5°C)	Auto
Leave	8:00 AM	62°F (16.5°C)	85°F (29.5°C)	Auto
Return	6:00 PM	70°F (21°C)	78°F (25.5°C)	Auto
Sleep	10:00 PM	62°F (16.5°C)	82°F (28°C)	Auto

INSTALLER SETUP

NOTE: For most applications, the thermostat factory-settings do not need to be changed. Review the factory default settings in Table 3 and, if no changes are necessary, go to the Installer Self-Test section.

The Installer Setup is used to customize the thermostat to specific systems. Some of the options include temperature display and system changeover. Installer Setup numbers are listed in Table 3. The table includes all the configuration options and the factory-settings for the T8665.

A combination of key presses are required to use the Installer Setup feature:

- To enter the Installer Setup, press and hold the Information **i** key with the increase **▲** and decrease **▼** keys until the first number is displayed. All display segments appear for approximately three seconds before the number is displayed. See Fig. 7 and 8.
- To advance to the next Installer Setup, press the Time **▲** key.
- To change a setting, use the increase **▲** or decrease **▼** key.
- To scroll the Installer Setup numbers backward, press the Time **▼** key.
- To exit the Installer Setup, press Run Program.



Fig. 7. Display of all LCD segments.

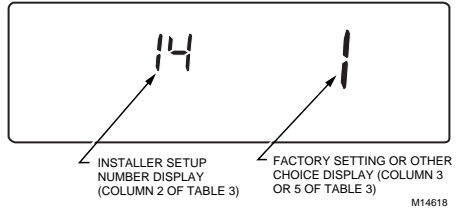

Fig. 8. Display of Installer Setup number and settings.



CAUTION

Equipment Damage Hazard.
Electric heat and heat pump systems must run with fan.
 Configure to 1 in Installer Setup number 2 to prevent equipment damage.

IMPORTANT

Only configured numbers are shown on the device. For example: If thermostat does not have a system key, Installer Setup Number 12 will not display. Review Table 3 factory settings and mark any desired changes in the Actual Settings column. When Installer Setup is complete, review the settings to confirm they Matchew system.

Table 3. Thermostat Installer Setup Options.

Select	Installer Setup Number (Press Time ▲ key to change)	Factory Setting		Other Choices (Press ▲ or ▼ key to change)		Actual Setting
		Display	Description	Display	Description	
Not used	1	—	—	—	—	—
Fan operation ^a	2	0	Conventional applications where equipment controls fan operation in heat mode	1	Heat pump or electric heat applications where thermostat controls fan operation in heat mode	
Not used	3	—	—	—	—	—
Heating cycle rate	4	6	6—6 cph used for conventional heat	1, 3 or 9	1—1 cph used for radiant floor heat, gravity system 3—3 cph used for hot water systems or high efficiency furnaces 9—9 cph used for electric heat systems	
Not used	5 thru 11	—	—	—	—	—
System setting adjustment	12	1	Manual changeover	0 or 2	0—Auto changeover 2—Auto only	
Adaptive Intelligent Recovery™ control	13	0	Adaptive Intelligent Recovery™ control is activated (system starts early so setpoint is reached by start of program period)	1	Conventional recovery (system starts recovery at programmed time)	—
Degree temperature display	14	0	Temperature is displayed in °F	1	Temperature is displayed in °C	
Not used	15	—	—	—	—	—
Clock format	16	0	12-hour clock format	1	24-hour clock format	
Not used	17 and 18	—	—	—	—	—
Extended fan operation in heating ^a	19	0	No extended fan operation after the call for heat ends	1	Fan operation is extended 90 seconds after the call for heat ends.	
Extended fan operation in cooling ^a	20	0	No extended fan operation after the call for cool ends	1	Fan operation is extended 90 seconds after the call for cool ends.	
Not used	21 thru 29	—	—	—	—	—
Deadband	30	3	Heating and cooling setpoints can be set no closer than 3°F (1.5°C)	4 thru 10	Heating and cooling setpoints can be set no closer than the chosen value: 4—4°F (2°C) 5—5°F (2.5°C) 6—6°F (3°C) 7—7°F (3.5°C) 8—8°F (4°C) 9—9°F (4.5°C) 10—10°F (5°C)	
Not used	31 and 32	—	—	—	—	—
Minimum off time for the compressor	33	5	five-minute minimum off time for the compressor	0 thru 4	Minimum number of minutes (0 thru 5) the compressor will be off between calls for the compressor	

Table 3. Thermostat Installer Setup Options. (Continued)

Temperature range stops in heating	34	90	Highest setpoint heating can be set to	40 to 89	Temperature range (1°F increments) heating setpoint can be set to	
Temperature range stops in cooling	35	45	Lowest setpoint cooling can be set to	46 to 99	Temperature range (1°F increments) cooling setpoint can be set to	
Not used	36	—	—	—	—	—
Temperature display adjustment	37	0	No difference in displayed temperature and actual room temperature	3 thru -3	1—Display adjusts to 1°F higher than actual room temperature 2—Display adjusts to 2°F higher than actual room temperature 3—Display adjusts to 3°F higher than actual room temperature -1—Display adjusts to 1°F lower than actual room temperature -2—Display adjusts to 2°F lower than actual room temperature -3—Display adjusts to 3°F lower than actual room temperature	
Furnace air filter timer (pushbutton System keys)	43	2	30 days (System run time)	0, 1, 3, 4	0—Off 1—10 days 3—60 days 4—120 days (Time is counted when heat, cool or fan is running.)	
Humidifier pad monitor	44	0	Off	1, 2, 3	1—90 days 2—180 days 3—365 days (Time is counted by calendar days in heat mode.)	
Ultraviolet air treatment (UV) system lamp monitor	45	0	Off	1	1—365 days (Time is counted by calendar days in any mode.)	

^a Number 2 must be set to 1 to extend fan operation.

IMPORTANT

Review the settings to confirm they match the system. Press Run Program to exit the Installer Setup. The thermostat has saved the Installer Setup changes and initiated a reset to operate using the new settings. Be sure to set the current day and time immediately.

Setting Current Day and Time

1. Press Set Current Day/Time.

NOTE: On initial powerup or after an extended power loss, 1:00 pm flashes on the display until a key is pressed.

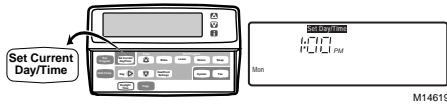

2. Press Day until the current day is displayed.

NOTE: Sun=Sunday, Mon=Monday, Tue=Tuesday, Wed=Wednesday, Thu=Thursday, Fri=Friday, Sat=Saturday.

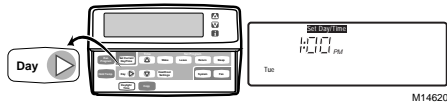

3. Press Time ▲ or Time ▼ until the current time is displayed.

NOTE: Tapping Set Current Day/Time changes the time in one-hour increments.

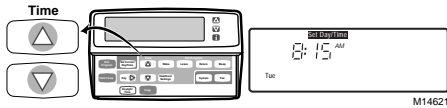

NOTE: If the current time is Daylight Savings Time, press Daylight Time until DST is displayed.

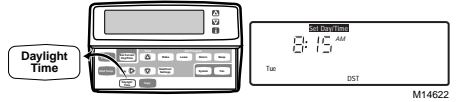

4. Press Run Program.

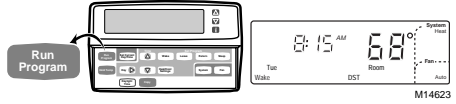

Viewing or Resetting Timer Settings

When the thermostat activates a timer, the thermostat flashes **Filter** until the timer resets.

1. Rest the timer by pressing the i key until the expired time is displayed.



2. Press the Time ▲ key to reset the timer.

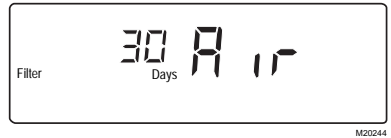

3. Press the Run Program key.

NOTE: You can view the number of days remaining at any time by pressing the i key three or four times. If more than one timer is active, all active timers show sequentially when pressing the i key several times.

INSTALLER SYSTEM TEST

Use the Installer System Test to check the thermostat operation. Refer to Table 4 for a list of the available Installer System Tests.



CAUTION

Equipment Damage Hazard.
Compressor damage can result if compressor is cycled too quickly.
 Be aware that compressor minimum off time is bypassed during the Installer System Test.



Fig. 9. LCD segments display.

To start the system test:

1. Press and hold increase ▲ and decrease ▼ at the same time until 10 appears.
2. Observe all segments of the display are displayed before the 10 appears. See Fig. 9 and 10.

Table 4. Tests Available in Installer System Test.

Test Number	System Test Description
10-19	Heating equipment can be turned on and off.
30-39	Cooling equipment can be turned on and off.
40-49	Fan equipment can be turned on and off.
60 0 to 60 19	Keyboard keys test.
70-79	Thermostat information, including date code and software versions, are displayed.



Fig. 10. Test number display.

Refer to Table 5 for the instructions and description of the specific tests.

NOTE: Press Time ▲ to advance to the next test and press Time ▼ to go back to the previous test. Press Run Program to exit the system test.

Table 5. Installer System Test Options.

Key to Press	Test Number	Description
Heating Equipment System Test		
Time	10	Enter heating equipment system test.
▲	11	Heat comes on. When Installer Setup number 2 is 1, the system fan is also energized.
▼	12	Heat and system fan turn off.
Cooling Equipment System Test		
Time	30	Change from heating to cooling equipment system test.
▲	31	Cool and system fan come on.
▼	30	Cool and system fan turn off.
Fan Equipment System Test		
Time	40	Change from cooling to fan equipment system test.
▲	41	Fan comes on.
▼	40	Fan turns off.
Key Operation System Test		
Time	60 2	Change from fan to key operation system test.

NOTE: Press any key and the displayed number will change. Press Time ▼ to go to the previous test and Time ▲ to go to the next test. The Run Program key will not exit this test. Press Time ▲ or Time ▼ and then the Run Program key to exit.

Thermostat Information

1. Press the Time key to access the thermostat information.



M14613

2. Press the increase ▲ key to display the production date code. The first two large digits are the month and the third digit is the last digit of the year (example: 027=February 1997).



M14614

3. Press the increase key ▲ again to display the software identification code. (Example: 02 = software ID code 2).



M14615

4. Press the increase key ▲ again to display the software revision number (example:001 = revision number 1).
5. Press the increase ▲ key again to display the EEPROM identification code (example: 314 = EEPROM ID 314).

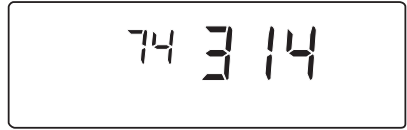



M14617

6. Press the Run Program key to exit the system test. The system test times out after four minutes without any key presses.

TROUBLESHOOTING GUIDE

For troubleshooting, see Table 6.

Table 6. Troubleshooting Guide.

Symptom	Possible Cause	Action
Display does not come on.	Thermostat is not being powered.	Check if batteries are present and installed correctly. — If batteries are present and installed correctly, replace thermostat.
Temperature display is incorrect.	Room temperature display has been reconfigured.	Enter Installer Setup number 37 and reconfigure the display.
	Thermostat is configured for °F or °C display.	Enter Installer Setup number 14 and reconfigure the display.
	Poor choice of thermostat location.	Relocate the thermostat.
Temperature settings do not change. (Example: Cannot set the heating higher or the cooling lower.)	The upper or lower temperature limits were reached.	Check the temperature setpoints: • Heating limits are 40 to 90°F (4.5 to 32°C) • Cooling limits are 48 to 99°F (7 to 35°C)
	The setpoint temperature range stops were configured.	Check Installer Setup numbers 34 and 35 and reconfigure the setpoint stops.
Heating does not come on.	Thermostat is calling for heat (flame icon is in display).	<ul style="list-style-type: none"> • Troubleshoot the W8665 Receiver Module. • Troubleshoot the heating equipment.
	Thermostat is not calling for heat (no flame icon is in display).	<ul style="list-style-type: none"> • Raise heating setpoint above room temperature. • Check if the W8665 is set up to receive signals from this thermostat. — Set up W8665 to receive signals.
	Thermostat minimum off time is activated.	Wait up to five minutes for the system to respond.
	System selection is not set to Heat.	Set system selection to Heat.
	Heating setpoint is below room temperature.	Check heating setpoint. Set heating setpoint to desired temperature.
Cooling does not come on.	Thermostat minimum off time is activated.	<ul style="list-style-type: none"> • Wait up to five minutes for the system to respond. • Enter Installer Setup number 33. Reconfigure minimum off time (if required).
	System selection is not set to Cool.	Set system selection to Cool.
	Cool setpoint is above room temperature.	Check cooling setpoint. Set cooling setpoint to desired temperature.
	Thermostat is calling for cool (snowflake icon is in display).	<ul style="list-style-type: none"> • Troubleshoot cooling equipment. • Troubleshoot W8665 Receiver Module.
	Thermostat is not calling for cool (no snowflake icon is in display).	<ul style="list-style-type: none"> • Check if the W8665 is set up to receive signals from the thermostat. — Set up W8665 to receive signals.
System on indicator ( = heat,  = cool) is displayed, but no warm or cool air is coming from the registers.	Fan operation set for 0 (conventional heat) when it should be set for 1 (electric heat).	Enter Installer Setup number 2 and reconfigure the fan operation.
	Conventional heating equipment turns on the fan when the furnace has warmed up to a setpoint.	Wait a minute after seeing the on indicator and then check the registers.
	Heating or cooling equipment is not operating.	Verify operation of heating or cooling equipment in self-test.
Thermostat backlight appears dim.	Backlight may fade over the life of the batteries.	<ul style="list-style-type: none"> • Wait until Replace Battery indicator is illuminated and replace batteries. • Replace batteries now.

FCCID: CFS8DL5800STAT

CANADA: 1748A12111

This device complies with Part 15 of the FCC Rules. Operation is subject to the following two conditions:

- (1) This device may not cause harmful interference, and
- (2) This device must accept any interference received, including interference that may cause undesired operation.

FEDERAL COMMUNICATIONS COMMISSION (FCC) STATEMENT

This equipment has been tested to FCC requirements and has been found acceptable for use. The FCC requires the following statement for your information:

This equipment generates and uses radio frequency energy and, if not installed and used properly; that is, in strict accordance with the manufacturer's instructions, may cause interference to radio and television reception. It has been type tested and found to comply with the limits for a Class B computing device in accordance with the specifications in Part 15 of FCC Rules, which are designed to provide reasonable protection against such interference in a residential installation. However, there is no guarantee that interference will not occur in a particular installation. If this equipment does cause interference to radio or television reception, which can be determined by turning the equipment off and on, the user is encouraged to try to correct the interference by one or more of the following measures:

- If using an indoor antenna, have a quality outdoor antenna installed.
- Reorient the receiving antenna until interference is reduced or eliminated.
- Move the radio or television receiver away from the receiver/control.
- Move the antenna leads away from any wire runs to the receiver/control.
- Plug the receiver/control into a different outlet so that it and the radio or television receiver are on different branch circuits.

If necessary, the user should consult the dealer or an experienced radio/television technician for additional suggestions. The user or installer may find the following booklet prepared by the Federal Communications Commission helpful:

"Interference Handbook"

This booklet is available under Stock No. 004-000-00450-7 from the US Government Printing Office, Washington, DC 20402.

The user shall not make any changes or modifications to the equipment unless authorized by the Installation Instructions or User's Manual. Unauthorized changes or modifications could void the user's authority to operate the equipment.

Honeywell

Automation and Control Solutions

Honeywell	Honeywell Limited-Honeywell Limitée
1985 Douglas Drive North	35 Dynamic Drive
Golden Valley, MN 55422	Scarborough, Ontario
	M1V 4Z9