

Hoefer SE900

Second Dimension Electrophoresis System

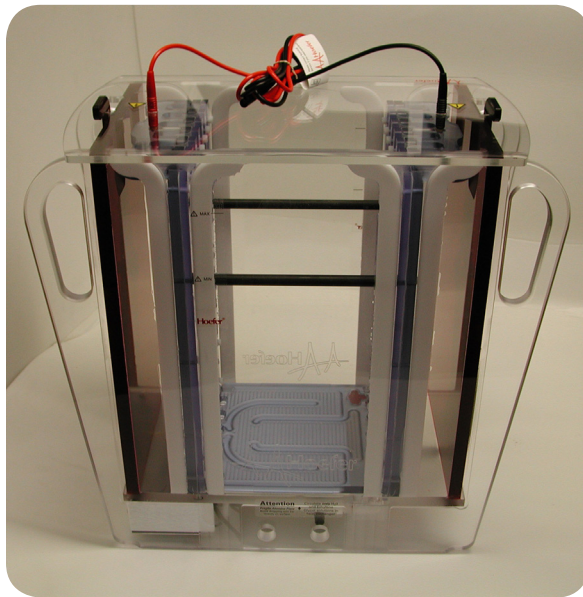

Page Finder

Important Information.....	ii
Waste Electrical And Electronic Equipment (WEEE)	vi
Function and Description	1
Specifications	2
Unpacking and Inventory.....	3
Operating Instructions.....	10
Using the Multiple Gel Caster.....	11
IPG Strip Equilibration	14
Page Separation	16
Care and Maintenance	19
Technical Service and Repair.....	19
Troubleshooting	20
Ordering Information	23
Appendix A: Theory and Recipes.....	24
Solutions	25
Gel Recipes	28
Appendix B: References.....	30

Important Information – English

- If this equipment is used in a manner not specified by Hoefer, Inc. the protection provided by the equipment may be impaired.
- This instrument is designed for indoor laboratory use only.
- Only accessories and parts approved or supplied by Hoefer, Inc. may be used for operating, maintaining, and servicing this product.
- Only use a power supply that is CE marked or safety certified by a nationally recognized testing laboratory.
- The safety lid must be in place before connecting the power supply leads to a power supply.
- Turn all power supply controls off and disconnect the power leads before removing the safety lid.
- Circulate only water or 50/50 water/ethylene glycol through the heat exchanger if so equipped. Do not connect the heat exchanger to a water tap or any coolant source where the water pressure is unregulated.
- Never introduce antifreeze or any organic solvent into any part of the instrument. Organic solvents will cause irreparable damage to the unit!
- Do not operate with buffer temperatures above the maximum specified technical specifications. Overheating will cause irreparable damage to the unit!

Důležité Informace – Czech

- Pokud by toto zařízení je použito způsobem, který není podle Hoefer, Inc. ochrana poskytována na základě zařízení může být narušena.
- Tento nástroj je určen pro vnitřní použití v laboratoři pouze.
- Pouze příslušenství a části schválen, nebo poskytnutých Hoefer, Inc. mohou být použity pro provoz, údržbu, a údržbě tohoto výrobku.
- zdroj napájení používají jen že je opatřen označením CE osvědčena nebo bezpečnost vnitrostátně uznanými zkušebními laboratoři.
- Bezpečnosti lid musí být zavedena před připojením napájecí zdroj napájení vede k.
- Turn veškeré napájení kontroly vypnuto a odpojit před odběrem energie vede bezpečnostní viko.
- Rozeslat pouze voda nebo 50/50 voda/ethylenglykolu prostřednictvím výměník tepla je li to vybavena. Nemají připojení výměník tepla s vodními setřepná nebo jakékoli chladicí kapaliny zdroje, kde tlak vody je neregulováno.
- Nikdy zavést prostředek proti zamrznutí nebo jakákoli organická rozpouštědla do jakékoli části z tohoto nástroje. Rozpustidlům způsobí nenapravitelné poškození jednotka!
- Nejsou provozována s pufrou teplotách nad maximální stanovenou technickými specifikacemi. Přehřátí způsobí nenapravitelné poškození jednotka!

Vigtig Information – Danish

- Hvis dette udstyr bruges i en måde ikke specificeret ved Hoefer, Inc. den beskyttelse, som er blevet forsynet af udstyret kan måske svækkes.
- Dette instrument er designet for indendørs laboratoriumbrug bare.
- Bare tilbehør og del godkendede eller forsynede ved Hoefer, Inc. kan måske bruges for drive, funktionsfejl, og betjening dette produkt.

- bruger Bare en strømforsyning, der er CE markerede eller sikkerhed, som er blevet attesteret af en, som nationalt er blevet anerkendt prøve laboratorium.
- Sikkerhedslåget må være på plads før forbindelse strømforsyningsblyet til en strømforsyning.
- Drejer alle strømforsyningskontroller af og afbryder kraftblyet før fjerning sikkerhedslåget.
- Cirkulerer bare vand eller 50/50 vand/ethylene glykol gennem varmeveksleren i så fald udrustet. Forbind ikke varmeveksleren til en vandhane eller nogen kølemiddelkilde hvor vandtrykket er unregulated.
- Introducerer Aldrig antifreeze eller noget organisk opløsningsmiddel ind i nogen del af instrumentet. Organiske opløsningsmidler vil forårsage uboelig skade til enheden!
- Driver ikke med stødpudetemperaturer over maksimummet specificerede tekniske specifikationer. Overhedning vil forårsage uboelig skade til enheden!

Belangrijke Informatie – Dutch

- Indien deze uitrusting in een manier wordt gebruikt die niet door Hoefer, Inc. is gespecificeerd de bescherming die door de uitrusting is verzorgd kan worden geschaad.
- Dit instrument is voor binnenlaboratoriumgebruik enkel ontworpen.
- Enkel onderdelen en delen keurden goed of leverden door Hoefer, Inc. kan voor het bedienen worden gebruikt, handhavend en onderhouden van dit product.
- gebruik Enkel een netvoeding die CE is markeerde of veiligheid die door een is gecertificeerd die nationaal is herkend testene laboratorium.
- Het veiligheidsdeksel moet in plaats voor het verbinden van de netvoeding leidt tot een netvoeding zijn.
- Doe alle netvoedingscontroles Uit en koppel los de machtleiding voor het verwijderen van het veiligheidsdeksel.
- Circuleer enkel water of 50/50 water/ethyleenglycol door de hitte exchanger zo ja uitrust. Verbind de hitte exchanger naar een waterkraan of koelmiddelbron niet waar de waterdruk niet geregulariseerd is.
- Stel Nooit antivriesmiddel of organische oplosmiddelen in deel van het instrument voor. Organische oplosmiddelen zullen onherstelbare schade aan de eenheid veroorzaken!
- Bedien niet met buffertemperaturen boven het maximum specificerde technische specificaties. Oververhitting zal onherstelbare schade aan de eenheid veroorzaken!

Tärkeää Tietoa – Finnish

- Jos tätä varusteita käytetään tavassa ei määritetty Hoefer, Inc. suojelu ehkäisty varusteille saattaa olla avuton.
- Tämä väline suunnitellaan sisälaboratoriokäyttöön vain.
- Vain lisävarusteet ja osat hyväksyivät tai toimitti Hoefer, Inc. oheen ää voi käyttää käyttämiselle, valvoalle, ja servicing tämä tuote.
- Vain käyttää käyttäjännettä joka on CE merkiksi tai turvallisuus joka on todistanut aidoksi ohi joka on kansallisesti tunnustettanut testaaminen laboratoriota.
- Turvallisuuskansi täytyy olla paikallaan ennen yhdistäminen

käyttäjännitelyijyjä käyttäjännitteeseen.

- Kiertää kaikki käyttäjännitevalvonnat ja irrottaa valtalijijyt ennen poistaminen turvallisuuskantta.
- Kiertää vain vesi tai 50/50 vesi/ethyleneä glycol siinä tapauksessa varustetun lämmönvaihtimen läpi. Älä yhdistä lämmönvaihdinta vesinäpautukseen eikä jäähdystynestelähteeseen, missä vesipaine on unregulated.
- Pakkasneste eikä orgaaninen liuotin väline osassa ei esitele Koskaan. Orgaaniset liuottimet aiheuttavat korvaamattoman vahingon yksikköön!
- Ei käytä puskuria yllä olevia lämpötiloja enintään määrätetyillä teknisillä täsmennyksillä. Ylikuumeneminen aiheuttaa korvaamattoman vahingon yksikköön!

Information Importante – French

- Si cet équipement est utilisé dans une manière pas spécifique par Hoefel, Inc. la protection fourni par l'équipement pourrait être diminuée.
- Cet instrument est conçu pour l'usage de laboratoire intérieur seulement.
- Seulement les accessoires et les parties ont approuvé ou ont fourni par Hoefel, Inc. pourrait être utilisé pour fonctionner, maintenir, et entretenir ce produit.
- utilise Seulement une alimentation qui est CET a marqué ou la sécurité certifié par un nationalement reconnu essayant le laboratoire.
- Le couvercle de sécurité doit être à sa place avant connecter l'alimentation mene à une alimentation.
- Tourner tous contrôles d'alimentation de et débrancher les avances de pouvoir avant enlever le couvercle de sécurité.
- Circuler seulement de l'eau ou 50/50 glycol d'eau/éthylène par l'échangeur de chaleur si si équipé. Ne pas connecter l'échangeur de chaleur à un robinet d'eau ou à la source d'agent de refroidissement où la pression d'eau est non régulée.
- Ne Jamais introduire d'antigel ou du dissolvant organique dans n'importe quelle partie de l'instrument. Les dissolvants organiques causeront des dommages irréparables à l'unité!
- Ne pas fonctionner avec les températures de tampon au-dessus du maximum a spécifié des spécifications techniques. La surchauffe causera des dommages irréparables à l'unité !

Wichtige Informationen – German

- Wenn diese Ausrüstung gewissermaßen nicht angegeben durch Hoefel, Inc. verwendet wird, kann der durch die Ausrüstung zur Verfügung gestellte Schutz verschlechtert werden.
- Dieses Instrument wird für den Innenlaborgebrauch nur dafür entworfen.
- Nur Zusätze und Teile genehmigten oder lieferten durch Hoefel, Inc. kann für das Funktionieren, das Aufrechterhalten, und die Wartung dieses Produktes verwendet werden.
- Verwenden Sie nur eine Energieversorgung, die CE gekennzeichnet oder durch ein national anerkanntes Probelaboratorium bescheinigte Sicherheit ist.
- Der Sicherheitsdeckel muss im Platz vor dem Anschließen der Energieversorgung sein führt zu einer Energieversorgung.

- Alle Energieversorgungssteuerungen abdrehen und die Macht trennen führt vor dem Entfernen des Sicherheitsdeckels.
- Nur Wasser oder 50/50 Glykol des Wassers/Äthylens durch den Wärmeaustauscher, wenn so ausgestattet, in Umlauf setzen. Verbinden Sie den Wärmeaustauscher mit einem Wasserklaps oder jeder Kühlmittel-Quelle nicht, wo der Wasserdruck unregelt wird.
- Führen Sie nie Frostschutzmittel oder jedes organische Lösungsmittel in jeden Teil des Instrumentes ein. Organische Lösungsmittel werden nicht wiedergutzumachenden Schaden der Einheit verursachen!
- Mit Puffertemperaturen über angegebenen technischen Spezifizierungen des Maximums nicht funktionieren. Die Überhitzung wird nicht wiedergutzumachenden Schaden der Einheit verursachen!

Informazioni Importanti – Italian

- Se quest'apparecchiatura è usata in un modo specificato da Hoefel, Inc. la protezione fornito dall'apparecchiatura potrebbe essere indebolita.
- Questo strumento è disegnato per l'uso di laboratorio interno solo.
- Solo gli accessori e le parti hanno approvato o hanno fornito da Hoefel, Inc. potrebbe essere usato per operare, per mantenere, e per revisionare questo prodotto.
- usa Solo un alimentatore che è CE ha marcato o la sicurezza certificato da un nazionalmente riconosciuto testando il laboratorio.
- Il coperchio di sicurezza deve essere nel luogo prima di collegare i piombi di alimentatore a un alimentatore.
- Spegne tutto i controlli di alimentatore e disinserisce i piombi di potere prima di togliere il coperchio di sicurezza.
- Circola solo l'acqua o 50/50 glicole di acqua/etilene attraverso lo scambiatore di calore se così equipaggiato. Non collegare lo scambiatore di calore a un rubinetto di acqua o qualunque fonte di refrigerante dove la pressione di acqua è sregolata.
- Non introduce mai l'antigelo o qualunque solvente organico in qualunque parte dello strumento. I solventi organici causeranno il danno irreparabile all'unità!
- Non opera con le temperature di tampone al di sopra del massimo ha specificato le descrizioni tecniche. Il surriscaldamento causerà il danno irreparabile all'unità!

Viktig Informasjon – Norwegian

- Hvis dette utstyret blir brukt i en måte ikke spesifisert ved Hoefel, Inc. beskyttelsen som ha blitt git av utstyret kan bli svekket.
- Dette instrumentet er utformet for innendørs laboratoriumbruk bare.
- Bare tilbehør og deler godkjente eller forsynte ved Hoefel, Inc. kan bli brukt for drive, vedlikeholde, og betjene dette produktet.
- bruker Bare en kraftforsyning som er CE merket eller sikkerhet som ha blitt sertifisert av et som nasjonalt ha blitt anerkjent prøver laboratorium.
- Sikkerheten lokket må være på plass før forbindelse kraftforsyningene blyene til en kraftforsyning.
- Vender all kraftforsyningsstyring av og frakopler kreftene blyene for fjerning sikkerheten lokket.
- Sirkulerer bare vann eller 50/50 vann/ethylene glykol gjennom oppvarmingen veksleren i så fall utstyret. Ikke forbind oppvarmingen veksleren til en vanntapp eller noe kjølemiddelkilde hvor vannet

trykket er unregulated.

- Introduserer Aldri antifreeze eller noe organisk løsemiddel inn i noe del av instrumentet. Organiske løsemidler vil forårsake irreparabel skade på enheten !
- Driver med buffertemperaturer over maksimum ikke spesifiserte teknisk spesifikasjoner. Å overoppheting vil forårsake irreparabel skade på enheten !

Wazne Informacje – Polish

- Jeżeli ten sprzęt jest wykorzystywany w sposób nie określone przez Hoefler, Inc. do ochrony przewidzianej przez urządzenie może zostać obniżony.
- Instrument ten jest przeznaczony do użytku w laboratoriach kryty tylko.
- Tylko akcesoriów i części zatwierdzone lub dostarczone przez Hoefler, Inc. mogą być wykorzystane do eksploatacji, utrzymania i obsługi tego produktu.
- Korzystać jedynie zasilacza że jest noszące oznakowanie CE lub bezpieczeństwa uwierzytelnione przez uznane na poziomie krajowym laboratorium badawcze.
- Bezpieczeństwo lid musi być w miejsce przed podłączeniem zasilania prowadzi do zasilania.
- Zaś wszystkie źródła zasilania urządzenia sterujące off i odłączyć moc prowadzi przed odbiorem bezpieczeństwa lid.
- Krążą tylko wody lub wody 50/50/ethylene glycol wymiennik ciepła poprzez jeśli tak wyposażone. Nie należy połączyć wymiennik ciepła woda z kranu lub jakimkolwiek chłodziwo źródła, jeżeli ciśnienie wody jest nieuregulowanych.
- Nigdy nie wprowadzać rozpuszczalnika organicznego przeciw zamarzaniu lub jakichkolwiek na dowolną część dokumentu. Rozpuszczalniki organiczne spowoduje nieodwracalne szkody dla jednostki!
- Nie działają w buforze temperatury powyżej maksymalnego określone specyfikacje techniczne. Przegrzania spowoduje nieodwracalne szkody dla jednostki!

Informações Importantes – Portuguese

- Se este equipamento é usado numa maneira não especificada por Hoefler, Inc. que a protecção fornecida pelo equipamento pode ser comprometida.
- Este instrumento é projectado para uso de interior de laboratório só.
- Só acessórios e partes aprovaram ou forneceu por Hoefler, Inc. pode ser usada para operar, manter, e servicing este produto.
- Só usa um estoque de poder que é CE marcou ou segurança registrada por um nacionalmente reconhecido testando laboratório.
- A tampa de segurança deve estar em lugar antes de ligar o estoque de poder leva a um estoque de poder.
- Desliga todos controles de estoque de poder e desconecta os chumbos de poder antes de retirar a tampa de segurança.
- Circulam só água ou 50/50 glicol de água/ethylene pelo exchanger de calor se for assim equiparam. Não ligue o exchanger de calor a uma torneira de água nem qualquer fonte de refrigerante onde a pressão de água é não regulado.

- Nunca introduz anticongelante nem qualquer orgânico solvente em qualquer parte do instrumento. Orgânico solvente causará agressão irreparável à unidade!
- Não opera com temperaturas de buffer acima do máximo especificou especificações técnicas. Superaquecer causará agressão irreparável à unidade!

Información Importante – Spanish

- Si este equipo es utilizado en una manera no especificado por Hoefler, Inc. la protección proporcionado por el equipo puede ser dañada.
- Este instrumento es diseñado para el uso interior del laboratorio sólo.
- Sólo accesorios y partes aprobaron o suministraron por Hoefler, Inc. puede ser utilizado para operar, para mantener, y para atender a este producto.
- Sólo utiliza una alimentación que es CE marcó o la seguridad certificada por un nacionalmente reconocido probando el laboratorio.
- La tapa de la seguridad debe estar en el lugar antes de conectar la alimentación lleva a una alimentación.
- Apaga todos controles de alimentación y desconecta los plomos del poder antes de quitar la tapa de la seguridad.
- Circula sólo agua o 50/50 glicol de agua/etileno por el intercambiador de calor si ése es el caso equiparon. No conecte el intercambiador de calor a un toque de la agua ni cualquier fuente del líquido refrigerante donde la presión del agua está libre.
- Nunca introduce anticongelante ni algún solvente orgánico en cualquier parte del instrumento. Los solventes orgánicos causarán daño irreparable a la unidad!
- No opera con temperaturas de búfer encima del máximo específico especificaciones técnicas. Recalentar causará daño irreparable a la unidad!

Viktig Information – Swedish

- om denna utrustning används i ett sätt som inte har specificeras av Hoefler, Inc. skyddet tillhandahöll vid utrustningen kan skadas.
- Detta instrument formges för inomhuslaboratorium användning bara.
- Bara medhjälpare och delar godkände eller levererade vid Hoefler, Inc. kan användas för fungera, underhålla, och servicing denna produkt.
- använder bara en kraft tillgång som är CE markerade eller säkerhet intygade vid en nationellt erkänd testande laboratorium.
- Säkerheten locket måste vara på platsen före koppla kraften tillgången blyen till en kraft tillgång.
- Vänder sig alla kraft tillgång kontroller av och kopplar bort kraften blyen före flytta säkerheten locket.
- Cirkulerar bara vatten eller 50/50 vatten/ethylene glycol genom värmen exchanger i så utrustad fall. Inte kopplar värmen exchanger till en vatten kran eller något kylmedel källa där vattnet trycket är unregulated.
- Inför aldrig kylvätska eller något organiska lösningsmedel in i någon del av instrumentet. Organiskt lösningsmedel ska orsaka irreparable skada till enheten!
- Använd inte med buffert temperaturer över det högsta angivna tekniska specifikationerna. Överhettning skulle orsaka irreparabla skador på enheten!

Waste Electrical And Electronic Equipment (WEEE)

English



This symbol indicates that the waste of electrical and electronic equipment must not be disposed as unsorted municipal waste and must be collected separately. Please contact an authorized representative of the manufacturer for information concerning the decommissioning of your equipment.

French



Ce symbole indique que les déchets relatifs à l'équipement électrique et électronique ne doivent pas être jetés comme les ordures ménagères non-triées et doivent être collectés séparément. Contactez un représentant agréé du fabricant pour obtenir des informations sur la mise au rebut de votre équipement.

German



Dieses Symbol kennzeichnet elektrische und elektronische Geräte, die nicht mit dem gewöhnlichen, unsortierten Hausmüll entsorgt werden dürfen, sondern separat behandelt werden müssen. Bitte nehmen Sie Kontakt mit einem autorisierten Beauftragten des Herstellers auf, um Informationen hinsichtlich der Entsorgung Ihres Gerätes zu erhalten.

Italian



Questo simbolo indica che i rifiuti derivanti da apparecchiature elettriche ed elettroniche non devono essere smaltiti come rifiuti municipali indifferenziati e devono invece essere raccolti separatamente. Per informazioni relative alle modalità di smantellamento delle apparecchiature fuori uso, contattare un rappresentante autorizzato del fabbricante.

Spanish



Este símbolo indica que el equipo eléctrico y electrónico no debe tirarse con los desechos domésticos y debe tratarse por separado. Contacte con el representante local del fabricante para obtener más información sobre la forma de desechar el equipo.

Swedish



Denna symbol anger att elektriska och elektroniska utrustningar inte får avyttras som sorterat hushållsavfall och måste samlas in separat. Var god kontakta en auktoriserad tillverkarrepresentant för information angående avyttring av utrustningen.

Function and Description

The Hoefer® SE900 vertical slab gel electrophoresis unit is intended for the second dimension of 2D electrophoresis. It is designed for gel systems which use a single buffer within the gel tank such as those described by Laemmli. Both buffers used in the anodic and cathodic chambers must be the same. Up to 6 second dimension gel separations can be performed simultaneously.

The first dimension separation of 2-D protein electrophoresis should be performed on Immobilized pH Gradient Gels, referred to as IPG strips in this manual. The Hoefer IEF100 can be used to generate first dimension separations in which the proteins are separated by pI. The focused strips are transferred to the SE900 second-dimension slab gel for size separation.

The SE900 is offered as a self cast gel system. The SE900 glass cassettes are 28 cm wide and 21 cm in length producing gels 25 cm wide × up to 20 cm tall, and 1 mm in thickness. The SE900 will also hold glass plates and gels from other vendors.

The SE900 is the separation tank as a stand alone unit. The SE900-1.0 comprises the separation tank, a multiple gel caster, and six glass cassettes.

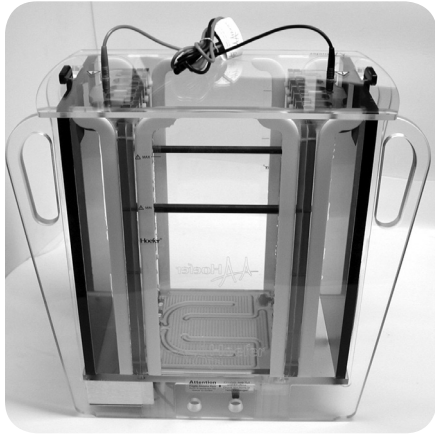

Fig 1. The Hoefer SE900.

Specifications

This declaration of conformity is only valid for the instrument when it is:

- used in laboratory locations,
- used as delivered from Hoefer, Inc. except for alterations described in the user manual, and
- connected to other CE-labeled instruments or products recommended or approved by Hoefer, Inc.

Gel plate size (w × h):	28 × 21 cm	
Gel size:	25 × 20 cm	
Maximum watt:	100 W	
Maximum volt:	600 V	
Maximum ampere:	1000 mA	
Maximum temperature:	45 °C	
Environmental operating conditions:	Indoor use:	4–40 °C
	Humidity:	up to 80%
	Altitude:	up to 2000 m
	Installation category:	II
	Pollution degree:	2
Maximum recirculation water pressure:	12 psi	
Dimensions (w × h × d):	43 × 43 × 20 cm 17 × 17 × 8 inch	
Weight:	22.3 lbs, 10.1 kg	
Input rating:	100–240 V 50–60 Hz 2A	
Product certifications:	EN61010-1:2001, CE	

Unpacking and Inventory

Unwrap all packages carefully and compare the contents with the packing list, making sure all the items have arrived. If any part is missing, contact your local sales office. Inspect all components for damage that may have occurred while the unit was in transit. If any part appears damaged, contact the carrier immediately. Be sure to keep all packing material for damage claims or to use should it become necessary to return the unit.

Fig 2. The SE900. The separation tank, PAGE rack, and safety lid.

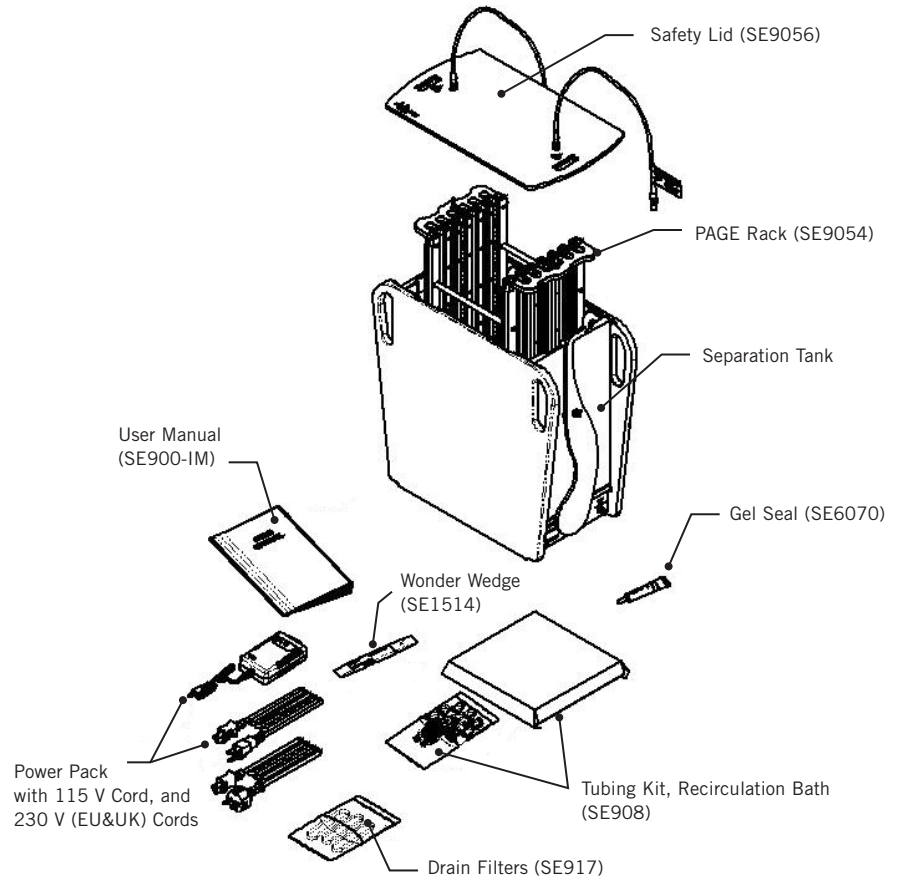

The SE900-1.0. The system including the SE900 above, multiple gel caster, (6) glass cassettes.

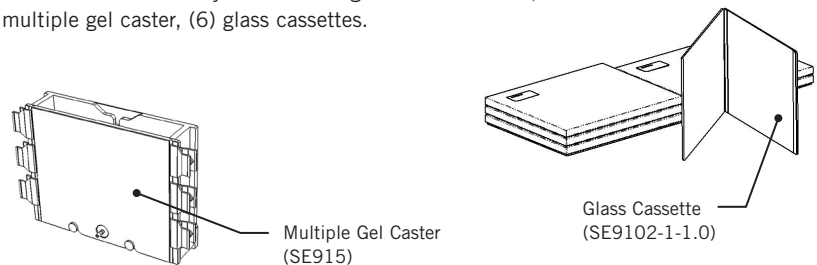



Caution! Never use water/alcohol mixtures or commercial antifreeze as the coolant in the recirculating water bath. This will cause irreparable damage to the separation tank.

Note: The separation tank is chemically resistant to common electrophoretic buffers, but not to organic solvents or strong acids and alkali.

Temperatures above 45 °C may cause acrylic to warp.

Note: There is no need for a magnetic stir bar. The pumps circulate the buffer evenly.

Separation Tank

The Separation tank is transparent to allow visualization of the tracking dyes during electrophoresis.

The chamber base contains a ceramic cooling surface which helps to efficiently cool the buffer within the tank. **Care should be taken not to drop ANYTHING directly on the ceramic plate.** A pump system forces buffer across the cooling surface and circulates the buffer through the center region of the tank, maintaining a constant temperature in the gel cassettes. Cooling ports can be attached to a temperature regulated recirculating water bath for active cooling of the separation tank.

The recirculating water bath should have a maximum output pressure of 12 psi. Use **ONLY** water or up to a 50% mixture of ethylene glycol in water in the recirculating bath.

Never connect to an unregulated source of water such as a tap water.

Fig 3. Separation tank.

Note: A light layer of gel seal has been applied inside the guide channels in the separation tank to allow the PAGE rack to slide into the tank easily. Do not wash off. Reapply as needed, see Instructions page 9, Gel Seal.





Fig 4. Key aligns with a mating feature in the PAGE rack to ensure proper orientation.

Safety Interlocks

Safety interlocks are mounted on the sides of the tank. One is red and the other is black to help with orienting the gels correctly within the gel tank. For safety reasons, the top of the safety interlock secures the lid during electrophoresis, and the bottom prevents access to the drain port. This prevents electrical hazard of draining electrified buffer. A key at the bottom of the separation tank (Fig 4) aligns with a mating feature in the PAGE rack (Fig 6) to ensure proper orientation.

A drain port is included at the bottom behind the black safety interlock. The drain is protected by a removable filter that will block parts of gels from clogging the drain port. This filter should be removed and rinsed off periodically.

PAGE Rack

The rack serves three purposes:

1. It divides the tank into anodic and cathodic chambers and supports and seals the gel cassettes vertically inside the separation tank with rubber gaskets.
2. It holds the platinum wire electrodes that conduct the current during electrophoresis.
3. Features in the base create the circulation pattern to maintain constant temperature, and provide efficient cooling if the SE900 is connected to a recirculating water bath.

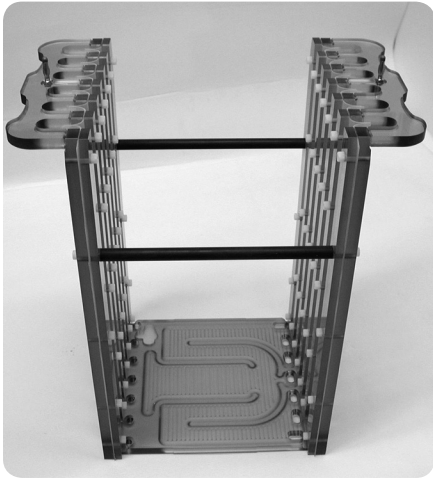

Fig 5. PAGE rack.

The PAGE rack locates in four channels in the clear sides of the tank. The PAGE rack has only one proper orientation. A cutout in the base (Fig 6) aligns with a key in the separation tank. If the PAGE rack is inserted incorrectly, the buffer circulation will not function properly, and the safety lid will not fit.

The electrodes terminate at banana plugs that connect to the safety lid (Fig 7).

Slots with rubber seals accept the gel cassettes and hold them vertically in the separation tank. If one of the six positions is empty, the rubber seals eliminate electrical leaks without the need for blank cassettes or space fillers.

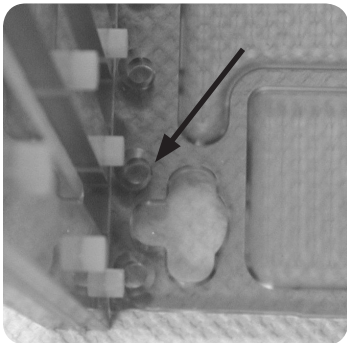

Fig 6. Orientation feature.



Fig 7. Banana plug.



Caution! Always install the safety lid before use!

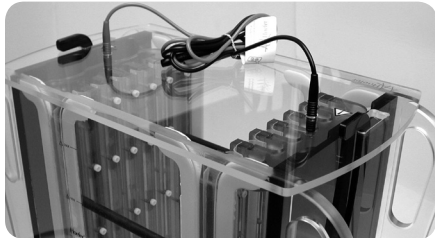

Fig 8. Safety lid.

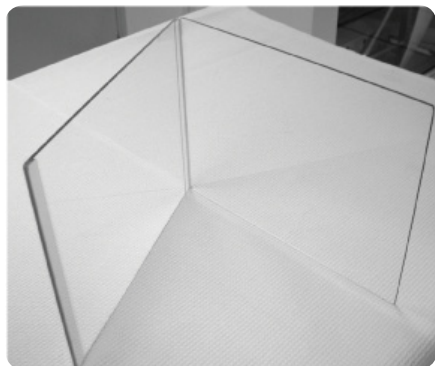

Fig 9. SE9102-1-1.0 glass cassette.

Safety Lid

The safety lid holds the high voltage leads that connect to an external power supply (not supplied). The lid is held in place by the safety interlocks during electrophoresis (Fig 8).

The color-coded high voltage leads have safe 4 mm plugs that interface directly with Hoefer power supplies. Adapters may be required to connect the SE900 to other power supplies. Check the connection before using the SE900.

Glass Cassettes

The glass plates are 28 cm wide × 21 cm in length. The cassettes have 1 mm thick glass spacers glued into place and are hinged for easy assembly (Fig 9). Six glass cassettes are included with each SE900-1.0. Additional cassettes can be ordered separately as SE9102-1-1.0.

It is important that the cassettes be positioned with the hinge side down in the separation tank during electrophoresis.

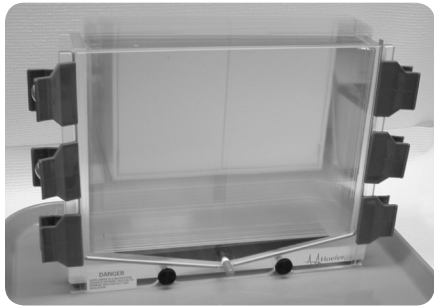

Fig 10. Multiple gel caster.

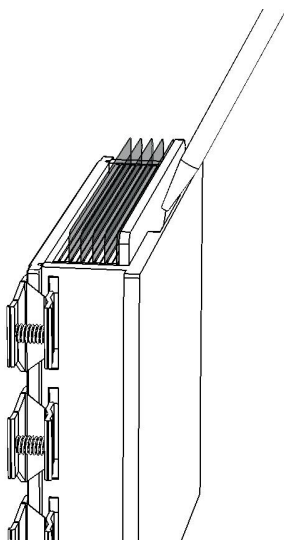

Fig 11. Multicaster filling line.

Multiple Gel Caster

The multiple gel caster is included with the SE900-1.0 (Fig 10), and can be ordered separately as the SE915.

The multiple gel caster is used to cast up to seven 1 mm thick gels at the same time. Separator sheets are placed between glass cassettes before casting to keep the cassettes from sticking to each other after polymerization.

When casting single percentage gels by hand, pour the gel solution down the channel in the back wall of the caster (Fig 11). The cassettes will fill from the bottom producing better quality gels, and reducing the chances of trapping air bubbles.

When casting gradient gels, the gel solution should be slowly pumped in through the port at the bottom. The triangular plug at the bottom should be removed. The triangular region forms a space for the gradient gel to spread out and enter the glass cassettes uniformly.

When using butanol overlays, try to minimize contact of butanol with the plastic multicaster. Prolonged contact with butanol may craze the plastic of the multicaster.

Space Saver

The space saver is used to fill space within the multiple gel caster, and reduce the amount of gel solution. One space saver is equivalent in thickness to one 1.0 mm glass cassette.

When casting six 1.0 mm thick gels, use one space saver at the back of the multiple gel caster.

One space saver is included with the multiple gel caster. Additional space savers (SE912) can be ordered separately if less than 6 gels are routinely cast.

Separator Sheets

The sheets have a protective film on both sides which should be removed before use.

Wonder Wedge

The Wonder Wedge is helpful to pry apart the glass plates after electrophoresis.

Gel Seal

Gel seal is used in the separation tank to lubricate the channels for the PAGE rack, and help it slide into place. If the PAGE rack starts to stick as it is inserted into the tank, apply a thin layer of gel seal to the inside of the four channels with a gloved finger.

Gel seal is also used on the gasket in the multiple gel caster.

Plate Rack

The plate rack (SE914) may be ordered separately. It is very convenient to hold the glass cassettes during assembly of the multiple gel caster, and when applying IPG strips to the top of the second dimension gels.

Fig 12. Plate rack, SE914.

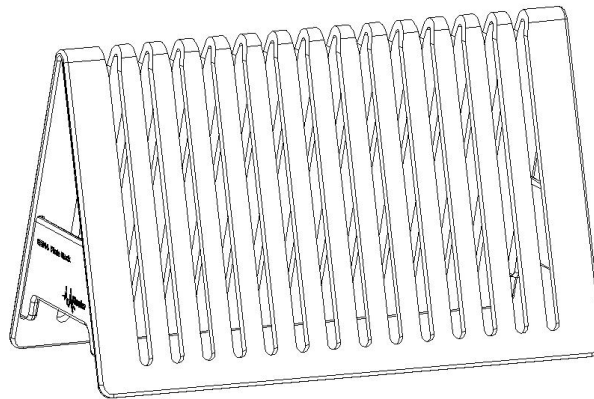

Operating Instructions

Note: Do not remove the layer of gel seal from inside the white channels that position the PAGE rack.

Note: Do not run the pumps dry.

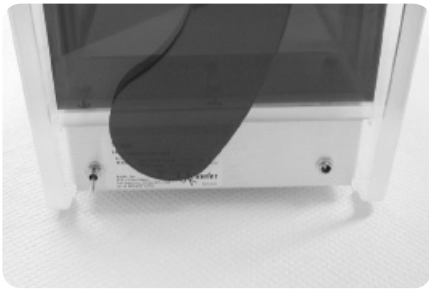

Fig 13. Panel located on lower right side of the SE900. The power supply plugs into the power supply inlet on the right. The ON/OFF toggle switch is on the left.

Separation Tank Setup

- 1 Position the SE900 with the black safety interlock on the left, as shown in Fig 20 on page 17.
- 2 Place the separation tank near a sink for easy buffer draining and disposal.
- 3 Before using for the first time, disassemble the unit and wash with a dilute solution of a laboratory detergent. Rinse thoroughly first with water and then with distilled water.

Glass plates should be washed well and dried completely before casting gels.

- 4 Plug one end of the power pack into the power entry on the lower right side of the SE900. Plug the other end into an appropriate grounded outlet.

The circulating pumps are turned on with a toggle switch on the lower right side of the SE900 (Fig 13).

- 5 Connect the cooling ports to an external recirculating water bath, if active cooling is desired.

Using the Multiple Gel Caster

Note: If desired, labels printed on filter paper can be included in the cassette. Sheets of #1 Whatman filter paper can be used to print gel id numbers, cut into small pieces and positioned in the bottom corners of the cassette. When gel solutions are added the numbers will be polymerized into the gel matrix allowing for easier identification of second dimension gels.



Caution! Glass edges may be sharp so handle glass cassettes with care.

Casting Homogenous Gels

- 1 Make sure the caster and the glass cassettes are clean and dry.
- 2 Close each of the glass cassettes making sure the edges align flush.
- 3 Disassemble the clean multiple gel caster, and lay the back of the caster flat on the bench.
- 4 The two faceplate screws should be loosened, but can remain in place.
- 5 The triangular gasket should be put in place.
- 6 Place the space saver in the back of the caster.
- 7 Place a separator sheet over the space saver.
- 8 Place a glass cassette on top of the first separator sheet.
- 9 Place a separator sheet over the glass cassette.
- 10 Continue to stack alternating glass cassettes and separator sheets for each gel being cast.
- 11 Complete the assembly by adding enough separator sheets to fill the caster just above flush.
- 12 Lightly grease the gasket in the faceplate with gel seal to assure a leak free casting. Replace the gasket in the faceplate without bunching or stretching the gasket.
- 13 Complete the assembly with a separator sheet.
- 14 Slide the faceplate into place under the two screws and tighten the screws.
- 15 Attach the 6 red clamps, 3 per side, along the sides of the caster.
- 16 Make sure the cap is on the bottom port of the caster before pouring gels by hand.
- 17 Stand the assembled caster upright on a level surface.

Fig 14. Multicaster assembly.

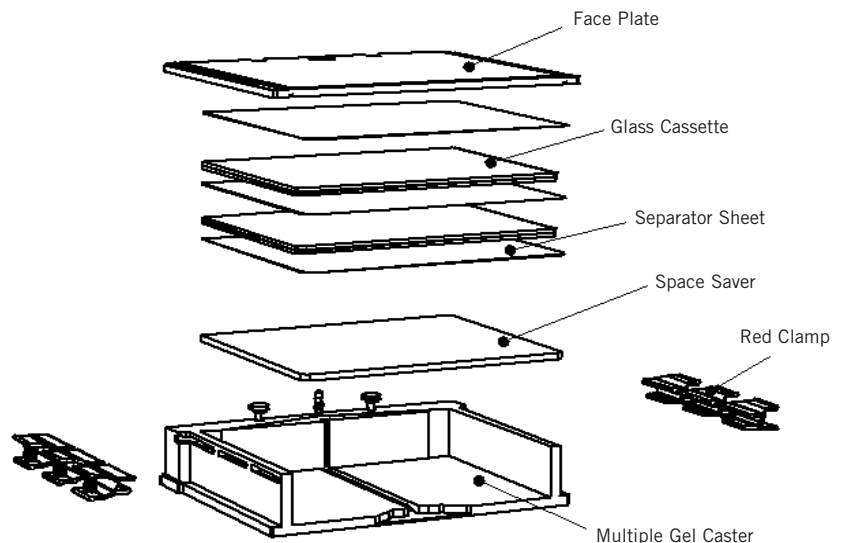



Caution! Acrylamide is a neurotoxin. Extreme care should be used when handling and preparing acrylamide solutions.

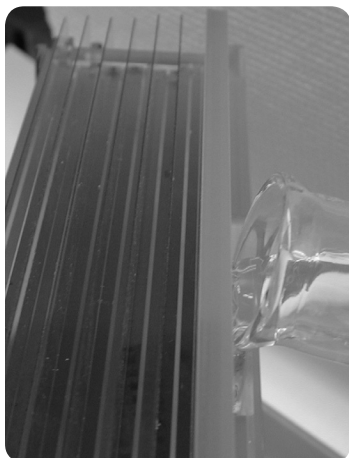

Fig 15. Pour the solution in a slow continuous stream.

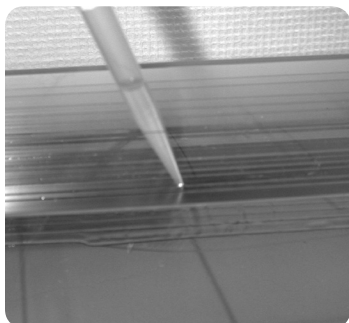

Fig 16. Applying overlay.

Note: A stacking gel can be used if desired, but is not necessary.

Note: It is necessary to remove any butanol overlays before storing the gels in the caster. Leaving butanol in the caster can lead to whitening and brittleness of the acrylic.

Prepare the Acrylamide Solution

- 1 See Appendix A for SDS-PAGE recipes. For casting six SE9102-1-1.0 gels, 400 ml is needed.
- 2 De-aerate the gel solution for 5 minutes. Add the (initiator) 10% w/v APS and the (catalyst) 10% v/v TEMED* just prior to casting the gels. Pour the gel solution into the channel in the back of the caster. The solution will flow down the channel and fill the cassettes from the bottom (Fig 15).

*The TEMED is diluted to 10% for better distribution during mixing of the gel solutions.

- 3 Pour the solution as a slow, continuous stream. Try to minimize the introduction of air bubbles into the flow.
- 4 Fill solution to 0.5–1 cm below the top of the glass plate to allow room for the IPG strip and an agarose seal.
- 5 Overlay each gel with a thin layer of water-saturated *n*-butanol or diluted gel buffer to get the best surface on the top of the gel. *Slowly* apply the overlay near the gel surface from one side, taking care to prevent mixing. Allow the overlay to flow across the surface unaided (Fig 16).
- 6 Allow the gel to polymerize approximately one hour.
- 7 Remove the overlay by rinsing the top of the gel several times with distilled water. Use diluted gel buffer as a final rinse.
- 8 **Optional-storage:** The second dimension gels can be temporarily stored in the caster.

The second dimension gels can also be removed from the caster and stored 1–2 days submerged in gel buffer before use. There is a risk that with prolonged storage, the gels absorb water, and the cassette partially opens, leading to skewed dye fronts.

Gradient Gels

Linear gradient gels can be cast using an optional accessory, the Hoefer SG500 Gradient Maker. The SG500 mixes low percentage and high percentage gel solutions that are pumped into the port at the bottom of the multiple gel caster using a peristaltic pump.

Note: It is a good idea to practice with water and the peristaltic pump to empirically determine the volumes and the flow rates to cast good gradient gels.

Note: Avoid getting air bubbles into the pump tubing, Air bubbles will interfere with proper gradient formation.

Note: The displacement solution is required. The gradient will not form correctly without displacing the acrylamide up inside the cassettes. It also helps keep acrylamide from polymerizing in the tubing and in the bottom of the caster, simplifying clean up. The displacement solution should not enter the bottom of the cassettes.

Pouring a Linear Gradient Gel

- 1 Assemble the multiple gel caster as described on page 11, with the following two exceptions:
 - Do not insert the triangular rubber gasket at the bottom of the gel caster.
 - Remove the cap from the bottom inlet port.
- 2 Attach one end of laboratory grade tubing to the SG500 outlet port. Insert the tubing through a peristaltic pump, and attach the other end to the inlet port of the SE915 multiple gel caster faceplate.
- 3 Calculate the volume of monomer solution needed. Divide the total volume in half and prepare this volume of both the higher- and lower-percentage acrylamide solutions.
- 4 **Optional:** Adjust the higher-percentage acrylamide solution to 15% (w/v) sucrose or up to 25% (v/v) glycerol to improve layering.
- 5 Pour the higher percentage, or heavy, acrylamide solution into the SG500 chamber farthest from the outlet. Open the stopcock just long enough to displace air between the chambers and then close.
- 6 Pour the lower percentage, or lighter, acrylamide solution into the mixing chamber, the chamber with the SG500 outlet.
- 7 Place a stir bar into the mixing chamber. Place the gradient maker onto a magnetic stirrer, and begin stirring at a rate that mixes well but does not introduce bubbles into the solution.
- 8 Turn on the peristaltic pump to a low setting, and open the stopcock between the two SG500 chambers.
- 9 The gel solution should slowly layer in the triangular region at the bottom of the multiple gel caster, and fill the cassettes evenly from the bottom to the top.
- 10 Once almost all solution has exited the gradient maker pause the pump temporarily, and fill the gradient maker with ~200 mls of the displacement solution. Restart the pump and pump the solution through the tubing, forcing the acrylamide solutions up into the gel cassettes until the desired height is reached. Stop the pump.
- 11 Overlay each gel with 1 ml of water-saturated *n*-butanol or diluted gel buffer to get the best top gel surface. Slowly deliver the overlay solution on one side, minimizing mixing, and allow the overlay to flow across the top surface unaided.
- 12 Allow the gels to polymerize for a minimum of one hour. After polymerization, pour off the overlay and rinse the gel surface several times with distilled water.
- 13 Prepare the stacking gel monomer solution. Pour the stacking gel on top of the resolving gel. Allow a minimum of one hour for the stacking gel to polymerize.

Note: The Plate Rack, SE914, is a convenient accessory for temporarily holding the gel cassettes when disassembling the multiple gel caster.

Disassembling the Multiple Gel Caster

- 1 Place the caster down on its back in a tray or sink.
- 2 Remove the red clamps and screws securing the faceplate to the caster.
- 3 Slide off the faceplate.
- 4 Remove gel cassettes and filler sheets. Rinse outside of the gel cassettes to remove excess polymerized acrylamide.
- 5 Clean the multiple gel caster components with laboratory detergent. Rinse and let air dry.

IPG Strip Equilibration

Before IPG strips are placed on top of the second dimension gel, the buffer in the strips needs to be replaced with an appropriate buffer for PAGE.

Equilibrate IPG strips in appropriate equilibration buffers. Typically, a two step equilibration (first with DTT and a second with iodoacetamide) gives better results than a single DTT equilibration step. The following procedure is recommended.

Equilibration Procedure

- 1 Thaw two aliquots of the equilibration solution.
- 2 Add 10 mg/ml DTT to one solution.
- 3 Place the IPG strips in the rehydration/equilibration tray, or a glass tube.
- 4 Add 6.5 ml of solution to each slot containing an IPG strip.
- 5 Place on rocker for 10–15 minutes.

Following equilibration, discard the first equilibration solution in an appropriate manner.

- 6 Add 25 mg/ml iodoacetamide (IAA) to the second aliquot of equilibration solution.
- 7 Add 6.5 ml of solution to each slot containing an IPG strip.
- 8 Place on rocker for 10–15 minutes.

Following equilibration, discard the second equilibration solution in an appropriate manner.

Following equilibration, the IPG strips are placed on the top of the second dimension gel, and sealed into place with the agarose overlay.

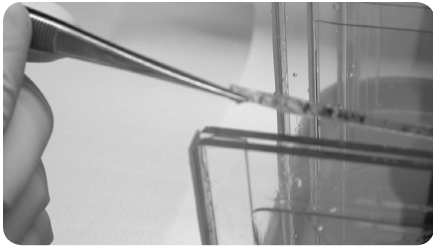

Fig 17. Applying IPG strip to second dimension gel.



Fig 18. Adding agarose overlay.

Sealing the IPG to the Second Dimension Gel

- 1 Remove residual liquid from the top of the second dimension gel by tipping the cassette and blotting one corner with a lint-free tissue.
- 2 Apply the equilibrated IPG strip to the gel surface (Fig 17). A thin plastic strip is useful to gently seat the IPG directly against the top of the second dimension gel. Do not press the strip into the gel or the results may be distorted. Avoid trapping air bubbles between the strip and the second dimension gel.
- 3 Seal the IPG strip in place by applying hot, molten agarose over the IPG strip (Fig 18). See Appendix A for suggested recipe. Avoid introducing air bubbles while applying the overlay.
- 4 Allow the agarose to solidify before placing gels into the separation tank.



Caution! Do not run the circulation pumps without buffer in the separation tank.

Caution! Glass cassettes will not easily slide into a dry tank. Fill with buffer first and use water or buffer to help lubricate the glass cassettes and rubber flaps.

Page Separation

- 1 Remove the safety lid.
- 2 Fill the tank with 12 liters of 1X electrophoresis buffer. This can be prepared in the separation tank by adding 10X stock and water. Gently raise and lower the PAGE rack to aid in mixing in buffer.
- 3 Turn on the circulation pumps. The toggle switch is located on the lower right side of the SE900.
- 4 Fully insert the PAGE rack to the bottom of the separation tank, making sure the keying features are aligned.
- 5 Insert gels into the slots in the PAGE rack. There is one specific orientation for the gel cassettes. The rubber hinge should be on the bottom of the separation tank. The sealed IPG strip should be on the left, the side with the black safety interlock, and the black high voltage lead in the safety lid (Fig 18).
- 6 Check that both ends of the gel are exposed to the buffer. The glass plates should be centered (Fig 19).

Fig 19. Gel orientation.

Good positioning, centered between flaps.

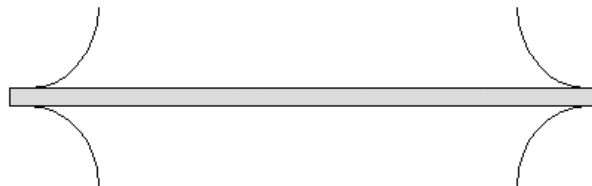

Bad positioning, flap seals closed at end of gel, current cannot get to gel.

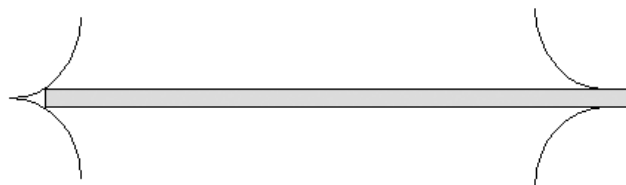

Fig 20. Gel orientation.

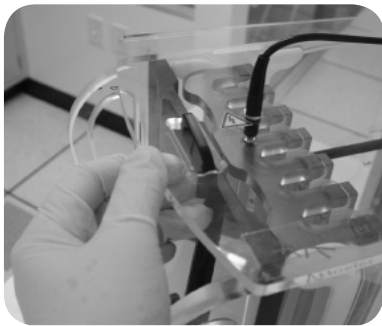
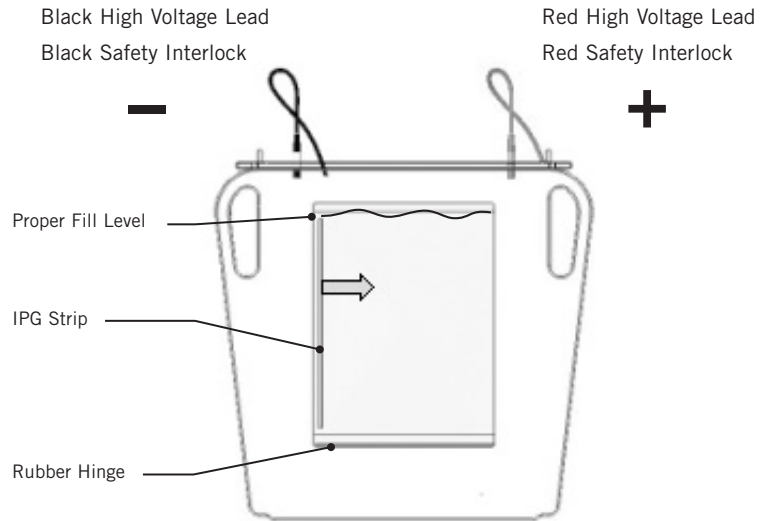

Fig 21. Slide safety lid into place.

Note: The black high voltage lead should be on the same side as the IPG strip.

- 7 After all gels are placed in the tank, check the level of buffer in the separation tank. **The proper level is about halfway up the spacer on the top edge of the gel cassette.** The buffer level also must be below the maximum fill line.
- 8 Attach the safety lid to the separation tank in the proper orientation by moving and fitting the top of the safety interlocks through the slots on the lid, and connecting the high voltage leads to the banana plugs. The safety interlock will secure the lid in place (Fig 21).
- 9 Connect the high voltage leads to a power supply capable of delivering at least 300 V, 500 mA, 90 W, such as the Hoefer PS300-B. Adapters may be needed if using other power supplies.
- 10 Set the power supply to the desired values and start the run.
Note: For day runs set the power supply for 80 mA/gel. When running a full tank of 6 gels set the power supply for 480 mA. Runs should be complete in about 6 hours. The voltage and wattage should be set to their maximums, 600 V and 100 W respectively, so as not to limit the current.
For overnight runs (18 hours), set the power supply for 80 V constant. The current and wattage should be set not to exceed 500 mA and 100 W.
- 11 The run is complete when the tracking dye has reached the opposite side of the gels.
- 12 Turn off the power supply, the circulation pumps, and the external recirculating water bath, if being used.

After Electrophoresis

- 1 Unplug the leads to the power supply.
- 2 Remove the lid by moving the safety interlocks while lifting the lid.
- 3 Carefully lift out each gel. The cassettes are slippery.
Do not use the PAGE rack as a gel carrying rack as the plates may slide out of the rubber gaskets when tipped or moved.
- 4 Place the glass cassette on a clean, flat surface.
- 5 Use the Wonder Wedge to gently open the nonhinged side of the gel cassette.
- 6 Use the Wonder Wedge to gently cut the gel away from the side spacers.
- 7 Carefully remove the gel from the cassette and place in desired staining solutions.
- 8 Attach a length of tubing long enough to reach a sink to the drain connector (Fig 22). Insert the connector into the drain port on the lower left side of the SE900, behind the black safety interlock.
- 9 Allow the tank to drain by gravity. The tank will drain best by having the drain line at least 18 inches (50 cm) below the tank.
- 10 Once drained, re-insert empty PAGE rack. Fill the tank with deionied water, turn on pumps and circulate for 5–10 minutes.
- 11 Turn off pumps and drain again.
- 12 Remove the PAGE rack and allow the components to air dry.
- 13 Remove and rinse any residual acrylamide from the drain filter at the bottom of the separation tank. Replace the drain filter so that it is below flush.

Note: DO NOT use the buffer circulation pumps to help the tank drain faster.

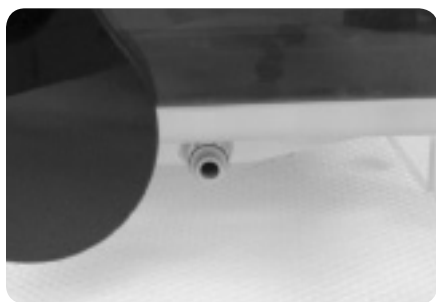

Fig 22. Drain port.

Care and Maintenance

- Handle the PAGE rack with care to prevent damage to the banana plugs and electrode wires.
- Do not drop items onto the ceramic plate at the bottom of the separation tank.
- If necessary, clean the tank with mild detergent and rinse with distilled water. Allow to air dry.
- Clean glass plates and spacers with a dilute solution of a laboratory cleanser such as RBS-35.TM
- Rinse thoroughly with tap and distilled water. Handle the plates with care to prevent chipping and do not pull on or stress the rubber hinge.
- Do not autoclave any components of the system.
- Do not heat any part above 45 °C.
- Do not use organic solvents, abrasives, strong cleaning solutions, or strong acids or bases to clean the chambers.

If the PAGE rack starts to stick as it is inserted into the tank, apply a thin layer of gel seal to the inside of the four channels with a gloved finger.

Technical Service and Repair

Hofer, Inc. offers complete technical support for all of our products. If you have any questions about how to use this product, or would like to arrange to repair it, please call or fax your local Hofer, Inc. representative.

Troubleshooting

Problem	Solution
Casting Issues:	
Gel caster leaks	<p>If the stack is too tall, the front plate may not seat firmly against the gasket. Remove filler plates or cassettes until the gasket seals.</p> <hr/> <p>Apply a light film of gel seal to the foam gasket each time the unit is used.</p> <hr/> <p>Check the foam gasket for cracks or nicks and replace if necessary.</p> <hr/> <p>Caster face plate not properly aligned. Check that the faceplate is evenly positioned on caster.</p>
Poor or Incomplete gel polymerization	<p>Use only recent stock of the highest quality reagents.</p> <hr/> <p>APS reagents or solutions are old and lose their activity when exposed to moisture. Make up fresh APS daily. If the dry ammonium persulfate does not crackle when water is added to it, replace the product with fresh stock. Store reagent tightly closed and in a desiccator to prevent absorption of moisture.</p> <hr/> <p>Remove oxygen from the gel environment. Degas the monomer solution 5 minutes before pouring and then overlay the gel surface with water saturated <i>n</i>-butanol.</p> <hr/> <p>Allow gel solutions to come to room temperature before casting (a minimum of 20 °C, especially for low % T gels).</p> <hr/> <p>Increase both APS and TEMED by 30–50%.</p> <hr/> <p>Solutions with extreme pH values (especially acidic) may not polymerize. Check pH of gel buffers.</p> <hr/> <p>Poor polymerization at the spacers. Make sure to clean the plates well at the spacer edges, that the sides are free of dirt or grease, and that the gel is fully polymerized before removing from the caster.</p>
Gel is too soft, too brittle or white Vertical protein streaks	<p>Adjust crosslinker concentration. Crosslinker should be at 2.6% C for standard SDS gels where $\%C = (g \text{ bis} \times 100) \div (g \text{ monomer} + g \text{ bis})$</p>
Gel contains swirls	<p>Indicates convection currents during polymerization, usually from polymerizing too fast.</p> <hr/> <p>If gel polymerized in <10 min, too much catalyst. Reduce concentration of ammonium persulfate and TEMED by 25%.</p> <hr/> <p>If gel polymerized in >50 min, not enough catalyst. Increase concentration of ammonium persulfate and TEMED by 50%.</p> <hr/> <p>Make sure gel solutions are near room temperature when casting.</p>
Gels cast simultaneously are different sizes	<p>Wait one minute before overlaying each gel so that the solution “settles.”</p> <hr/> <p>Use the same amount of overlay on each separation gel. Add the overlay evenly across the gel surface.</p>

Problem	Solution
Gradient gels-uneven layering	Add sucrose (15% final concentration) or glycerol (25% final concentration) to the high-percent monomer solution.
	Solutions pumped in too fast. Add a small amount of bromophenol blue to the heavy solution to track the gradient formation. Allow for solutions to underlay without excessive mixing.
	Caution! Excessive amounts of bromophenol blue inhibit polymerization.

Electrophoresis Run Problems

Dye front curves up (smiles) at the edges	This indicates current leakage at the spacers. Make sure to clean the plates well at the spacer edges, that the sides are free of dirt or grease, and that the gel is fully polymerized before removing from the caster.
	Gels have been run with hinge side toward the top of the tank. The hinge also seals the lower edge of the gel from electrical leaks. It is best to place cassettes hinge side down to get the straightest dye fronts.
	Inadequate buffer at the top. Make sure the buffer is filled ½ way through the top spacer to make the most even electrical field across the gel and prevent the gel from drying out.
	Too much buffer at the top of the gel. Make sure the buffer is filled ½ way through the top spacer to make the most even electrical field across the gel and prevent the current from bypassing over the gel at the top.
	Check buffer recirculation is on and operating properly.
	Use a refrigerated water bath to maintain even buffer temperature within the tank.
	Decrease the current or voltage setting.
Dye front curves down (frowns) at the edges	Poor polymerization at the spacers. Make sure to clean the plates well at the spacer edges, that the sides are free of dirt or grease, and that the gel is fully polymerized before removing from the caster.
Power Supply detects current leak	Cracked or broken alumina plate in the base of the separation tank. Contact Hoefer or your distributor.
Poor draining of tank	Drain fitting has become clogged with debris. Gently back-flush water through the drain line.
Unusually long run times	Too much buffer at the top of the gel. Make sure the buffer is filled ½ way through the top spacer to make the most even electrical field across the gel and prevent the current from bypassing over the gel at the top.
	Poor reagent quality. Acrylamide solutions can build up acrylic acid over time. Do not keep stock acrylamide solutions longer than ~3 months and store acrylamide at 4 °C.
	Buffer incorrectly prepared. Use the basic form of Tris. Do not adjust the pH of the buffer after preparation.
	Check power settings and adjust if necessary.

Problem	Solution
Instrument Problems:	
No voltage or current at start of the run	Instrument not properly attached to power supply. Make sure high voltage leads are connected into correct +/- terminals and is secure. In some cases adapters may be required.
	Broken electrode. Check continuity of wire with a volt meter.
	Lid not secured properly onto banana plugs. Reposition and check lid is fit securely in place.
	Break in HV lead line. Check continuity of wire with a volt meter.
2D Results Problems:	
Vertical streaking of sample down from the top of the gel towards the bottom of the gel	IPG Strip not properly placed on gel surface. Avoid gouging separating gel while loading strips.
	Perform iodoacetamide treatment.
	Make sure IPG strip uniformly contacts the gel surface along the entire length of the strip.
	Overloading of protein.
Horizontal streaking of proteins	Poor sample preparation.
	Inadequate focusing.
	Poor contact between the IPG strip and the second dimension gel.
Spots are skewed or distorted	Gels run too fast-uneven migration.
	Overlay the resolving gel with water-saturated <i>n</i> -butanol before polymerization begins to avoid forming an uneven gel surface.
	Uneven gel polymerization or gradient formation. See casting problems for more support.
	IPG strip not properly placed on gel surface. Avoid gouging separating gel while loading strips.
	Sample entry into the second dimension gel is run at too high a power setting. Run gels at recommended run conditions.
	Bubbles present in second dimension gel will distort the spot migration.
No proteins visible on second dimension gel after staining	Quantity loaded too little for detection method. Increase protein load or try a more sensitive staining method.
	Too little sample applied to first dimension gel. Check protein concentration of sample.
	Equilibration steps too short or too long. Perform each equilibration step for 10–15 minutes.
Blank regions in the second dimension gel	Tris, salts, and SDS can cause alterations in the focusing position of proteins in the first dimension. Reduce or eliminate these compounds from the first dimension.
	Bubbles between the strip and the second dimension gel.

Ordering Information

Product	Quantity	Order Code
Large Format PAGE	1	SE900
Large Format PAGE Complete	1	SE900-1.0
Tubing Kit for Recirculating Chiller	1	SE908
Multicaster	1	SE915
Space Saver Plate, Multiple Gel Caster	1	SE912
Glass Hinge Cassette 25 × 20, 1 mm	1	SE9102-1-1.0
Plate Rack	1	SE914
Drain Filter	3	SE917
Gel Seal	1	SE6070

Related Products

Isoelectric Focusing Unit	1	IEF100
Recirculating Chiller	1	RCB20
PS300B Power Supply	1	PS300B
Acrylamide	1 kg	GR141-1
Agarose	500 g	GR140-500
Ammonium Persulfate	10 g	GR152-10
Brilliant Blue G	25 g	GR134-25
Brilliant Blue R	25 g	GR135-25
Bromophenol Blue	10 g	GR120-10
Dithiothreitol (DTT)	5 g	GR122-5
Glycerol	1 L	GR124-1
Glycine	1 kg	GR125-1
N,N'-Methylene-bis-Acrylamide	100 g	GR142-100
Sodium Dodecyl Sulfate	500 g	GR126-500
TEMED	25 g	GR151-25
Tris	1 kg	GR132-1
Tris-Glycine-SDS Buffer, 10X	1 L	GR149-1
Urea	1 kg	GR143-1

Appendix A: Theory and Recipes

Laemmli System Gels

The Laemmli system is the most common electrophoresis protocol for SDS-denatured proteins.

The leading ion in this discontinuous buffer system is chloride and the trailing ion is glycine.

Accordingly, the resolving gel (and the optional stacking gel) contain Tris-Cl buffers (of different concentration and pH), and the electrophoresis buffer contains Tris-glycine. All buffers contain 0.1% SDS.

Polyacrylamide gel composition is indicated by two different percentages:

$$\% T = \text{total acrylamide} = \frac{[\text{g (acryl + bis)}]}{100} \times 100$$

$$\% C = \text{crosslinker} = \frac{\text{g (bis)}}{\text{g (acryl + bis)}} \times 100$$

The total percent of acrylamide (% T) in the resolving gel, which can range from 5 to 20%, determines the pore size. Commonly, the amount of crosslinker used (% C) is 2.6%.



Caution! Acrylamide is a neurotoxin. Extreme care should be used when handling and preparing acrylamide solutions.

Solutions

1. Acrylamide Stock Solution

(30.8% T 2.6% C Bis, 1000 ml)

Acrylamide	(FW 71.08)	30% w/v	300 g
Bis*N,N' Methylenebisacrylamide	(FW 154.2)	0.8% w/v	8 g

Deionized H₂O to 1000 ml.
Store at 4 °C away from light.

2. 1.5 M TrisCl, pH 8.8

(4X Resolving gel buffer, 2 liter)

Tris	(FW 121.1)	1.5 M	363.3 g
------	------------	-------	---------

Dissolve into ~1.5 liters deionized H₂O.
4 N HCl (4N hydrochloric acid) to pH 8.8.
Deionized H₂O to 2000 ml.
Store at 4 °C.

3. 10% w/v SDS Solution

(100 ml)

Sodium dodecylsulfate (SDS)	(FW 288.4)	0.35 M	10 g
-----------------------------	------------	--------	------

Deionized H₂O to 100 ml.
Store at room temperature.

4. 10% w/v APS

(Initiator, 1 ml)

Ammonium persulfate (APS)	(FW 228.2)	0.44 mM	5 g
---------------------------	------------	---------	-----

Deionized H₂O to 5 ml.
Prepare just prior to use.
Fresh APS “crackles” when water is added. If yours does not, replace it with fresh stock.

5. 10% v/v TEMED

(Catalyst, 5 ml)

N, N, N', N'-Tetramethylethylenediamine (TEMED)	(FW116.2)	~0.65 M	0.5 ml
---	------------	---------	--------

Deionized H₂O to 5 ml.
Prepare just prior to use.
Store in a dark glass bottle at room temperature away from light.
TEMED is flammable and should be dispensed in a fume hood.

6. 0.375 M Tris-Cl, 0.1% SDS, pH 8.8

(Resolving gel overlay, 100 ml)

1.5 M Tris-Cl, pH 8.8	(Solution #2)	0.375 M	25 ml
10% SDS	(Solution #4)	3.5 mM	1 ml

Deionized H₂O to 100 ml.

Store at room temperature.

— OR —

Water-saturated *n*-butanol

Shake *n*-butanol and deionized H₂O in a separatory funnel. Remove the aqueous (lower) phase. Repeat this procedure several times. Use the upper phase.

Store at room temperature.

7. 10X Electrophoresis Buffer 0.25 M Tris, 1.92 M Glycine, 1.0% SDS

(10X Electrophoresis buffer, 5.0 liters)

Add powders slowly to ~4 liters deionized water while stirring.

Tris	(FW 121.1)	0.25 M	151.2 g
Glycine	(FW 75.07)	1.92 M	720.6 g
SDS	(FW 288.4)	35 mM	50.0 g

Deionized H₂O to 5.0 liters.

The pH of this buffer is approximately 8.3. Do not adjust pH.

Store room temperature for up to 2 months.

8. 1X Electrophoresis Buffer 0.025 M Tris, 0.192 M Glycine, 0.1% SDS

(1X Electrophoresis buffer, 12.0 liters)

10X Electrophoresis Buffer (Solution #7)	1200 ml
Deionized H ₂ O	10.8 l

This can be prepared in the separation tank. Add 10X stock, water then the PAGE rack. Gently raise and lower the PAGE rack to aid in mixing then allow the recirculation system to mix the buffer well before use.



Caution! SDS may cause the solution to boil over so exercise caution when heating and prevent boiling over.

9. 1% Agarose in 1X Electrophoresis Buffer

(100 ml)

In a 500 ml flask add:

Agarose	1 g
10X Electrophoresis Buffer (Solution #8)	10 ml
Deionized H ₂ O	90 ml
Bromophenol Blue	3 mg

Gently swirl to suspend agarose.

Heat at low power in a microwave oven until agarose is fully dissolved.

Divide into ~1.5 ml plastic screw top tubes.

Store in aliquots at 4 °C.

10. Gradient Gel Casting Displacement Solution

(50% Glycerol in 0.375 mM TrisCl 8.8, 0.1% SDS, 200 ml)

Glycerol	100 ml
1.5M TrisCl pH 8.8 (Solution #2)	50 ml
Deionized H ₂ O	50 ml
Bromophenol Blue	3 mg

Mix well.

11. SDS Equilibration Buffer Solution

This solution is used after IEF, and before second dimension PAGE. The IPG strips are immersed in excess solution to raise the pH of the strip buffer so that it is suitable for PAGE, and to coat the proteins in SDS uniformly so that they migrate properly in the second dimension gel.

Prepares 200 ml

(6 M urea, 75 mM Tris-HCl pH 8.8, 29.3% glycerol, 2% SDS, 0.002% bromophenol blue)

	Final Concentration	Amount
Urea (FW 60.06)	6 M	72.1 g
1.5M Tris-HCl, pH 8.8 stock solution	75 mM	10.0 ml
Glycerol (87% w/w)	29.3% (v/v)	69 ml
SDS (FW 288.38)	2% (w/v)	4.0 g
Bromophenol blue	0.002% (w/v)	4 mg
Deionized H ₂ O		to 200 ml

Aliquot into 30 ml aliquots and store frozen at -20 °C or below.

24 cm IPG's require 5 –10 ml per strip per equilibration step. Shorter strips can use proportionately less volume per equilibrations step.

Note: IPG strips should be equilibrated just prior to second dimension PAGE. Do not equilibrate the IPG strips before storing at -20 °C.

Gel Recipes

The Laemmli gel recipes are for 400 ml of a single concentration solution (enough for six 1.0 mm, 25 × 20 cm gels). Tabulated are volumes for relatively large pore gels (10% T range) as well as smaller pore gels (12.5–20% T range). 5% and 7.5% gels are difficult to handle in large format gels but can be blended into gradient gels for better resolution and easier handling. The recipes given here are for guidance when casting gradient gels. Use ½ total required volume each solution when casting gradient gels. Using the solutions given in Appendix A, all gels are crosslinked with 2.6% C.

Laemmli Gel (per 400 ml gel solution)

Resolving Gel Solution

400 ml

	10.0%	12.5%	15.0%	17.5%	20%
Acrylamide Stock (Soln. #1)	133.3	166.7	200.0	233.3	266.7
1.5 M TrisCl, pH 8.8 (Soln. #2)	100.0	100.0	100.0	100.0	100.0
10% SDS (Soln. #3)	4.0	4.0	4.0	4.0	4.0
Deionized H ₂ O	158.0	124.8	91.5	58.3	25.0
10% APS (Soln. #4)	4.0	4.0	4.0	4.0	4.0
10% TEMED (Soln. #5)	0.68	0.55	0.45	0.40	0.34
Final Volume	400.0	400.0	400.0	400.0	400.0

Laemmli Gel (per 200 ml each gel solution)

Gradient Gels Solution

200 ml LIGHT

	5.0%	7.5%	10.0%	12.5%	15.0%	17.5%
Acrylamide Stock (Soln. #1)	33.3	50.0	66.7	83.3	100.0	116.7
1.5 M TrisCl, pH 8.8 (Soln. #2)	50.0	50.0	50.0	50.0	50.0	50.0
10% SDS (Soln. #3)	2.0	2.0	2.0	2.0	2.0	2.0
Deionized H ₂ O	112.2	95.5	79.0	62.4	45.8	29.1
10% APS (Soln. #4)	2.0	2.0	2.0	2.0	2.0	2.0
10% TEMED (Soln. #5)	0.50	0.46	0.34	0.27	0.23	0.20
Final Volume	200.0	200.0	200.0	200.0	200.0	200.0

200 ml HEAVY

	7.5%	10.0%	12.5%	15.0%	17.5%	20%
Acrylamide Stock (Soln. #1)	50.0	66.7	83.3	100.0	116.7	133.3
1.5 M TrisCl, pH 8.8 (Soln. #2)	50.0	50.0	50.0	50.0	50.0	50.0
10% SDS (Soln. #3)	2.0	2.0	2.0	2.0	2.0	2.0
Deionized H ₂ O	83.0	66.5	49.9	33.3	16.6	0.0
10% APS (Soln. #4)	2.0	2.0	2.0	2.0	2.0	2.0
10% TEMED (Soln. #5)	0.46	0.34	0.27	0.23	0.20	0.17
Glycerol	12.50	12.50	12.50	12.50	12.50	12.50
Final Volume	200.0	200.0	200.0	200.0	200.0	200.0

Appendix B: References

Denaturing Gel Systems

Laemmli, U. K. Cleavage of structural proteins during the assembly of the head of bacteriophage T. *Nature*. **227**, 680–685 (1970).

Two-dimensional Electrophoresis

Anderson, Leigh and Anderson, Norman G., High resolution two-dimensional electrophoresis of human plasma proteins. *Proc. Natl. Acad. Sci. USA*. **74**:5421–5425 (1977). Anderson, L. *Two-Dimensional Electrophoresis, Operation of the ISO-DALT® System*, Second Edition. Large Scale Biology Press (1991).

O'Farrell, P. H., High resolution two-dimensional electrophoresis of proteins. *J. Biol. Chem.* May 25; **250**(10):4007–4021 (1975).

Bjellqvist, B., *et al.*, Isoelectric focusing in immobilized pH gradients: principle, methodology and some applications. *J. Biochem. Biophys. Methods* **6**, 317–339 (1982).

Görg, A, *et al.*, The current state of two-dimensional electrophoresis with immobilized pH gradients. *Electrophoresis* **9**, 531–546 (1988).

Görg, A. Two-dimensional electrophoresis with immobilized pH gradients: current state. *Biochem. Soc. Trans.* **21**, 130–132 (1993).

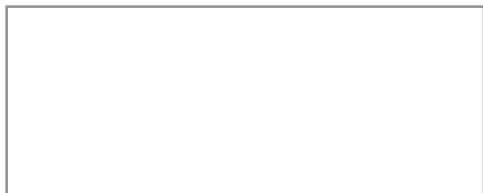

Hoefer, Inc.

84 October Hill Road
Holliston, MA 01746
Toll Free: 1-800-227-4750
Phone: 1-508-893-8999
Fax: 1-508-429-5732

E-mail: support@hoeferinc.com
Web: www.hoeferinc.com

Hoefer is a registered trademark of
Hoefer, Inc.

ISO-DALT is a trademark of Large Scale
Biology Corporation.

© 2012 Hoefer, Inc.—All rights
reserved.

Printed in the USA.

