

SM130

SM1013 EVALUATION KIT
MIFARE® BRIEF TECHNICAL INFORMATION
SMRFID MIFARE® v1.0 SOFTWARE



USER MANUAL

1. INTRODUCTION	4
2. MIFARE® OVERVIEW	5
2.1 MIFARE® BRIEF TECHNICAL INFORMATION	6
2.1.1 MIFARE® MEMORY ORGANIZATION	6
2.2 MIFARE® BLOCKS DESCRIPTION	10
2.2.1 MANUFACTURER BLOCK	10
2.2.2 DATA BLOCKS	10
2.2.3 VALUE BLOCKS	10
2.2.4 SECTOR TRAILER BLOCK	11
2.2.5 LOCK CONFIGURATION PAGE	11
2.2.6 OTP PAGE	11
2.3 ACCESS CONDITIONS FOR SECTOR TRAILER	12
2.4 ACCESS CONDITIONS FOR DATA BLOCKS	13
3. SMRFID MIFARE® SOFTWARE MANUAL	14
3.1 MIFARE® TAG COMMANDS / OPERATIONS	15
3.1.1 SELECT TAG	15
3.1.2 HALT	15
3.1.3 AUTHENTICATION	16
3.1.4 READ	17
3.1.5 WRITE	18
3.1.6 READ VALUE	18
3.1.7 WRITE VALUE	19
3.1.8 INCREMENT VALUE	19
3.1.9 DECREMENT VALUE	19
3.2 HARDWARE COMMANDS / OPERATIONS	20
3.2.1 WRITE E2PROM KEY	20
3.2.2 RF FIELD ON	20
3.2.3 RF FIELD OFF	20
3.2.4 READ PORT	20
3.2.5 WRITE PORT	20
3.2.6 RESET	20
3.2.7 READ FIRMWARE VERSION	20
3.2.8 SLEEP	20
3.2.9 SET BAUD RATE	20
4. SOFTWARE FEATURES	21
4.1 File Menu	21
4.1.1 Open File (Mifare® Format)	21
4.1.2 Save As (Mifare® Format)	21
4.1.3 Import	21
4.1.4 Export	21
4.2 Tools Menu	21
4.2.1 Read All Blocks	21
4.2.2 Write All Blocks	21
4.2.3 Show Data as Text	21

4.3 Special Windows	22
4.3.1 Set Keys	22
4.3.2 Set Lock.....	23
5. SALES AND SERVICE INFORMATION	24

1. INTRODUCTION

SM1013 is a professional evaluation kit for SM130 modules. SM1013 evaluation kit can be used to develop Mifare® applications quickly or it can simply demonstrate main features of the SM130 module. SM1013 can be also used as Mifare® Programmer / Reader.

SM1013 kit comes with:

- 1x Evaluation Board
- 1x SM130 Read/Write module
- 1x PCB antenna
- 1x SMRFID Mifare Software (Downloadable via internet)
- 1x RS232 Serial Cable (Optional)
- 1x 9V DC Adapter (Optional)

Evaluation board comes with on board 5V regulator, RS232 and I2C interface, 2 switches for general purpose inputs and 2 general purpose outputs.

The accompanying software, SMRFID Mifare®, can be used to study the operation of the module easily and quickly and to set configuration parameters of the SM130 module. Read and write ranges up to ~9cm can be achieved with the provided antenna.

SM1013 evaluation kit communicates with PC by RS232 (DB9 jack) serial port (USB-to-Serial adapter works fine) at different baud rates from 9600bps to 115200bps (19200bps default). SM130 module can also communicate with external peripheral on I2C bus. I2C pins are provided with pull-up resistors on the evaluation board.

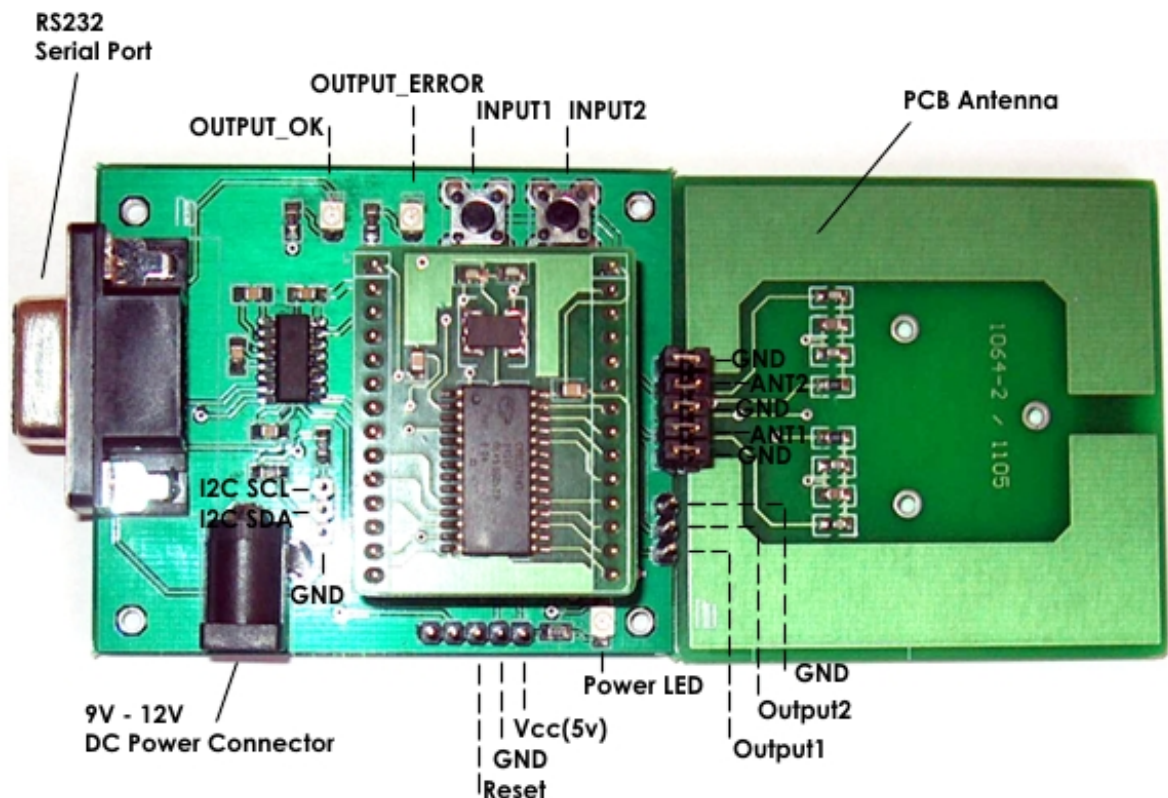

Figure 1 – SM1013 Evaluation Kit Top View

2. MIFARE® OVERVIEW

SM130 Mifare® Read/Write module supports Mifare® Classic 4K, Mifare® Classic 1K and Mifare® Ultralight.

Mifare® Classic is a secure memory (1Kbyte, 4KByte) chip/card often called contactless smart card that is most widely used and selected most successful contactless smart card technology. The reason it is called smartcard is because it has increment and decrement functions designed for especially payment systems. Mifare® Classic family of tags is being used in RFID applications where very high security and fast data collection systems are required. This family of tags has fast contactless communication speed (106 Kbit/s) and uses very strong encryption techniques. It is impossible to copy or modify the content of the Mifare® Classic family of tags without the correct key(s) when it is protected. This high security is approved and tested by VISA and TNO. As a result Mifare® become ideal for e-money applications, secure access, data storage and fast data collection systems. Not only limited with these applications but printed antenna technology makes possible to find very thin and low cost Mifare® tags (e.g. labels, stickers) so that extending the field of RFID applications.

Mifare® Ultralight differs from Mifare® Classic family. It has 512 bits memory and the contactless communication is not encrypted. However it has anti-cloning support by unique 7 byte serial number of each device.

Mifare® is the perfect solution for the applications like loyalty and vending cards , road tolling , city cards access control gaming and much more listed below.

- Public Transport
- Road Toll
- Airline Ticketing
- City Cards
- Banking
- Loyalty
- Health
- Access Control
- Payphone
- Identity
- Government
- Gaming
- Internet
- POS
- Ski Ticketing
- Vending
- Smart Meters (NG, water)

2.1 MIFARE® BRIEF TECHNICAL INFORMATION

For Mifare® tag memory organization and detailed communication principles please refer to following documents of Philips Semiconductor. Mentioned document gives detailed functional specification of the IC used in Mifare® tags.

Document can be downloaded at:

Mifare® 1K (Standard Card IC MF1 IC S50)

<http://www.semiconductors.philips.com/acrobat/other/identification/m001051.pdf>

<http://www.sonmicro.com/1356/d1356.php>

Mifare® 4K (Standard Card IC MF1 IC S70)

<http://www.semiconductors.philips.com/acrobat/other/identification/m043531.pdf>

<http://www.sonmicro.com/1356/d1356.php>

Mifare® Ultralight (Contactless Single-trip Ticket IC MF0 IC U1)

<http://www.semiconductors.philips.com/acrobat/other/identification/m028630.pdf>

<http://www.sonmicro.com/1356/d1356.php>

2.1.1 MIFARE® MEMORY ORGANIZATION

Mifare® 1K and Mifare® 4K have similarities with memory organization but the Mifare Ultralight is slightly different.

Mifare® 1K and Mifare® 4K are arranged of sectors and sectors consist of blocks and blocks consist of 16 bytes. Block 0 of the Sector 0 keeps unique serial number for both Mifare® 1K and Mifare® 4K tags. Sector Trailer block holds access conditions and keys for that particular sector for Mifare® 1K and Mifare® 4K tags. The main difference between the Mifare® 1K and Mifare® 4K is the total sector number and the position of the Sector Trailer block after block 128.

Mifare® 1K has 16 sectors each sector has 4 blocks and each block has 16 bytes. Every Block #3 of the sectors (Sector Trailer) is a special block that holds access conditions and keys for that particular sector.

Mifare® 4K has 40 sectors. [0-39]

From Sector 0 to 31, memory organization is similar to Mifare® 1K. Each sector has 4 blocks and each block has 16 bytes. Every Block #3 of the sectors (Sector Trailer) is a special block that holds access conditions and keys for that particular sector.

From Sector 31 to 39, each sector has 16 blocks and each block has 16 bytes. Every Block #15 of the sector (Sector Trailer) is a special block that holds access conditions and keys for that particular sector.

Mifare® Ultralight consist of 16 pages each page has 4 bytes.

Page0 and Page1 hold unique Serial Number (Read-Only)

Page2 holds lock configuration of pages

Page3 is a special One Time Programmable lock.

Once any bit of Page2 (Lock) and Page3 (OTP) is set to "1" it will never be possible to program that bit as "0".

Mifare® 1K Memory Organization

Sector	Block	Byte Number within Block																Description
		0	1	2	3	4	5	6	7	8	9	A	B	C	D	E	F	
0	0																	Manufacturer Block
	1																	Data Block
	2																	Data Block
	3	Key A					Access Bits				Key B						Sector Trailer 0	
1	0																	Data Block
	1																	Data Block
	2																	Data Block
	3	Key A					Access Bits				Key B						Sector Trailer 1	
...	...																	Data Block
...	...																	Data Block
...	...																	Data Block
...	...	Key A					Access Bits				Key B						Sector Trailer ...	
14	0																	Data Block
	1																	Data Block
	2																	Data Block
	3	Key A					Access Bits				Key B						Sector Trailer 14	
15	0																	Data Block
	1																	Data Block
	2																	Data Block
	3	Key A					Access Bits				Key B						Sector Trailer 15	

Table 1 – Mifare® 1K Memory Organization

Mifare® 4K Memory Organization

Sector	Block	Byte Number within Block																Description
		0	1	2	3	4	5	6	7	8	9	A	B	C	D	E	F	
0	0																	Manufacturer Block
	1																	Data Block
	2																	Data Block
	3	Key A					Access Bits				Key B						Sector Trailer 0	
1	0																	Data Block
	1																	Data Block
	2																	Data Block
	3	Key A					Access Bits				Key B						Sector Trailer 1	
...	...																	Data Block
...	...																	Data Block
...	...																	Data Block
	3	Key A					Access Bits				Key B						Sector Trailer 30	
31	0																	Data Block
	1																	Data Block
	2																	Data Block
	3	Key A					Access Bits				Key B						Sector Trailer 31	
32	0																	Data Block
	1																	Data Block

	15	Key A					Access Bits				Key B						Sector Trailer 32	
33	0																	Data Block
	1																	Data Block

	15	Key A					Access Bits				Key B						Sector Trailer 33	
...
...
...
	15	Key A					Access Bits				Key B						Sector Trailer 38	
39	0																	Data Block
	1																	Data Block

	15	Key A					Access Bits				Key B						Sector Trailer 39	

Table 2 – Mifare® 4K Memory Organization

Mifare® Ultralight Memory Organization

Page	Byte # within Page				Description
	0	1	2	3	
0					Serial Number
1					Serial Number
2					Lock Configuration
3					OTP (One Time Programmable) Area
4					Data Block
5					Data Block
6					Data Block
7					Data Block
8					Data Block
9					Data Block
10					Data Block
11					Data Block
12					Data Block
13					Data Block
14					Data Block
15					Data Block

Table 3 – Mifare® Ultralight Memory Organization

2.2 MIFARE® BLOCKS DESCRIPTION

Mifare® 1K / 4K blocks can be separated into four categories: Manufacturer Block, Data Blocks, Value Blocks and Sector Trailer Blocks.

Mifare® Ultralight slightly differs from Mifare® 1K/4K. Mifare® Ultralight has pages and those pages can be categorized as Manufacturer Block, Lock Configuration Block, OTP Block and Data Blocks.

2.2.1 MANUFACTURER BLOCK

For Mifare® 1K and Mifare® 4K Block 0 of the Sector 0 holds the unique 4 byte serial number of the tag. This read-only block can be accessible without need of any authentication.

For Mifare® Ultralight, Page 0 and Page1 holds the unique 7 byte serial number of the tag. These pages are read-only and can not be modified.

2.2.2 DATA BLOCKS

For Mifare® 1K and Mifare® 4K (Sector 0 to Sector 31); all sectors contain 4 blocks. The first 3 block (Block0, Block1, and Block2) is for general purpose data storage and the last block, Block 3(Sector Trailer), is for access conditions and keys. Sector 0 has an exception that it has only 2 blocks (Block1 and Block2) for general purpose data storage. The first block (Block 0) of the Sector 0 is allocated for manufacturer block and it holds the unique serial number information.

For Mifare® 4K (Sector 32 to Sector 39); all sectors contain 16 blocks. The first 15 block (Block0, Block1..Block14) is for general purpose data storage. 16th block, Block 15(Sector Trailer) is a special block like Block 3 in Mifare® 1K that holds access conditions and keys for that particular sector.

The data blocks can be configured by the access bits present in Sector Trailer block as read/write blocks for general purpose data storage or value blocks for electronic purse application where values are stored in a specific format and increment and decrement operations can be performed on these values.

2.2.3 VALUE BLOCKS

Value blocks are used for electronic purse applications and are stored in a particular format which is defined in Standard Card IC MF1 IC S50/S70 document. This format is useful in error detection and backup management. SM130 module prepares this format automatically and then takes necessary action on the value block of the Mifare® 1K/4K tag.

The Value is a 4byte signed integer. There are two types of operation possible on the value block; increment and decrement. When these commands are executed with a 4 byte increment or decrement value, the value stored in the tag is incremented or decremented with the provided value.

Mifare® Ultralight does not have value blocks.

2.2.4 SECTOR TRAILER BLOCK

In Mifare® 1K tags; the 4th block (Block 3) in each sector,
In Mifare® 4K tags from Sector 0 to Sector 31; the 4th block (Block 3) in each sector
In Mifare® 4K tags from Sector 32 to Sector 39; the 16th (Block 15) in each sector

is called the Sector Trailer.

Mifare® Ultralight does not have Sector Trailer Block.

The sector trailer has access conditions and the secret keys; KeyA and KeyB. KeyA always return 0 when read. KeyB either returns a 0 when read (if used for authentication) or can be used as general purpose storage if not used.

Access bits should present in the sector trailer in proper format. This format is explained in Standard Card IC MF1 IC S50/S70 document. If Sector trailer is written with **improper format** then that sector **won't be accessible again** and no read and write operation on that sector will be possible. SMRFID Mifare® Software will prepare this format automatically and warn the user if necessary. However **care must be taken** to make sure the proper format is used when writing to sector trailer thru external device.

It is also important user should note down the passwords/keys used for the sectors otherwise it is impossible to reset the tag or access it again without knowing the correct key(s).

For the Mifare® tags coming from the factory KeyA is used to access to all blocks with 6 byte hexadecimal key FF FF FF FF FF FF

2.2.5 LOCK CONFIGURATION PAGE

Mifare® Ultralight tags have a special page (Page 2) that sets the read-only configuration of the pages. This page can simply lock the pages so they can not be modified again. Once a block is locked then it will never be possible to modify that block and configuration will remain permanent. In other words, if any "bit" in the lock configuration page is set to "1" then it will never be possible to write "0" to that bit again. Making a bit "1" in the lock configuration page is an irreversibly, permanent operation.

Care must be taken when programming this page. SMRFID Mifare® software will check the bits and warn the user if necessary.

Mifare® 1K/4K does not have lock configuration page and more complicated configuration can be set in Sector Trailer block for these tags.

For furthermore details on this page please investigate Mifare® Ultralight (Contactless Single-trip Ticket IC MF0 IC U1) document.

2.2.6 OTP PAGE

Mifare® Ultralight tags have a special page (Page 3) called OTP, One Time Programmable area. If any bit in this page is set to "1" then it will never be possible to write "0" to this bit. Making a bit "1" in this page is an irreversibly, permanent operation.

Mifare® 1K/4K does not have any OTP page.

For furthermore details on this page please investigate Mifare® Ultralight (Contactless Single-trip Ticket IC MF0 IC U1) document.

2.3 ACCESS CONDITIONS FOR SECTOR TRAILER

The access condition of each block is configured by 3 bits which is stored with proper format in the sector trailer block. For detail of this format see Standard Card IC MF1 IC S50/S70 document. SMRFID Mifare® Software will automatically prepare the proper format according to selected conditions.

The following table (Table 4) lists the various access conditions for the sector trailer itself. There are access conditions for Read/Write for KeyA, KeyB and the Access bits. In the conditions which are marked as grey color in the table, KeyB also may be read. If KeyB may be read with KeyA then read attempt to data block with KeyB will fail because KeyB is readable. Note that KeyA can never be read under any condition. It can only be written/re-programmed provided that with correct key value.

Also, while setting the access conditions, if a condition where the Write is disabled ('Never' is selected) for the access bits, then the access conditions can never be modified after that. This is also valid for Keys.

Access Bits			Access Conditions for Sector Trailer						Description
			Key A		Access Bits		Key B		
C1	C2	C3	Read	Write	Read	Write	Read	Write	
0	0	0	Never	Key A	Key A	Never	Key A	Key A	Key B may be read
0	1	0	Never	Never	Key A	Never	Key A	Never	Key B may be read
1	0	0	Never	Key B	Key A/B	Never	Never	Key B	
1	1	0	Never	Never	Key A/B	Never	Never	Never	
0	0	1	Never	Key A	Key A	Key A	Key A	Key A	Key B may be read
0	1	1	Never	Key B	Key A/B	Never	Key B	Never	
1	0	1	Never	Never	Key A/B	Key B	Never	Never	
1	1	1	Never	Never	Key A/B	Never	Never	Never	

Table 4 – Access Conditions for Sector Trailer Block

For Mifare® 1K/4K tags coming from the factory, 0 0 1 column is used for access conditions where it defines KeyA as an absolute key for all read/write access operations.

Mifare® Ultralight does not have Sector trailer block and does not have special access conditions for the pages

2.4 ACCESS CONDITIONS FOR DATA BLOCKS

Following table (Table – 5) lists the access condition for the data blocks in the sector. Access condition may be set for Read, Write, Increment, Decrement, Transfer and Restore operations.

Note that if any of the access condition uses KeyB for Authentication (Key A/B or Key B), then the access condition for the sector trailer should not have Key B readable (Grey colored rows in Table-4). If in case, the card will refuse operations with this key.

Access Bits			Access Condition for Data Blocks				Application
C1	C2	C3	Read	Write	Increment	Decrement, Transfer, Restore	
0	0	0	Key A/B	Key A/B	Key A/B	Key A/B	Transport Configuration
0	1	0	Key A/B	Never	Never	Never	Read / Write Block
1	0	0	Key A/B	Key B	Never	Never	Read / Write Block
1	1	0	Key A/B	Key B	Key B	Key A/B	Value Block
0	0	1	Key A/B	Never	Never	Key A/B	Value Block
0	1	1	Key B	Key B	Never	Never	Read / Write Block
1	0	1	Key B	Never	Never	Never	Read / Write Block
1	1	1	Never	Never	Never	Never	Read / Write Block

Table 5 – Access Conditions for Sector Trailer Block

SMRFID Mifare® Software can assist you to define keys and access conditions for each sector with proper formats.

Mifare® Ultralight does not have Sector trailer block and does not have special access conditions for the pages

3. SMRFID MIFARE® SOFTWARE MANUAL

SMRFID Mifare® Software is designed to control the module easily and to demonstrate the SM130 capabilities quickly by verifying all operations with the SM1013 Evaluation Kit. Latest version of the software can be downloaded at:

<http://www.sonmicro.com/design1356/downloads.php>

SMRFID Mifare® Software requires a windows OS platform, SM1013 Evaluation Kit and a serial port connection. By connecting the SM1013 kit to the COM port of the PC and running the software, operations like Select Tag, Authenticate, Read, Write, Read Value, Write Value, Increment Value, Decrement Value, Read Input Ports, Set Output Ports, Switching On/Off RF field, Set Baud Rate, Write E2PROM Keys etc. can be performed. Program has also TX/RX activity window that display the data being sent and received over the serial port.

Same template of Mifare® Memory organization is placed into the grid to ease the accessing all blocks of the Mifare® tags visually. Software does not only aim a demonstration environment but also designed for general usage as Mifare® Reader and Programmer. Mifare® data can be exported to text files or imported from text files as well as can be stored as hex files.

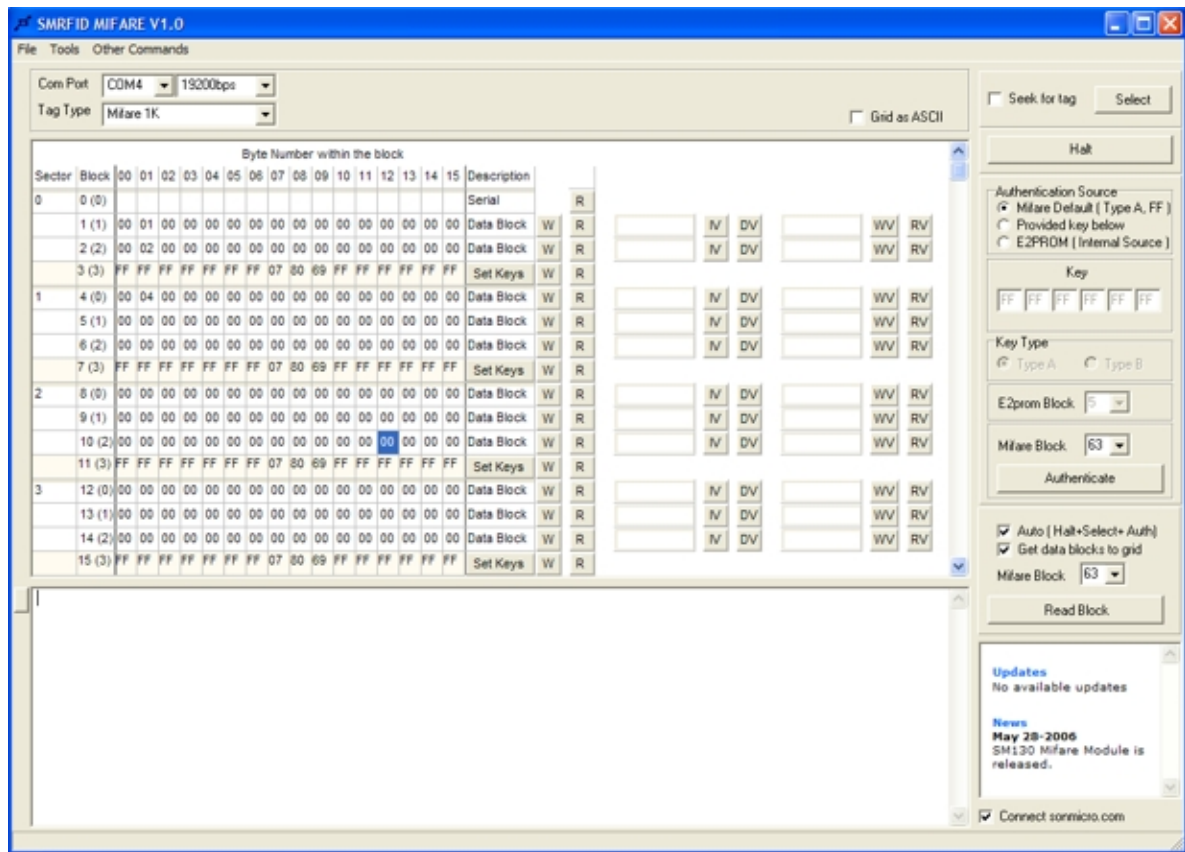

Figure 2 – SMRFID Mifare® Software Snapshot

3.1 MIFARE® TAG COMMANDS / OPERATIONS

Before performing any read/write/increment value/decrement value/read value/write value operation on a Mifare® Tag, tag should be selected and then authenticated. If the same block or, another block in the same sector, had authenticated previously then there is no need to authenticate the block that in the same sector.

3.1.1 SELECT TAG

Before performing any read/write/value operations on a Mifare® Tag, tag should be selected first. For Mifare® 1K and Mifare® 4K tags, authentication process should follow the select operation.

Select operation can be done in two ways. If “Seek for Tag” is not selected then Select operation will return the result immediately. If there is a tag in the field the details of the tag are displayed with the serial number. If “Seek for Tag” is selected then Select operation will return the result whenever a tag enters into the RF field.

Once a tag is selected and still in the RF field, performing sequential select tag operation will result in failure.

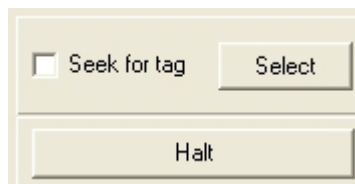

Figure 3 – Select and Halt buttons

3.1.2 HALT

Halt operation is used to halt the Mifare® tag so that tag returns to idle state and operations sequence can start from the beginning by selecting the card first.

3.1.3 AUTHENTICATION

For Mifare® 1K and Mifare® 4K authentication has to be performed after a select operation. Mifare® Ultralight does not use authentication process.

SM130 module can perform authentication using default keys, using the provided keys or using a key stored in its internal EEPROM memory.

The image shows a software interface for authentication. It has several sections:

- Authentication Source:** Three radio buttons. 'Provided key below' is selected.
- Key:** A row of six small boxes, each containing the hexadecimal value 'FF'.
- Key Type:** Two radio buttons. 'Type A' is selected.
- E2prom Block:** A dropdown menu showing the value '0'.
- Mifare Block:** A dropdown menu showing the value '1'.
- Authenticate:** A button at the bottom of the form.

Figure 4 – Authentication

If Mifare Default is selected as authentication source then hexadecimal 6 bytes of, FF FF FF FF FF FF will be used as KeyA (Type A). Mifare® tags uses KeyA, FF FF FF FF FF FF key as default to authenticate when coming from the factory.

If “Provided key below” is selected as authentication source then 6 bytes key should be entered into small boxes and Type of the key should be selected (KeyA or KeyB)

If “E2PROM (Internal Source)” is selected then the type of the Key and the E2prom block where keys are stored should be selected. It is expected that user had stored keys in the selected block of E2prom of SM130 previously at Other Commands > Write E2prom Key window.

Once the authentication source and the keys are determined the Mifare® 1K/4K block number that is to be authenticated should be selected. Authentication is done in block basis but if the other blocks in the same sector have the same access conditions then there is no need to authenticate the other block in the same sector before performing general read/write operations on it.

3.1.4 READ

This command reads a 16 byte block from the Mifare® tag. To read from a particular block in the Mifare® 1K/4K tag, first the tag should be selected and the block should be authenticated. The read will be successful only if the block has permission to read and if the authentication is done with the proper key and key type. If the block is read protected, then the read will fail and the tag will halt.

For the Mifare® 1K/4K Read operation can be done with “Read Block” Button or the “R” buttons in the grid (Should be double clicked).

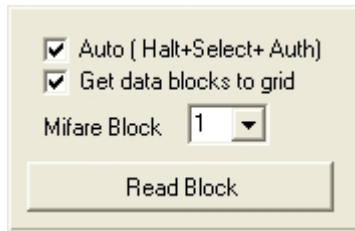

Figure 5 – Read with Button

1	4 (0)	00 00 00 00 00 00 00 00 00 00 00 00 00 00 00 00	Data Block	W	R
	5 (1)	00 00 00 00 00 00 00 00 00 00 00 00 00 00 00 00	Data Block	W	R
	6 (2)	00 00 00 00 00 00 00 00 00 00 00 00 00 00 00 00	Data Block	W	R
	7 (3)	FF FF FF FF FF FF FF 07 80 69 FF FF FF FF FF FF	Set Keys	W	R

Figure 6 – Read from Grid – (Should be double clicked)

If “Auto” is checked then, before any read/write/value operation tag will be halted and selected and authenticated according to the last settings and read command will be executed.

If “Get data blocks to grid” is selected then the read value will be transferred to the grid.

For the Mifare® Ultralight “Read” buttons (Should be double clicked) in the grid can be used to read from the specific page. Mifare® Ultralight does not need authentication process but the select operation is still essential.

Page	Byte Number				Description		
	00	01	02	03		Read	Write
0					Serial	Read	
1					Serial	Read	
2			00 00		Set Lock	Read	Write
3	00 00	00 00			OTP	Read	Write
4	00 00	00 00			Data Block	Read	Write
5	00 00	00 00			Data Block	Read	Write

Figure 7 – Read from Grid – (Should be double clicked)

3.1.5 WRITE

This command writes a 16 byte block to the Mifare® tag. To write to a particular block in the Mifare® 1K/4K tag, first the tag should be selected and the block should be authenticated. The write will be successful only if the block has permission to write and if the authentication is done with the proper key and key type. If the block is write protected then the write will fail and the tag will halt.

For the Mifare® 1K/4K Write operation can be done with “W” buttons in the grid (Should be double clicked).The 16 bytes for the relevant block in the grid will be written to the tag.

1	4 (0)	00 00 00 00 00 00 00 00 00 00 00 00 00 00 00 00	Data Block	W	R
	5 (1)	00 00 00 00 00 00 00 00 00 00 00 00 00 00 00 00	Data Block	W	R
	6 (2)	00 00 00 00 00 00 00 00 00 00 00 00 00 00 00 00	Data Block	W	R
	7 (3)	FF FF FF FF FF FF FF 07 80 69 FF FF FF FF FF FF	Set Keys	W	R

Figure 8 – Write to Mifare® 1K/4K- (Should be double clicked)

A special care should be taken before writing to Sector Trailer block otherwise sector can be irreversibly inaccessible.

If “Auto” is checked then, before any read/write/increment/decrement operation tag will be halted and selected and authenticated according to the last settings and write command will be executed.

For the Mifare® Ultralight “Read” buttons (Should be double clicked) in the grid can be used to make a read.

2		00 00	Set Lock	Read	Write
3		00 00 00 00	OTP	Read	Write
4		00 00 00 00	Data Block	Read	Write

Figure 9 – Write to Mifare® Ultralight – (Should be double clicked)

3.1.6 READ VALUE

This command reads from a value block of Mifare® 1K/4K tag. First tag should be selected and the block should be authenticated. For read value to be successful, the block should have read permission and also should be in the valid value block format. If the block is not in the valid value block format then the tag won't halt.

For the Mifare® 1K/4K Read Value operation can be done with “RV” buttons in the grid (Should be double clicked). The read value will be transferred to the grid if “Get data blocks to grid” is checked. Mifare® Ultralight does not support Read Value operation.

1	4 (0)	00 04 00 00 00 00 00 00 00 00 00 00 00 00 00 00	Data Block	W	R		IV	DV		WV	RV
	5 (1)	00 00 00 00 00 00 00 00 00 00 00 00 00 00 00 00	Data Block	W	R		IV	DV		WV	RV
	6 (2)	00 00 00 00 00 00 00 00 00 00 00 00 00 00 00 00	Data Block	W	R		IV	DV		WV	RV

Figure 10 – Read Value – (Should be double clicked)

3.1.7 WRITE VALUE

This command sends value information to SM130 module. SM130 module prepare valid format for the value block and then writes to the Mifare® 1K/4K tag. First tag should be selected and the block should be authenticated. For write value to be successful, the block should have write permission and also should be written in the valid value block format (SM130 handles it). Value is a 4 Byte signed integer and the range is -2147483648 to 2147483647.

For the Mifare® 1K/4K Read Value operation can be done with “WV” buttons in the grid (Should be double clicked). Value to be written should be typed in hex format to the box near the “WV” button. Mifare® Ultralight does not support Write Value operation.

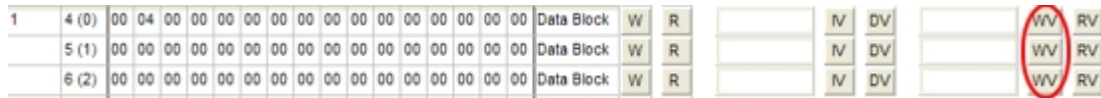

Figure 11 – Write Value – (Should be double clicked)

3.1.8 INCREMENT VALUE

This command increments a value block of Mifare® 1K/4K with a provided value. First tag should be selected and the block should be authenticated. For increment value to be successful, the block should have write permission and also should be in the valid value block format. Increment amount of value is a 4 Byte signed integer and the range is -2147483648 to 2147483647.

For the Mifare® 1K/4K Increment Value operation can be done with “IV” buttons in the grid (Should be double clicked). Increment amount of value should be typed in hex format to the box near the “IV” button. Mifare® Ultralight does not support Increment Value operation.

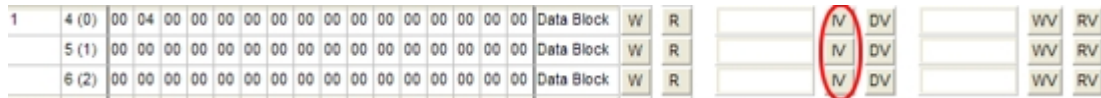

Figure 12 – Increment Value – (Should be double clicked)

3.1.9 DECREMENT VALUE

This command decrements a value block of Mifare® 1K/4K with a provided value. First tag should be selected and the block should be authenticated. For decrement value to be successful, the block should have write permission and also should be in the valid value block format. Decrement amount of value is a 4 Byte signed integer and the range is -2147483648 to 2147483647.

For the Mifare® 1K/4K Decrement Value operation can be done with “DV” buttons in the grid (Should be double clicked). Decrement amount of value should be typed in hex format to the box near left hand side of the “IV” button. Mifare® Ultralight does not support Decrement Value operation.

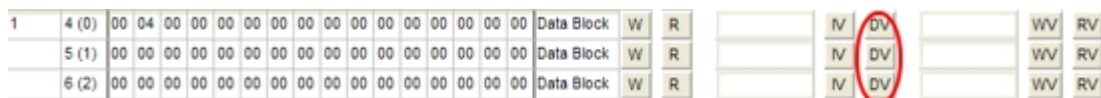

Figure 13 – Decrement Value – (Should be double clicked)

3.2 HARDWARE COMMANDS / OPERATIONS

Apart from the regular Mifare tag operations, the module also has some hardware commands that affect the SM130 module. Hardware commands can be accessible in SMRFID toolbar Hardware Commands>

3.2.1 WRITE E2PROM KEY

There are 16 sectors in the SM130 E2prom memory to store keys. Each sector can hold one TypeA (KeyA) and one TypeB (KeyB) keys. By this way, keys for authentication can be selected from the E2prom memory of SM130 and keys are also prevented to being visible on I2C or UART communication channel.

3.2.2 RF FIELD ON

This commands switches on the RF Field of the SM130 module. This can be used to switch On the RF field only when a read or write operation is performed.

3.2.3 RF FIELD OFF

This commands switches off the RF Field of the SM130 module. This can be used to save power when the module in not reading or writing.

3.2.4 READ PORT

This command is used to read from the 2 general purpose inputs(INPUT1 and INPUT2).Inputs are connected to a push-button in SM1013 kit.

3.2.5 WRITE PORT

This command is used to write to the 2 general purpose outputs (OUTPUT1 and OUTPUT2).OUTPUT pins are included in SM1013 kit near the antenna jumpers

3.2.6 RESET

This command resets the SM130 module.

3.2.7 READ FIRMWARE VERSION

This command is used to request firmware version number of the SM130 module.

3.2.8 SLEEP

This command puts SM130 module into sleep mode. A hardware reset is essential to wake-up the SM130 module.

3.2.9 SET BAUD RATE

This command set UART baud rate of SM130 module. When baud rate is changed module will communicate with new baud rate even after reset until it is changed again by this command.

4. SOFTWARE FEATURES

SMRFID Mifare® software has some features that ease some operations and also makes the software proper for general usage.

4.1 File Menu

Mifare® data can be stored in files as hex or text format for later access. Following features can be accessed under File menu in SMRFID Mifare® software.

4.1.1 Open File (Mifare® Format)

This function opens files that is arranged in special Mifare® format (“.mfr” files) “.mfr” files can only be created by Save File operation and contains Mifare® data in hex format including Sector Trailer data.

Opened file is transferred to the grid and the Mifare® type is automatically selected. Operations on the grid will not be saved until the “Save As” is executed.

4.1.2 Save As (Mifare® Format)

This function saves all data in the grid including Sector Trailer blocks with a special format (“.mfr”).

4.1.3 Import

This function import data from a text file. Only data blocks are updated and Sector Trailer blocks will remain as is. Text file is transferred to the grid from the beginning to the end of the Mifare® tag capacity.

4.1.4 Export

This function exports data in the grid to a text file. Only data blocks are transferred to text file and Sector Trailer blocks information does not exported.

4.2 Tools Menu

Under this menu useful tools can be found. Mifare® tag can be read or written at one time with one click and data can be viewed in text format.

4.2.1 Read All Blocks

This function read all the content of the Mifare® tag.

4.2.2 Write All Blocks

This function writes all grid content to Mifare® tag

4.2.3 Show Data as Text

This function transfer data blocks in the grid as ASCII to the text area. It is useful to read the tag content if it is programmed with ASCII characters.

4.3 Special Windows

There are special windows designed to set keys for Mifare® 1K/4K and lock configuration of Mifare® Ultralight easily and without taking risk to accidentally make the tag or blocks/pages useless.

4.3.1 Set Keys

Sector Trailer block of Mifare® 1K/4K requires a special care. If it is written in a wrong format or if any of the blocks will not be accessible then there will be a warning message to prevent accidental writings. Moreover because of the complexity of the Sector Trailer block a window is designed to set configuration easily. This window can be opened by double clicking on “Set Keys” button in the grid.

1	4 (0)	00	00	00	00	00	00	00	00	00	00	00	00	00	00	00	00	Data Block	W	R
	5 (1)	00	00	00	00	00	00	00	00	00	00	00	00	00	00	00	00	Data Block	W	R
	6 (2)	00	00	00	00	00	00	00	00	00	00	00	00	00	00	00	00	Data Block	W	R
	7 (3)	FF	FF	FF	FF	FF	FF	07	80	69	FF	FF	FF	FF	FF	FF	Set Keys	W	R	

Figure 14 – Set Keys – (Should be double clicked)

When “Set Keys” is double clicked the “Access Conditions for sector blocks” window will be opened. In this window access conditions and keys can be set and applied to the specific sector or all sectors. Descriptions about the selected option can be found under the grid. Note that for sectors including 4 block (Mifare® 1K and Mifare® 4K ,Sector0 to Sector31) data blocks are identified one by one. However for the sectors having 16 blocks(Mifare® 4K , Sector32 to Sector39) data blocks will be identified five by one that is Block0-1-2-3-4 , Block5-6-7-8-9 , Block10-11-12-13-14 , Block15(Sector Trailer).

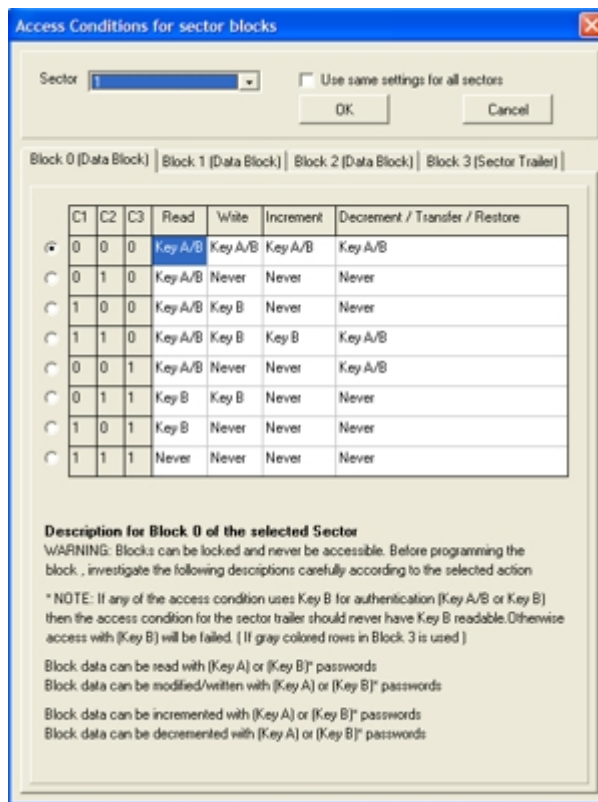

Figure 15 – Access Conditions Window

4.3.2 Set Lock

Lock page of Mifare® Ultralight requires a special care. If a page is locked then that page will be a read-only page permanently and it will never be possible to write that page again. SMRFID Mifare® software will warn the user if any page is locked before writing to prevent an accidental write. Moreover a window is designed to set lock configuration easily. This window can be opened by double clicking on “Set Lock” button

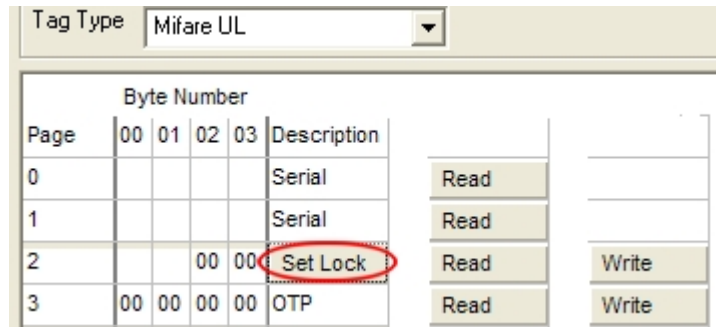

Figure 16 – Set Lock – (Should be double clicked)

When “Set Lock” button is double clicked a configuration window will be opened. In this window lock page data can be generated according to selected options.

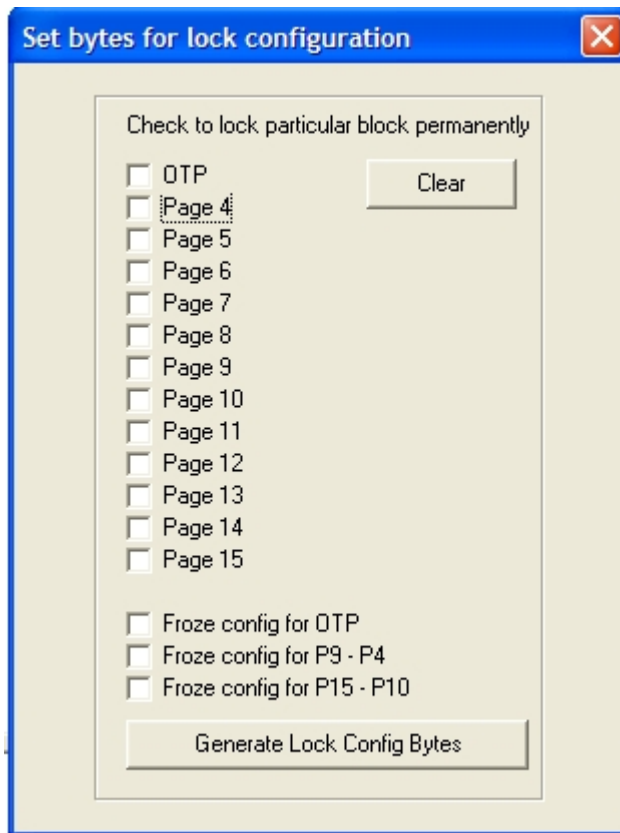

Figure 17 –Lock Configuration Window

5. SALES AND SERVICE INFORMATION

To obtain information about SONMicro Electronics products and technical support, reference the following information.



SONMicro ELECTRONICS LTD.
Cankaya M. Soguksu C.
Aslihan Ishani 2/15
Mersin, 33070
TURKIYE

Phone: +90 324 237 21 28
Facsimile: +90 324 237 21 86
Email: info@sonmicro.com
Web Site: <http://www.sonmicro.com>

Sales	http://www.sonmicro.com/sales.php
Support	http://www.sonmicro.com/ask.php
Documents & Software	http://www.sonmicro.com/1356/d1356.php
User Forums	http://www.sonmicro.com/forums/