



**GAZEBO  
PENGUIN INC.**

4660 Hickmore, St-Laurent  
Quebec, Canada H4T 1K2

1-800-737-7174 / 514-276-3485

Fax : 1-514-276-4147

gazebopenguin@gmail.com

**PLEASE, READ  
BEFORE  
INSTALLATION**

**PLEASE, READ  
BEFORE  
INSTALLATION**

**41218**

**12 X 18 SOLARIUM**

**ASSEMBLY INSTRUCTIONS**

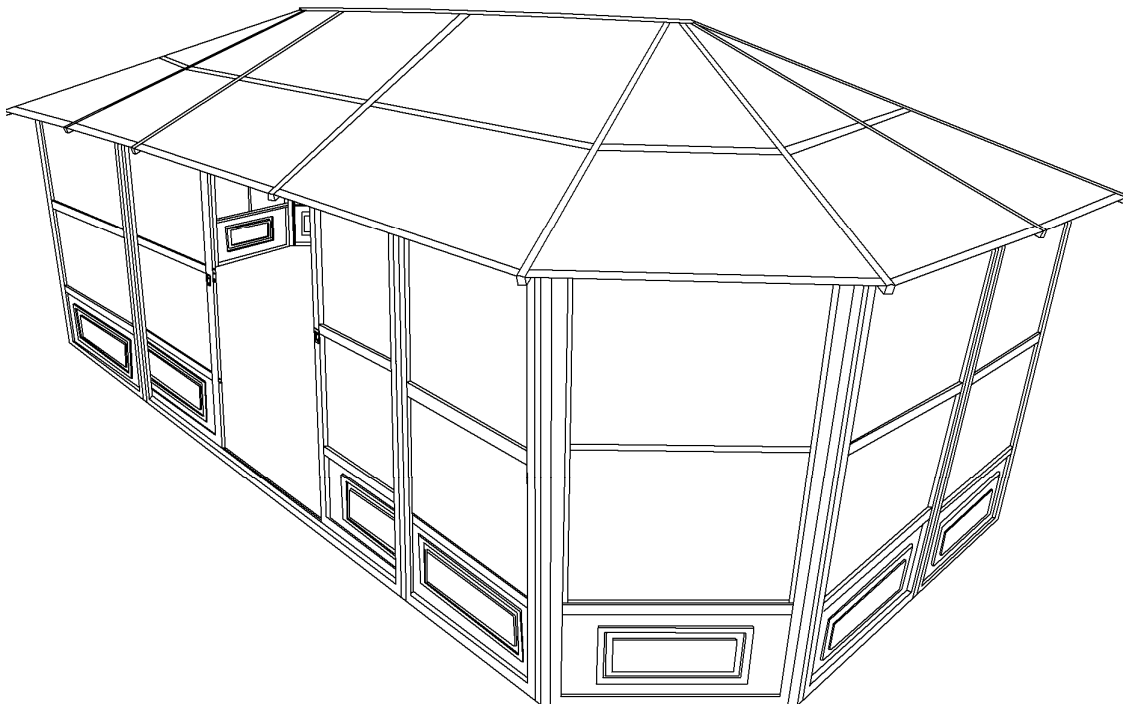

Assembly by more than one person is recommended.

Base Dimensions 12' ½"x18'11", Largest Dimensions 13'6"x20'4 ½" (see pg.14)

## Before you assemble the solarium

- It is important that this solarium be installed on a solid base with the provided screws. Otherwise, please ensure that you use anchors sufficient for your surface.
- The solarium should not be installed adjacent to trees or a sloped roof. Snow and ice may slide onto the solarium and cause it to collapse.

### Tools needed:

- Step ladder
- #2 Phillips screwdriver (supplied)
- Rubber mallet

Based on the location, decide where you would like to position the solarium. Remember the sliding door with "C" shape should be placed on the left side.

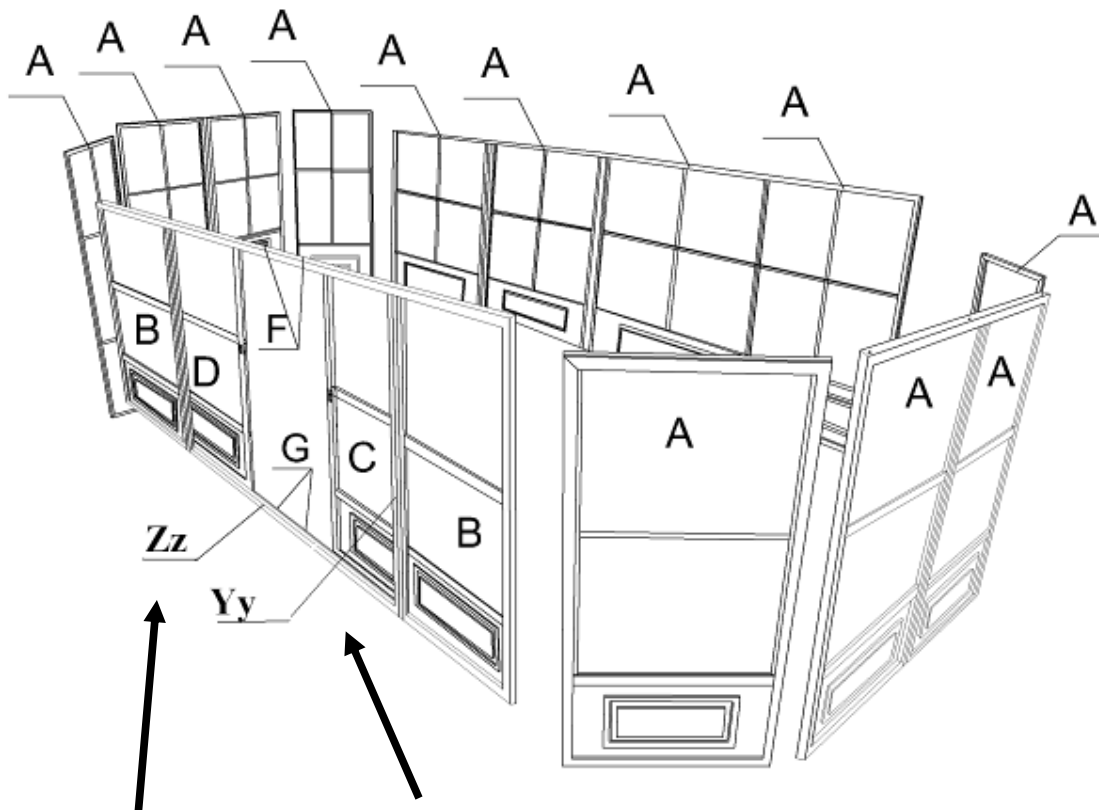

Sliding door with  
receiver channel

Regular sliding door

## 12x18 Solarium Assembly Instructions

### Step 1:

Before starting to assemble, please decide where you would like to position the door panels.

1. Stand up two regular frames (A), using two connecting pieces (E) and affix the panels (A) together
2. Assemble door frame separately. Assemble 2 vertical bars (Yy) with 2 horizontal bars (Zz). Make sure the shape of the aluminum matches the other parts to be joined. With a rubber mallet get them closed at the corners. Make sure to not damage the aluminum parts. Use screws (Z) to secure 4 corners manually, screwing all screws into frame 4 predrilled holes.
3. After assembling door frame, attach to frames (B) on either side, by sliding connecting piece (E) between the frame and the door frame.
4. When assembling angled panels (A, B), you should put the two panels at 135 degree angle then use the angled connecting pieces (I) and (J) to affix the panels together.

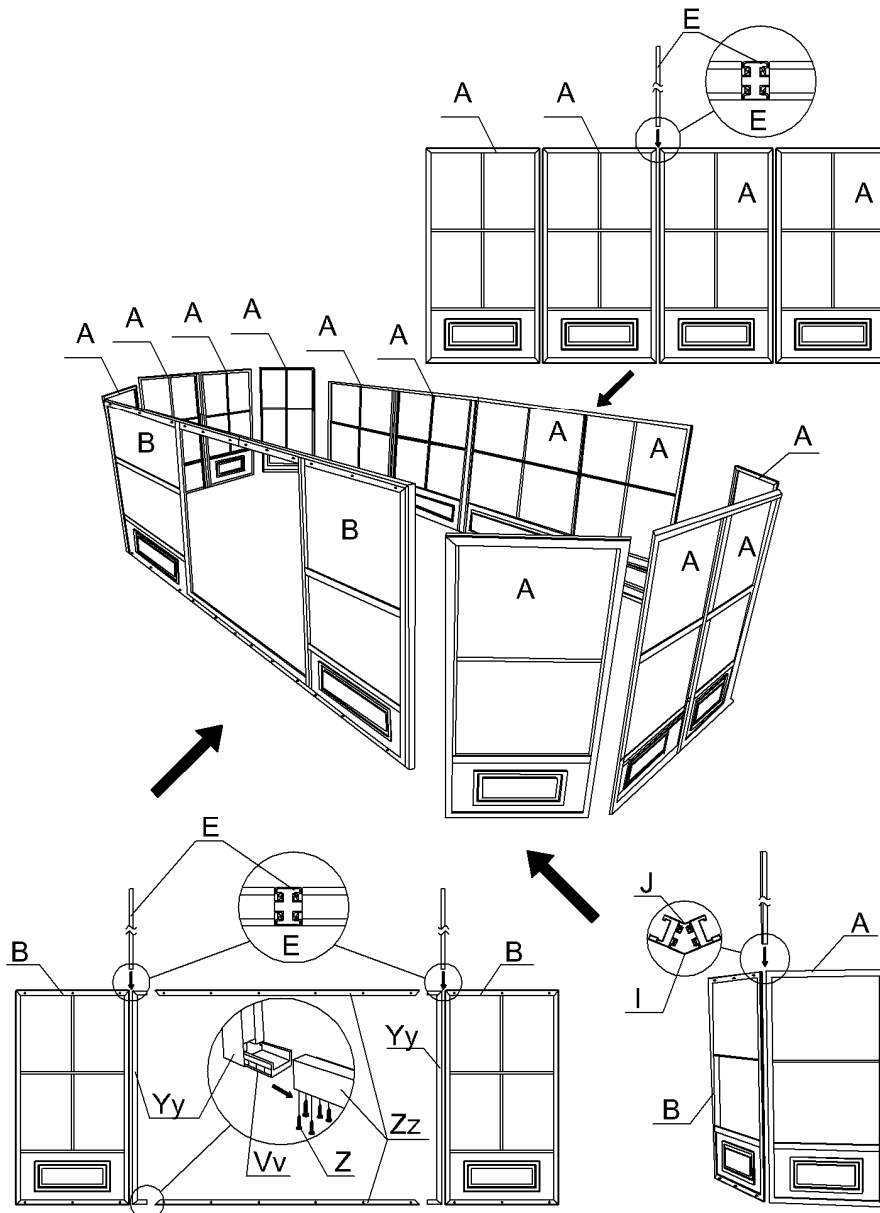

**Step 2:**

1. Place a bolt (Ww) and washer (Gg) through the top door rail (F) and door frame, and a female bolt (Cc-2) from the other side. Once all are inserted, tighten them all securely.
2. Secure bottom door rail (G), using a bolt (Cc) and washer (Gg).

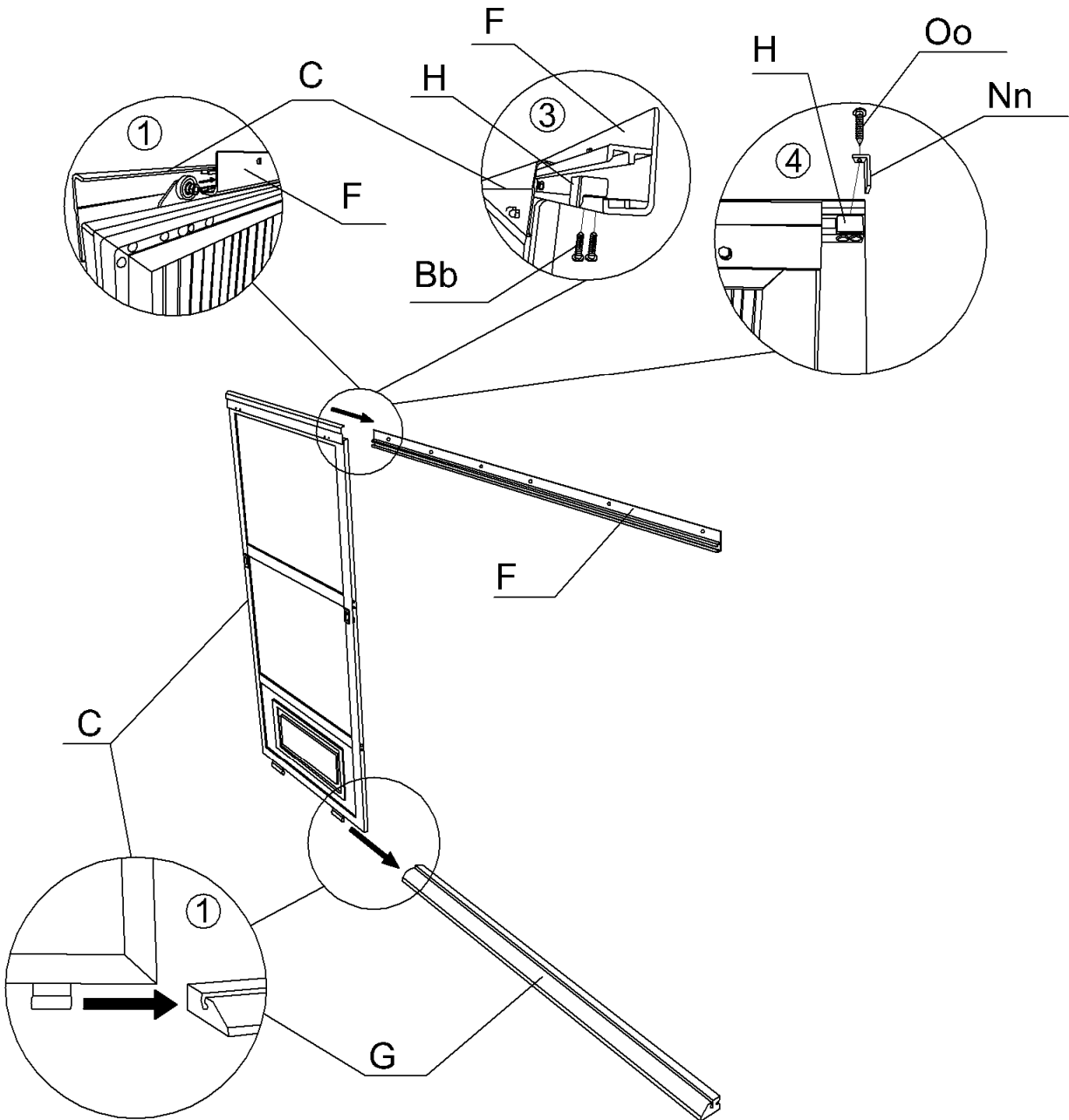

**Step 3: Please note the sliding door should be installed from the inside of the solarium.**

1. Attach the door wheels into the top of door rail (F) of the sliding door (C).
2. Attach the plastic piece into the bottom door rail (G) of the sliding door (C).
3. Use bolt (Bb) to affix the plastic stoppers (H), one on each end of the top door rail (F).
4. Then use screw (Oo) to affix the upper door rail end caps (Nn) one at each end of top rail (F).
5. The other side of top rail (F) is same as above step.

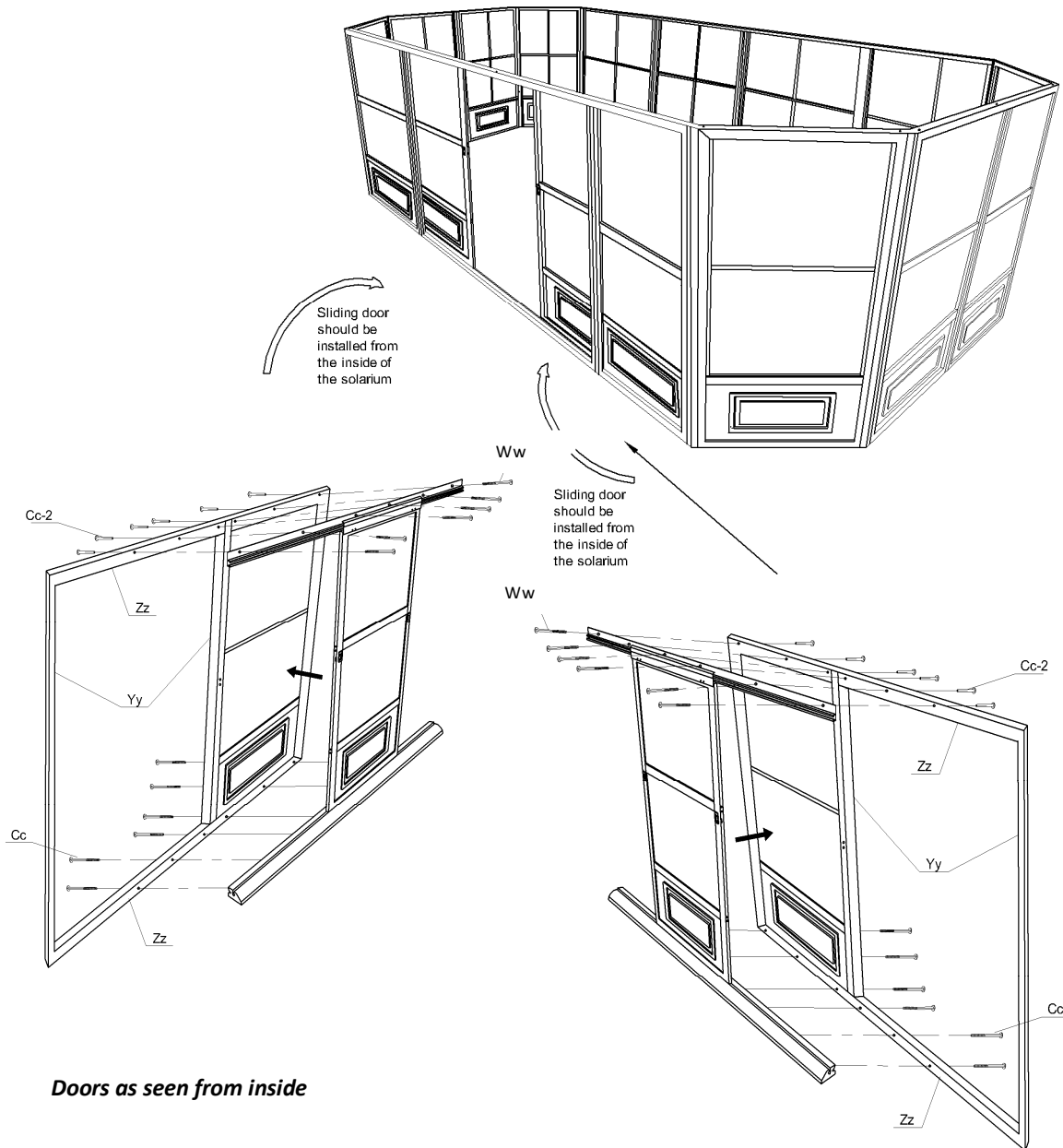

***Doors as seen from inside***

***Repeat steps 2 and 3 for the second door.***

**Step 4:**

1. Attach roof rafters (L) to the central hub (N) using bolt (Bb). (Caution: hub may be heavy, use support if needed)
2. Use screws (Bb) attached to brackets to affix the roof rafter (Xx) onto the top of the middle of the door panel.
3. Use screw (Z) to affix the other rafters (L) onto the top of panels going through the metal piece attached to the rafter (L).

**Note:** Rafters must be affixed where panels connect to each other.

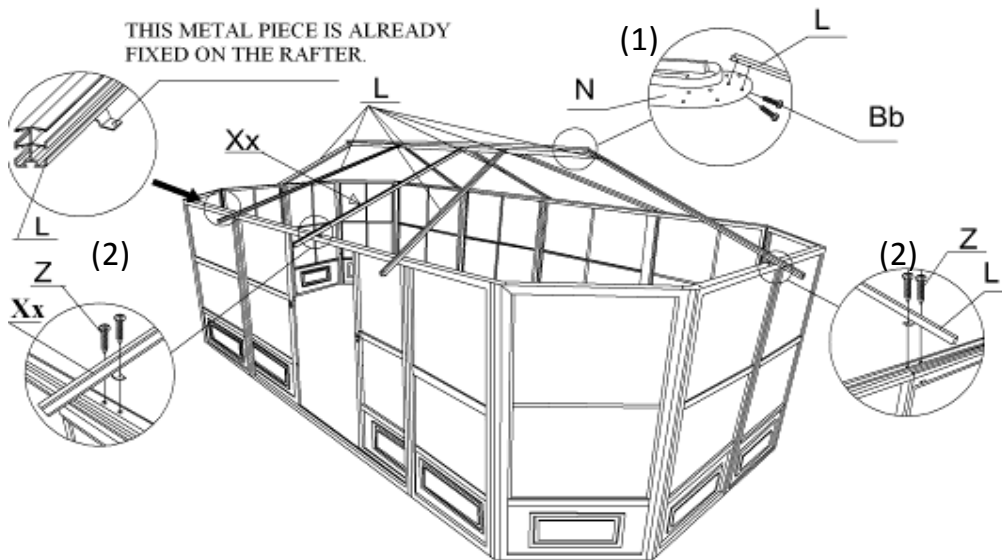

**Step 5:**

Use the same method to assemble roof rafters (K) for the angled panels. The metal piece affixed to the rafter (K) is adjustable, choose one hole to affix the rafter (K) to the top of the panel.

**Note:** 1) The K Rafter has 1 bracket with 2 holes. Attach roof with 1 screw when installing on top of the frames. Make sure that extra hole on bracket remains on the side of angled panel (at the corner). Then screw it to frames with screws (Z).

2) Do not tighten the bolts right away as you may have to adjust the angle when inserting the PC roof panels.

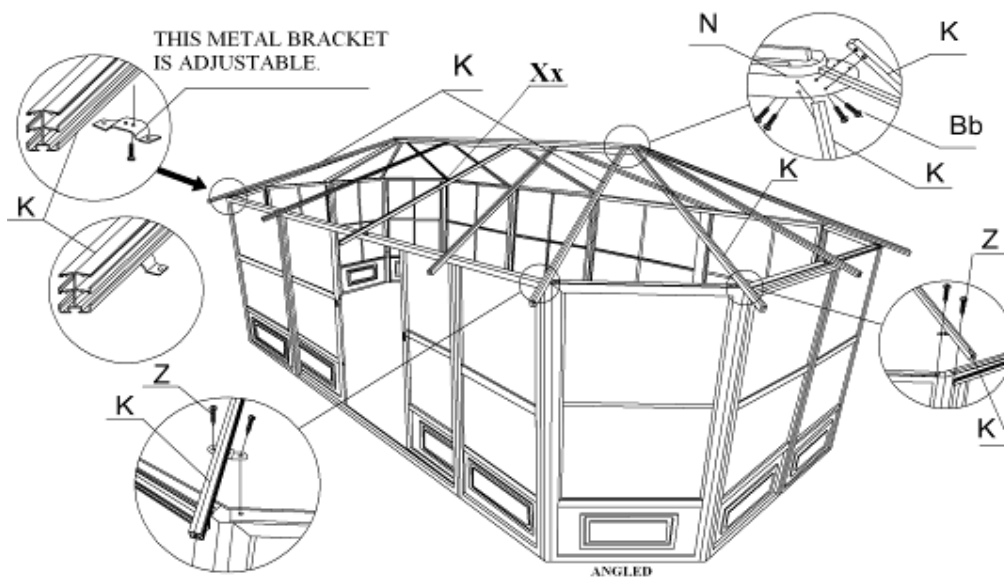

**Step 6:**

Use nut (Hh) and washer (Gg) to affix the top cap (M) to the central hub (N).

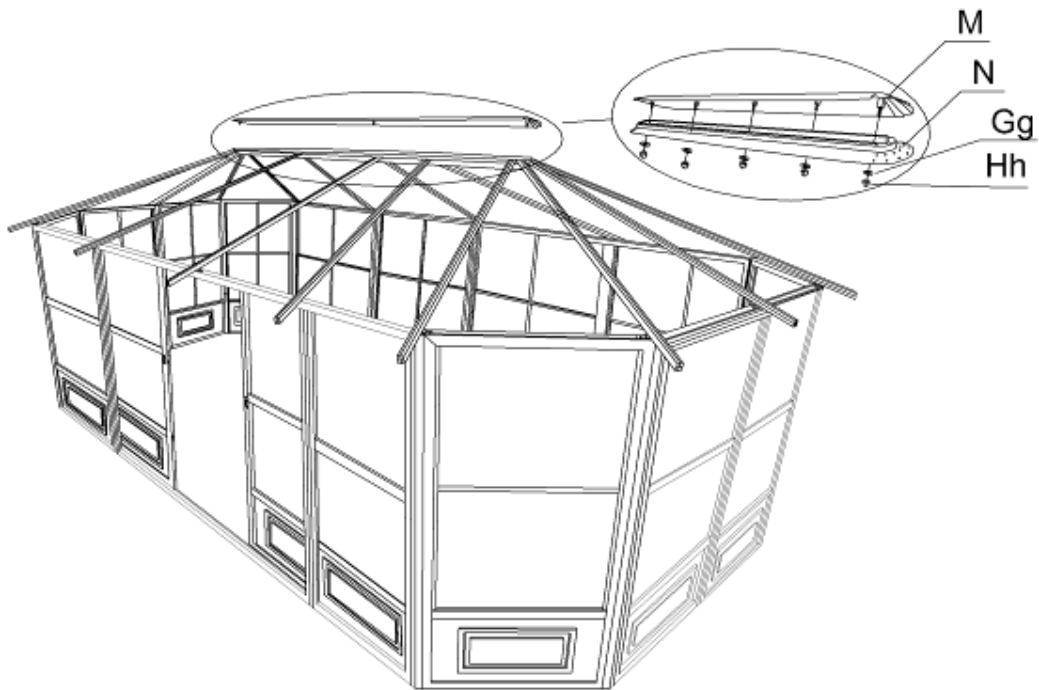

**Step 7:**

First remove the protective layer from the PC panels, then insert them (Y, Aa, Ll, Qq) between the roof rafters according to the below drawing instructions.

**Note:** the side that had the protective layer should be face down.

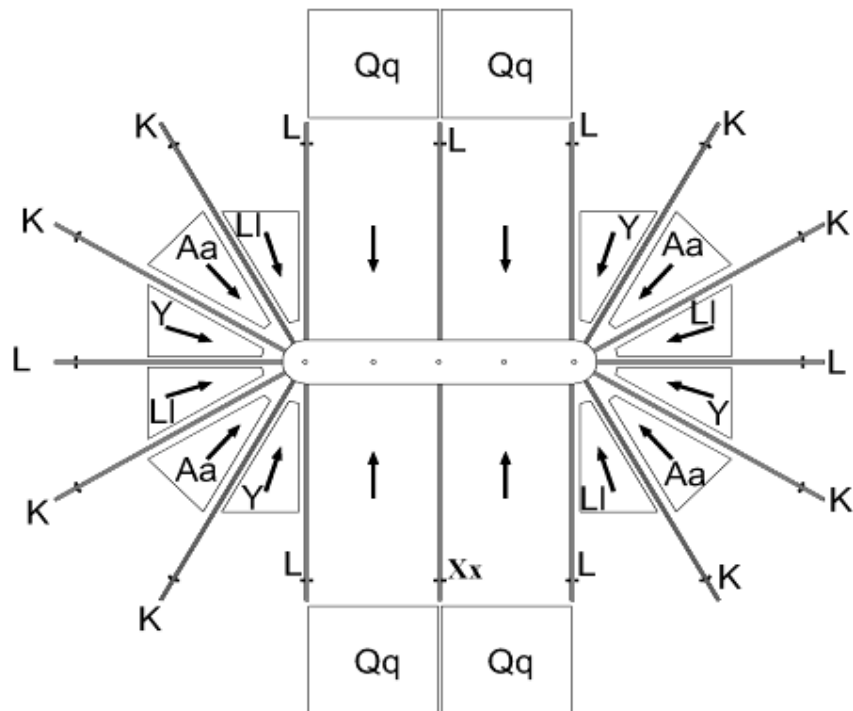

**Step 8:**

After inserting the upper PC panels, insert the aluminum middle roof joints (O, P, Q, Pp) into the roof rafters. The below drawing view is from inside the solarium looking up.

**Note:** the drain holes on the aluminum middle roof joints (O, P, Q, Pp) should be at the bottom.

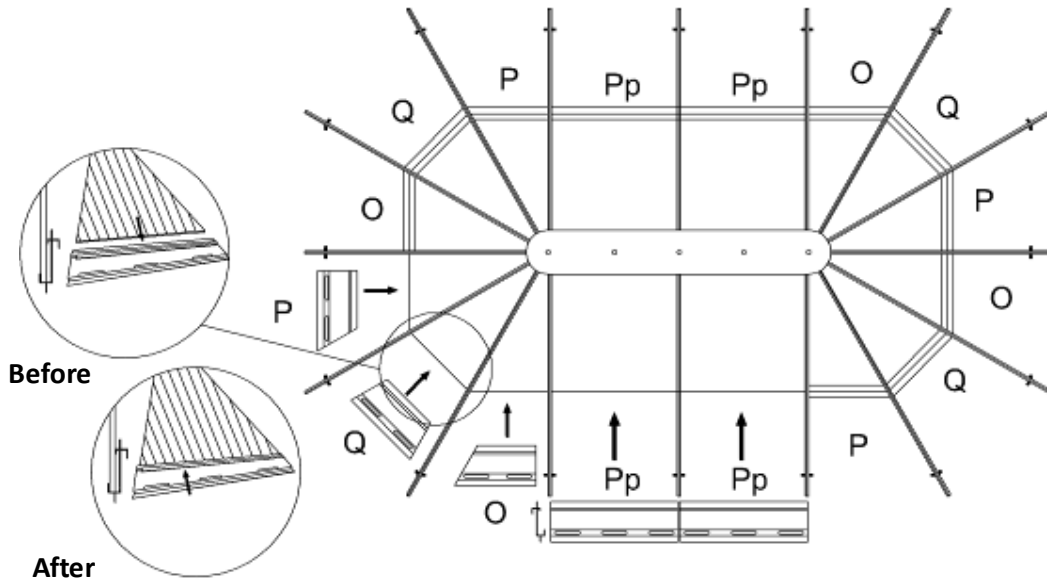

**Step 9:**

After the installation of the middle roof joints complete, insert the bottom PC roof panels (Jj, Kk, Mm, Rr) according to below drawing instructions. They should overlap about two inches under the upper PC roof panels and into the aluminum middle joints.

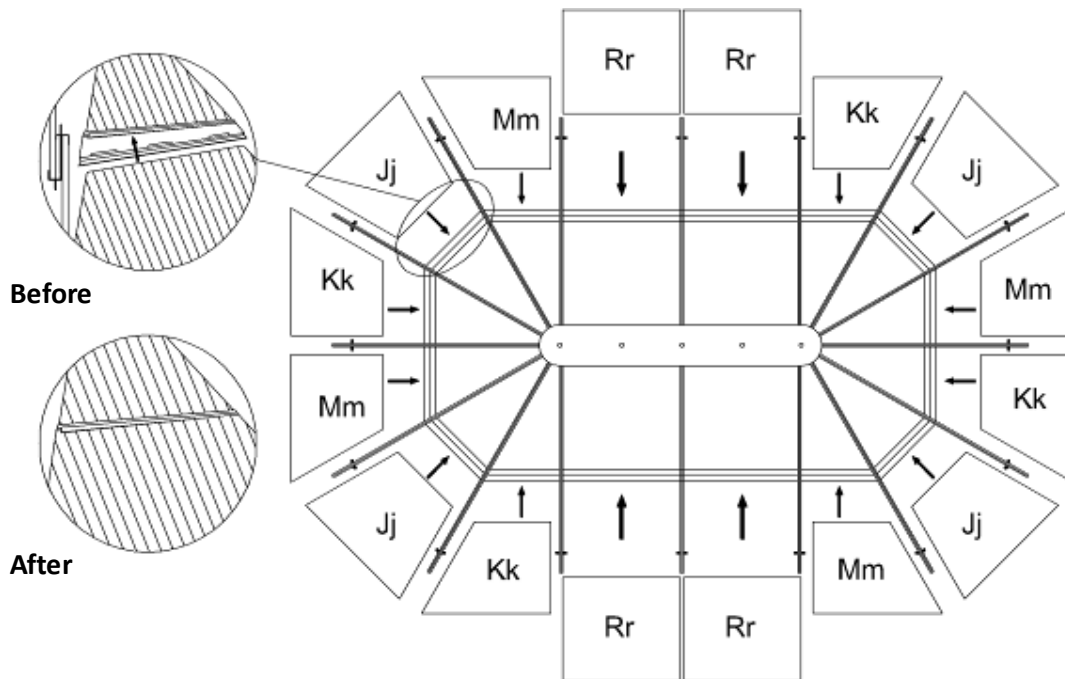



**Step 10:**

Once the PC roof is complete, use aluminum edging (S, U, W, Ss) to surround the edges of the PC roof, using bolt (Bb) and rafter cap (R), tighten securely.

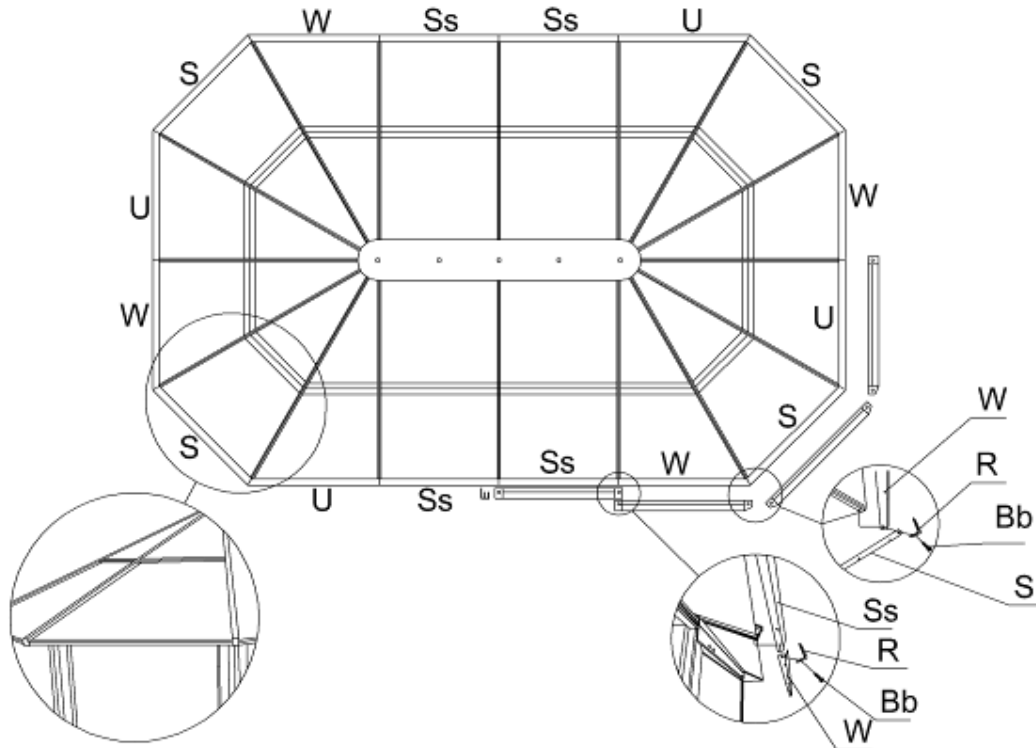

**Step 11:**

Once the installation of the edging complete, start affixing the roof cross bars (T, V, X, Tt) using bolt (Ff). Affix the top cross bars (Uu) onto the roof rafter (L) using bolt (Ff).

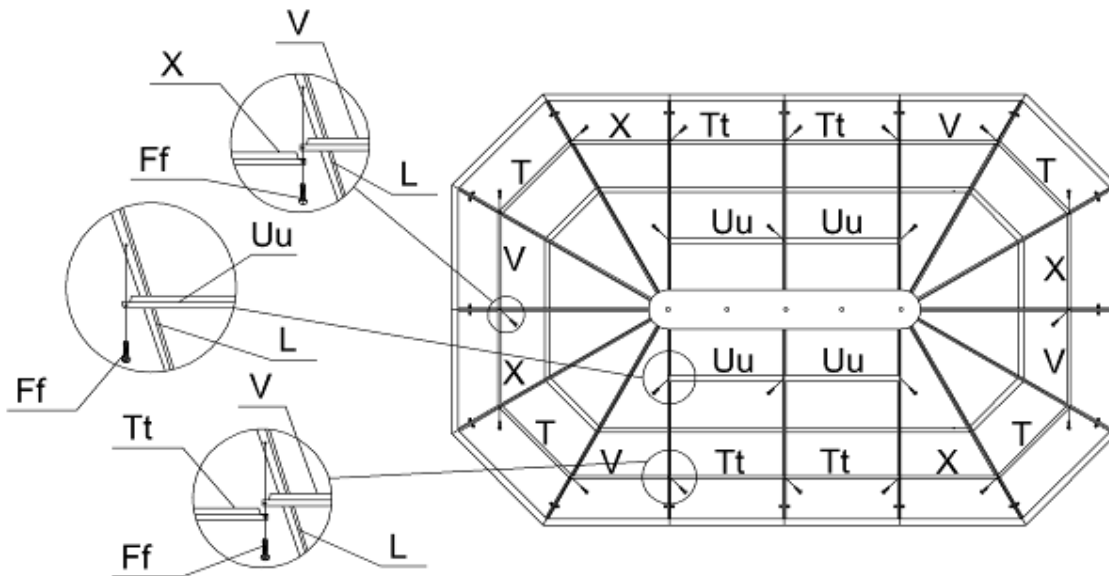

**Step 12:**

Inside each of the panels (A, B), push two plastic plugs (li) into the ground, and then screw down the panels using two screws (Ee) for each panels.

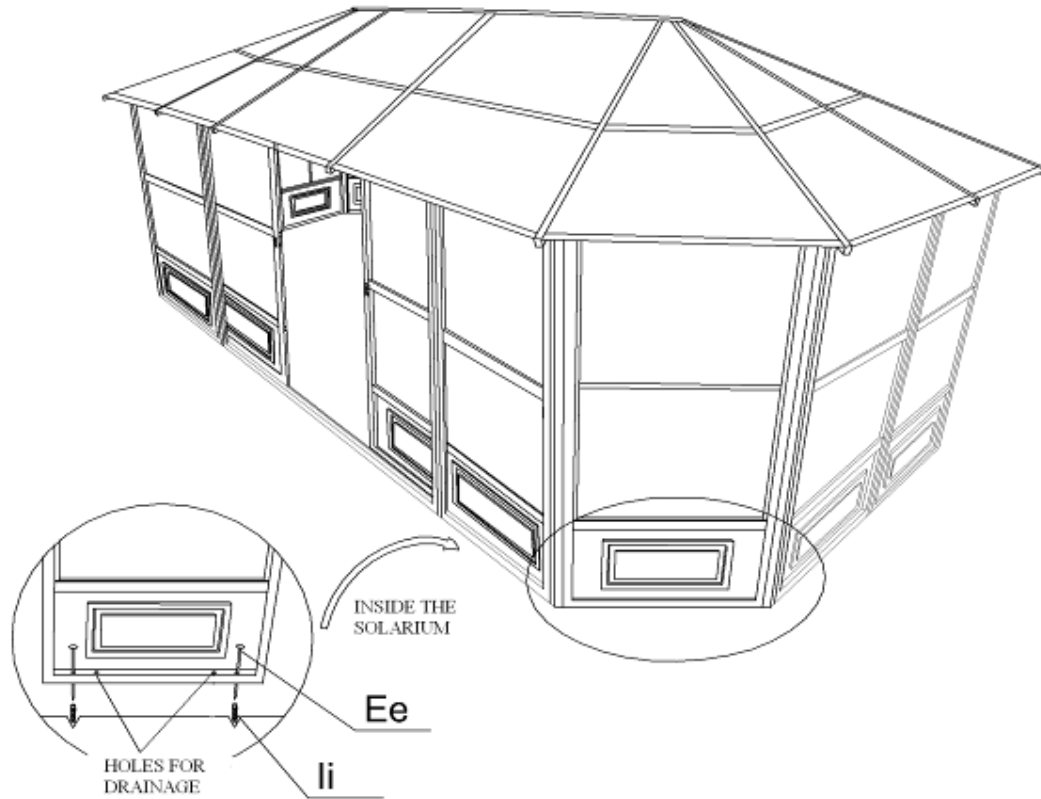





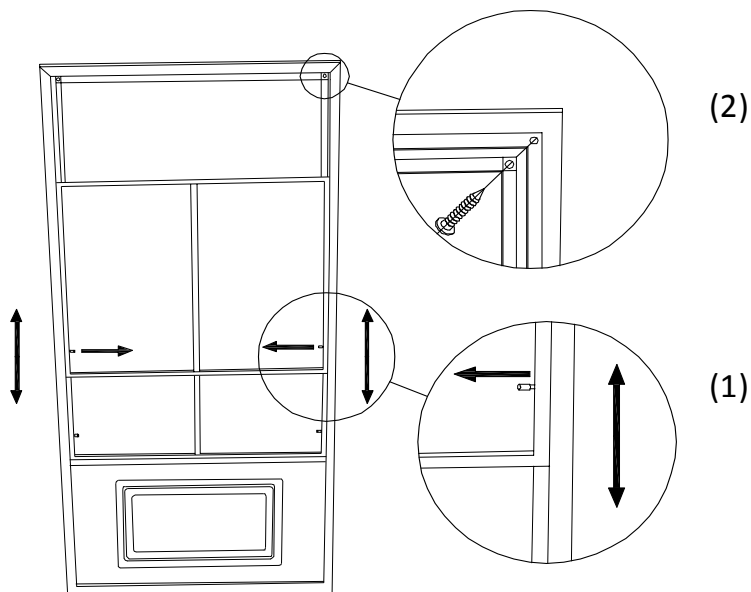



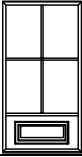
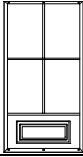
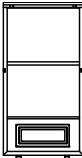
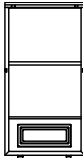

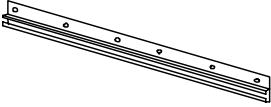
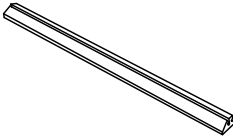
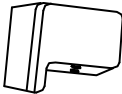
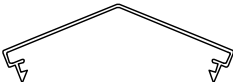
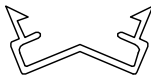

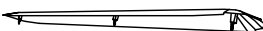

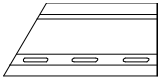
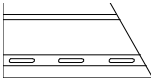
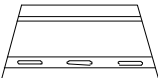

**Special notes:**

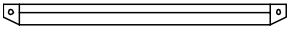

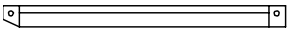
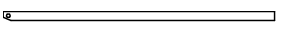
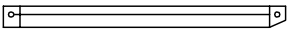

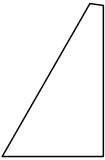
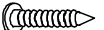
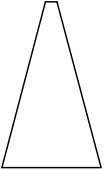
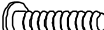
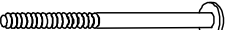
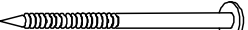
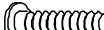

1. To remove windows (08-219), pull 1 pin out of the lock position and push the frame to the end of the track, then ease the window out of the tracks one side at a time.
2. To remove screening panel, first remove windows, then unscrew the 2 screws at the top corners of the screen frame.

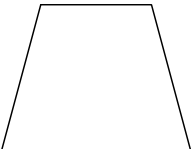
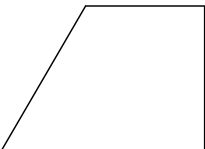

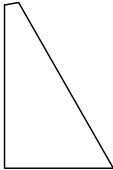
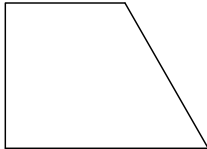
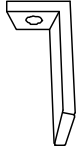
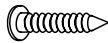
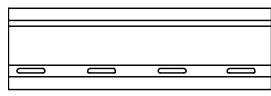
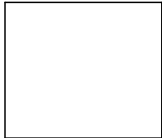
## 12X18 Solarium

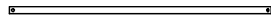
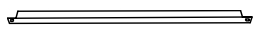
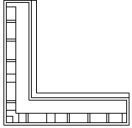
DESCRIPTION	QTY	DRAWING	DESCRIPTION	QTY	DRAWING
08-129 REGULAR FRAME A	12		08-130 FRAME NEXT TO DOOR B	2	
08-159 REGULAR SLIDING DOOR C	1		08-160 SLIDING DOOR WITH RECEIVER CHANNEL D	1	
08-133 CONNECTING PIECE E	14		08-162 TOP DOOR RAIL F	2	
08-163 BOTTOM DOOR RAIL G	2		08-138 PLASTIC STOPPER H	4	
08-139 135° ANGLED OUTSIDE CONNECTOR I	8		08-140 135° ANGLED INSIDE CONNECTOR J	8	
08-141 ROOF RAFTER K	8		08-142 ROOF RAFTER L	7	
08-164 TOP CAP M	1		08-166 CENTRAL HUB N	1	
08-145 MIDDLE ROOF JOINT O	4		08-146 MIDDLE ROOF JOINT P	4	
08-147 MIDDLE ROOF JOINT Q	4		08-148 ROOF RAFTER CAP R	16	

DESCRIPTION	QTY	DRAWING	DESCRIPTION	QTY	DRAWING
08-149 EDGING S	4		08-150 ROOF CROSS BAR T	4	
08-151 EDGING U	4		08-152 ROOF CROSS BAR V	4	
08-153 EDGING W	4		08-154 ROOF CROSS BAR X	4	
08-155 (24 1/4"x42 1/4") TOP ROOF LEFT PANEL Y	4		08-156 SCREW Z	64	 (M4*16mm)
08-157 (24 1/2"x46 1/2") TOP ROOF CORNER PANEL Aa	4		08-158 BOLT Bb	76	 (M6*16mm)
08-161 BOLT Cc	12	 (M6*70mm)	08-167 SCREW Ee	28	 (M6*100mm)
08-168 BOLT Ff	24	 (M6*12mm)	08-187 WASHER Gg	45	
08-189 ACORN NUT Hh	5		08-193 PLASTIC PLUG Ii	28	
08-195 (47"x47 1/2") BOTTOM ROOF CORNER PANEL Jj	4		08-196 (46 1/4"x43") BOTTOM ROOF LEFT PANEL Kk	4	

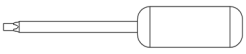
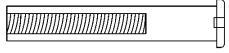
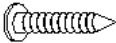
DESCRIPTION	QTY	DRAWING	DESCRIPTION	QTY	DRAWING
08-197 (24 1/4"x42 1/2") TOP RIGHT ROOF PANEL Li	4		08-198 (46 1/4"x43") BOTTOM ROOF RIGHT PANEL Mm	4	
08-134 UPPER DOOR RAIL END CAP Nn	2		08-135 SCREW Oo	36	 (M4*12mm)
08-170 MIDDLE ROOF JOINT Pp	4		08-172 (41 1/4"x42 1/4") TOP ROOF CENTER PANEL Qq	4	
08-171 (41 1/4"x43") BOTTOM ROOF CENTER PANEL Rr	4		08-173 EDGING Ss	4	
08-174 ROOF CROSS BAR Tt	4		08-175 TOP ROOF CROSS BAR Uu	4	
11-599 CORNER KEY Vv (INSTALLED IN Yy)	4		08-192 ROOF RAFTER ON THE MIDDLE OF THE DOOR Xx	1	
11-597 VERTICAL DOOR FRAME Yy	2		11-598 HORIZONTAL DOOR FRAME Zz	2	
12-036 PHILLIPS #2 SCREWDRIVER	1		12-037 FEMALE BOLT Cc-2	12	 M6*60mm
11-623 EXTRA SINGLE DOOR		AVAILABLE PLEASE CALL	08-219		Window for solarium (on the frames)
12-047 BOLT Ww	12	 M5*15mm			

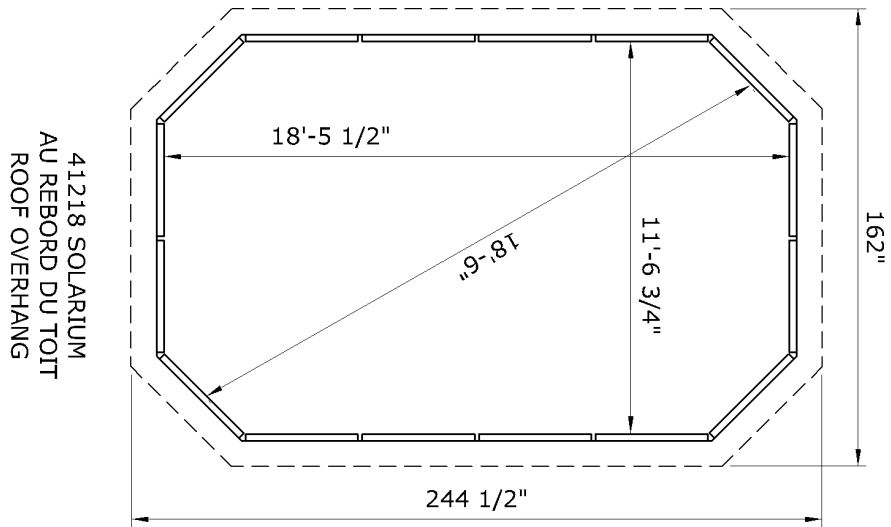
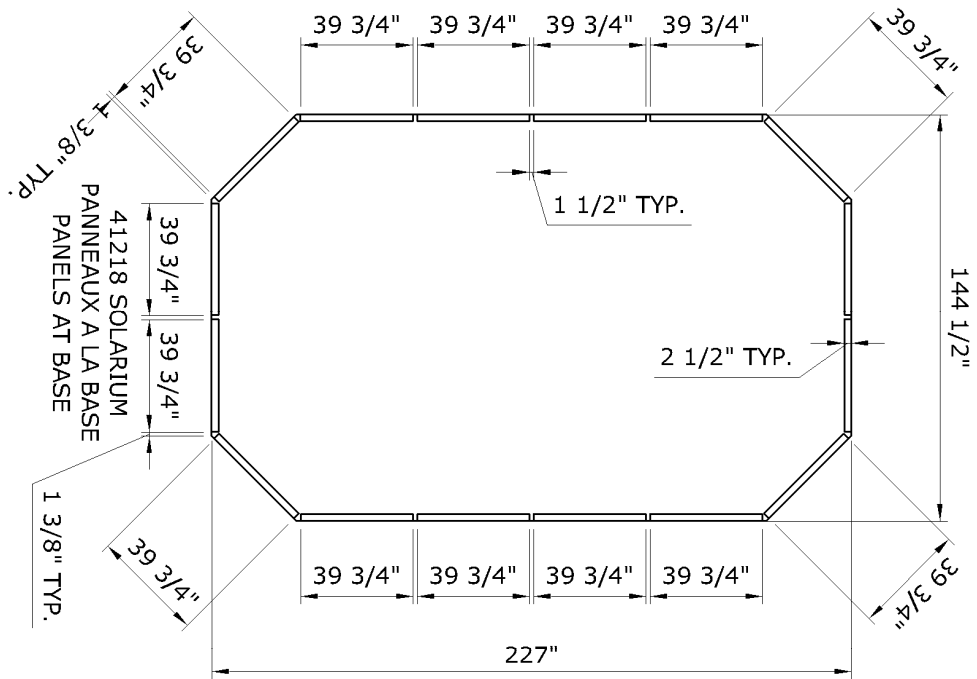

## MAINTENANCE NOTES

1. In case of a defective or damaged part, or for any other questions concerning the product, please contact the manufacturer directly.
2. Please have the parts list and part numbers on hand when ordering or requesting replacement parts.
3. The product should not be installed adjacent to trees or a sloped roof. Snow and ice may slide onto the roof and cause it to collapse.
4. While the product is designed for 4 seasons use, it is strongly recommended to clear snow from the roof on a regular basis.



## ONE YEAR LIMITED WARRANTY

This product has been designed and manufactured to meet the highest standards of quality and durability. Subject to the Conditions for Exercising the Warranty and the Limitations on the Warranty set forth below, it is warranted to be free of material and manufacturing defects for a period of **one year** from the date of purchase. Should the product become damaged, or the warranty period has expired, please contact Gazebo Penguin Customer Service Department for a complete schedule of replacement parts and prices.

## CONDITIONS FOR EXERCISING THE WARRANTY

In order to properly exercise your warranty, please comply with the following:

Carefully inspect the contents of the carton for missing or damaged components. Should you discover damaged or missing parts, **do not return the product to the place of purchase**, but contact Gazebo Penguin Customer Service Department at the numbers listed below:

**Montreal:** (514) 276-3485

**Elsewhere:** 1-800-737-7174

## LIMITATIONS ON THE WARRANTY

1. The product is not warranted against damages due to vandalism, abuse, or falling or thrown objects.
2. The product is not warranted against damages due to extreme weather conditions, such as thunderstorms, hail, strong wind or snow storms, or any other acts of God.
3. The product is only warranted in the event it is installed in accordance with the Gazebo Penguin's written instructions enclosed with the product.
4. The product is not warranted in the event it has been improperly anchored.