

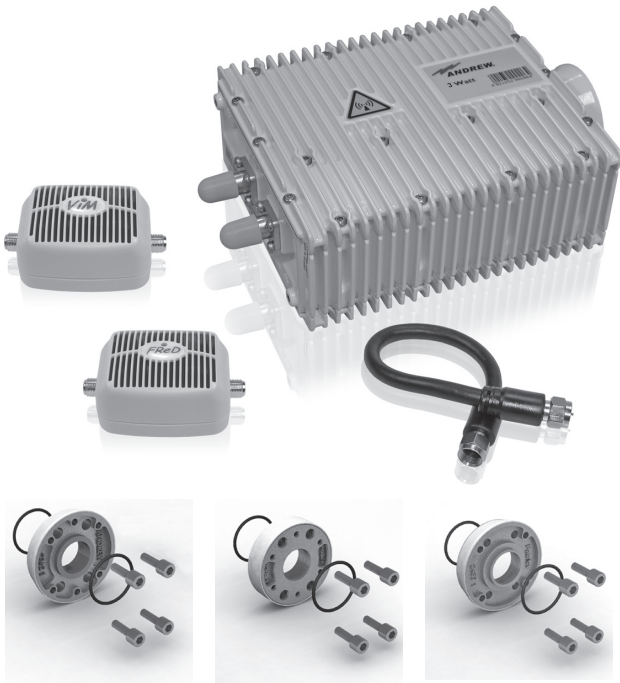

Andrew Corporation Earth Station Electronics
Universal VSAT Transceiver (UVT)



User and Installation Guide

2	1. Introduction
2	1.1. Scope
2	1.2. Warnings
2	1.3. Disclaimers
3	2. The Universal VSAT Transceiver
3	2.1. Description
4	3. Transceiver & Feedhorn Assembly
5	3.1. Assembly
7	4. VIM/FReD Selection & Installation
10	4.1. VIM installation
16	4.2. Installing FReD
17	5. Operation & Maintenance
17	6. Site Owner Information

Proprietary Notice:

The technical data contained herein is proprietary to **Andrew Corporation**. It is intended for use in installation and maintenance of **Andrew** supplied equipment.

This data shall not be disclosed or duplicated in whole or in part without the express written consent of **Andrew Corporation**.

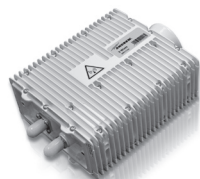

1 Introduction

1.1. Scope

This document is intended to provide information of a general nature to the supplier, installer and end user of the **Andrew Universal VSAT (Integrated) Transceiver**. It is highly recommended that this document is fully read and understood before installation and use of the transceiver. The **Andrew** transceiver is a professional product, which should only be specified and installed by professionals. It should not be relocated from its installed position except under the supervision of a professional. Observing these instructions will ensure that the **Andrew** transceiver offer many years of reliable service.

1.2. Warnings

This **Andrew Corporation** transceiver is a professional product. It contains an RF transmitter. It is therefore a source of nonionizing radio frequency radiation.

Qualified professionals with professional equipment are required to install and configure this unit. In case of emergency, disconnect the source of power for the transceiver. Usually this means disconnection of the indoor unit (or modem) from the power outlet.

In addition to the risk of damage or degradation to the equipment, failure to observe any or all of the following instructions may result in bodily harm, serious injury or even death.

For further safety information, see the chapter entitled **Site Owner Information**.

1.3 Disclaimers

ANDREW Corporation disclaims any liability or responsibility for damage caused as the results of misprints in this manual.

ANDREW Corporation disclaims any liability or responsibility for the results of improper or unsafe installation and maintenance practices.

ANDREW Corporation disclaims any liability or responsibility for violation of any legal ETSI, FCC or regulatory system homologation requirements caused by the use of the UVT system components.

2 The Universal VSAT Transceiver

2.1. Description

The **Universal VSAT Transceiver** (patent pending) allows the construction of a VSAT terminal regardless of the antenna/reflector or modem (IDU) being used. Included in the box set are the following items:

- -F16X (integrated VSAT transceiver)
- VIM10 (VSAT installation module)
- FReD10 (Frequency reference device)
- UFAK (Universal feed adaptor kit)
- IFL cable
- User Manual

The installation of the **UVT** is summarized in the flow chart. A more detailed breakdown of the installation sequence is provided in the following sections.

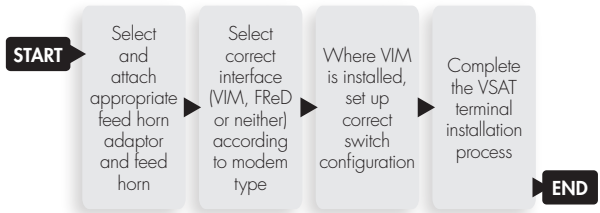
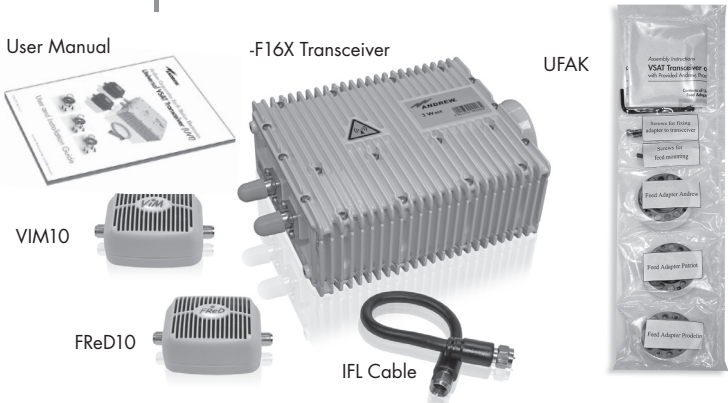

Figure 1 Flow chart illustrating the UVT based ODU set-up process



3 Transceiver & Feedhorn Assembly

IMPORTANT

DO NOT connect the power source (the cables from the modem/indoor unit) **before** assembly of the **transceiver and antenna** is complete.

The UVT box kit contains a **UFAK – Universal Feed Adaptor Kit** (pictured).

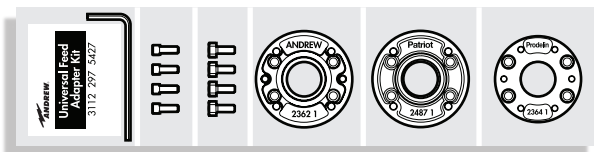

Figure 2 *UFAK - the Universal Feed Adaptor Kit*

By way of example the installation sequence below demonstrates the set up of the **UVT** with **Andrew** feedhorn and adaptor. The principal can be easily extended to the fitting of Prodelin or Patriot feed horns and adaptors.

Before assembly of the transceiver electronics to the dish antenna, a feedhorn (and if necessary, adaptor) must be attached to the transceiver.

Check the parts for damage, especially to the 3 interfaces (2 connectors and OMT port).

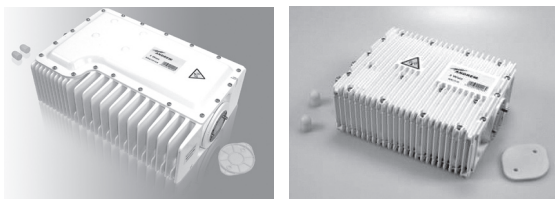

Figure 3 *Removal of the protective connector & port covers*

Removal of the adaptor kit from its plastic wrapper completes the preparation process.

3 Transceiver & Feedhorn Assembly

UVT Type	TX Power	RX polarization X-Polar to TX	RX Polarization Co-Polar to TX
XR3 Series	2, 3 and 4 Watt Versions	Yes	No
DR5 Series	3, 4 and 5 Watt Versions	Yes	Yes
DR7 Series	6, 7 and 8 Watt Versions	Yes	Yes

3.1 Assembly

The adaptor/transceiver interface may now be assembled.



Figure 5 *Transceiver & adaptor, showing correctly located adaptor ring*

With the adaptor sealing ring secured in the correct position, use the four screws supplied to connect the adaptor to the transceiver as shown in Figure 6.



Figure 6 *Connecting the adaptor to the transceiver*

Care should be taken not to overtighten hardware.

3 Transceiver & Feedhorn Assembly

3.1 Assembly

The final task is to attach the feedhorn. At this point, it is important to note two things

- The integrity of the sealing ring
- The position of the skew angle indicator which is cast into the feedhorn body itself and used to ensure polarization alignment with the satellite



Figure 7 *The feedhorn/adaptor interface with adaptor ring*

Ensure that the sealing ring is in place. Orient the feedhorn so that the zero degree skew indicator is aligned with the transmit polarization. (Polarization is marked on the transceiver). Attach the feedhorn to the adaptor/transceiver assembly.

3 Transceiver & Feedhorn Assembly

3.1 Assembly



Figure 8 *Connecting the feedhorn to the adaptor*

Care should be taken not to overtighten hardware.

Depending on the particular modem and VSAT network set-up requirements, assembly of the transceiver and feed is now complete and is ready for integration with the antenna.

4 VIM/FReD Selection & Installation

Included with the **UVT** are two system configuration devices. Deciding which to install depends on the modem being used.



Some common L-band modems and manufacturers are listed in the following table. Use the table to identify which configuration should be used, then refer to the installation sections for more detailed information on how to set-up and connect the device.

In the event that the specific modem is not listed, use VIM as the default installation device.

4 VIM/FReD Selection & Installation

10 MHz Reference Available On Modem RX If Port?	950 - 2150 MHz RX IF Input Bandwidth?	SatLabs IFL Switching Protocol (DC Level & 22 KHz Tone)?	Configuration	Example Modem
No	No	No	4	Gilat SkyEDGE (XR Series Only)
No	No	Yes	1	
No	Yes	No	1	HNS HX-150; ViaSat (Linkstar & Surfbeam); Advantech
No	Yes	Yes	2	Shiron iRG-Series; NDSatCom hlPerion
Yes	No	No	1	iDirect 3000-, 5000-, & 7000- Series; NDSatCom SkyWAN; Comtech EF; Radyne
Yes	No	Yes	1	Radyne; Comtech EF
Yes	Yes	No	1	
Yes	Yes	Yes	3	STM-1910; HNS HX - 200

Configuration 1

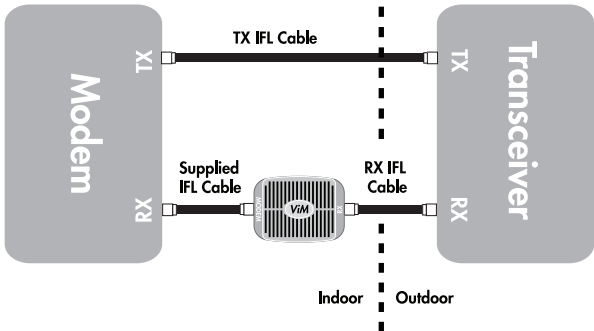

Configuration 2

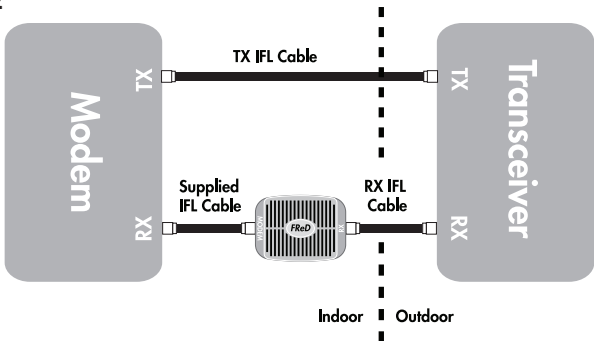

4 VIM/FReD Selection & Installation

10 MHz Reference Available On Modem RX If Port?	950 - 2150 MHz RX IF Input Bandwidth?	SatLabs IFL Switching Protocol (DC Level & 22 KHz Tone)?	Configuration	Example Modem
No	No	No	4	Gilat SkyEDGE (XR Series Only)
No	No	Yes	1	
No	Yes	No	1	HNS HX-150; ViaSat (Linkstar & Surfbeam); Advantech
No	Yes	Yes	2	Shiron iRG-Series; NDSatCom hlPerion
Yes	No	No	1	iDirect 3000-, 5000-, & 7000- Series; NDSatCom SkyWAN; Comtech EF; Radyne
Yes	No	Yes	1	Radyne; Comtech EF
Yes	Yes	No	1	
Yes	Yes	Yes	3	STM-1910; HNS HX - 200

Configuration 3

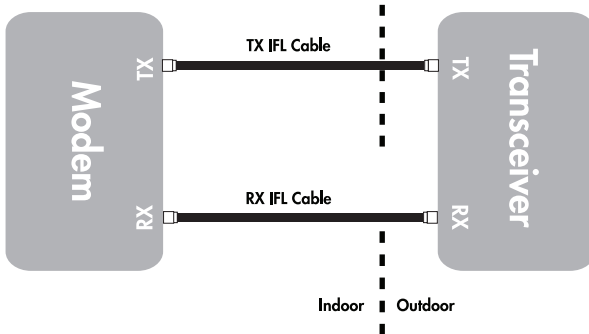

Configuration 4 (XR Series Only)

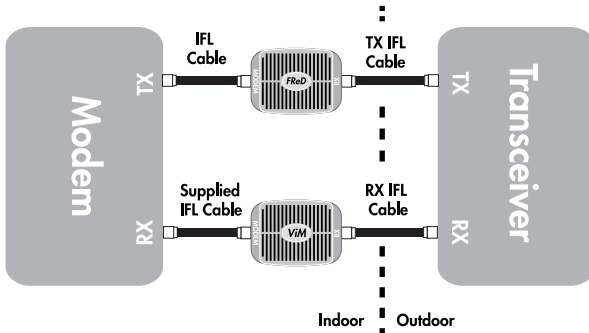

4 VIM/FReD Selection & Installation

4.1 VIM Installation

Installation and set-up may be achieved in a few simple steps. Note that your equipment provider may have already set-up the correct configuration prior to shipping of the unit, in which case, only the physical installation is required.

VIM may be installed only in the outbound/receive path. Note also that both VIM and FRED form a permanent part of the installation. Removal of **any or either of the devices after installation** will alter the functionality of the receive path, and unless properly supervised, will likely result in the discontinuance of the terminal service.

(Refer to Figure 9 – VIM-enabled terminal concept)

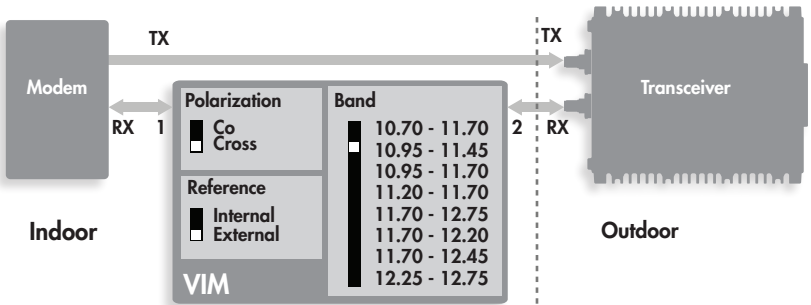

Figure 9 VIM-enabled terminal concept

4 VIM/FReD Selection & Installation

4.1 VIM Installation

The first step in the **VIM** installation process is to identify the correct switch positions for the application.

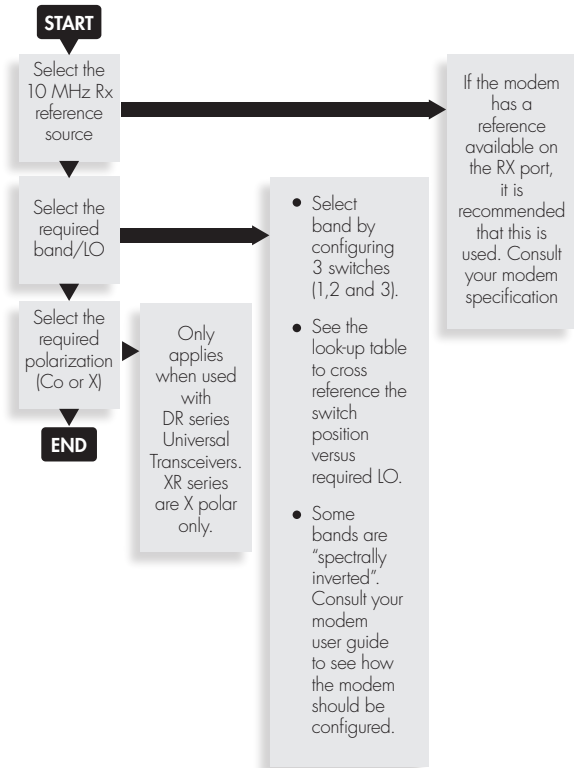

Figure 10 Flow chart describing the VIM switch set-up

IMPORTANT!

- Polarization setting for XR3 series must always be X-polar.
- VIM supply voltage for DR5 series must always be >18.5 V
- On cable runs of more than 30 meters, premium coax cable must be used with a solid copper center conductor.

4 VIM/FReD Selection & Installation

4.1 VIM Installation

On the under side of the **VIM** unit, there is a rubber boot. Removal of this rubber boot allows access to the configuration switches.

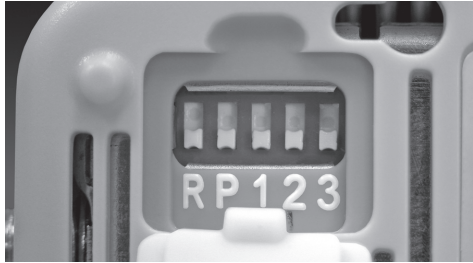

Figure 11 Locating the VIM configuration switches, rubber boot removed



Label	Description	Switch Position		Notes
		Up	Down	
R	Sets the source of the 10 MHz reference	VIM internal	Modem	
P	Sets the polarization	Co-polar	Cross-polar	Applies only to DR-series*
1	Selects the LO/band	See the band selection table		
2				
3				

* For all XR-series installations the "P" switch should be set down

Figure 12 Switch layout and function table

4 VIM/FReD Selection & Installation

4.1 VIM Installation

The 3 switches allocated to band/LO selection, are set-up according to the table.



Example on left is configured for:

Internal Reference: R is Up

Co-Polar: P is Up

Universal Low: 1 is Up

2 & 3 are Down

Name	RF Input/GHz		LO/GHz	IF Output/MHz		Switch# /Position			Spectrum Inversion
	Low	High		Low	High	1	2	3	
US Domestic	11.70	12.20	13.15	950	1450	down	down	up	Yes
Euro-Low	10.95	11.45	12.40	950	1450	down	up	down	Yes
-	11.70	12.45	13.40	950	1700	down	up	up	Yes
Universal Low	10.70	11.70	9.75	950	1950	up	down	down	No
Universal High	11.70	12.75	10.60	1100	2150	up	down	up	No
-	11.20	11.70	12.65	950	1450	up	up	down	Yes
Euro -High	12.25	12.75	13.70	950	1450	up	up	up	Yes
-	10.95	11.70	12.65	950	1700	up	up	down	Yes

In order to find the IF output from the UVT receiver/LNB, the following formula may be used.

$$f_{IF} = |f_{TRANS} - f_{LO}|$$

Where;

f_{IF} intermediate frequency from VIM output to modem

f_{TRANS} outbound transponder frequency

f_{LO} local oscillator frequency setting on VIM

Worked Examples

Transponder frequency is 12.03 GHz.

- Using the Universal High band (LO = 10.60 GHz), the transponder can be found at... $12.03 - 10.60 = 1.43$ GHz
- Using the US Domestic band (LO = 13.15 GHz), the transponder can be found at... $12.03 - 13.15 = -1.12$ GHz = 1.12 GHz

4 VIM/FReD Selection & Installation

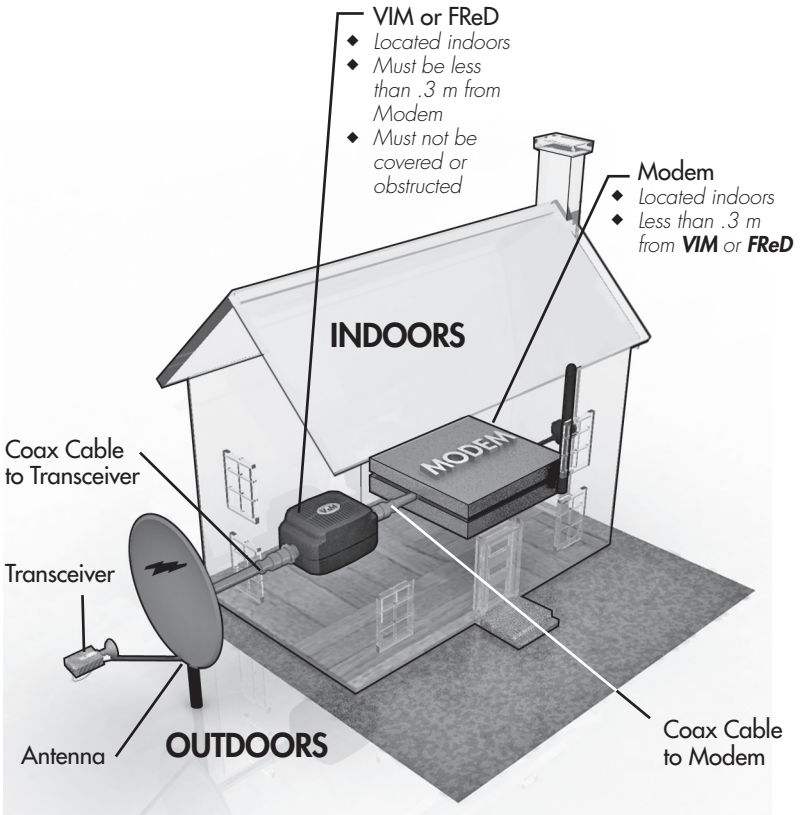

4 ViM/FReD Selection & Installation

4.1 ViM Installation

With the switches set-up according to the requirements, replace the rubber boot.

The configured **ViM** may now be connected to the transceiver (and modem, if appropriate at this point), and installation of the terminal may now be continued. **ViM** has two connectors (*Figure 13 - ViM, and the 2 labelled ports, "MODEM" and "RX"*). Identify these ports, and ensure that "RX" is connected only to the outdoor unit, and that "MODEM" is connected only to the indoor unit (or modem).



Figure 13 *ViM, and the 2 labelled ports, "MODEM" and "RX"*

Installation of the electronics is now complete, switch on the modem and continue with the satellite terminal setup process. When power is applied to the **ViM** module from the modem, a red LED will light to show the operation. **On continuously** indicates **ViM** is in frequency conversion mode. **Double flash** indicates **ViM** is in transparent mode. **Single flash** indicates **ViM** is not operating correctly

4 VIM/FReD Selection & Installation

4.2 FReD Installation

Fitting the **FReD** ancillary is extremely simple. There are no configuration switches. The **FReD** device is fitted in the outbound/receive path, between the ODU/transceiver and the IDU/modem.

Identify from the **FReD** module which is the "MODEM" (modem/IDU) port, and which is the "RX" (RX, ODU) port. (See *Figure 14 - Illustration of FReD, with two labelled ports for an explanation.*)

Connect the **FReD** unit in line, between the modem RX port and the transceiver RX port.

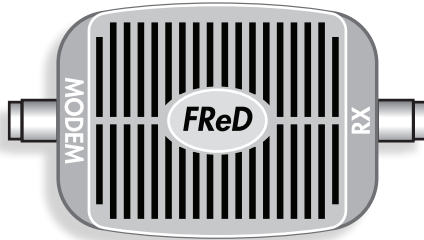

Figure 14 *Illustration of FReD, with two labelled ports*

Installation of the electronics is now complete. Switch on the modem and continue with the satellite terminal setup process. When power is applied to the **FReD** module, a blue LED will light to show the operation.

5 Operation & Maintenance

The **UVT** transceiver operation is controlled by the modem. No operational intervention is necessary after installation is complete.

If the network or system becomes unusable, it is unlikely that the transceiver is the source of the problem. Consult your network operator or service provider, or modem/indoor unit operating guide for instructions.

The **UVT** transceiver is maintenance free. In the unlikely event of failure, the transceiver shall be professionally removed, replaced and disposed of. There are no user serviceable parts or components inside. Do not open the transceiver.

6 Site Owner Information

Ensure that the site owner information sheet is handed over to those responsible for the installation site. It is important for the health and safety of the owner, and for the continued high performance of the system, that the information sheet is read and understood.

The site owner safety sheet is depicted on the following pages.

6 Site Owner Information



Do

Take precautions to keep children and pets away from the installation site.



Inspect from a safe distance, the installation after instances of severe weather (strong winds or extreme temperatures) or impact. If damage is suspected, disconnect the indoor unit or modem from the power outlet and seek professional advice.

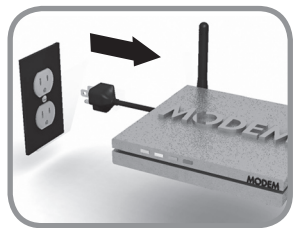
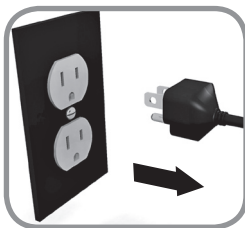

Don't



DO NOT

Look into the feedhorn or waveguide.

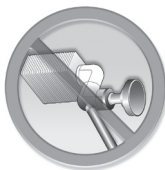

DO NOT

Modify the approved feed horn and adaptor set-up.

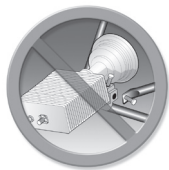

DO NOT

Operate the device when not securely attached to the intended antenna installation.



DO NOT

Operate the device without a feedhorn.

Don't



DO NOT

Use a non-matched antenna/feedhorn/adaptor combination.



DO NOT

Obstruct the area between the antenna and the transceiver.



DO NOT

Attempt to dismantle the unit – there are no user serviceable parts inside.



DO NOT

Attempt to service or modify the installation.

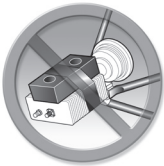

DO NOT

Attach any objects (heavy or otherwise) to any part of the installation.

Avoid



AVOID standing in front of the communications installation.

AVOID continued operation of the installation, if damage to the antenna or transceiver has occurred or is suspected.

