

ENDURANCE®

T6iHRC



Endurance® T6iHRC Treadmill

User Manual



Warning

When using an electrical appliance, basic precautions should always be taken, including the following:

- Read all instructions before using your treadmill. These instructions are written to ensure your safety and to protect the unit.
- Before beginning any fitness program, you should obtain a complete physical examination by your physician.

Danger

To reduce the risk of electrical shock always unplug the treadmill from the electrical outlet immediately after using and before cleaning.

Warning

To reduce the risk of burns, fire, electric shock, or injury to persons, take the following precautions:

- When it is plugged in, do not leave the treadmill unattended. Unplug the treadmill from the power source when it is not in use, and before adjusting, putting on or taking off parts.
- Do not allow children, invalids, or disabled persons on or near the treadmill without adult supervision. Close supervision is necessary.
- Use the treadmill only for its intended use as described in this manual.
- Do not use accessory attachments that are not recommended by the manufacturer—such attachments might cause injuries.
- Never operate the unit if it has a damaged cord or plug, if it is not working properly, if it has been dropped or damaged, or dropped in water. Return the treadmill to a service center for examination and repair.
- Keep the power cord and plug away from heated surfaces.
- Never block the air openings on the hood while operating the Treadmill. Keep the air openings clean and free of lint, hair, or anything that might impede the free flow of air.
- Never drop or insert objects into any opening. Keep hands away from moving parts.
- Do not use outdoors.
- Do not operate where aerosol (spray) products are being used or where oxygen is being administered.
- To disconnect, turn the power switch to the OFF (O) position, then remove the power plug from the wall outlet.

Warning

Connect the treadmill to a properly grounded outlet only. See Grounding Instructions.

IMPORTANT SAFETY INSTRUCTIONS

SAVE THESE INSTRUCTIONS

Personal Safety

- Assemble and operate the treadmill on a solid, level surface. Locate the treadmill at least 4 feet from walls or furniture. Keep the area behind the treadmill clear.
- Check the treadmill before each use.
- Completely assemble the treadmill before using it.
- Turn OFF and unplug the treadmill when adjusting or working near the rear roller. Do not adjust the running belt when someone is standing on the unit.
- Keep all electrical components, such as the motor, power cord, and ON/OFF (I/O) switch, away from water or other liquids to prevent shock. Do not set anything on the handrail, electronic console, or hood. Never place liquids on any part of the unit except the water bottle holder and only capped spill-proof water bottles are recommended.
- Always attach the safety clip to your clothing at waist level prior to beginning your workout. The safety clip is connected by a cord to the magnetic safety key in the electronic console. If you encounter difficulties, you can stop the running belt by pulling on the cord to disengage the magnetic safety key from inside the console. To resume operation, the magnetic safety key must be replaced.
- When the treadmill is not being used, remove the magnetic safety key and store it in a safe place to prevent unauthorized use.
- Wear proper exercise clothing and shoes for your workout—no loose clothing. Do not wear shoes with heels or leather soles. Check the soles of your shoes and remove any dirt and embedded stones. Tie long hair back.
- Keep all loose clothing and towels away from the running surface. The running belt will not stop immediately if an object becomes caught in the belt or rollers.
- Before the running belt begins moving (prior to your workout), and after it stops (at the end of your workout), straddle the belt by placing your feet firmly on the right and left side platforms.
- Use care when getting on or off the treadmill. Use the handrails whenever possible. Step onto the running belt when the speed is at or below 1 mile per hour (1.6 kilometers per hour). Never step off the treadmill while the running belt is moving.
- Never turn ON the treadmill when someone is standing on the machine.
- Keep your body and head facing forward. Never attempt to turn around on the treadmill when the running belt is moving.

- Do not rock the unit. Do not stand on the handrails, electronic console, or hood.
- Do not attempt to service the treadmill yourself other than the assembly and maintenance instructions found in this manual.
- Do not overexert yourself or work to exhaustion.
- Stop your workout immediately if you feel any pain or abnormal symptoms, and consult your physician

Grounding Instructions

Your Endurance Treadmill must be grounded. If it should malfunction or break down, grounding provides a path of least resistance for electric current which reduces the risk of electrical shock. The treadmill is equipped with a power cord having an equipment-grounding conductor and a grounding plug. The plug must be inserted into an appropriate outlet that is properly installed and grounded in accordance with all local codes and ordinances.

Danger

Improper connection of the equipment-grounding conductor can result in a risk of electric shock. Check with a qualified electrician or service person if you are in doubt as to whether the treadmill is properly grounded. Do not modify the plug provided with the treadmill—if it doesn't fit the outlet; get a proper outlet installed by a qualified technician.

The treadmill is for use on a nominal 120-volt circuit and has a grounding plug that looks like the plug illustrated in the "Grounding Instructions" section of this book.

Warning

This product is rated for use on a circuit having a nominal rating of 120 volts, 15 amps and is factory-equipped with a specific electric cord and plug to permit connection to a proper electric circuit. Make sure that the product is connected to an outlet having the same configuration as the plug. No adapter should be used with this product. If the treadmill must be reconnected for use on a different type of electric circuit, the reconnection should be made by qualified service personnel.

FCC WARNING - POSSIBLE RADIO/TELEVISION INTERFERENCE

NOTE: This equipment has been tested and found to comply with Part 15 of the FCC rules. These limits are designed to provide reasonable protection against harmful interference in a residential installation. Any changes or modifications not expressly approved by the party responsible for the compliance could void the user's authority to operate the equipment. This equipment generates, uses and can radiate radio frequency energy and, if not installed and used in accordance with the instructions, may cause harmful interference to radio communications. However, there is no guarantee that the interference will not occur in a particular installation. If this equipment does cause harmful radio interference to radio or television reception, which can be determined by turning the equipment off and on, you are encouraged to try to correct the interference by one or more of the following measures:

Class R (Residential): Private or non-commercial use

- Reorient or relocate the receiving antenna
- Increase space between the equipment
- Plug the equipment into two electrical outlet located on separate circuits
- Consult an exercise equipment dealer or an experienced radio/TV technician for help

The Proper Outlet

This product must be grounded. A temporary adapter such as the one illustrated below may be used to connect this plug to a 2-pole receptacle as shown, if a properly grounded outlet is not available. If it should malfunction or breakdown, grounding provides a path of least resistance for electric current to reduce the risk of electric shock. This product is equipped with a cord having an equipment-grounding conductor and grounding plug. The plug must be plugged into an appropriate outlet that is properly installed and grounded in accordance with all local codes and ordinances.

DANGER- Improper connection of the equipment-grounding conductor can result in a risk of electric shock. Check with qualified electrician or serviceman if you are in doubt as to whether the product is properly grounded. Do not modify the plug provided with the product - if it will not fit the outlet, have a proper outlet installed by a qualified electrician. This product is for use on a nominal 120-volt circuit and has a grounding plug that looks like the plug illustrated in the figure. Make sure that the product is connected to an outlet having the same configuration as the plug. No adapter should be used with this product. It is recommended to use a 15 amp dedicated circuit.

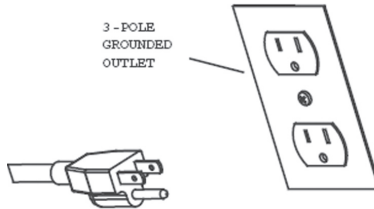

- The appliance must be positioned so that the plug is accessible
- If the power cord is damaged, it must be replaced by the manufacture or its service agent or a similarly qualified person in order to avoid a hazard.

Table of Contents

Safety Guidelines.....	1-5
Introduction.....	7
Hardware and Components Chart.....	8-9
T6iHRC Assembly Diagram.....	10
Assembly Steps.....	11
Belt Tension.....	12-14
Adjustments.....	15
The Console and Controls.....	16-18
Working Out.....	18-23
Stretching and Flexibility.....	24-26
Maintenance And Lubrication.....	27-28
Warranty.....	29
Endurance Customer Service Information.....	30

Introduction

Congratulations on purchasing an Endurance treadmill. Your journey to a better body and a healthier lifestyle is about to begin. We hope this treadmill will be an integral part of your home fitness program.

Be sure to read and understand this owner's manual prior to assembly and use of your treadmill. Understanding the correct assembly, adjustments, maintenance and operation of this machine will enhance your ability to achieve your fitness goals safely and successfully.

The image below details the various components of your new Endurance treadmill:

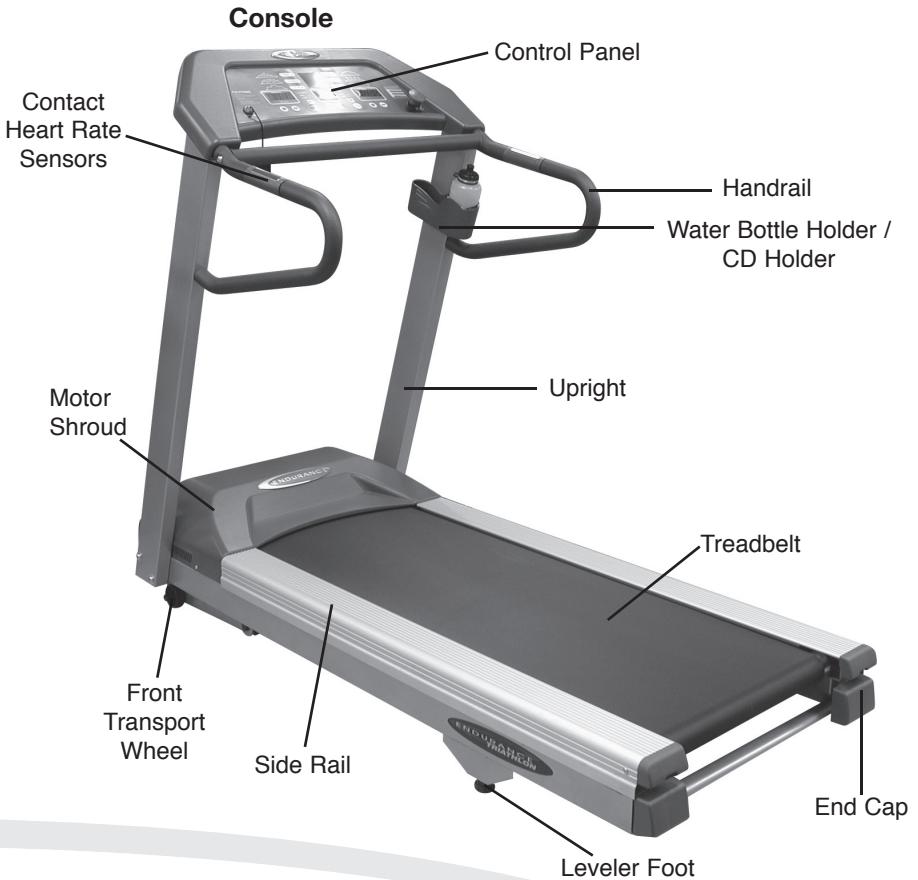

Assembly Components Meijer.com

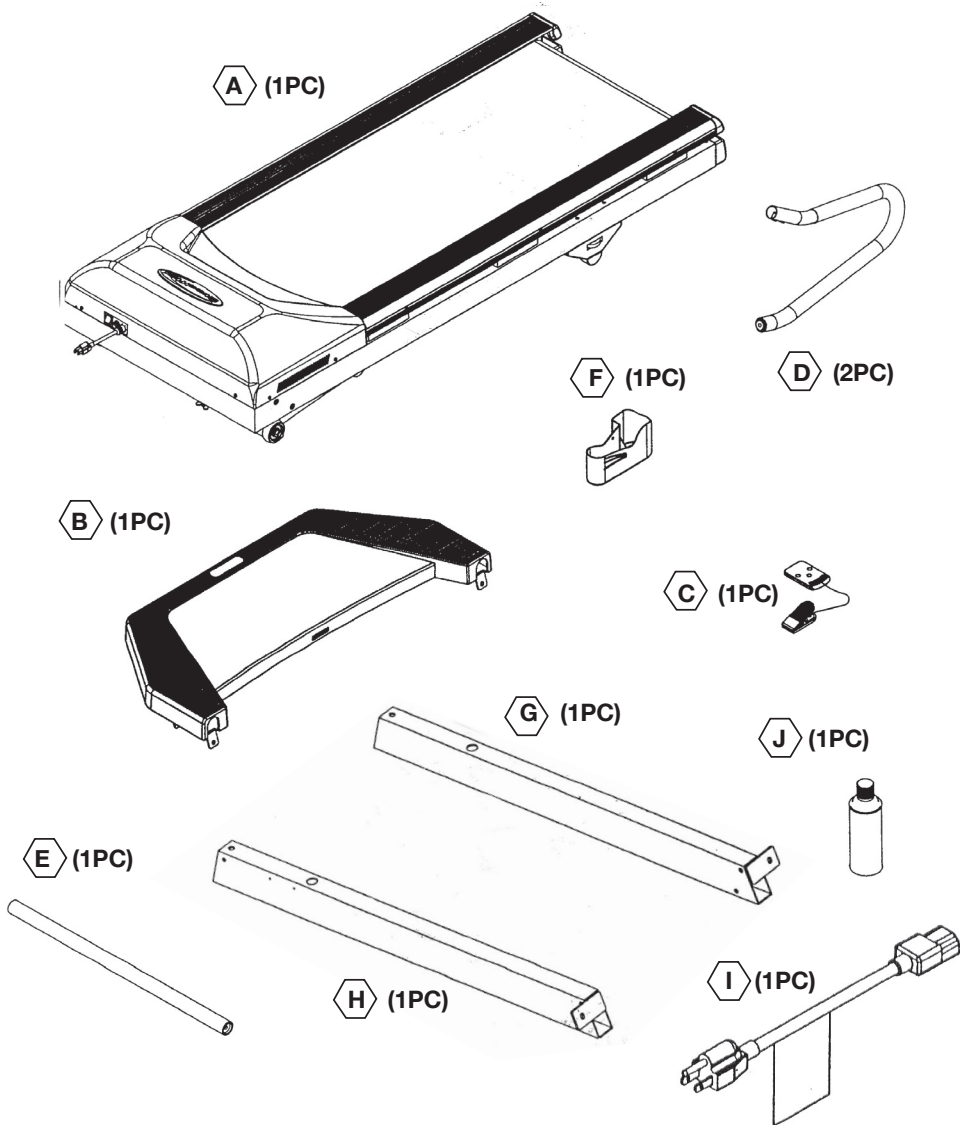

Hardware Diagram

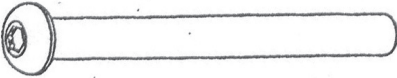

Round Inner Hex Screw 10mm x 100mm Part #  A1 QTY. 4

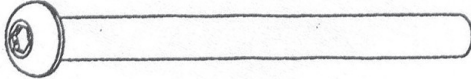

Round Inner Hex Screw 10mm x 120mm Part #  A2 QTY. 2

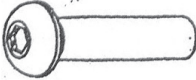

Round Inner Hex Screw 10mm x 50mm Part #  A3 QTY. 2

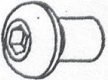

Round Inner Hex Screw 10mm x 15mm Part #  A4 QTY. 6

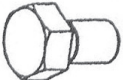

Hex Head Bolt 10mm x 15mm Part #  A5 QTY. 2



Round Cross Screw 4mm x 15mm Part #  A6 QTY. 2

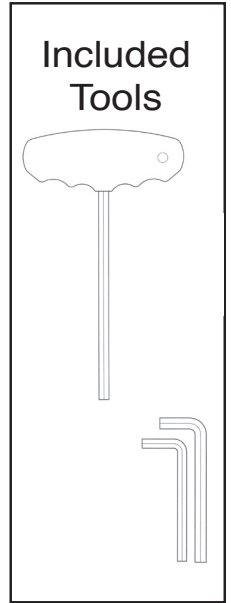

Flat Washer 10mm
Part #  C1 QTY. 10



Flat Washer 4mm
Part #  C2 QTY. 2

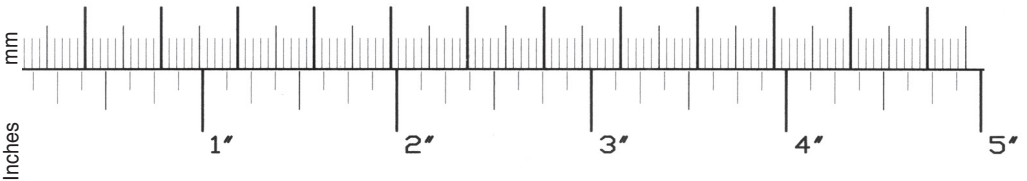

Inches

1"

2"

3"

4"

5"

Assembly Diagram

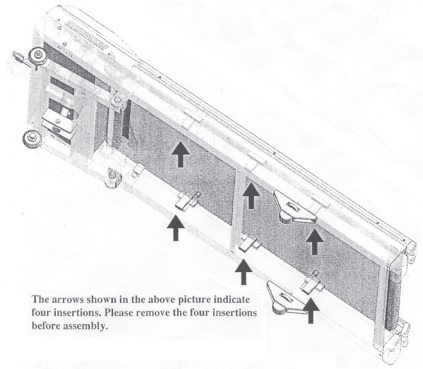
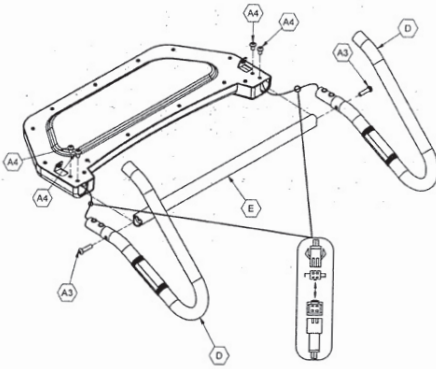

Do not tighten the bolts down completely during first assembly. After the completion of step 3, then you may tighten the bolts completely.

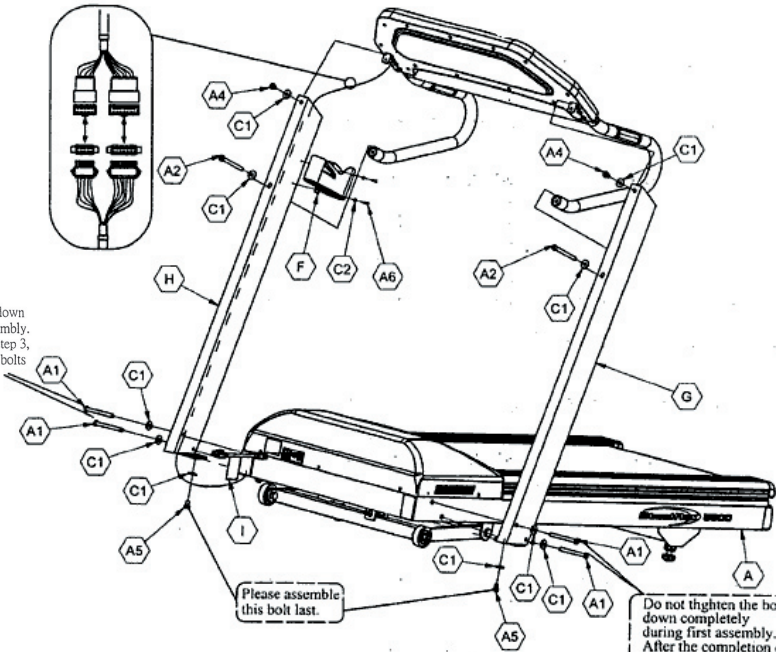

Do not tighten the bolts down completely during first assembly. After the completion of step 3, then you may tighten the bolts completely.

Assembly

Please Note: We recommend that you have a person assist you with the assembly of your new treadmill. Use caution during the assembly of this product.

Step 1:

Align the vertical support frame (C) to the bottom base of the treadmill deck (A). Then attach (C) to (A) using two (A-1) – set screws and two (C-2) & (C-3) – washers. Attach (G) & (F) to (H) using 2 (A4) bolts. Then attach 2(F) to (H) using 4(A3) bolts. **Note: Do not attach (A3) bolts until after step 3.**

Step 2:

A) Locate the silver feeding line attached to the inside of (D) and find the control wire attached to (A). Carefully hook the silver feeding line around the control wire harness at the bottom base of the treadmill deck (A). Feed the silver feeding line and the control wire harness into the bottom of the vertical support frame (D) and all the way through the top. As shown in (Fig 1).

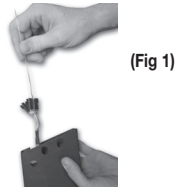

B) Once the Wire Harness has completely passed through the vertical support frame, attach the vertical support frame (D) to the bottom portion of the deck (A) using two (A-1) – bolts and two (C-3) – washers.
C) Attach (E) to (C) & (D) using 2 (A3) & 2 (C1).

ATTENTION: Do not fully tighten these set screws until entire unit is assembled.

Step 3:

A) Connect the Wire Harness to Console Wire Harness (See Fig 2).
B) Carefully align the Console (H) with the vertical support frames (D) & (C). Once aligned, secure the console (H) with 4 (A-3) & 2 (A-2) bolts and 6 (C-1) washers.
C) Next, insert two (A-3) set screws at the bottom of the vertical support frames and then proceed to tighten the rest of the unit.

ATTENTION: When attaching the vertical support frame (D) to the treadmill deck (A) and then to the console (H) be sure not to crimp or sever the Control Wire. Severing these wires can cause the treadmill to short out.

D) Finally, attach the sports bottle holder (I) by using two (A-6) Phillips screws & 2 (C-2) Washers.

Belt Tension and Centering Set Up

Initial Adjustment

After assembly and before turning power on position the rear roller using the "T" wrench (refer to the drawing if needed). Make 3 turns clockwise to avoid the belt from slipping.

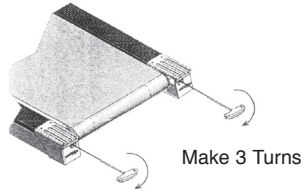

If belt is too far to the left side:

- 1) Turn the left roller bolt 1/4 turn clockwise (tighten)
- 2) Turn the right roller 1/4 turn counterclockwise (loosen)

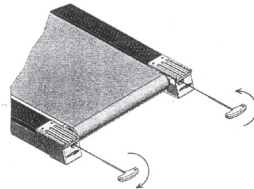

If belt is too far to the right side:

- 1) Turn the right roller bolt 1/4 turn clockwise (tighten)
- 2) Turn the left roller bolt 1/4 turn counterclockwise (loosen)

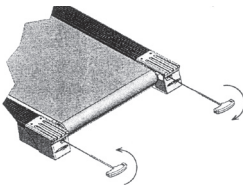

A) TENSIONING THE BELT

If you can feel a slipping sensation when you plant your foot on the belt, the belt is slipping over the roller. This is normal and a common adjustment on a treadmill. To eliminate slipping, tighten both sides of the rear roller. Using an Allen wrench, tighten the roller tension bolts (located at the end caps) 1/4 of a turn clockwise as shown below. Try the treadmill again to check for slipping. Repeat if necessary, but NEVER TURN the roller bolt more than 1/4 turn at a time.

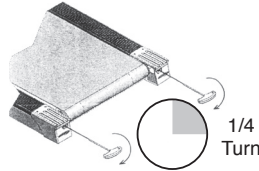

CAUTION:

OVER TIGHTENING OF THE ROLLER WILL SEVERELY SHORTEN THE LIFE OF THE BELT AND MAY CAUSE FURTHER DAMAGE TO OTHER COMPONENTS.

NOTE:

If you have tightened the running belt and are still experiencing a slipping sensation, call your Endurance dealer for service.

B) CENTERING THE BELT

If belt is too far to the left side:

- 1) Turn the left roller bolt 1/4 turn clockwise (tighten)
- 2) Turn the right roller 1/4 turn counterclockwise (loosen)

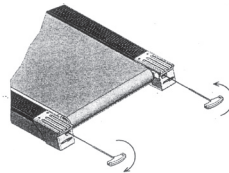

If belt is too far to the right side:

- 1) Turn the right roller bolt 1/4 turn clockwise (tighten)
- 2) Turn the left roller bolt 1/4 turn counterclockwise (loosen)

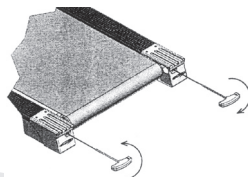

C) BELT MAINTENANCE

Inspect the Running belt monthly to check its condition. Look for loose pieces, tears or extremely worn areas. If these conditions occur, replace the running belt immediately. Please call Endurance Customer Support.

Proper Use

- **DO NOT** use this product unless proper attire is worn. Rubber-soled training, running, or tennis shoes must be worn to provide proper traction and protection while using this product.
- **DO NOT** use cleats, spikes or any other non-athletic style shoes.
- **DO NOT** use this product while barefoot or wearing only socks.

INSTALLATION REQUIREMENTS

A) Electrical Requirements

Your Endurance™ treadmill is intended for use in the country to which it was shipped. Electrical supplies outside of this country may differ and may not be compatible with the product. Please consult Customer Support before using the treadmill in a different country.

B) Space Requirements

When choosing a location for the treadmill, pick a location that is unobstructed. The treadmill must have the following clearance. These spacing requirements are mandatory for the safe use of the treadmill. If an accident should occur, you must have sufficient space to move away from the treadmill.

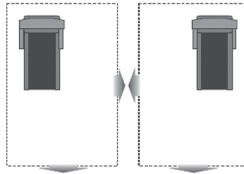

- Non-entry side of treadmill - Minimum of 8 inches (20cm)
- Entry side of treadmill - Minimum of 36" (90cm)
- Front of the treadmill - Minimum of 12 inches (30cm)
- Behind treadmill - Minimum of 6 feet (180cm)

Leveling The Treadmill

Leveler Legs

After finding a location that is suitable for the treadmill, the rear legs may need to be adjusted to provide stable support. Turn the adjustment knob clockwise to raise the height (Fig. 1).



Fig. 1

WARNING:

DO NOT adjust legs while the treadmill is on. Turn the power switch to the OFF position.

While kneeling behind the treadmill, place the heel of your hands on each side of the treadmill directly above the running-belt adjustment bolts. Attempt to rock the treadmill by alternately pressing downward on each side. If you feel even a slight movement on one side adjust that side until the movement has stopped.

For example, if you feel a slight rocking on the right side, start by turning the thumb-wheel on the right leg counter-clockwise to lower the leg until the movement stops.

Treadmill Overview

POWER SWITCH

The power switch is located in the front of the treadmill near the power cord. The power switch has two positions - ON and OFF. The display console will beep when the treadmill is plugged in and the power switch is pressed ON.

CIRCUIT BREAKER RESET

The circuit breaker is located next to the power switch. If there should be an electrical overload due to a surge in electricity or other situation, the circuit breaker will disconnect and attempt to prevent any damage from occurring to the treadmill. If the treadmill suddenly stops with no lights visible nor beep heard, the circuit breaker may need to be reset. To reset the circuit breaker press the button firmly. The display console should restart and a beep should be heard.

ON / OFF
Switch

Circuit
Breaker
Reset

Power
Cord



POWER CORD

The power cord, located in the front of the treadmill must be plugged into a properly grounded electrical outlet. Locate the power cord so it will not come in contact with the wheels of the treadmill during operation. This may cause the power cord to become pinched or damaged. Damage to the power cord could result in a fire hazard or cause personal injury through electrical shock.

CAUTION:

Feel the power cord with your hands. If the power cord is warm to the touch a problem may exist with the electrical outlet in which the treadmill is plugged. It may be necessary to plug the treadmill into a different outlet.

Control Panel Instructions

GETTING STARTED

After the treadmill is correctly installed and plugged in, it's time to start our workout. Begin by pressing the power switch, located in the front of the treadmill near the power cord, to the **ON** position.

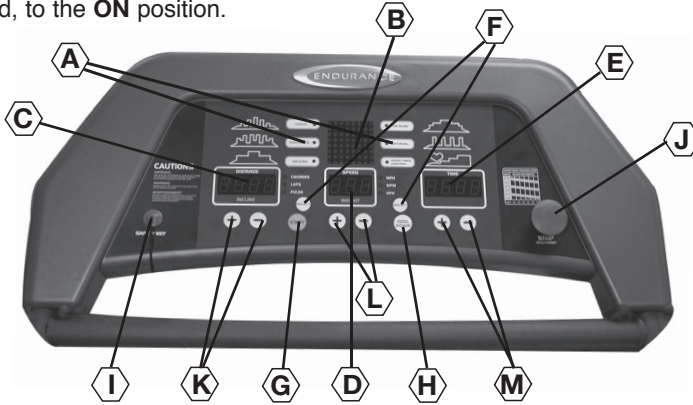

- A. Program Buttons**
- B. Course Profile Matrix**
- C. Distance / Incline / Calorie / Lap / Heart Rate Display**
- D. Speed Display**
- E. Time Display**
- F. Select Buttons**
- G. Start Button**
- H. Cool Down Button**
- I. Safety Key**
- J. Stop Button**
- K. Incline + - Buttons**
- L. Speed + - Buttons**
- M. Time + - Buttons**

Program Indicators

LED lights to indicate current program. Press the button for the desired program, after you have entered your weight.

Course Profile Matrix

Displays the hills and valleys of your chosen fitness course or current lap.

Distance / Incline / Calorie / Lap / Heart Rate Display

Displays the deck's incline percentage as your workout progresses, the distance you have run, the amount of calories you have burned, which lap you are on, and your current heart rate. The window will default to the distance display. When the incline arrows are pressed, then the display will show the current incline. You can change the incline % at any time by pressing the up/down arrows under the readout window. To display calories, lap, or heart rate, press the **Select** button. The LED light next to each category on the control panel signifies which information is currently displayed after pressing select, if none of the LED lights are lit, then distance is displayed. You can cycle through the information by pressing the **Select** button until the information you want is displayed.

Speed Display

The Speed window displays the current belt-speed setting. The Speed + and Speed - Arrow buttons are located below the Speed window and are used to increase or decrease the belt-speed during a workout. Speed readouts are available in miles per hour, miles per minute, and kilometers per hour. The LED light next to each category on the control panel signifies which information is currently displayed, to change the display press the **Select** button.

Time Display

This window displays the elapsed time of your current workout. The Time Arrow buttons can be used to change the time of a workout.

Select Button

The select button on the left side will allow you to choose distance, calorie, lap, or heart rate for display in the **Distance / Incline / Calorie / Lap / Heart Rate Display**. The **select** button on the right side will allow you to choose the speed readout in miles per hour, miles per minute, and kilometers per hour.

Start Button

Located in the left center of the Display Console the Start button is used to begin a workout after all of the prompted information has been entered. To start a simple, manual program in ascending time, press the Start button and the tread belt will start to move after a 3 second countdown.

Cool Down Button

Pressing the Cool Down button will slowly reduce your speed to 0. Using the Cool Down feature will safely slow your heart rate, reduce your body temperature and reduce the chance of cramping. Speed reduction rate can be expected as follows:

- 10 mph – 0 mph / 120 seconds
- 7 mph – 0 mph / 90 seconds
- 5 mph – 0 mph / 60 seconds
- 3 mph – 0 mph / 30 seconds

Safety Key

Safety Key quickly stops the treadmill when disconnected from the control panel in the event of an emergency. The Safety Key, when used correctly, will pull out of the Console and stop the treadmill quickly if the user has fallen or is out of the safe operating area. For hands-free safety, simply attach the clip end of the Safety Key to a non-obstructive area of your clothing. The treadmill will not operate unless the Safety Key is in position. To prevent children or unauthorized users from using your treadmill, we recommend that you store the Safety Key off the console.

Stop Button

The over-sized Stop Button is located on the right of the console. Press the Stop Button and release to pause your workout. Your progress and feedback information will remain on display and the tread belt will slow to a halt. To resume your workout, press Start and the treadmill will resume where you left off after a 3-second countdown. Holding the Stop Button down for 3 seconds will completely reset the control panel.

Working Out On Your Endurance Treadmill

Before You Start:

Your new Endurance treadmill will help you enjoy a healthier lifestyle if used properly. Be sure to completely read and understand this user guide before you begin your exercise regimen.

- At the beginning of a workout, take several minutes at a moderate pace to bring your heart rate into your training zone.
- After your workout, walk slowly for several minutes to cool down your body and lower your heart rate. Use a slow speed setting for several minutes on your treadmill.
- Before and after a workout, gently stretch to help prevent stiffness or soreness.

CAUTION:

DO NOT OVER-INCREASE SPEED! As the **Speed + Button** is pressed, the Belt-speedvalue shown in the Speed window will increase immediately. The running belt will increase to this speed gradually. If a speed value is entered that is too high for the user's capabilities, personal injury may occur.

DO NOT CONTINUALLY PRESS THE SPEED + BUTTON TO INCREASE THE BELT SPEED. Enter a known, comfortable value and wait for the running belt to reach that speed. Use care when further increasing the speed.

A variety of exercise options are available on your Endurance treadmill. Refer to the course profiles printed on the electronic console. Detailed descriptions on these fitness programs are on the following pages.

Adjustments On-The-Fly:

Stop Button-

Pause your workout if necessary by pressing the **Stop Button** once. Simply hit **Start** to resume your workout. Holding the **Stop Button** down for 3 seconds will reset the control panel.

Speed + – Buttons -

Adjust Speed or Elevation by increasing or decreasing the display value.

Select Button –

The **Select Button** on the left side will allow you to choose distance, calorie, lap, or heart rate for display in the **Distance / Incline / Calorie / Lap / Heart Rate Display**. The **Select Button** on the right side will allow you to choose the speed readout in miles per hour, miles per minute, and kilometers per hour.

Working Out With Programs

Enter User Weight

When your treadmill is first turned on, press any button besides **Start** and the **Speed Display** will display a weight of 200 lbs. At this point, adjust to your weight using the any of the + - buttons.

Manual

Manual Ascending Time (Count Up Mode)

To begin in Manual Mode, enter your user weight, next step onto the side rails of the treadmill deck and press **Start**. Once the tread belt begins to move, hold on to the handrails and step on to the tread belt. Once you are accustomed to the speed of the belt, you can let go of the handrails. You can now adjust the speed and elevation levels to best suit your workout.

Manual Set Time Goal (Count Down Mode)

To use the Manual program with a time goal, first enter your user weight and wait for the **Time Display** to flash 00:00. To change the time of the workout, press the **Time + - Buttons** to adjust the time from 5:00 to 99:00. When you have set your preferred workout time, press **Start**. Once the tread belt begins to move, hold on to the handrails and step on to the tread belt. Once you are accustomed to the speed of the belt, you can let go of the handrails. You can now adjust the speed and elevation levels to best suit your workout.

Fitness Programs

Your Endurance treadmill features fitness programs designed to help you achieve different goals. To further compliment your workout, these programs feature 3 user levels at progressive degrees of intensity.

Cardio

The first step to a healthier heart! The Cardio workout profile is designed to raise your heart rate to a higher level – effectively helping your entire cardiovascular system to become stronger.

Step 1 – Choose your program

Step onto the side rails of the treadmill deck and enter your weight. Next, press the **Cardio Program button**, the LED light will light up and the **Speed Display** will show L1 for user level 1, and the **Time Display** will show 24:00. If intensity level 1 is the level you desire, with a workout time of 24:00, then press **Start**.

Step 2 – Adjusting the User Level

To adjust the User Level to Level 2 or Level 3, follow the same procedure as written in Step 1 until the **Speed Display** shows L1 and the **Time Display** will show 24:00, then use the **Speed + - buttons** to adjust to the desired level (from Level 1 to Level 2 or 3, and the **Course Profile Matrix** will display the adjusted workout profile). Once you have selected your user level, press **Start** if a 24:00 workout is desired, to change the workout time go to **Step 3**.

Step 3 – Adjusting the Workout Time

To adjust the workout time, follow the same procedure as written in Step 1 and Step 2 until the **Speed Display** shows the appropriate user level and the **Time Display** will show 24:00, then use the **Time + -** buttons to adjust to the desired workout time from 5:00 – 99:00 minutes. Once you have selected the desired workout time, press **Start**. Once the tread belt begins to move, hold on to the handrails and step on to the tread belt. Once you are accustomed to the speed of the belt, you can let go of the handrails.

Endurance

Build your endurance and feel the burn. Training for increased endurance fights fatigue in your daily routines, improve your mood and will have you looking as good as you feel.

Step 1 – Choose your program

Step onto the side rails of the treadmill deck and enter your weight. Next, press the **Endurance Program button**, the LED light will light up and the **Speed Display** will show L1 for user level 1, and the **Time Display** will show 40:00. If intensity level 1 is the level you desire, with a workout time of 40:00, then press **Start**.

Step 2 – Adjusting the User Level

To adjust the User Level to Level 2 or Level 3, follow the same procedure as written in Step 1 until the **Speed Display** shows L1 and the **Time Display** will show 40:00, then use the **Speed + -** buttons to adjust to the desired level (from Level 1 to Level 2 or 3, and the **Course Profile Matrix** will display the adjusted workout profile). Once you have selected your user level, press **Start** if a 40:00 workout is desired, to change the workout time go to **Step 3**.

Step 3 – Adjusting the Workout Time

To adjust the workout time, follow the same procedure as written in Step 1 and Step 2 until the **Speed Display** shows the appropriate user level and the **Time Display** will show 40:00, then use the **Time + -** buttons to adjust to the desired workout time from 5:00 – 99:00 minutes. Once you have selected the desired workout time, press **Start**. Once the tread belt begins to move, hold on to the handrails and step on to the tread belt. Once you are accustomed to the speed of the belt, you can let go of the handrails.

Walking

Designed for workouts at lower intensity levels, mild elevation changes simulate walking outside. A great workout for beginners or when you need a lighter workout.

Step 1 – Choose your program

Step onto the side rails of the treadmill deck and enter your weight. Next, press the **Walking Program button**, the LED light will light up and the **Speed Display** will show L1 for user level 1, and the **Time Display** will show 32:00. If intensity level 1 is the level you desire, with a workout time of 32:00, then press **Start**.

Step 2 – Adjusting the User Level

To adjust the User Level to Level 2 or Level 3, follow the same procedure as written in Step 1 until the **Speed Display** shows L1 and the **Time Display** will show 32:00, then use the **Speed + -** buttons to adjust to the desired level (from Level 1 to Level 2 or 3, and the **Course Profile Matrix** will display the adjusted workout profile). Once you have selected your user level, press **Start** if a 32:00 workout is desired, to change the workout time go to **Step 3**.

Step 3 – Adjusting the Workout Time

To adjust the workout time, follow the same procedure as written in Step 1 and Step 2 until the **Speed Display** shows the appropriate user level and the **Time Display** will show 32:00, then use the **Time + -** buttons to adjust to the desired workout time from 5:00 – 99:00 minutes. Once you have selected the desired workout time, press **Start**. Once the tread belt begins to move, hold on to the handrails and step on to the tread belt. Once you are accustomed to the speed of the belt, you can let go of the handrails.

Fat Burn

This program was developed to help you melt inches off your waist line for a fitter, trimmer physique.

Step 1 – Choose your program

Step onto the side rails of the treadmill deck and enter your weight. Next, press the **Fat Burn Program button**, the LED light will light up and the **Speed Display** will show L1 for user level 1, and the **Time Display** will show 40:00. If intensity level 1 is the level you desire, with a workout time of 40:00, then press **Start**.

Step 2 – Adjusting the User Level

To adjust the User Level to Level 2 or Level 3, follow the same procedure as written in Step 1 until the **Speed Display** shows L1 and the **Time Display** will show 40:00, then use the **Speed + -** buttons to adjust to the desired level (from Level 1 to Level 2 or 3, and the **Course Profile Matrix** will display the adjusted workout profile). Once you have selected your user level, press **Start** if a 40:00 workout is desired, to change the workout time go to **Step 3**.

Step 3 – Adjusting the Workout Time

To adjust the workout time, follow the same procedure as written in Step 1 and Step 2 until the **Speed Display** shows the appropriate user level and the **Time Display** will show 40:00, then use the **Time + -** buttons to adjust to the desired workout time from 5:00 – 99:00 minutes. Once you have selected the desired workout time, press **Start**. Once the tread belt begins to move, hold on to the handrails and step on to the tread belt. Once you are accustomed to the speed of the belt, you can let go of the handrails.

Interval

Interval Training is a great way to eliminate frustrating fitness plateaus. It combines aspects of endurance training and cardio training with various inclines and speeds.

Step 1 – Choose your program

Step onto the side rails of the treadmill deck and enter your weight. Next, press the **Interval Program button**, the LED light will light up and the **Speed Display** will show L1 for user level 1, and the **Time Display** will show 32:00. If intensity level 1 is the level you desire, with a workout time of 32:00, then press **Start**.

Step 2 – Adjusting the User Level

To adjust the User Level to Level 2 or Level 3, follow the same procedure as written in Step 1 until the **Speed Display** shows L1 and the **Time Display** will show 32:00, then use the **Speed + -** buttons to adjust to the desired level (from Level 1 to Level 2 or 3, and the **Course Profile Matrix** will display the adjusted workout profile). Once you have selected your user level, press **Start** if a 32:00 workout is desired, to change the workout time go to **Step 3**.

Step 3 – Adjusting the Workout Time

To adjust the workout time, follow the same procedure as written in Step 1 and Step 2 until the **Speed Display** shows the appropriate user level and the **Time Display** will show 32:00, then use the **Time + -** buttons to adjust to the desired workout time from 5:00 – 99:00 minutes. Once you have selected the desired workout time, press **Start**. Once the tread belt begins to move, hold on to the handrails and step on to the tread belt. Once you are accustomed to the speed of the belt, you can let go of the handrails.

Heart Rate Control

Maximize your results with the Heart Rate Control program. Exercise smarter and get more benefits with less training when using this program. The Heart Rate Control program will monitor your heart rate and automatically adjust to maintain your target heart rate. It is like having a your own personal trainer.

Note: An Endurance chest strap or Polar TM compatible strap is required to use the Heart Rate Control program. Also a warm up is required before starting the Heart Rate Control program. Usually a warm up period of 5 –10 minutes is sufficient (a good rule of thumb is to break a sweat), then continue with the following steps.

Step 1

After your warm up, step onto the side rails of the treadmill deck and press and hold **Stop** until the treadmill resets. Next, enter your weight, then press **Start**. Next, press the **Heart Rate Control Program** button and the LED light will light up. The **Course Profile Matrix** will show a heart. Press **Start** again, and the speed display will show 120 which stands for your heart rate in beats per minute. You can now use the Speed Arrow buttons to adjust this number to your optimal beats per minute for your workout. For a fat burning workout it is recommended to work out between 60% and 70% of your theoretical maximum heart rate. For a cardio workout it is recommended to work out between 70% and 85% of your theoretical maximum heart rate. Use the formulas below to calculate your optimal beats per minute to enter based on your goals.

Fat Burning Workout

Low End (Beats per minute) = $(220 - \text{age}) \times 60\%$

High End (Beats per minute) = $(220 - \text{age}) \times 70\%$

Cardio Training Workout

Low End (Beats per minute) = $(220 - \text{age}) \times 70\%$

High End (Beats per minute) = $(220 - \text{age}) \times 85\%$

For example, a 45 year old woman who would like to perform a fat burning workout at 65% of her theoretical maximum would use;

$$(220-45) \times .65 = 114 \text{ beats per minute}$$

The same woman for a cardio workout at 80% of her theoretical maximum is calculated;

$$(220-45) \times .80 = 140 \text{ beats per minute}$$

Once you have adjusted to the desired beats per minute with the Speed Arrow buttons, press the **Start** button to begin your workout, and the treadmill will adjust speed to keep you at your target rate.

Stretching / Flexibility

Adequate flexibility is the ability to move your limbs and joints easily (through a complete range of motion) the way you need to in order to meet the challenges of daily life. Fortunately there's a positive reinforcing cycle between flexibility and activity. Adequate flexibility enables you to maintain an active lifestyle, and an active lifestyle makes an important contribution to maintaining adequate flexibility. These relationships grow stronger the older we become.

When should I stretch?

Any time is a good time to Stretch. In the morning it can work out the kinks in your back, at work, you can relax your neck and shoulders, and after work stretch out your lower back. However, you should never do your stretches before you have had a chance to warm your body up.

How should I stretch?

Perform the following stretches slowly and smoothly until you feel a slight "tugging" sensation on the muscles involved. Don't stretch to the point that you feel pain, and don't bounce or you could pull a muscle. Hold each stretch for 10 to 20 seconds. Exhale through the stretch, and breathe slowly. This will keep you from bouncing.

Calf (back of lower leg)

1. Straight knee start with the leg to be stretched approximately three feet from the wall and the opposite leg on step forward. Lean toward the wall, keeping your heels down and feet turned in slightly.
2. Bent knee start same as above, but move approximately one foot closer to the wall and bend the knee of the back leg to be stretched.
3. Repeat using the other leg.

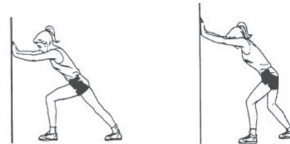

Iliotibial Band (outside of hip)

1. Start with the leg to be stretched one step back and behind the opposite foot. Move your hips sideways toward the side of your body being stretched. Keep the upper body away from the wall and do not bend forward.
2. Repeat using the other leg.



Lower Back, Hips, Groin, and Hamstrings

1. Stand with the feet about shoulder-width apart and pointed straight ahead. If you are pretty flexible and need more of a stretch, cross one leg in front of the other for a few stretches, then switch legs.
2. Slowly bend forward from the hips, always keeping your knees slightly bent.
3. Stretch only to the point where you feel a tugging in the back of your legs.



Side Bends

1. Stand with your feet about shoulder-width apart and toes pointed straight ahead. Keep your knees slightly bent, one hand on your hip; extend your other arm up and over your head. Slowly bend at your waist to one side, toward the hand on your hip.
2. Extend both arms overhead. Hold your right hand with your left hand and bend slowly to the left, using your left arm to pull the right arm gently over the head and down toward the ground.
3. Repeat with other side.

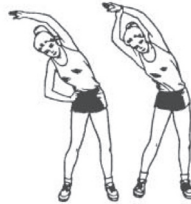

Quadriceps (front of thigh)

1. Lying on our stomach, pull the heel toward your buttocks with the opposite hand. Keep the thigh of the leg being stretched close to the leg on the floor.
2. The same stretch can be done standing. Do not allow the thigh to come in front of you and do not bend forward at the waist.
3. Do this exercise twice – once on each leg.

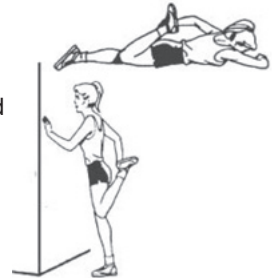

Groin (inside of thigh)

1. Sit on the floor with the soles of your feet together. Gently push knees down toward the floor with your elbows.
2. Stand with your feet three to four feet apart and turned out slightly.
3. Keep the knee of the leg to be stretched straight, and bend the opposite knee as you move your body toward the bent leg. Keep your toes pointed forward.
4. Repeat using the other leg

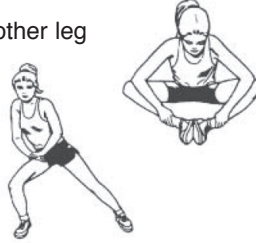
**Hamstrings (back side of upper leg)**

1. Sit with one knee bent and the leg to be stretched out straight. Reach for the toes of the straight leg with the right hand and then the left hand.
2. Repeat with the other leg.

**Gluteus (back of hip)**

1. Lie on your back. Pull one knee up to your chest while keeping the opposite leg down on the floor with the knee straight.
2. The same may be done standing.
3. Repeat with the other leg.

**Anterior Tibialis (front of shin)**

1. Stand with all of your weight on one leg. Extend the opposite leg forward and flex and point at the ankle.
2. Repeat with the other leg.

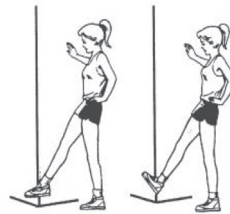

Maintenance

Here are some preventative maintenance tips that will keep your treadmill operating at its best.

Cleaning

When cleaning the exterior of the unit, a non-abrasive cleanser and soft cotton cloth are strongly recommended. At no time should cleanser be applied directly to any part of the equipment. Instead, place the non-abrasive cleaning solution on a soft cloth and wipe down the unit.

- Clean the Display Console and all exterior surfaces regularly.
- Vacuum running belt regularly to keep debris from accumulating.
- Inspect exterior parts regularly for wear and tear, especially the running belt and deck.
- Inspect area under treadmill and vacuum regularly.

Recommended Maintenance

Item	Daily	Weekly	Monthly	Quarterly	Bi-annual
Console Mounting Bolts					Inspect
Frame	Clean				Inspect
Display Console	Clean		Inspect		
Emergency Button	Test				
Power Cord			Inspect		
Running Belt Top		Clean (Vacuum)			
Running Belt Tension			Inspect		
Running Deck Lubrication				Inspect	
Anti-Shock Strip					Inspect
Rear Adjustable Foot				Adjust	
Control Room			Clean (Vacuum)		
V Belt				Adjust	Inspect
Motor Pulley				Clean	
Motor Carbon Brush				Inspect	

Lubricating the Running Belt and Deck

Your running deck features a phenolic surface which reduces friction. Use the included **Treadmill Silicone Lubricant Spray (H)** (see **Treadmill Hardware and Components Page at the front of the book**) for optimum performance and extended deck and belt life.

To lubricate your deck:

- 1) Insert the tube into the spray tip. **NEVER POINT THE SPRAY TIP OR SPRAY TUBE TOWARD YOUR FACE.**
- 2) Make sure the treadmill is OFF and unplugged from the power source.
- 3) Pull up lightly on the tread belt and spray lubricant as evenly as possible between the underside of the tread belt and the top of the deck. As you use your treadmill, the lubricant will spread and even out – protecting your deck and belt.
- 4) Store silicone lubricant in a safe place and out of the reach of children.

Warning

- 1) Do not spray lubricant on the top side of the tread belt. The running surface must retain traction.
- 2) Inspect tread belt for overspray before use.
- 3) If you accidentally oversprayed silicone spray on the top side of the treadbelt or the side rails, clean immediately to prevent accidental injury.

IN HOME LIFETIME WARRANTY CONDITIONS

Endurance warrants all treadmills as follows:

Treadmill Frame	LIFETIME
Treadmill Parts	LIFETIME
Treadmill Electronics	LIFETIME
Treadmill Wear Items	LIFETIME
Labor	1 YEAR

1. This Lifetime Warranty applies only to the original owner and only extends the warranty to cover the cost of parts repair or replacement and does not include freight charges associated there with. Proof of purchase must be demonstrated.
2. Labor is covered for a period of one (1) year from date of sale and is not a part of the Lifetime Warranty.
3. Labor coverage is provided only if the work is done by an authorized Endurance dealer or the Endurance factory.
4. During the labor coverage period, Endurance compensates authorized Endurance dealers for warranty trips within their normal service area to make repairs at the customer's location. You may be charged a travel charge outside the normal service area.
5. This warranty applies to residential use only, and is void if this product is used in a non-residential environment.
6. This warranty does not cover customer instruction, installation, set up, or adjustments. Note that tread belt tensioning and tracking are the responsibility of the user and are not covered by this warranty. User is also responsible for reasonable and necessary maintenance. Reasonable and necessary maintenance includes tread belt tracking and tensioning as well as proper lubrication of the running deck and tread belt area as specified in the owner's manual. Failure to maintain proper tread belt tracking, tensioning, and lubrication of the treadmill deck will void this warranty.
7. This warranty does not cover damage or equipment failure caused by, or resulting from accident, misuse, abuse, improper assembly or installation, non-authorized modification, or failure to provide reasonable and necessary care as outlined in the owner's manual.
8. This warranty will not be extended to any product whose serial number has been removed, altered, or defaced.
9. This warranty does not cover service calls made to instruct owners on how to operate the treadmill or to instruct owners as to proper tread belt tracking and or tensioning.
10. Floor models and demonstration units shall carry a Lifetime Home-Use Warranty on Frame, Parts, Electronics and Wear Items - but will not be covered for any labor charges
11. This warranty is valid only in the United States and Canada.
12. This warranty protection can be obtained by contacting the authorized dealer from whom you purchased this product, or by contacting Endurance directly.

This warranty becomes VALID ONLY if the Lifetime Home-Use Warranty Registration form included in the box is completely filled in, signed by the original purchaser and mailed to Endurance WITHIN 10 DAYS of the purchaser's receipt of the treadmill.

Endurance-Warranty Department

1900 S. Des Plaines Ave.

Forest Park, IL 60130

Phone: 1-800-556-3113

Fax: 1-708-427-3598

service@endurancecardio.com

