

# LE-37E

---

## 3.5 inch Motherboard

### User's Manual

Edition 1.0  
2015/08/04

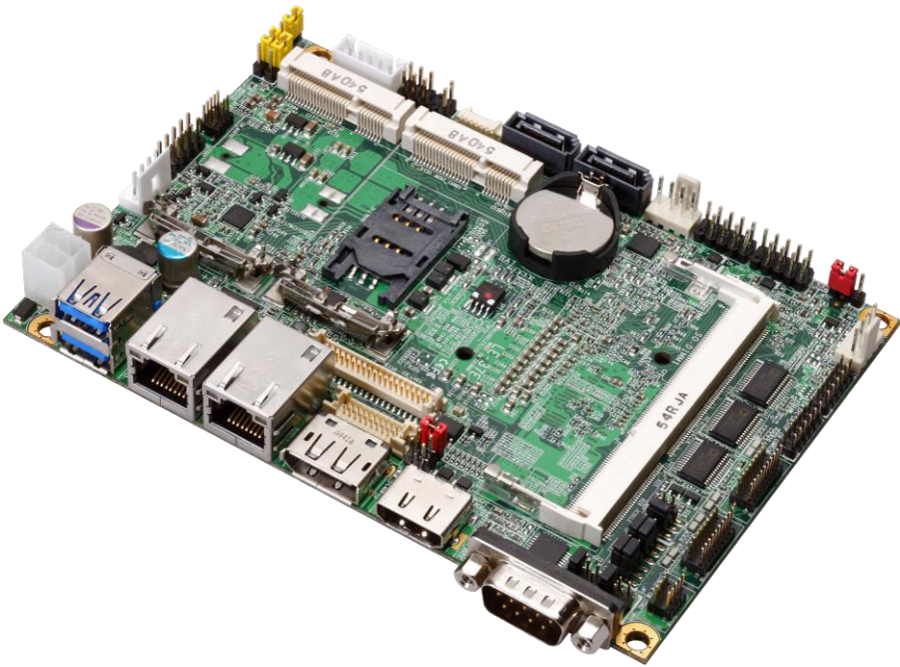

---

## Copyright

Copyright 2015, all rights reserved. This document is copyrighted and all rights are reserved. The information in this document is subject to change without prior notice to make improvements to the products.

This document contains proprietary information and protected by copyright. No part of this document may be reproduced, copied, or translated in any form or any means without prior written permission of the manufacturer.

All trademarks and/or registered trademarks contains in this document are property of their respective owners.

## Disclaimer

The company shall not be liable for any incidental or consequential damages resulting from the performance or use of this product.

The company does not issue a warranty of any kind, express or implied, including without limitation implied warranties of merchantability or fitness for a particular purpose.

The company has the right to revise the manual or include changes in the specifications of the product described within it at any time without notice and without obligation to notify any person of such revision or changes.

## Trademark

All trademarks are the property of their respective holders.

---

Any questions please visit our website at <http://www.commell.com.tw>

## Packing List:

Please check the package content before you starting using the board.



1 x LE-37E 3.5 inch Motherboard  
(include HeatSink)



1 x SATA cable  
(OALSATA3-L / 1040529)



1 xDC Input Power cable  
(OALDC-A / 1040433)



1 x COM Cable  
(OALES-BKU1NB / 1040086)



1 x PS/2 Keyboard & Mouse cable  
(OALPS2/KM / 1040131)



1 x Audio cable  
(OALPJ-HDUNB / 1040123)

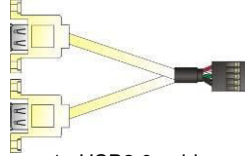

1 xUSB2.0 cable  
(OALUSBA-3 / 1040173)



1 x SATA Power cable  
(OAL4P-S2 / 1040054)

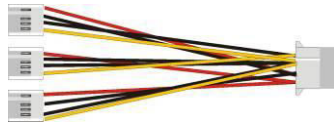

1 x 1 to 3 Power output cable  
(OAL4P-2 / 1040051)

## Optional:

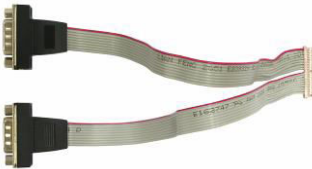

1 x Dual COM cable  
(OALES-BKU2-H14NB / 1040379)



1 x Onboard DVI-D cable  
(BADPDVI\_A & OALDVI-DF13  
/ 4120008021 & 1040483)

---

## Index

<b>Chapter 1 &lt;Introduction&gt;</b> .....	<b>4</b>
1.1 <Product Overview>.....	4
1.2 <Product Specification> .....	5
1.3 <Mechanical Drawing>.....	6
1.4 <Block Diagram>.....	7
<b>Chapter 2 &lt;Hardware setup&gt;</b> .....	<b>8</b>
2.1 <Connector Location and Reference> .....	8
2.1.1 <Internal connectors list> .....	9
2.1.2 <External connectors list> .....	9
2.2 <Jumper Location and Reference>.....	10
2.2.1 <Jumper list> .....	10
2.2.2 <Clear CMOS and Power on type selection> .....	10
2.3 <Installing the Memory>.....	11
2.4 <I/O interface>.....	12
2.4.1 <Serial ATA interface> .....	12
2.4.2 <Ethernet interface> .....	12
2.4.3 <Display interface>.....	13
2.4.4 <Serial Port interface>.....	15
2.4.5 <USB interface> .....	17
2.4.6 <Audio interface> .....	17
2.4.7 <Expansion slot>.....	18
2.4.8 <Front panel switch and indicator> .....	19
2.4.9 <Other interface>.....	19
2.5 <Power supply>.....	21
2.5.1 <Power input> .....	21
2.5.2 <Power output> .....	22
<b>Appendix A &lt;Flash BIOS&gt;</b> .....	<b>23</b>
<b>Appendix B &lt;Installation driver Notes&gt;</b> .....	<b>24</b>
<b>Appendix C &lt;LCD Panel Type select&gt;</b> .....	<b>25</b>
<b>Appendix D &lt;Programmable GPIO &gt;</b> .....	<b>26</b>
<b>Appendix E &lt;Programmable Watch Dog Timer&gt;</b> .....	<b>27</b>
<b>Contact information</b> .....	<b>28</b>

# Chapter 1 <Introduction>

## 1.1 <Product Overview>

LE-37E is 3.5 inch Motherboard which supports 5<sup>th</sup>/4<sup>th</sup> Generation Intel® Core™ U-series i7, i5, i3, Celeron Mobile Processor with Wildcat Point PCH-LP, integrated HD Graphics, DDR3L memory, Realtek High Definition Audio, Intel Gigabit LAN, Serial ATA3 with AHCI function for a system.

### **Intel Broadwell-U Processor with Wildcat Point PCH-LP**

The 5<sup>th</sup> Generation Intel® Core™ U-series processor family is the next generation and compatible with Haswell-U, multi-core mobile processor built on 14/22 nanometer process with MCP technology.

The Broadwell-U has a lower TDP 15W and 28W, it provides new HD Graphics (GT2 and GT3 GPU) support triple display at the same time, maximum supported is up to 16GB of DDR3L, better performance, flexibility and more enhanced security that is suitable for a variety of intelligent systems the ideal choice.

### **All in One multimedia solution**

The board provides high performance onboard graphics, 24-bit dual channel LVDS interface, DisplayPort, HDMI, and High Definition Audio, to meet the very requirement of the multimedia application.

### **Flexible Expansion Interface**

The board provides two MiniPCIe and support mSATA, SIM.

## 1.2 <Product Specification>

### System

Processor	Intel® Broadwell/Haswell Core™ i7, i5, i3, Celeron U-series Processor FCBGA1168 with MCP
Chipset	Wildcat Point-LP
Memory	1 x DDR3L SO-DIMM 1333/1600 MHz up to 8GB Support Non-ECC, unbuffered memory only
Watchdog Timer	Generates a system reset with internal timer for 1min/s ~ 255min/s
Real Time Clock	Chipset integrated RTC with onboard lithium battery
Expansion	2 x MiniPCIe (support mSATA) and Card2 half-size choosable, 1 x SIM slot

### Graphics

Chipset	Intel® 5th/4th Gen integrated HD Graphics
Display Interface	1 x HDMI/DVI-D, 1 x DisplayPort/DVI-D, 1 x LVDS

### LAN

Chip	1 x Intel® I210-AT Gigabit LAN 1 x Intel® I218-LM Gigabit LAN (Support iAMT10.0)
------	---

### I/O

Serial ATA	2 x SATA3 support RAID 0, 1
Audio	Realtek ALC888 HD Audio
Digital I/O	Programmable 8-bit GPIO with 12 pin-header
Internal I/O	2 x SATA3, 1 x RS232/422/485, 4 x RS232, 1 x PS/2, 4 x USB2.0, 1 x LVDS, 1 x LCD inverter, 1 x LPC, 1 x SMBUS, 1 x DIO, 1 x Audio, 1 x DC Out
Rear I/O	1 x RS232, 1 x HDMI/DVI-D, 1 x DisplayPort/DVI-D, 2 x USB3.0, 2 x LAN

### Mechanical & Environmental

Power Requirement	DC input 9~24V
Size & Thickness	146mm x 101mm (L x W), 1.6mm
Temperature	Operating within 0°C~60°C (32°F~140°F) Storage within -20°C~80°C (-4°F~176°F)
Relative Humidity	10%~90%, non-condensing

# 1.3 <Mechanical Drawing>

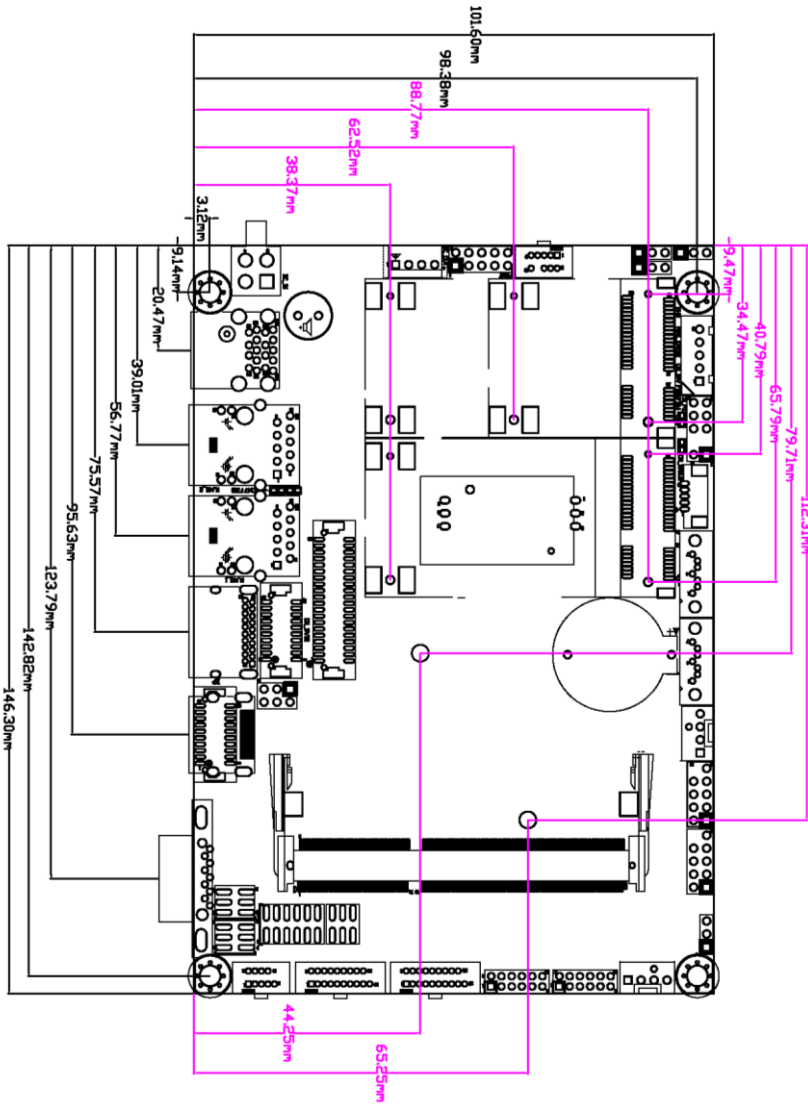

# 1.4 <Block Diagram>

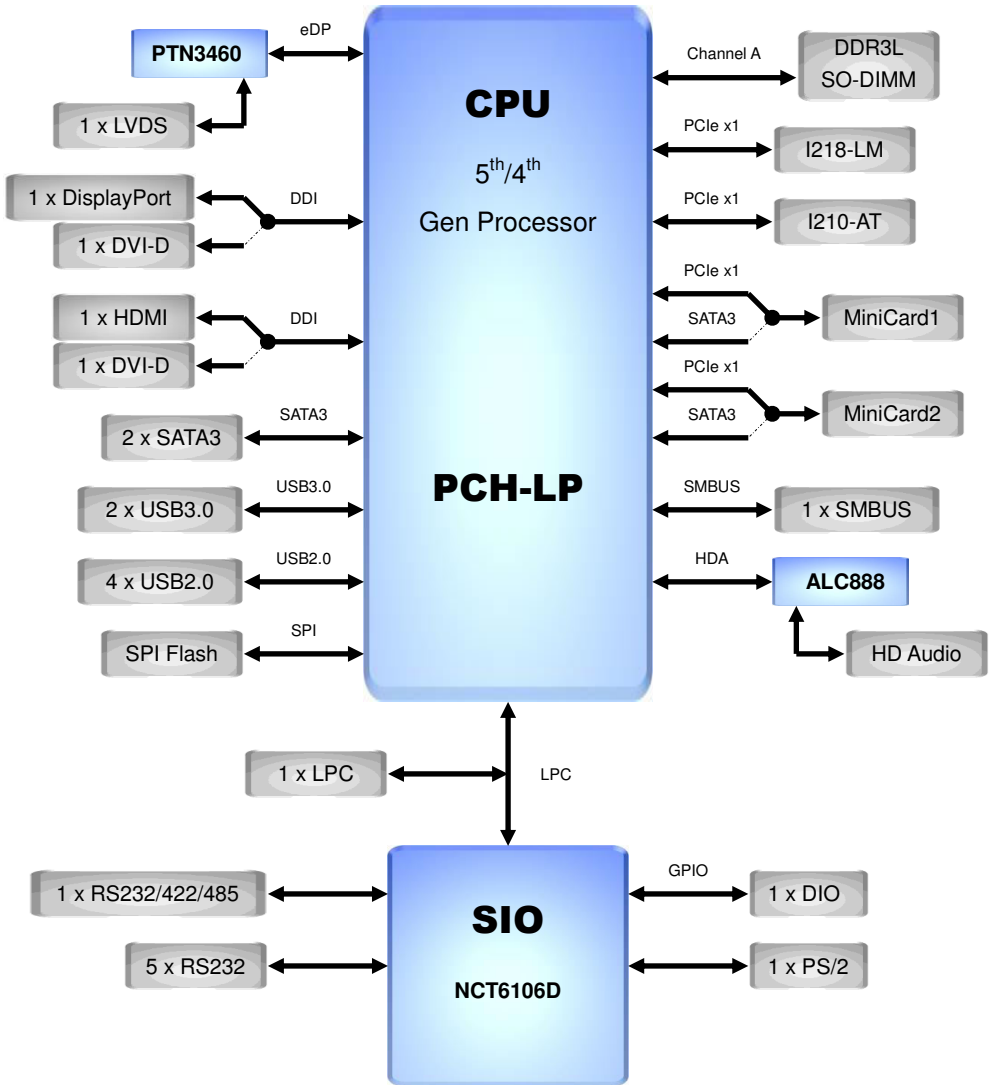



# Chapter 2 <Hardware setup>

## 2.1 <Connector Location and Reference>

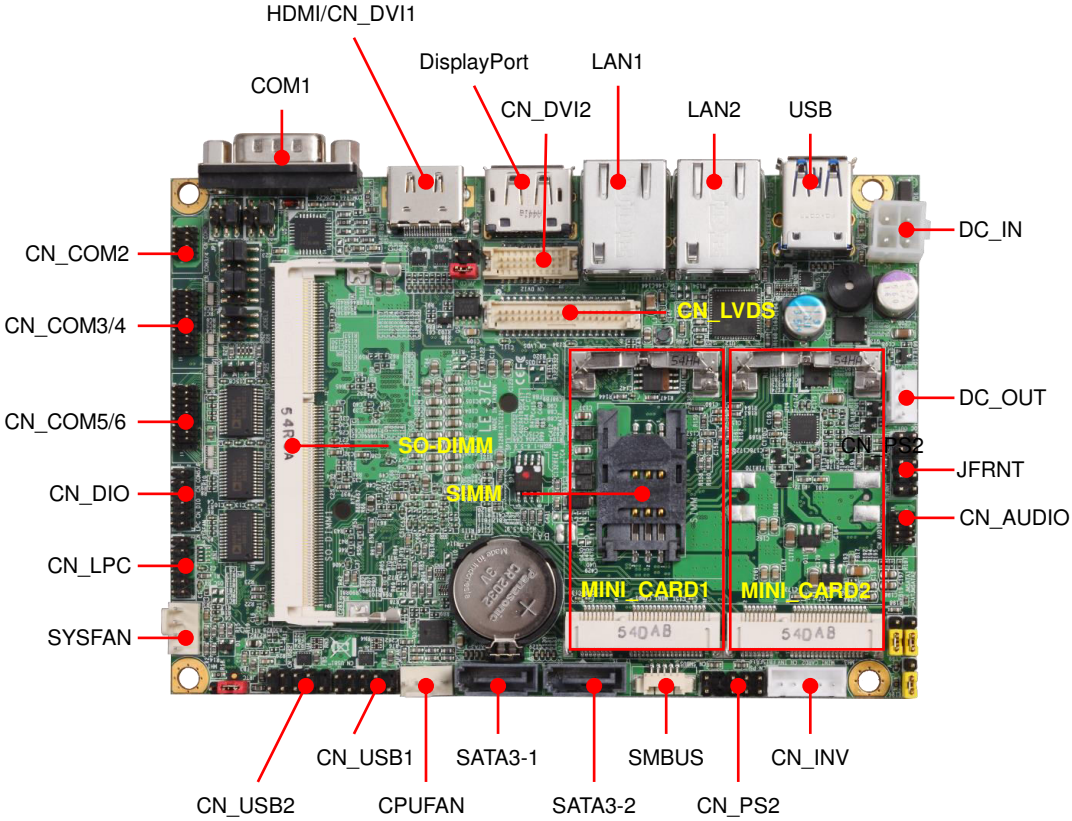

## 2.1.1 <Internal connectors list>

Connector	Function
SO-DIMM	204-pin DDR3L SO-DIMM slot
SATA3-1/2	7-pin Serial ATA3 connector
CN_AUDIO	5 x 2-pin audio pin header
CN_LPC	6 x 2-pin LPC pin header
CN_DIO	6 x 2-pin LPC pin header
CN_LVDS	20 x 2-pin LVDS connector
CN_INV	5-pin LCD inverter connector
CN_DVI1	10 x 2-pin DVI connector
CN_DVI2	10 x 2-pin DVI connector
CN_COM2	10-pin RS232/422/485 connector
CN_COM3/4	20-pin RS232 connector
CN_COM5/6	20-pin RS232 connector
CN_USB1/2	5 x 2-pin USB2.0 pin header
CN_PS2	5 x 2-pin PS/2 pin header
SMBUS	5-pin SMBus connector
SIMM	6-pin SIM card slot
CPUFAN	4-pin CPU fan connector
SYSFAN	4-pin system fan connector
JFRNT	5 x 2-pin front panel switch/indicator pin header
MINI_CARD1/2	52-pin MiniPCIe card slot
DC_OUT	4-pin SATA Power connector
DC_IN	4-pin ATX12V power connector

## 2.1.2 <External connectors list>

Connector	Function
COM1	DB9 connector
DisplayPort	DisplayPort connector
HDMI	HDMI connector
USB	2 x USB3.0 connector
LAN1	RJ45 connector
LAN2	RJ45 connector

## 2.2 <Jumper Location and Reference>

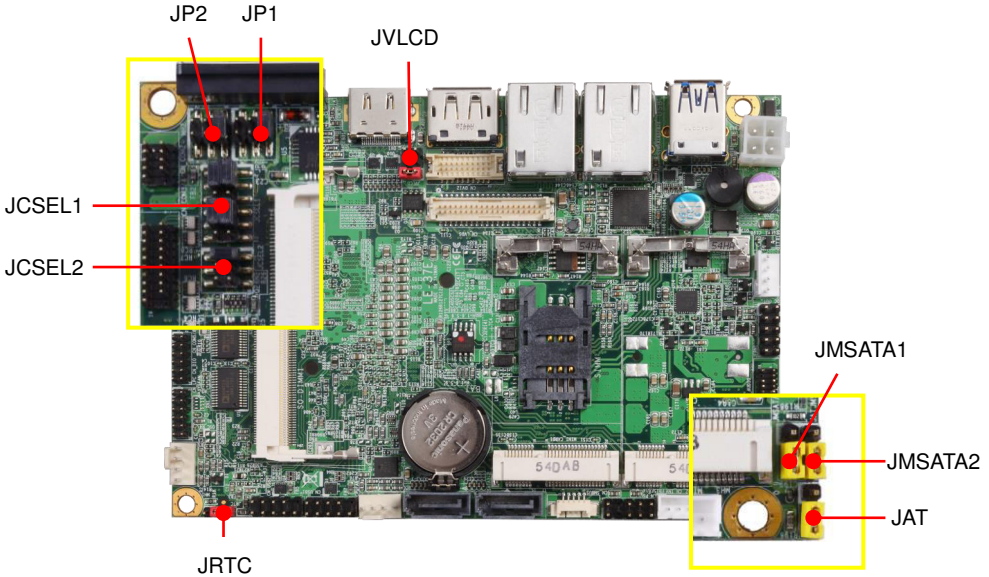

### 2.2.1 <Jumper list>

Jumper	Function
JAT	Power mode select
JRTC	CMOS Normal/Clear Setting
JVLCD	Panel Voltage Setting
JMSATA1/2	MiniCard1/2 mSATA Setting
JCSEL1/2	CN_COM2 RS232/422/485 select
JP1/2	COM1 and CN_COM2 9-pin setting

### 2.2.2 <Clear CMOS and Power on type selection>

**JRTC:** Clear CMOS data jumper

Jumper settings	Function
1-2	Clear CMOS
2-3	Normal (Default)

**JAT:** AT/ATX mode select jumper

Jumper settings	Function
1-2	AT mode
2-3	ATX mode (Default)

## 2.3 <Installing the Memory>

**In the process, the board must be powered off.**

1. Put the memory tilt into the slot. Note the Memory notch key aligned slot key.
2. Then press down till lock into the mounting notch.

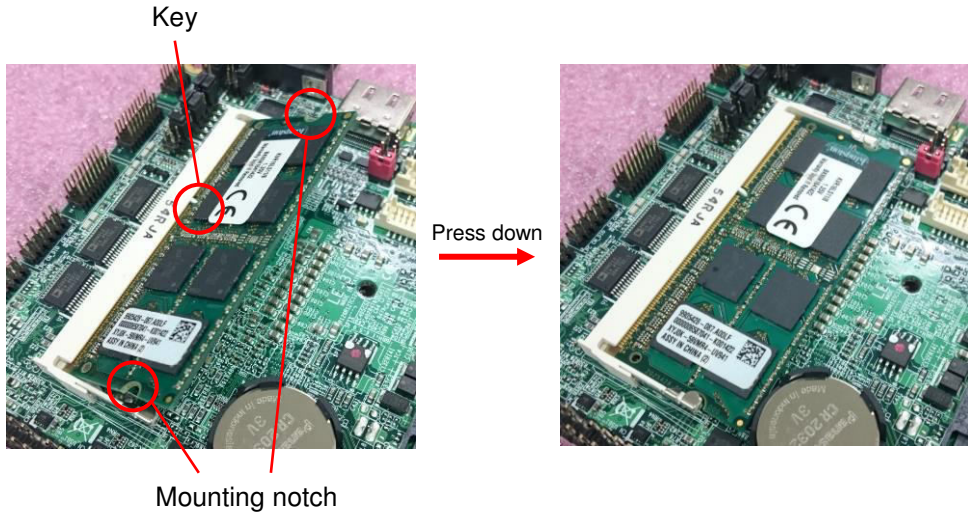

3. To remove the memory, push outward on both sides of the latch.

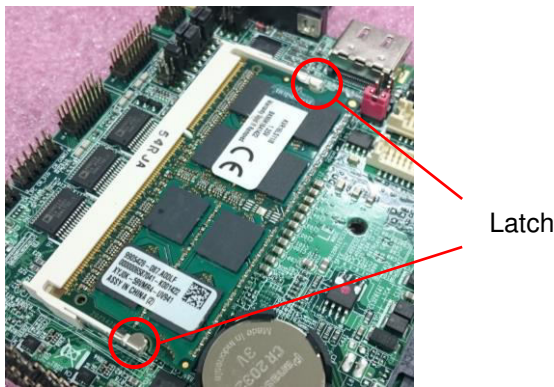

## 2.4 <I/O interface>

### 2.4.1 <Serial ATA interface>

Support RAID0 and 1.

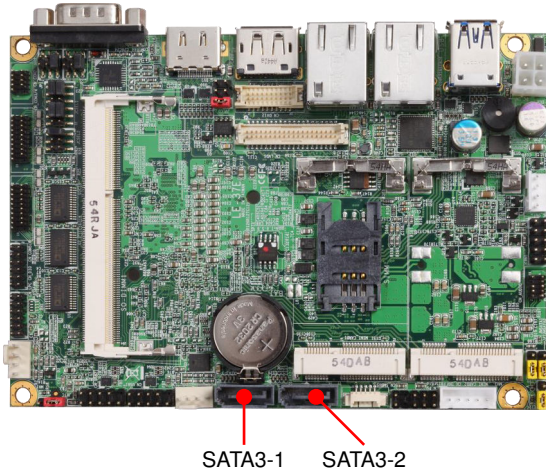

### 2.4.2 <Ethernet interface>

The board provide I210-AT and I218-LM Gigabit Ethernet which supports WOL on rear I/O.

It supports Intel® AMT 10.0 feature.

(Note that the CPU must support vPro technology, ex: [i7-5650U](#))

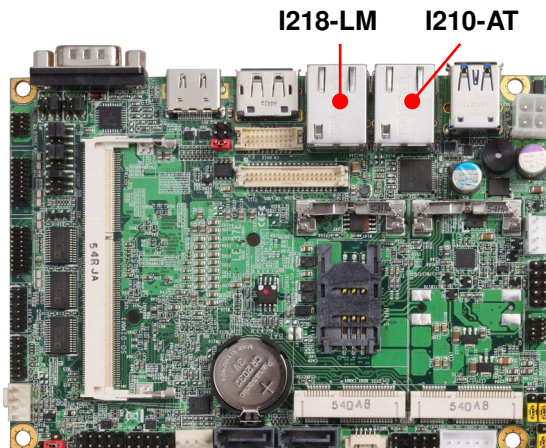

### 2.4.3 <Display interface>

Based on the 5th/4th Gen CPU with built-in HD Graphics, the DisplayPort up to **3840x2160 @ 60Hz**, the HDMI resolution up to **2560x1600 @ 60Hz** and LVDS (PTN3460) up to **1920x1200 @ 60Hz** support 18/24-bit color depth and dual channel.

The built-in HD Graphics support triple display function with clone mode and extended mode.

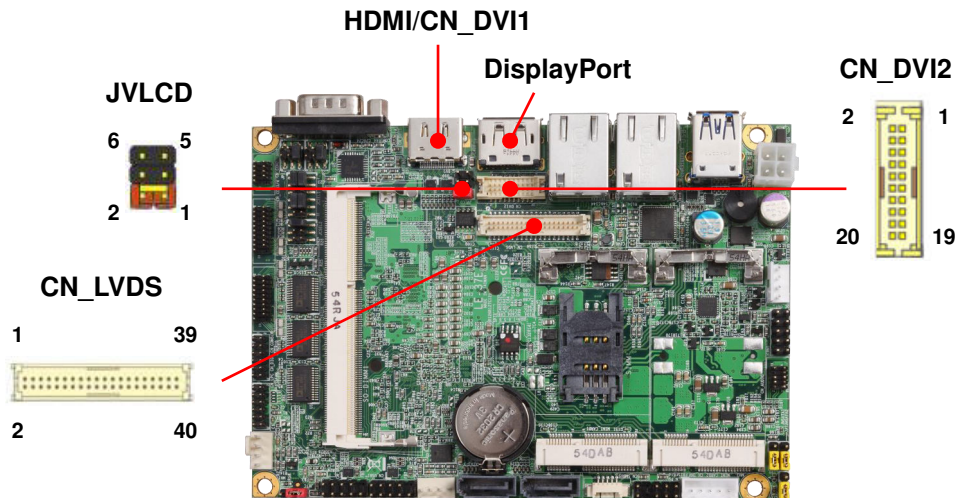

Note: HDMI connector can change like CN\_DVI12 pin-header.

#### CN\_DVI1/2: DVI 20-pin connector

Pin	Signal	Pin	Signal
1	5V	2	NC
3	HPD	4	GND
5	TMDS_TX0-	6	TMDS_TX0+
7	GND	8	TMDS_TX1-
9	TMDS_TX1+	10	GND
11	TMDS_TX2-	12	TMDS_TX2+
13	GND	14	TMDS_CLK-
15	TMDS_CLK+	16	GND
17	SDA	18	SCL
19	NC	20	NC

**CN\_LVDS:** LVDS 40-pin connector (Model: HIROSE DF13-40DP-1.25V compatible)

Pin	Signal	Pin	Signal
2	Set by JVLCD	1	Set by JVLCD
4	Detect (Active low)	3	GND
6	A_LVDS_0-	5	B_LVDS_0-
8	A_LVDS_0+	7	B_LVDS_0+
10	GND	9	GND
12	A_LVDS_1-	11	B_LVDS_1-
14	A_LVDS_1+	13	B_LVDS_1+
16	GND	15	GND
18	A_LVDS_2-	17	B_LVDS_2-
20	A_LVDS_2+	19	B_LVDS_2+
22	GND	21	GND
24	A_LVDS_CLK-	23	B_LVDS_3-
26	A_LVDS_CLK+	25	B_LVDS_3+
28	GND	27	GND
30	A_LVDS_3-	29	B_LVDS_CLK-
32	A_LVDS_3+	31	B_LVDS_CLK+
34	GND	33	GND
36	LVDS_DDCSCL	35	NC
38	LVDS_DDCSDA	37	NC
40	NC	39	NC

**Note:** Pin4 only need to be connected to GND

**CN\_INV:** LVDS 5-pin Backlight power connector

Pin	Signal
1	12V
2	Backlight Control
3	Reserve
4	GND
5	Enable Backlight

**JVLCD:** LVDS panel power select jumper

Jumper settings	Function
1-2	3.3V (Default)
3-4	5V
5-6	12V

**Effective patterns of connection: 1-2 / 3-4 / 5-6**

**Other may cause damage**

## 2.4.4 <Serial Port interface>

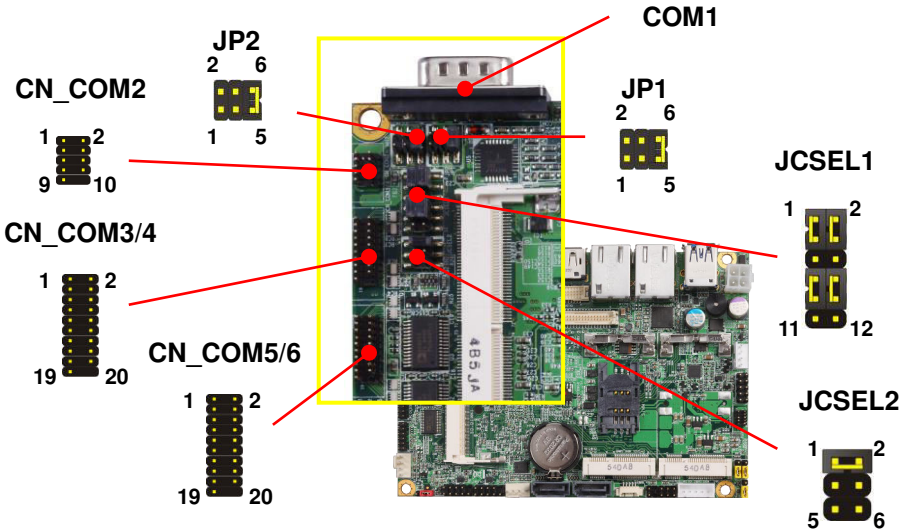

**COM1:** RS232 DB9 connector

Pin	Signal	Pin	Signal
1	DCD	2	RXD
3	TXD	4	DTR
5	GND	6	DSR
7	RTS	8	CTS
9	Set by JP2	10	Key

**CN\_COM2:** RS232/422/485 10-pin header (Pitch 1.27mm x 2.54mm)

Pin	Signal	Pin	Signal
1	DCD/ 422TX-/ 485-	2	RXD/ 422TX+/ 485+
3	TXD/ 422RX+	4	DTR/ 422RX-
5	GND	6	DSR
7	RTS	8	CTS
9	Set by JP1	10	Key

Use JCSEL1 and JCSEL2 to select communication mode



**COM3/4,5/6:** RS232 20-pin header (Pitch 1.27mm x 2.54mm)

Pin	Signal	Pin	Signal
1	DCD1	2	RXD1
3	TXD1	4	DTR1
5	GND	6	DSR1
7	RTS1	8	CTS1
9	RI1	10	NC
11	DCD2	12	RXD2
13	TXD2	14	DTR2
15	GND	16	DSR2
17	RTS2	18	CTS2
19	RI2	20	Key







**JP1, JP2:** COM1, COM2 pin-9 setting

Jumper settings	Function
1-2	5V
3-4	12V
5-6	RI (Default)

**Effective patterns of connection: 1-2 / 3-4 / 5-6**

**Other may cause damage**

**JCSEL1, JCSEL2:** For configure COM2 communication mode

Function	JCSEL1	JCSEL2
RS232		
RS485		
RS422		

## 2.4.5 <USB interface>

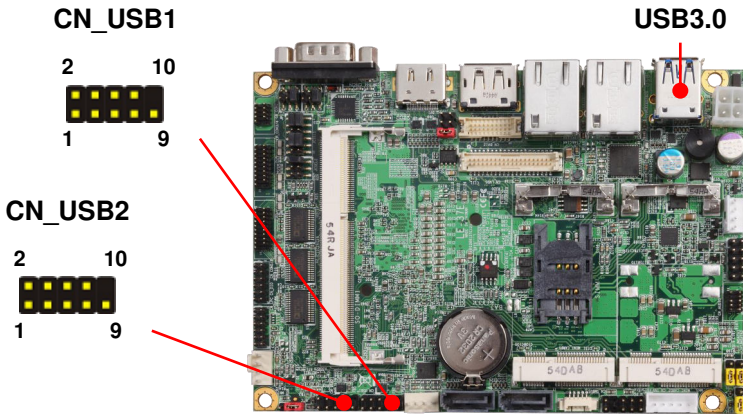

CN\_USB1/2: Front panel USB2.0 10-pin header (Pitch 2.54mm)

Pin	Signal	Pin	Signal
1	5VSB	2	5VSB
3	DATA0-	4	DATA1-
5	DATA0+	6	DATA1+
7	GND	8	GND
9	GND	10	Key

## 2.4.6 <Audio interface>

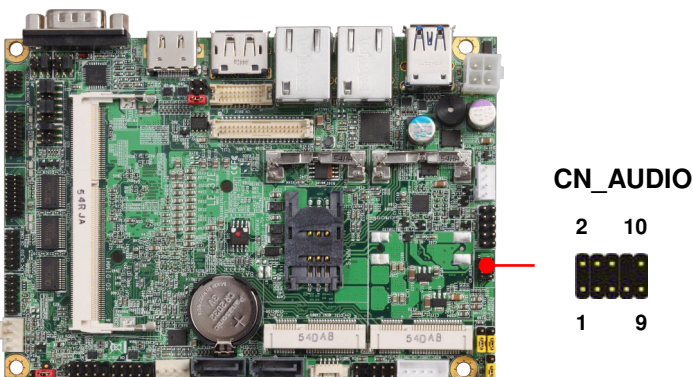

**CN\_AUDIO:** Front panel audio 10-pin header (Pitch 1.27mm x 2.54mm)

Pin	Signal	Pin	Signal
1	MIC_L	2	GND
3	MIC_R	4	NC
5	FP_OUT_R	6	MIC_DETECT
7	SENSE	8	Key
9	FP_OUT_L	10	FP_OUT_DETECT

### 2.4.7 <Expansion slot>

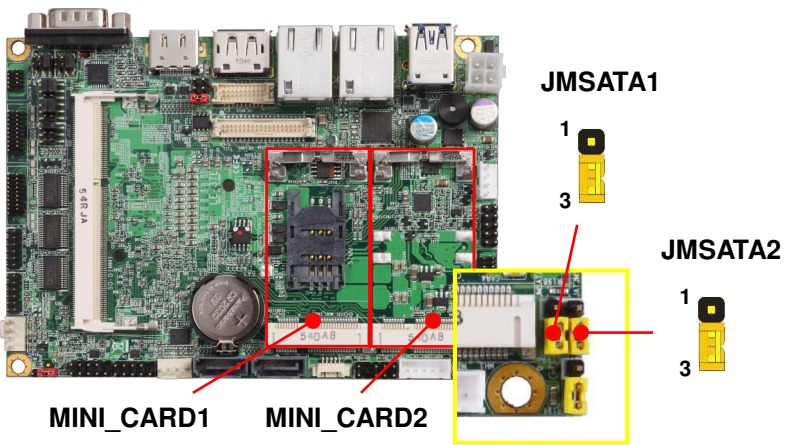

MINI\_CARD2 have some special design to compatible our MiniPCIe card (ex: MPX-574D2, MPX-210D2 etc) and MINI\_CARD1/2 supports mSATA set by JMSATA1/2.

MINI\_CARD1 supports SIM card to use 3G module.

**JMSATA1/2:** Setting MINI\_CARD1/2 to support PCIe/mSATA

Jumper settings	Function
1-2	Support mSATA
2-3	Normal operation (Default)

## 2.4.8 <Front panel switch and indicator>

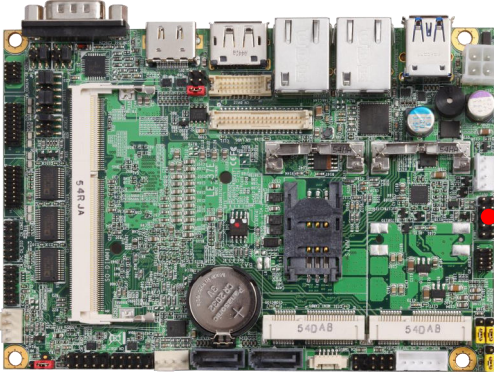
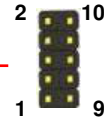
**JFRNT**

**JFRNT:** Front panel switch and indicator 14-pin header (Pitch 2.54mm)

Pin	Signal	Pin	Signal
1	Power_ON-	2	Power_ON+
3	Speaker-	4	Speaker+
5	HDD_LED-	6	HDD_LED+
7	Power_LED-	8	Power_LED+
9	Reset+	10	Reset-

## 2.4.9 <Other interface>

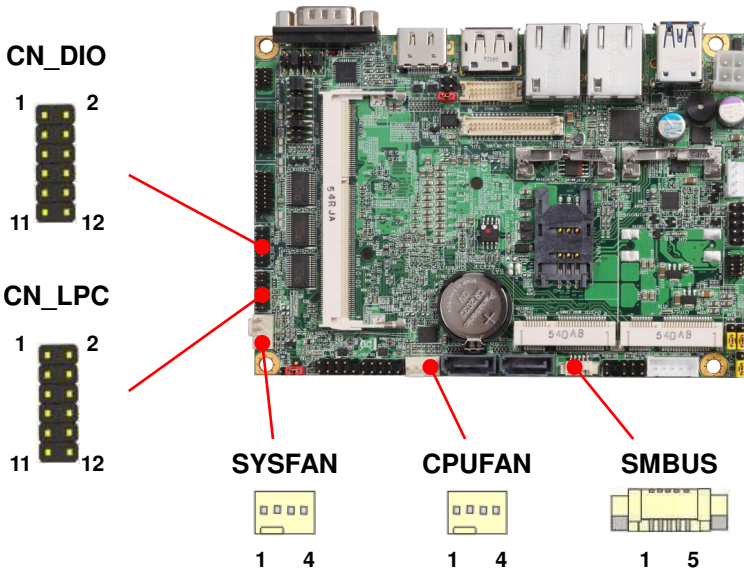

When using GPIO function, please note:

As Output: **Open-drain**, most applications **need use an external pull up resistor. (If not may cause damage)**

As Input: **TTL-level**.

### GPIO DC characteristics

Parameter	SYM	MIN	TYP	MAX	UNIT	Conditions
Input Low Voltage	$V_{IL}$			0.8	V	
Input High Voltage	$V_{IH}$	2.0			V	
Output Low Voltage	$V_{OL}$			0.4	V	$I_{OL} = 12\text{mA}$
Input High Leakage	$I_{LH}$			+10	$\mu\text{A}$	$V_{IN} = 3.3\text{V}$
Input Low Leakage	$I_{LH}$			-10	$\mu\text{A}$	$V_{IN} = 0\text{V}$

**CN\_DIO**: GPIO 12-pin header (Pitch 2.00mm)

Pin	Signal	Pin	Signal
1	GND	2	GND
3	GPIO0	4	GPIO4
5	GPIO1	6	GPIO5
7	GPIO2	8	GPIO6
9	GPIO3	10	GPIO7
11	5V	12	12V

**CN\_LPC**: LPC 12-pin header (Pitch 2.00mm)

Pin	Signal	Pin	Signal
1	CLK	2	RST
3	-LFRAME	4	LAD3
5	LAD2	6	LAD1
7	LAD0	8	3.3V
9	SERIRQ	10	GND
11	3.3VSB	12	NC

CN\_LPC support TPM module.

**SMBUS:** SMBus 5-pin connector

Pin	Signal
1	5V
2	NC
3	SMBDAT
4	SMBCLK
5	GND

**CPUFAN:** CPU cooler fan 4-pin connector

Pin	1	2	3	4
Signal	GND	12V	Sensor	Control

**SYSFAN:** System cooler fan 4-pin connector

Pin	1	2	3	4
Signal	GND	12V	Sensor	Control

## 2.5 <Power supply>

### 2.5.1 <Power input>

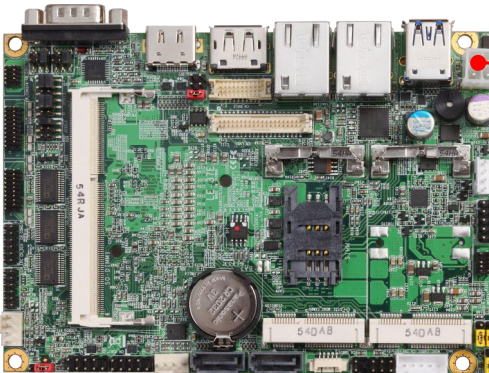

**DC\_IN**

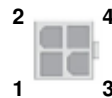

**DC\_IN:** ATX12V 4-pin power connector

Pin	Signal	Pin	Signal
1	GND	2	GND
3	9~24V Power input	4	9~24V Power input

## 2.5.2 <Power output>

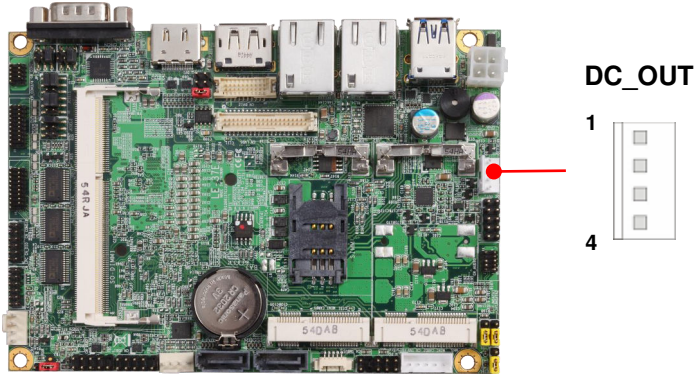

**DC\_OUT:** SATA power 4-pin connector

Pin	Signal
1	12V
2	GND
3	GND
4	5V

## Appendix A <Flash BIOS>

### A.1 <Flash tool>

The board is based on Phoenix BIOS and can be updated easily by the BIOS auto flash tool. You can download the tool online at the address below:

<http://www.commell.com.tw/Download/BIOS/FPT10.rar>

The tool's file name is "fpt.exe", it's the utility that can write the data into the BIOS flash chip and update the BIOS.

### A.2 <Flash BIOS process>

1. Please make a bootable UFD which can boot into DOS environment.
2. Unzip the flash tool and copy it into bootable UFD.
3. Add a bin file to the same folder..
4. Power on the system and flash the BIOS under the DOS environment.  
(Command: fpt -savemac -f xxx.bin)
5. Power off the system and then power on.



## Appendix B <Installation driver Notes>

### B.1 <iAMT(ME) driver>

Before installing, it need to install Microsoft Hotfix KB2685611 first for Win7 32/64 bit. More information please refer

<https://www.microsoft.com/en-us/download/details.aspx?id=38423>

### B.2 <USB3.0 driver>

Before Win7 install the USB3.0 driver or use in Win8 and Win8.1, xHCI needs to be enabled in the BIOS.

Note that if enable xHCI, all USB port will unusable in Win7. So first need copy driver folder to your HDD, then enable xHCI, and use PS/2 to do install. The path is "X:\Driver\USB3.0\Intel\_USB\_3.0\_xHC\_Driver\_4.0.0.27\_PV"

Advanced > South Bridge Configuration > SB USB Config > xHCI Mode

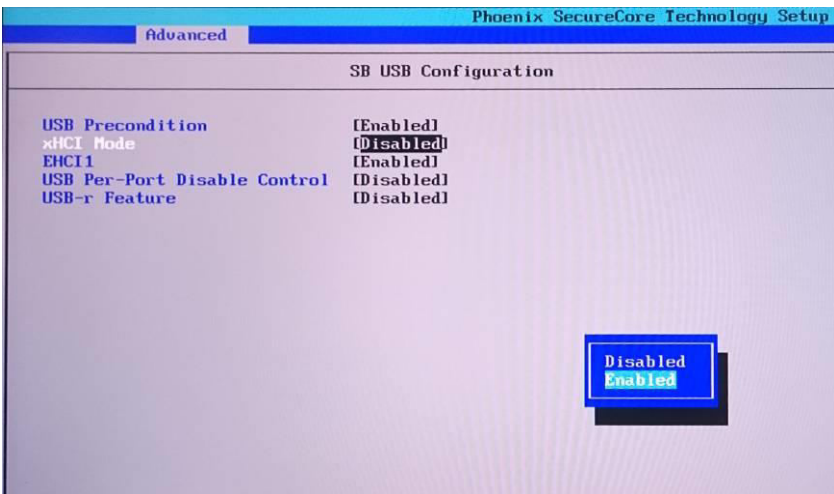

## Appendix C <LCD Panel Type select>

According to your panel, it needs to select the correct resolution in the BIOS. If there is no fit for your panel type, please provide feedback for us to make an OEM model.

BIOS panel type selection form (BIOS Version:1.0)			
Single / Dual channel		Single / Dual channel	
NO.	Type	NO.	Type
1	640 x 480	9	1600 x 1050
2	800 x 600	10	1920 x 1200
3	1024 x 768	11	Reserved
4	1280 x 1024	12	Reserved
5	1400 x 1050 Reduced Blanking	13	Reserved
6	1400 x 1050 non-Reduced Blanking	14	Reserved
7	1600 x 1200	15	Reserved
8	1200 x 768	16	Reserved

## Appendix D <Programmable GPIO >

The GPIO' can be programmed with the MS-DOS debug program using simple IN/OUT commands.

The DC characteristics please refer to GPIO paragraph (Page25).

GPIO	0	1	2	3	4	5	6	7
bit	0	1	2	3	4	5	6	7

- o 4E 87 ;enter configuration
- o 4E 87
- o 4E 07
- o 4F 07 ;select Logical Device
- o 4E 30
- o 4F 10 ;activate GPIO function (The board use GPIO3)
- o 4E F0
- o 4F XX ;set "01" GPIO as input, set "00" GPIO as output
- o 4E F1
- o 4F XX ;if set GPIO as output, this register's value can be set "00~ FF"

Optional

- o 4E F2
- o 4F XX ;set "01", the respective bit are inverted (Both input and output)
- ;set "00", the respective bit are normal

For further information, please refer to Nuvoton NCT6102D datasheet

## Appendix E <Programmable Watch Dog Timer>

### Timeout value range

1 to 255 Minute and Second

### Program sample

Watchdog timer setup as system reset with 5 second of timeout

```
-o 4E 87      ;enter configuration
-o 4E 87
-o 4E 07
-o 4F 08      ;select Logical Device
-o 4E 30
-o 4F 01      ; activate WDTO# function
-o 4E F5
-o 4F 00      ;set "00" is second mode, set "04" is minute mode
-o 4E F6
-o 4F 05      ;00h: Timeout Disable
                ;01h: Timeout occurs after 1 minute only
                ;02h: Timeout occurs after 2 second/minute
                ;03h: Timeout occurs after 3 second/minute
                ;
                ;FFh: Timeout occurs after 255 second/minute
                (The deviation is approx 1 second.)
```

For further information, please refer to Nuvoton NCT6102D datasheet

## Contact information

Any advice or comment about our products and service, or anything we can help you please don't hesitate to contact with us. We will do our best to support you for your products, projects and business.

### Taiwan Commate computer Inc.

<b>Address</b>	19F., NO.94, Sec. 1, Xintai 5 <sup>th</sup> Rd., Xizhi Dist., New Taipei City 22102, Taiwan.
<b>TEL</b>	+886-2-26963909
<b>FAX</b>	+886-2-26963911
<b>Website</b>	<a href="http://www.commell.com.tw">www.commell.com.tw</a>
<b>E-mail</b>	<a href="mailto:info@commell.com.tw">info@commell.com.tw</a> (General information) <a href="mailto:tech@commell.com.tw">tech@commell.com.tw</a> (Technical Support)

**Commell is a brand name of Taiwan Commate computer Inc.**