

# Contents

<b>1 Instructions</b>	<b>4</b>
1.1 General safety instructions	4
1.2 Manufacturer liability	5
1.3 Appliance purpose	5
1.4 Disposal	5
1.5 Identification plate	6
1.6 This user manual	6
1.7 How to read the user manual	6
<b>2 Description</b>	<b>7</b>
2.1 General Description	7
2.2 Control panel	8
2.3 Other parts	8
2.4 Available accessories	9
<b>3 Use</b>	<b>10</b>
3.1 Instructions	10
3.2 First use	10
3.3 Using the accessories	11
3.4 Using the oven	11
3.5 Cooking advice	13
3.6 Display	14
<b>4 Cleaning and maintenance</b>	<b>21</b>
4.1 Instructions	21
4.2 Cleaning the surfaces	21
4.3 Ordinary daily cleaning	21
4.4 Food stains or residues	21
4.5 Removing the door	21
4.6 Cleaning the door glazing	22
4.7 Removing the internal glass panels	22
4.8 Cleaning the inside of the oven	23
4.9 Vapor Clean: assisted oven cleaning (on some models only)	24
4.10 Pyrolysis: automatic oven cleaning (on some models only)	26
4.11 Extraordinary maintenance	28
<b>5 Installation</b>	<b>30</b>
5.1 Electrical connection	30
5.2 Cable replacement	30
5.3 Positioning	31

We advise you to read this manual carefully, which contains all the instructions for maintaining the appliance's aesthetic and functional qualities.

For further information on the product: [www.smeg.com](http://www.smeg.com)



# Instructions

## 1 Instructions

### 1.1 General safety instructions

#### Risk of personal injury

- During use the appliance and its accessible parts become very hot.
- Never touch the heating elements during use.
- Keep children under eight years of age at a safe distance if they are not constantly supervised.
- Children must never play with the appliance.
- Never rest metallic objects such as knives, forks, spoons and lids on the appliance during use.
- Switch the appliance off immediately after use.
- Never try to put out a fire or flames with water: turn off the appliance and smother the flames with a fire blanket or other appropriate cover.
- The appliance must never be cleaned by unsupervised children.
- Have qualified personnel carry out installation and assistance interventions according to the standards in force.
- Do not modify this appliance.
- Do not insert pointed metal objects (cutlery or utensils) into the slots in the appliance.

- Do not try to repair the appliance yourself or without the intervention of a qualified technician.
- If the power supply cable is damaged, contact technical support immediately and they will replace it.

#### Risk of damaging the appliance

- Do not use abrasive or corrosive detergents on glass parts (e.g. powder products, stain removers and metallic sponges).
- Use wooden or plastic utensils.
- Do not seat on the appliance.
- Do not use steam jets for cleaning the appliance.
- Do not obstruct ventilation openings and heat dispersal slots.
- Never leave the appliance unattended during cooking operations where fats or oils could be released.
- Never leave objects on the cooking surface.
- Do not use the appliance to heat rooms for any reason.



## For this appliance

- Ensure that the appliance is switched off before replacing the bulb.
- Do not rest any weight or sit on the open door of the appliance.
- Take care that no objects are stuck in the doors.

## 1.2 Manufacturer liability

The manufacturer declines all liability for damage to persons or property caused by:

- use of the appliance other than the one envisaged;
- non-observance of the user manual provisions;
- tampering with any part of the appliance;
- use of non-original spare parts.

## 1.3 Appliance purpose

- This appliance is intended for cooking food in the home environment. Every other use is considered improper.
- This appliance may be used by children aged at least 8 and by people of reduced physical and mental capacity, or lacking in experience in the use of electrical appliances, as long they are supervised or instructed by adults who are responsible for their safety.
- The appliance is not designed to operate with external timers or with remote-control systems.

## 1.4 Disposal



This appliance must be disposed of separately from other waste (Directives 2002/95/EC, 2002/96/EC, 2003/108/EC). The appliance does not contain substances in quantities sufficient to be considered hazardous to health and the environment, in accordance with current European directives.

To dispose of the appliance:

- Cut the power supply cable and remove it along with the plug.



**Power voltage**

**Danger of electrocution**

- Disconnect the main power supply.
- Disconnect the power cable from the electrical system.
- Consign the appliance to the appropriate selective collection centres for electrical and electronic equipment waste, or deliver it back to the retailer when purchasing an equivalent product, on a one for one basis.



# Instructions

Our appliances are packed in non-polluting and recyclable materials.

- Consign the packing materials to the appropriate selective collection centres.



## Plastic packaging Danger of suffocation

- Do not leave the packaging or any part of it unattended.
- Do not let children play with the packaging plastic bags.

## 1.5 Identification plate

The identification plate bears the technical data, serial number and brand name of the appliance. Do not remove the identification plate for any reason.

## 1.6 This user manual

This user manual is an integral part of the appliance and must therefore be kept in its entirety and in an accessible place for the whole working life of the appliance.

Read this user manual carefully before using the appliance.

## 1.7 How to read the user manual

This user manual uses the following reading conventions:

### Instructions



General information on this user manual, on safety and final disposal.

### Description



Description of the appliance and its accessories.

### Use



Information on the use of the appliance and its accessories, cooking advice.

### Cleaning and maintenance



Information for proper cleaning and maintenance of the appliance.

### Installation



Information for the qualified technician: installation, operation and inspection.



Safety instructions



Information



Advice

1. Use instruction sequence.

- Single use instruction.



## 2 Description

### 2.1 General Description

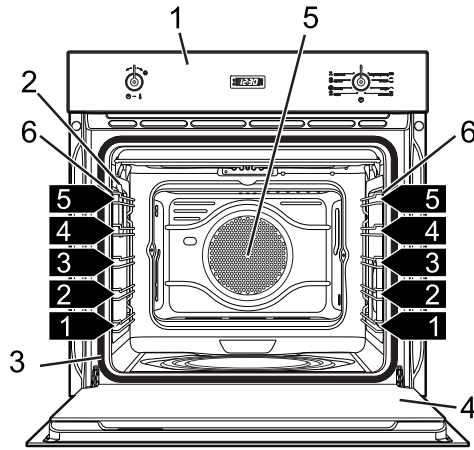

Multifunction models

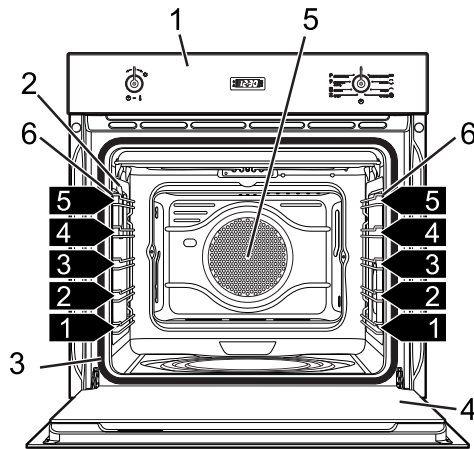

Pyrolytic models

- 1 Control panel
- 2 Oven light
- 3 Seal
- 4 Door

- 5 Fan
- 6 Rack/tray support frames
- 1,2,3... Frame shelf



# Description

## 2.2 Control panel

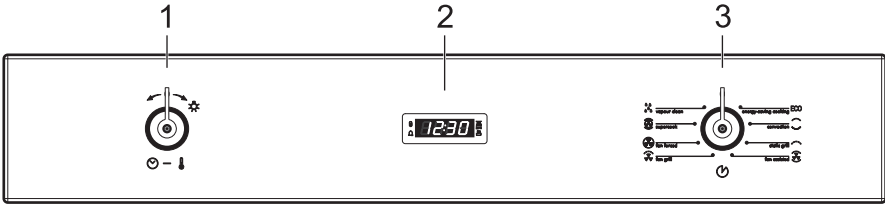

Multifunction models

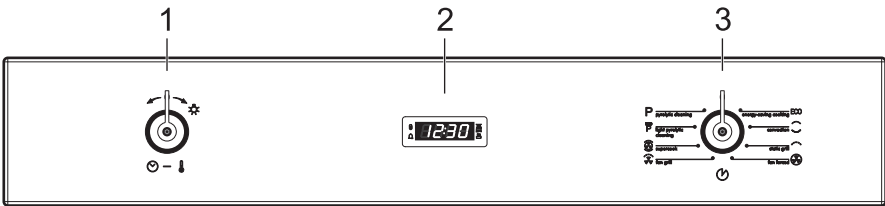

Pyrolytic models

### Temperature knob (1)

This knob allows you to select the cooking temperature, the cooking time and to set programmed cooking and time.

### Display (2)

Useful for displaying the current time and the cooking temperature, for setting programmed cooking operations and for programming the timer.

### Function knob (3)

The oven's various functions are suitable for different cooking modes. After selecting the required function, set the cooking temperature using the temperature knob.

## 2.3 Other parts

### Shelves

The appliance features shelves for positioning trays and racks at different heights. The insertion heights are indicated from the bottom upwards (see 2.1 General Description).

### Interior lighting

The oven light comes on when the door is opened, by turning the temperature knob, or when any function is selected, except for

 and  functions.



## Cooling fan

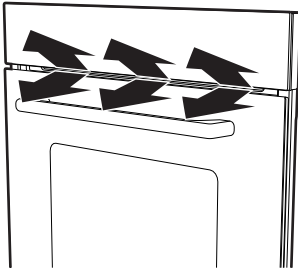

The fan cools the oven and comes into operation during cooking.

The fan causes a steady outflow of air from above the door which may continue for a brief period of time even after the appliance has been turned off.

## 2.4 Available accessories

**i** Some models are not provided with all accessories.

## Rack

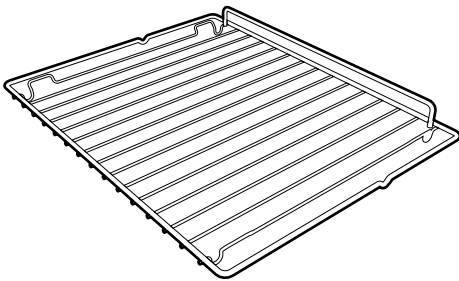

Useful for supporting containers with food during cooking.

## Tray rack

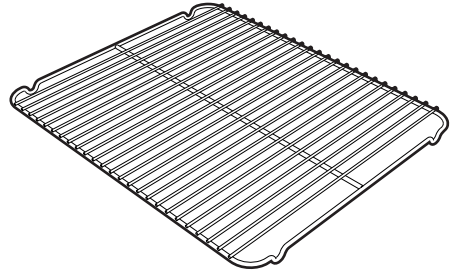

To be placed over the top of the oven tray; for cooking foods which may drip.

## Deep tray

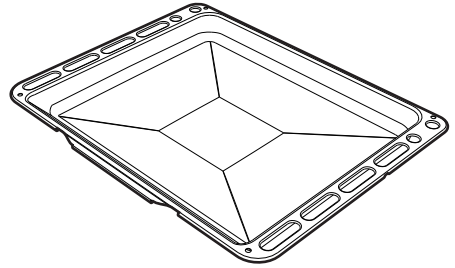

Useful for collecting fat from foods placed on the rack above and for cooking pies, pizzas and baked desserts.

**i** The oven accessories intended to come into contact with food are made of materials that comply with the provisions of current legislation.

**i** Original supplied and optional accessories can be requested to Authorised Assistance Centres. Use only original accessories supplied by the manufacturer.



## 3 Use

### 3.1 Instructions



**High temperature inside the oven during use**

**Danger of burns**

- Keep the oven door closed during cooking.
- Protect your hands wearing heat resistant gloves when moving food inside the oven.
- Do not touch the heating elements inside the oven.
- Do not pour water directly onto very hot trays.
- Do not allow children to get near the oven when it is in operation.



**High temperature inside the oven during use**

**Danger of fire or explosion**

- Do not spray any spray products near the oven.
- Do not use or leave flammable materials near the oven.
- Do not use plastic kitchenware or containers when cooking food.
- Do not put sealed tins or containers in the oven.
- Do not leave the oven unattended during cooking operations where fats or oils could be released.
- Remove all trays and racks which are not required during cooking.



**Improper use**

**Risk of damage to enamelled surfaces**

- Do not cover the bottom of the cooking compartment with aluminium or tin foil sheets.
- If you wish to use greaseproof paper, place it so that it will not interfere with the hot air circulation inside the oven.
- Do not place pans or trays directly on the bottom of the cooking compartment.
- Do not pour water directly onto very hot trays.

### 3.2 First use

1. Remove any protective film from the outside or inside of the appliance, including accessories.
2. Remove any labels (apart from the technical data plate) from the accessories and from the cooking compartment.
3. Remove and wash all the appliance accessories (see 4 Cleaning and maintenance).
4. Heat the empty oven at the maximum temperature to burn off any residues left by the manufacturing process.





### 3.3 Using the accessories

#### Racks and trays

Racks and trays have to be inserted into the side guides until they come to a complete stop.

- The mechanical safety locks that prevent the rack from being taken out accidentally have to face downwards and towards the oven back.

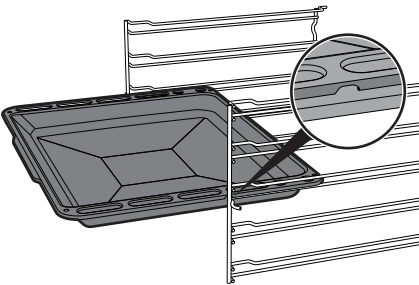
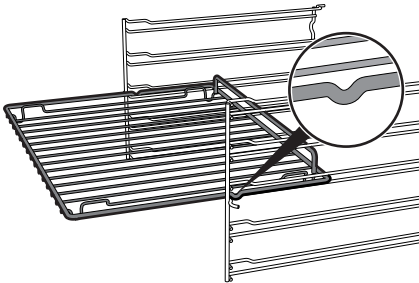

#### Tray rack

The tray rack has to be inserted into the tray. In this way fat can be collected separately from the food which is being cooked.

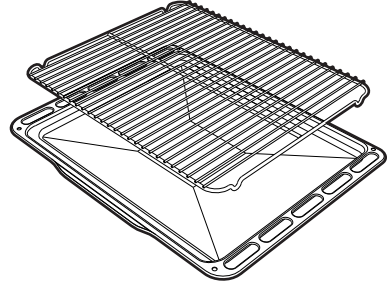

### 3.4 Using the oven

#### Switching the oven on

To switch the oven on:

1. Select the cooking function using the function knob.
2. Select the temperature using the temperature knob.



Gently insert racks and trays into the oven until they come to a stop.



Clean the trays before using them for the first time to remove any residues left by the manufacturing process.



## Functions list



### Convection (Static)

As the heat comes from above and below at the same time, this system is particularly suitable for certain types of food. Traditional cooking, also known as static cooking, is suitable for cooking just one dish at a time. Perfect for all types of roasts, bread and cakes and in any case particularly suitable for fatty meats such as goose and duck.



### Static grill (Grill)

The heat coming from the grill element gives perfect grilling results above all for thin and medium thickness meat and in combination with the rotisserie (where fitted) gives the food an even browning at the end of cooking. Perfect for sausages, ribs and bacon. This function enables large quantities of food, particularly meat, to be grilled evenly.



### Fan assisted (Fan-assisted static)

The operation of the fan, combined with traditional cooking, ensures uniform cooking even with complex recipes. Perfect for biscuits and cakes, even when simultaneously cooked on several levels. (For multiple-level cooking, we recommend using the 2<sup>nd</sup> and 4<sup>th</sup> shelves.)



### Fan grill (Fan-assisted grill)

The air produced by the fan softens the strong heatwave generated by the grill, grilling perfectly even very thick foods. Perfect for large cuts of meat (e.g. shin of pork).



### Fan forced (Fan-assisted circular)

The combination of the fan and the circular element (incorporated in the rear of the oven) allows you to cook different foods on several levels, as long as they need the same temperatures and same type of cooking. Hot air circulation ensures instant and uniform distribution of heat. It will be possible, for instance, to cook fish, vegetables and biscuits simultaneously (on different levels) without mixing odours and flavours.



### Supercook (Turbo)

The combination of fan-assisted cooking and traditional cooking allows different foods to be cooked on several levels extremely quickly and efficiently, without odours and flavours mingling. Perfect for large volumes that call for intense cooking.



### Energy-saving cooking (Eco)

Using the grill and the lower heating element in combination is particularly suitable for cooking on a single shelf, as it provides low energy consumption.



## 3.5 Cooking advice

### General advice

- Use a fan-assisted function to achieve uniform cooking at several levels.
- It is not possible to shorten cooking times by increasing the temperature (the food could be overcooked on the outside and undercooked on the inside).

### Advice for cooking meat

- Cooking times vary according to the thickness and quality of the food and to consumer taste.
- Use a meat thermometer when roasting meat, or simply press on the roast with a spoon. If it is hard, it is ready; if not, it needs another few minutes cooking.

### Advice for cooking with the Grill and the Fan-assisted grill

- Meat can be grilled even when it is put into the cold oven or into the preheated oven if you wish to change the effect of the cooking.
- With the Fan-assisted grill function, we recommend that you preheat the oven before grilling.
- We recommend placing the food at the centre of the rack.
- With the Grill function, we recommend that you turn the temperature knob to the maximum value near the  symbol to optimise cooking.

### Advice for cooking desserts and biscuits

- Use dark metal moulds: they help to absorb the heat better.
- The temperature and the cooking time depend on the quality and consistency of the dough.
- To check whether the dessert is cooked right through: at the end of the cooking time, put a toothpick into the highest point of the dessert. If the dough does not stick to the toothpick, the dessert is cooked.
- If the dessert collapses when it comes out of the oven, on the next occasion reduce the set temperature by about 10°C, selecting a longer cooking time if necessary.

### Advice for defrosting and proving

- Place frozen foods without their packaging in a lidless container on the first shelf of the oven.
- Avoid overlapping the food.
- To defrost meat, use the rack placed on the second level and a tray on the first level. In this way, the liquid from the defrosting food drains away from the food.
- The most delicate parts can be covered with aluminium foil.
- For successful proving, a container of water should be placed in the bottom of the oven.



## Use

### To save energy

- Stop cooking a few minutes before the time normally used. Cooking will continue for the remaining minutes with the heat which has accumulated inside the oven.
- Reduce any opening of the door to a minimum to avoid heat dispersal.
- Keep the inside of the appliance clean at all times.

### 3.6 Display



- Door lock indicator light
- Minute minder timer indicator light
- Timed cooking with delayed start indicator light
- Child lock indicator light
- Timed cooking indicator light

### Operating modes

**Stand-by:** When the function knob is positioned on 0, the display shows the current time.



**ON:** When the function knob is positioned on any other function different from 0, the display shows the set temperature



or "Pyro" if the pyrolysis (automatic cleaning cycle) is taking place.



### Setting the time

On the first use, or after a power failure, **00:00** will be flashing on the appliance's display. To be able to start any cooking function, the current time must be set.



Turn the temperature knob right or left to reduce or increase the displayed time. Keep it in the turned position to reduce or increase more rapidly.



It may become necessary to change the current time, for example for daylight saving time. Hold the temperature knob turned to the right or left until the value changes. It is not possible to change the time if the oven is **ON**.



## Cooking functions

To select a cooking function, turn the function selection knob right or left. The oven starts cooking at the pre-set temperature. Cooking itself is preceded by a preheating stage, which allows the oven to heat to the cooking temperature more quickly.  flashes to indicate that this stage is in progress. When the preheating stage is over,  will remain lit steadily and a buzzer will sound to indicate that the food can be placed inside the oven.



Cooking can be interrupted at any time by turning the function knob to 0.



## Modifying the pre-set temperature

The pre-set temperature for each function can be changed to suit the user's requirements. At any time while cooking is in progress, turn the temperature knob right or left to increase or decrease the cooking temperature by 5 degrees at a time. Keep the knob turned to produce a faster increase or decrease.

## Timed cooking



Timed cooking is the function which allows a cooking operation to be started and then ended after a specific length of time set by the user.

1. After selecting a cooking function and temperature, press the temperature knob twice. The display shows  and the  indicator light flashes.



2. Turn the knob right or left to set the minutes of cooking from 00:01 to 12:59. Keep the knob turned to produce a faster increase or decrease.



3. A few seconds after the required duration is set, the  indicator light stops flashing and timed cooking starts.
4. At the end of the cooking time STOP appears on the display and a buzzer will sound that can be deactivated by pressing the temperature knob.





# Use



To select a further timed cooking, turn the knob right or left again.





To extend the cooking time manually, press the temperature knob again. The appliance will restart its normal operation with the previously selected cooking settings.



To switch the appliance off, turn the function knob to 0.

## Modifying the data set during timed cooking



During operation, it is possible to modify timed cooking duration:

1. When the  indicator light is steady and the appliance is in the cooking phase, press the temperature knob twice. The  indicator light will start flashing.
2. Turn the temperature knob right or left to alter the preset cooking time.

## Programmed cooking







Programmed cooking is the function which allows a cooking operation to be stopped at an established time depending on the time set by the user, after which the oven will switch off automatically.

1. After selecting a cooking function and temperature, press the temperature knob twice. The display shows  and the  indicator light flashes.



2. Turn the knob right or left to set the minutes of cooking from 00:01 to 12:59. Keep the knob turned to produce a faster increase or decrease.



3. A few seconds after the required duration is set, the  indicator light stops flashing.
4. Press the temperature knob. The  indicator light flashes. Turn the knob right or left to set the cooking end time.
5. After a few seconds the  and  indicator lights stop flashing. The appliance waits for the set start time.



6. At the end of the cooking time STOP appears on the display and a buzzer will sound that can be deactivated by pressing the temperature knob.



To extend the cooking time manually, press the temperature knob again. The appliance will restart its normal operation with the previously selected cooking settings.









To switch the appliance off, turn the function knob to 0.



For safety reasons, it is not possible to set the cooking end time by itself without setting the cooking duration.

## Modifying the data set during programmed cooking

During operation, it is possible to modify programmed cooking duration:

1. When the  and  indicator lights are steady and the appliance waits for the cooking to start, press the temperature knob. The  indicator light will start flashing.
2. Turn the temperature knob right or left to alter the preset cooking time.
3. Press the temperature knob again. The  indicator light switches off and the  indicator light starts flashing. The display shows the cooking end time.
4. Turn the temperature knob right or left to delay the cooking end time.
5. After a few seconds the  and  indicator lights stop flashing and programmed cooking restarts its operation with the new settings.





## Use

### Minute minder

**i** This function only activates the buzzer, without stopping cooking.

1. Press the temperature knob. The display shows **00:00** and the  indicator light flashes.



2. Turn the knob right or left to set the duration (from 1 minute to 4 hours). After a few seconds, the  indicator light stops flashing and the countdown starts.
3. Select the required cooking function and wait for the buzzer to sound, indicating that the cooking time is over.
4. Press the temperature knob to stop the buzzer. The  indicator light flashes.
5. Turn the knob right or left to select a further minute minder.

### Secondary menu

The appliance also has a drop-down secondary menu allowing the user to:

- Activate or deactivate the Child Lock.
- Activate or deactivate Showroom mode (which disables all the heating elements so that only the control panel works).
- Activate or deactivate Low Power mode.

With the appliance in Stand-By status

1. Press and hold the temperature knob down for at least 5 seconds.
2. Turn the temperature knob right or left to change the setting status (ON/OFF).
3. Press the temperature knob to move to the next mode.

**Child Lock mode:** This mode allows the appliance to automatically lock the controls after one minute of normal operation without any intervention from the user.



During normal operation it is indicated by the  indicator light coming on.

To temporarily release the lock during cooking, hold the temperature knob down for 5 seconds. One minute after the last setting the lock will become active again.



Touching or varying the position of the temperature and function knobs, the display will show "bloc" for two seconds.





### Showroom mode (for exhibitors only):

This mode allows the appliance to deactivate all heating elements, while keeping the control panel active.



To use the appliance normally, set this mode to OFF.



**Low Power mode:** This mode allows the appliance to limit the power used.

HI: normal power.



LO: low power.



Touching or varying the position of the temperature and function knobs, the display will show "bloc" for two seconds.



# Use

## Cooking information table

Food	Weight (Kg)	Function	Runner position from the bottom	Temperature (°C)	Time (minutes)	
Lasagne	3 - 4	Convection	1	220 - 230	45 - 50	
Pasta bake	3 - 4	Convection	1	220 - 230	45 - 50	
Roast veal	2	Supercook	2	180 - 190	90 - 100	
Pork	2	Supercook	2	180 - 190	70 - 80	
Sausages	1.5	Fan Static grill	4	280	15	
Roast beef	1	Supercook	2	200	40 - 45	
Roast rabbit	1.5	Fan forced	2	180 - 190	70 - 80	
Turkey breast	3	Supercook	2	180 - 190	110 - 120	
Roast pork neck	2 - 3	Supercook	2	180 - 190	170 - 180	
Roast chicken	1.2	Supercook	2	180 - 190	65 - 70	
					1 <sup>nd</sup> surface	2 <sup>nd</sup> surface
Pork chops	1.5	Fan Static grill	4	280	15	5
Spare ribs	1.5	Fan Static grill	4	280	10	10
Bacon	0.7	Static grill	5	250 - 280	7	8
Pork fillet	1.5	Fan Static grill	4	250 - 280	10	5
Beef fillet	1	Static grill	5	250 - 280	10	7
Salmon trout	1.2	Supercook	2	150 - 160	35 - 40	
Monkfish	1.5	Supercook	2	160	60 - 65	
Supercookt	1.5	Supercook	2	160	45 - 50	
Pizza	1	Supercook	2	280	8 - 9	
Bread	1	Fan forced	2	190 - 200	25 - 30	
Focaccia	1	Supercook	2	180 - 190	20 - 25	
Sponge cake	1	Fan forced	2	160	55 - 60	
Jam tart	1	Fan forced	2	160	35 - 40	
Ricotta cake	1	Fan forced	2	160 - 170	55 - 60	
Jam tarts	1	Supercook	2	160	20 - 25	
Paradise cake	1.2	Fan forced	2	160	55 - 60	
Cream puffs	1.2	Supercook	2	180	80 - 90	
Light sponge cake	1	Fan forced	2	150 - 160	55 - 60	
Rice pudding	1	Supercook	2	160	55 - 60	
Brioches	0.6	Fan forced	2	160	30 - 35	

The times indicated in the table do not include preheating times and are provided as a guide only.



## 4 Cleaning and maintenance

### 4.1 Instructions



**Improper use**  
**Risk of damage to surfaces**

- Do not use steam jets for cleaning the appliance.
- Do not use cleaning products containing chlorine, ammonia or bleach on steel parts or parts with metallic finishes on the surface (e.g. anodizing, nickel- or chromium-plating).
- Do not use abrasive or corrosive detergents on glass parts (e.g. powder products, stain removers and metallic sponges).
- Do not use rough or abrasive materials or sharp metal scrapers.

### 4.2 Cleaning the surfaces

To keep the surfaces in good condition, they should be cleaned regularly after use. Let them cool first.

### 4.3 Ordinary daily cleaning

Always use only specific products that do not contain abrasives or chlorine-based acids.

Pour the product onto a damp cloth and wipe the surface, rinse thoroughly and dry with a soft cloth or a microfibre cloth.

### 4.4 Food stains or residues

Do not use metallic sponges or sharp scrapers as they will damage the surfaces.

Use ordinary non-abrasive products with the aid of wooden or plastic utensils if necessary. Rinse thoroughly and dry with a soft cloth or a microfibre cloth.

Do not allow residues of sugary foods (such as jam) to set inside the oven. If left to set for too long, they might damage the enamel lining of the oven.

### 4.5 Removing the door

For easier cleaning, the door can be removed and placed on a canvas.

To remove the door proceed as follows:

1. Open the door completely and insert two pins into the holes on the hinges indicated in the figure.

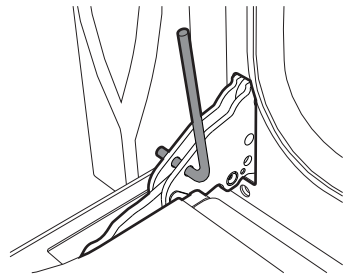

2. Grasp the door on both sides with both hands, lift it forming an angle of around 30° and remove it.



## Cleaning and maintenance

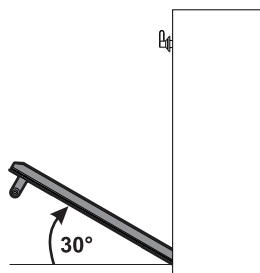

3. To reassemble the door, put the hinges in the relevant slots in the oven, making sure that grooved sections **A** are resting completely in the slots. Lower the door and once it is in place remove the pins from the holes in the hinges.

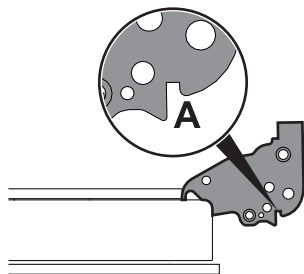

### 4.6 Cleaning the door glazing

The glass in the door should always be kept thoroughly clean. Use absorbent kitchen roll. In case of stubborn dirt, wash with a damp sponge and an ordinary detergent.



We recommend the use of cleaning products distributed by the manufacturer.

### 4.7 Removing the internal glass panels

For easier cleaning the door internal glass panels can be disassembled.

1. Remove the internal glass panel by pulling the rear part gently upwards, following the movement indicated by the arrows (1).
2. Then, pull the front part upwards (2). In this way, the 4 pins attached to the glass detach from their housings in the oven door.

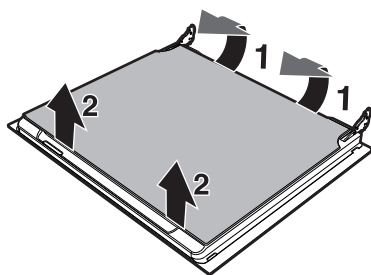

3. Some models have an intermediate glass panel. Remove the intermediate glass panel by lifting it upwards.

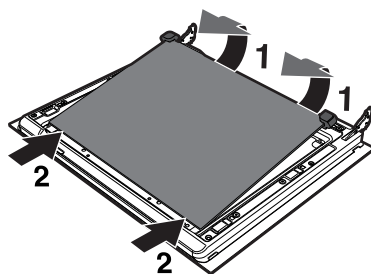



4. Clean the external glass panel and the panels previously removed. Use absorbent kitchen roll. In case of stubborn dirt, wash with a damp sponge and neutral detergent.

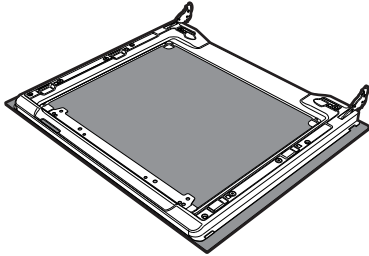

5. Refit the panels in the reverse order in which they were removed.
6. Reposition the internal glass panel. Take care to centre and insert the 4 pins into their housings in the oven door by applying slight pressure.

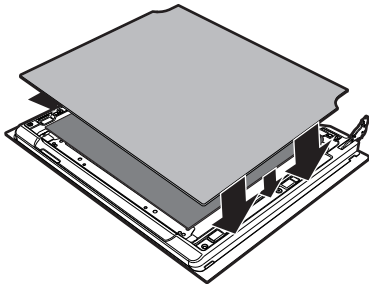

## 4.8 Cleaning the inside of the oven

For the best oven upkeep, clean it regularly after having allowed it to cool.

Take out all removable parts.

Clean the oven racks with warm water and non-abrasive detergent. Carefully rinse and dry the damp parts.

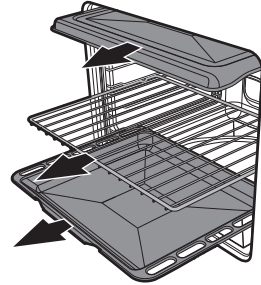

The oven should be operated at the maximum temperature for about 15-20 minutes after the use of specific products, to burn off the residues left inside the oven.



For easier cleaning, remove the door.



## Cleaning and maintenance

### Removing racks/trays support frames

Removing the guide frames enables the sides to be cleaned more easily. This operation should be performed each time the automatic cleaning cycle is used (on some models only).

To remove the guide frames: Pull the frame towards the inside of the oven to unhook it from its groove **A**, then slide it out of the seats **B** at the back.

When cleaning is complete, repeat the above procedures to put the guide frames back in.

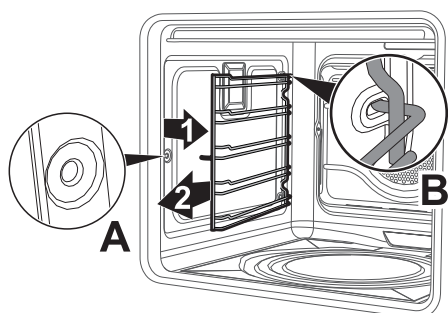

### 4.9 Vapor Clean: assisted oven cleaning (on some models only)



Vapor Clean is an assisted cleaning procedure which facilitates the removal of dirt. Thanks to this process, it is possible to clean the inside of the oven very easily. The dirt residues are softened by the heat and water vapour for easier removal afterwards.



**Improper use**  
**Risk of damage to surfaces**

- Remove any food residues or large spills from previous cooking operations from the inside of the oven.
- Carry out assisted oven cleaning operations only when the oven is cold.

### Preliminary operations

Before starting the Vapor Clean function:

- Completely remove all accessories from inside the oven. The upper guard can be left inside the oven.
- Pour approx. 40 cc of water onto the floor of the oven. Make sure it does not overflow out of the cavity.

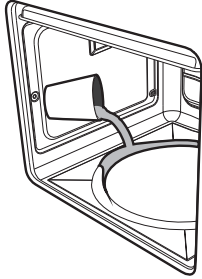

- Spray a water and washing up liquid solution inside the oven using a spray nozzle. Direct the spray against the side walls, upwards, downwards and towards the deflector.

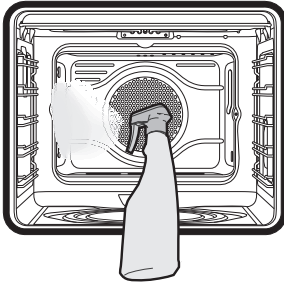

- Close the door.



We recommend spraying approx. 20 times at the most.

4. At the end of the Vapor Clean cycle, the timer will deactivate the oven heating elements, the buzzer will start to sound and the numbers on the dial will flash.

## End of the Vapor Clean cycle

5. Open the door and wipe away the less stubborn dirt with a microfibre cloth.
6. Use an anti-scratch sponge with brass filaments on tougher encrustations.
7. In case of grease residues use specific oven cleaning products.
8. Remove the water left inside the oven.
9. For improved hygiene and to avoid food being affected by any unpleasant odours, we recommend that the oven is dried using a fan-assisted function at 160°C for approximately 10 minutes.



We recommend wearing rubber gloves for these operations.



For easier manual cleaning of the parts difficult to reach, we recommend removing the door.

## Vapor Clean setting

1. Turn the function knob and the temperature knob to the  symbol.
2. Set a cooking time of 18 minutes using the cooking time procedure described in more detail in "Programmed cooking";
3. The Vapor Clean cycle starts approximately 6 seconds after the last pressure on the programmer's keys.



## Cleaning and maintenance

### 4.10 Pyrolysis: automatic oven cleaning (on some models only)



Pyrolysis is an automatic high-temperature cleaning procedure which causes dirt to dissolve. Thanks to this process, it is possible to clean the inside of the oven very easily.



#### Improper use Risk of damage to surfaces

- Remove any food residues or large spills from previous cooking operations from the inside of the oven.
- Switch off the burners or electric hot plates of the hob installed above the oven.





#### Preliminary operations

Before starting the pyrolysis cycle:

- Clean the internal glass panel following the usual cleaning instructions.
- For very stubborn encrustations spray an oven cleaning product onto the glass (read the warnings on the product); leave for 60 minutes, then rinse and dry the glass using kitchen roll or a microfibre cloth.
- Completely remove all accessories from inside the oven.

- Remove the racks/trays support frames.
- Remove the upper guard (where present).
- Close the door.

#### Pyrolysis setting

1. Turn the function knob to symbol  or .
2. Press the temperature knob to start the pyrolysis cycle. The  indicator light comes on.
3. Turn the temperature knob to the right or to the left to set the cleaning cycle duration from a minimum of 2 hours to a maximum of 3 hours (except for the  function whose duration is 120 minutes).
4. Press the temperature knob to start the pyrolysis cycle.



Recommended pyrolysis duration:

- Light dirt: 120 minutes.
- Medium dirt: 150 minutes.
- Heavy dirt: 180 minutes.





## Pyrolysis

- The display shows "Pyro" to indicate that the appliance is carrying out the automatic cleaning cycle.
- Two minutes after the pyrolysis cycle has started the door is locked (the door lock indicator light  comes on) by a device that prevents the door from being opened.



**i** It is not possible to select any function once the door locking device has been activated.

- Press the temperature knob to display the time remaining to the end of the pyrolysis cycle.



- At the end of the pyrolysis cycle, the door remains locked as long as the temperature inside the oven returns to safety levels. Wait for the oven to cool down and collect the residues deposited inside with a damp microfibre cloth.



**i** During the first pyrolysis cycle, unpleasant odours may occur due to the normal evaporation of oily manufacturing substances. This is an absolutely normal phenomenon which disappears after the first pyrolysis.

**i** During the pyrolysis cycle the fans produce a more intense level of noise due to a greater rotation speed. This is an absolutely normal operation, intended to provide more effective heat dispersal. At the end of the pyrolysis cycle, the fans will continue to operate for long enough to avoid overheating the walls of adjacent units and the front of the oven.

 If the pyrolysis gives unsatisfactory results at minimum duration, it is recommended to set a longer time for successive cleaning cycles.

## Setting of programmed pyrolysis

It is possible to program the pyrolysis start time.

- After selecting the pyrolysis cycle duration, press the temperature knob. The display shows the current time and the  indicator light comes on.
- Turn the temperature knob to set the time at which you wish to terminate the pyrolysis cycle.
- After a few seconds, the  and  indicator lights remain lit steadily and the appliance waits for the set start time to start the cleaning cycle.

**i** It is not possible to select any function once the door locking device has been activated.



# Cleaning and maintenance

## 4.11 Extraordinary maintenance



Live parts  
**Danger of electrocution**

- Disconnect the oven power supply.

### Replacing the internal light bulb

1. Completely remove all accessories from inside the oven.
2. Remove the racks/trays support frames.
3. Remove the bulb cover using a tool (e.g. a screwdriver).

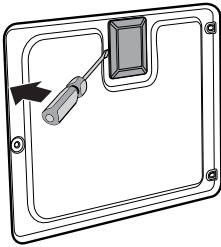

### Incandescent lamps:

4. Unscrew and remove the lamp.

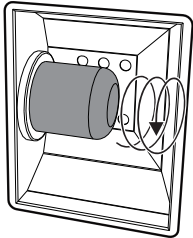

5. Replace the lamp with one of the same type (25W).

6. Refit the cover correctly, so that the moulded part of the glass is facing the door.
7. Press the cover completely down so that it attaches perfectly to the bulb support.

### Halogen lamps:

8. Slide out and remove the lamp.

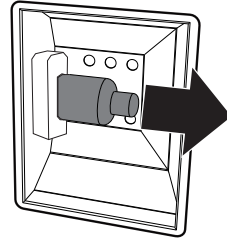

Do not touch the halogen lamp directly with your fingers, but wrap it in an insulating material.

9. Replace the lamp with one of the same type (40W).
10. Refit the cover correctly, so that the moulded part of the glass is facing the door.
11. Press the cover completely down so that it attaches perfectly to the bulb support.



## Removing the door seal (not on pyrolytic models)

To permit thorough cleaning of the oven, the door seal may be removed. There are fasteners on all four sides to attach it to the edge of the oven. Pull the 4 edges of the seal outwards to detach the fasteners.

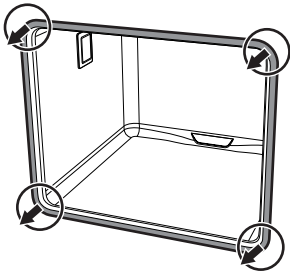

## What to do if...

The display is completely off:

- Check the mains power supply.
- Check whether an omnipolar switch upstream of the appliance supply line is in the "ON" position.

The appliance does not heat up:

- Check whether it has been set in "showroom" mode (for further details see "Secondary menu").

The controls do not respond:

- Check whether it has been set in "child lock" mode (for further details see "Secondary menu").

The cooking times are longer than those indicated in the table:

- Check whether it has been set in "low power" mode (for further details see "Secondary menu").

After the automatic cleaning cycle (pyrolysis) it is not possible to select a function:

- Verify whether the door locking device has deactivated. If it has not, the oven has a safety device that does not allow functions to be selected while the door locking device is active. This is because the temperature inside the oven is still too high to permit any type of cooking.

The display shows "ERR4":

- The door lock has not properly attached to the door. This might be because the door was accidentally opened during the door lock activation. Switch the oven off and on again, waiting a few minutes before selecting a new cleaning cycle.

If the door is opened during a fan-assisted function, the fan stops:

- This is not a fault. It is a normal operation of the appliance, useful when cooking foods in order to avoid excessive heat escaping. When the door is closed, the oven will return to normal operation.



If the problem has not been resolved or in the case of other types of fault, contact your local technical support centre.



# Installation

## 5 Installation

### 5.1 Electrical connection



**Power voltage**  
**Danger of electrocution**

- Have the electrical connection performed by authorised technical personnel.
- The appliance must be connected to earth in compliance with electrical system safety standards.
- Disconnect the main power supply.

#### General information

Check the grid characteristics against the data indicated on the plate.

The identification plate bearing the technical data, serial number and brand name is visibly positioned on the appliance.

Do not remove this plate for any reason.

The appliance works at 220-240 V~.

Use a H05V2V2-F type three-core cable (3 x 1.5 mm<sup>2</sup> cable, referring to the cross section of the internal conductor).

Perform the ground connection using a wire that is 20 mm longer than the other wires.

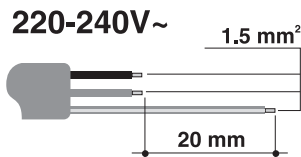

#### Fixed connection

Fit the power line with an omnipolar circuit breaker in compliance with installation regulations.

The circuit breaker should be located near the appliance and in an easily reachable position.

#### Connection with plug and socket

Make sure that the plug and socket are of the same type.

Avoid using adapters and shunts as these could cause overheating and a risk of burns.

### 5.2 Cable replacement



**Power voltage**  
**Danger of electrocution**

- Disconnect the main power supply.

1. Unscrew the rear casing screws and remove the casing to access the terminal board.

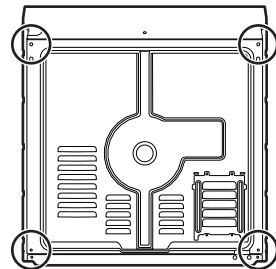

2. Replace the cable.
3. Make sure that the cables (for the oven or any hob) follow the best route in order to avoid any contact with the appliance.



## 5.3 Positioning



**Heavy appliance  
Danger of crush injuries**

- Place the appliance into the piece of furniture with the aid of a second person.



**Pressure on the open door  
Risk of damages to the appliance**

- Never use the oven door to lever the appliance into place when fitting.
- Avoid exerting too much pressure on the oven door when open.



**Heat production during appliance operation  
Risk of fire**

- Check that the piece of furniture material is heat resistant.
- Check that the piece of furniture has the required slots.

### Fastening bushings

Remove the bushing covers inserted on the oven front.

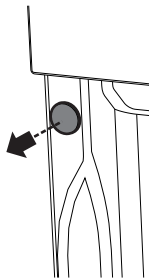

Mount the appliance into the recess.

Secure the appliance to the piece of furniture using screws.

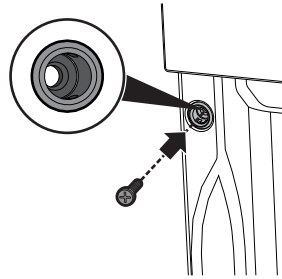

Cover the bushings with the covers removed previously.

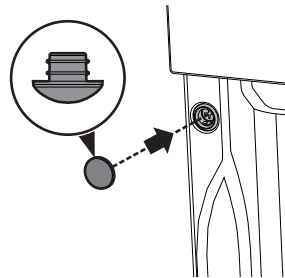

### Appliance overall dimensions (mm)

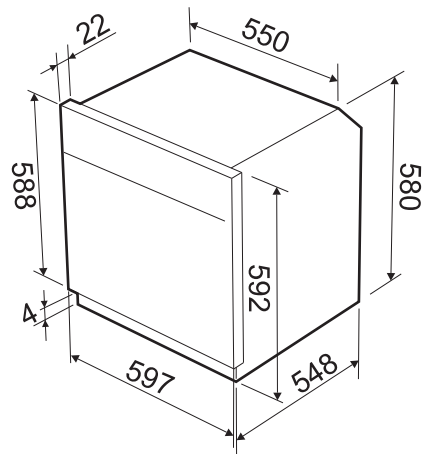



# Installation

## Mounting under worktops (mm)

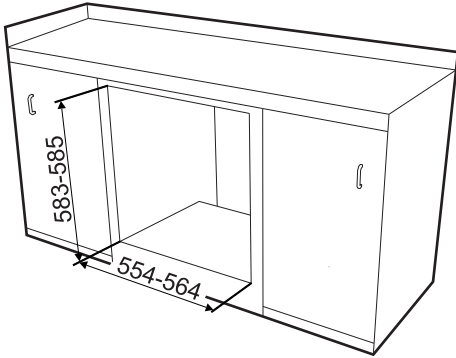

## Mounting into a column (mm)

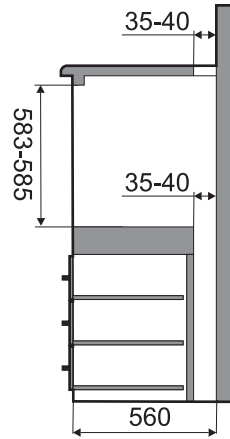
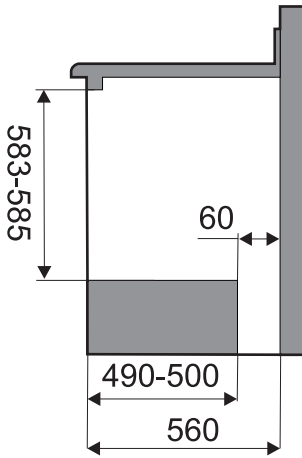
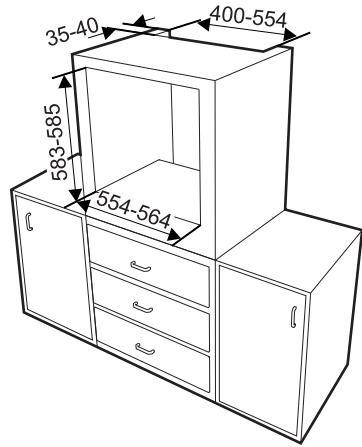

Make sure that the piece of furniture rear/bottom part has an opening of approx. 60 mm.



Make sure that the piece of furniture top/rear part has an opening approx. 35-40 mm deep.





914775289/A