

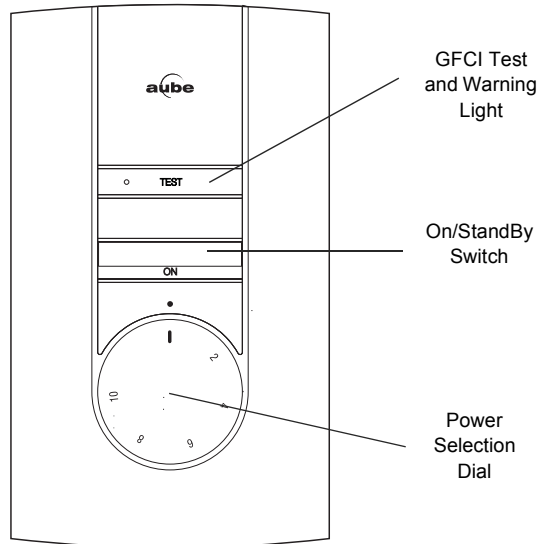

TH113-R Regulator

User Guide



Introduction

Thank you for choosing Aube's TH113-R Regulator.

The TH113-R is specially designed to control a floor heating installation, a baseboard or a convector.

The TH113-R regulator operates like a dimmer switch to allow you to easily adjust the amount of power sent to your heating system.

It features an integrated GFCI, and includes a test button and warning light for added security.

This regulator is also equipped with an ON/STANDBY switch making it possible to put it in sleep mode when its use is not required (e.g. summer).

IMPORTANT!

The GFCI and Remote Input options are not available with a low voltage power base. Skip sections 3 and 4.

1 Control Module Installation

Align the bracket tabs on the regulator with the holes located on the power base.

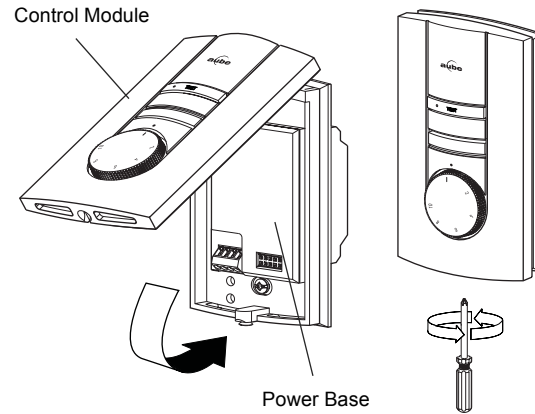

- ▶ This regulator must be installed on a PB112 power base.
- ▶ The screw cannot be removed completely.
- ▶ Keep the regulator's air vents clean and free from obstructions.

2 Operation

The TH113-R regulator operates on perpetual 15-minute heating cycles.

For example, if the dial is set halfway, the system will heat for 50% of the cycle; it will be ON for 7.5 minutes and OFF for 7.5 minutes.

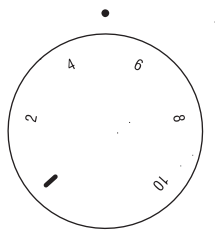

Below is a detailed table of the cycle duration based on the dial's position:

Position and equivalent %	1 0%	2 20%	4 40%	6 60%	8 80%	10 100%
ON	0 min	3 min	6 min	9 min	12 min	15 min
OFF	15 min	12 min	9 min	6 min	3 min	0 min

NOTE: Depending on the power base used, the heating cycles can be 15 seconds or 15 minutes.

3 GFCI Test (GA/GB line power base only)

The GFCI monitors the electrical flow for any loss of current; if there is any loss, the thermostat will cut off power to the heating system.

We recommend you test the GFCI immediately after installing the control module, and once a month thereafter to ensure it is operating properly.

To test:

1 Press the TEST button:

• **Successful:** TEST warning light is ON and power to heating system is cut off.

• **Unsuccessful:** TEST warning light is OFF.

✘ Cut power to heating system from the main power panel and call customer service.

2 When successful, reset thermostat (STANDBY/ON) to power heating system.

NOTE: If the test warning light comes ON during normal operation, cut power to heating system from the main power panel and have an electrician verify the installation.

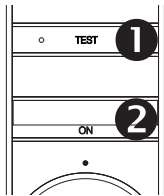

4 Remote Input (line voltage only)

When a remote control interface (Aube CT241 or any other remote control system) is connected to the power base's remote input and a signal is received, the TH113-R module automatically lowers the percentage by 35% based on the dial's current position.

The LED lights up to indicate the signal's presence (except for GA and GB models).

Signal temporary bypass

The TEST button can be used to bypass the signal for a 2-hour period.

The LED goes off to indicate the bypass.

NOTE: When combined with a GA or GB power base, the TEST button is used only for GFCI testing. The percentage is decreased, but the bypass function and indicator are not available.

Technical Specifications

Model: TH113-R

Power setting range: 0 to 100%

Storage: -20°C to 50°C (-4°F to 120°F)

Warranty

AUBE TECHNOLOGIES INC. ONE (1) YEAR LIMITED WARRANTY

This product is guaranteed against workmanship defects for a one year period following the initial date of purchase. During this period, AUBE Technologies Inc. will repair or replace, at our option and without charge, any defective product which has been used under normal conditions.

The warranty does not cover delivery costs and does not apply to products poorly installed or randomly damaged following installation. This warranty cancels and replaces any other manufacturer's express or implied warranty as well as any other company commitment.

AUBE Technologies Inc. cannot be held liable for related or random damages following the installation of this product. The defective product as well as the purchase invoice must be returned to the place of purchase or mailed, prepaid and insured, to the following address:

Aube Technologies Inc.
705 Montrichard
Saint-Jean-sur-Richelieu, Quebec, Canada J2X 5K8

If you have any questions concerning the TH113-R Regulator, call our technical support team at:

Phone: Montreal area: (450) 358-4600
Canada / U.S.: 1-800-831-AUBE (2823)

Fax: (450) 358-4650

Email: service@aubetech.com

Monday to Friday from 8:30 AM to 5:00 PM EST.

For more information on our products, visit us at:
www.aubetech.com

1 Applications

The PB112-024T-15S power base can be used on any TH11x series thermostat (with the exception of the TH110 model). This low-voltage power base operates on 15-second cycles and can be connected to a line-voltage load using a solid-state relay. The PB112-024T-15S is compatible with most solid-state relays; however, the following Aube relays are optimized for use with this power base:

- RT850 solid-state relay (SSR)
- RT850T solid-state relay (SSR) with built-in 24-V transformer

WARNING

This power base **MUST** be used **ONLY** with solid-state relays. The use of electromechanical relays will result in reduced life expectancy and in the possibility of overheating of these devices.

2 Supplied Parts

- 1 One (1) power base
- 2 Two (2) plastic anchors
- 3 Two (2) mounting screws

3 Installation Guidelines

- ▶ For a new installation, choose a location about 1.5 m (5 ft.) above the floor.
- ▶ The thermostat must be installed on an inside wall facing the heating system (except for floor heating systems).
- ▶ Avoid locations where there are air drafts (top of staircase, air outlet), dead air spots (behind a door), direct sunlight or concealed chimney or stove pipes (except for floor heating systems).

4 Installation Procedure

The installation must be carried out by an electrician and comply with local electrical codes.

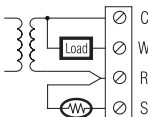
- 1 Turn off power to the heating system at the main electrical panel to avoid electrical shock.
- 2 Wire the base according to your application. See typical wiring diagrams in sections 4.1 and 4.2.
- 3 For a floor heating system installation, connect the floor sensor between the S and R terminals.
 
- 4 Secure the base to the wall using the provided screws and wall anchors.
- 5 Configure the switches located on the control module (if any). Refer to the user guide.

- 6 Install the control module onto the base.
- 7 Apply power to the heating system.
- 8 Verify the installation by checking that the heating system can be turned on or off using the thermostat.

4.1 Single SSR with Built-in Transformer

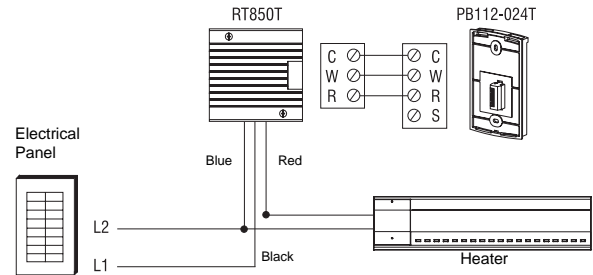

4.2 Multiple SSRs with External Transformer

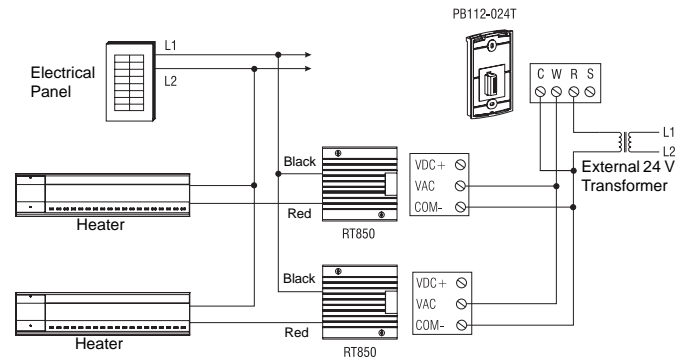

5 Technical Specifications

Maximum load: 0.5 A / 24 VAC

Heating cycle length: 15 seconds

Operating temperature: 32°F to 122°F (0°C to 50°C)

Storage: -4°F to 122°F (-20°C to 50°C)

Size (H • W • D): 124 x 70 x 23 mm (4.89 x 2.76 x 0.91 in)

Wire gauge: 14 to 22 AWG