



AXIOMTEK

rBOX310-FL Series

**Robust Din-rail Fanless Embedded
System**

User's Manual



Disclaimers

This manual has been carefully checked and believed to contain accurate information. Axiomtek Co., Ltd. assumes no responsibility for any infringements of patents or any third party's rights, and any liability arising from such use.

Axiomtek does not warrant or assume any legal liability or responsibility for the accuracy, completeness or usefulness of any information in this document. Axiomtek does not make any commitment to update the information in this manual.

Axiomtek reserves the right to change or revise this document and/or product at any time without notice.

No part of this document may be reproduced, stored in a retrieval system, or transmitted, in any form or by any means, electronic, mechanical, photocopying, recording, or otherwise, without the prior written permission of Axiomtek Co., Ltd.

©Copyright 2013 Axiomtek Co., Ltd.

All Rights Reserved

December 2013, Version A1

Printed in Taiwan

Safety Precautions

Before getting started, please read the following important safety precautions.

1. The rBOX310-FL does not come equipped with an operating system. An operating system must be loaded first before installing any software into the computer.
2. Be sure to ground yourself to prevent static charge when installing the internal components. Use a grounding wrist strap and place all electronic components in any static-shielded devices. Most electronic components are sensitive to static electrical charge.
3. Disconnect the power cord from the rBOX310-FL before making any installation. Be sure both the system and the external devices are turned OFF. Sudden surge of power could ruin sensitive components. Make sure the rBOX310-FL is properly grounded.
4. Make sure the voltage of the power source is correct before connecting the equipment to the power outlet.
5. Turn OFF the system power before cleaning. Clean the system using a cloth only. Do not spray any liquid cleaner directly onto the screen.
6. Do not leave this equipment in an uncontrolled environment where the storage temperature is below -45°C or above 85°C . It may damage the equipment.
7. Do not open the system's back cover. If opening the cover for maintenance is a must, only a trained technician is allowed to do so. Integrated circuits on computer boards are sensitive to static electricity. To avoid damaging chips from electrostatic discharge, observe the following precautions:
 - Before handling a board or integrated circuit, touch an unpainted portion of the system unit chassis for a few seconds. This will help to discharge any static electricity on your body.
 - When handling boards and components, wear a wrist-grounding strap, available from most electronic component stores.

Classification

1. Degree of protection against electric shock: not classified
2. Degree of protection against the ingress of water: IP30
3. Equipment not suitable for use in the presence of a flammable anesthetic mixture with air or with oxygen or nitrous oxide.
4. Mode of operation: Continuous
5. Type of protection against electric shock: Class I equipment

General Cleaning Tips

You may need the following precautions before you begin to clean the computer. When you clean any single part or component for the computer, please read and understand the details below fully.

When you need to clean the device, please rub it with a piece of dry cloth.

1. Be cautious of the tiny removable components when you use a vacuum cleaner to absorb the dirt on the floor.
2. Turn the system off before you start to clean up the component or computer.
3. Never drop the components inside the computer or get circuit board damp or wet.
4. Be cautious of all kinds of cleaning solvents or chemicals when you use it for the sake of cleaning. Some individuals may be allergic to the ingredients.
5. Try not to put any food, drink or cigarette around the computer.

Cleaning Tools

Although many companies have created products to help improve the process of cleaning your computer and peripherals users can also use household items to clean their computers and peripherals. Below is a listing of items you may need or want to use while cleaning your computer or computer peripherals.

Keep in mind that some components in your computer may only be able to be cleaned using a product designed for cleaning that component, if this is the case it will be mentioned in the cleaning.

- Cloth: A piece of cloth is the best tool to use when rubbing up a component. Although paper towels or tissues can be used on most hardware as well, we still recommend you to rub it with a piece of cloth.
- Water or rubbing alcohol: You may moisten a piece of cloth a bit with some water or rubbing alcohol and rub it on the computer. Unknown solvents may be harmful to the plastics parts.
- Vacuum cleaner: Absorb the dust, dirt, hair, cigarette particles, and other particles out of a computer can be one of the best methods of cleaning a computer. Over time these items can restrict the airflow in a computer and cause circuitry to corrode.
- Cotton swabs: Cotton swabs moistened with rubbing alcohol or water are excellent tools for wiping hard to reach areas in your keyboard, mouse, and other locations.
- Foam swabs: Whenever possible it is better to use lint free swabs such as foam swabs.



Note: *We strongly recommended that you should shut down the system before you start to clean any single components.*

Please follow the steps below:

1. Close all application programs
2. Close operating software
3. Turn off power
4. Remove all device
5. Pull out power cable

Scrap Computer Recycling

If the computer equipments need the maintenance or are beyond repair, we strongly recommended that you should inform your Axiomtek distributor as soon as possible for the suitable solution. For the computers that are no longer useful or no longer working well, please contact your Axiomtek distributor for recycling and we will make the proper arrangement.

Trademarks Acknowledgments

Axiomtek is a trademark of Axiomtek Co., Ltd. IBM, PC/AT, PS/2, VGA are trademarks of International Business Machines Corporation.

Intel[®] and Pentium[®] are registered trademarks of Intel Corporation.

MS-DOS, Microsoft C and QuickBASIC are trademarks of Microsoft Corporation.

VIA is a trademark of VIA Technologies, Inc.

SST is a trademark of Silicon Storage Technology, Inc.

UMC is a trademark of United Microelectronics Corporation. Other brand names and trademarks are the properties and registered brands of their respective owners.

Table of Contents

| | |
|--|-----------|
| Safety Precautions | iii |
| Classification | iv |
| General Cleaning Tips..... | iv |
| Scrap Computer Recycling | vi |
| CHAPTER 1 INTRODUCTION | 1 |
| 1.1 General Description | 1 |
| 1.2 System Specifications | 3 |
| 1.2.1 CPU | 3 |
| 1.2.2 Chipset..... | 3 |
| 1.2.3 BIOS | 3 |
| 1.2.4 System Memory | 3 |
| 1.2.5 Display | 3 |
| 1.2.6 Ethernet Ports | 4 |
| 1.2.7 Storages..... | 4 |
| 1.2.8 USB | 4 |
| 1.2.9 COM..... | 5 |
| 1.2.10 Two power paths | 6 |
| 1.2.11 WatchDog Timer (WDT)..... | 6 |
| 1.2.12 Audio | 7 |
| 1.2.13 System LED | 7 |
| 1.2.14 Alarm Contact..... | 9 |
| 1.2.15 Mini Card..... | 12 |
| 1.2.16 Reset Bottom..... | 12 |
| 1.2.17 Operation Temperature | 12 |
| 1.2.18 Storage Temperature..... | 12 |
| 1.2.19 Humidity..... | 12 |
| 1.2.20 Weight | 12 |
| 1.2.21 Dimensions..... | 12 |
| 1.2.22 System I/O Outlets | 13 |
| 1.3 Dimensions | 14 |
| 1.4 I/O Outlets | 15 |
| CHAPTER 2 HARDWARE INSTALLATION | 17 |
| 2.1 Installing the Memory Module..... | 17 |
| 2.2 Installing the Hard Disk Drive | 22 |
| 2.3 Installing Din-rail Mounting..... | 26 |
| 2.4 Installing Wall Mounting (optional)..... | 34 |
| CHAPTER 3 AMI UEFI BIOS UTILITY | 37 |
| 3.1 Entering Setup | 37 |
| 3.2 The Main Menu | 37 |
| 3.3 Advanced Features | 39 |
| 3.4 Chipset Feature..... | 54 |
| 3.5 Boot Type | 55 |
| 3.6 Security..... | 60 |

3.7 Save & Exit 63

CHAPTER 1

INTRODUCTION

This chapter contains general information and detailed specifications of the rBOX310-FL. The Chapter 1 includes the following sections:

- General Description
- System Specification
- Dimensions
- I/O Outlets

1.1 General Description

The rBOX310-FL Din-rail fanless embedded systems are suitable for communications control and for protocol converter applications in critical environments. Built for rugged work environments, the rBOX310-FL series features an extra low power consumption Intel[®] ATOM[™] N2800 (1.86 GHz) processors supporting industrial temperature range of -40°C to +70°C. Their front accessible I/O cabling is very convenient for wiring and maintenance. The rBOX310-FL series offers a VGA output, making it particularly well-suited for communication control, SCADA and industrial automation. Its compact size with Din-rail mounting allows for easy installation into control cabinet. Pre-installed with Linux, Windows[®] 7 embedded, the rBOX310-FL series provides programmers with a friendly environment for developing application software at a lower cost.

The rBOX310-FL is robust industrial-grade hardware design and adopts the advanced cooling system, besides, supporting the CompactFlash[™], which makes it especially suitable for field control & monitoring system solution for following markets:

Utility Industries (Water; Energy; Chemical Plant; Mining...)

Public Transportation Industries (Traffic/ Highway Control; Train/Bus Control...)

Homeland Security (Weather Monitoring/Alarm System...)

● Features

- Fanless and no internal cabling design
- Wide temperature operation of -40°C - +70°C
- Supports 2 10/100/1000 Ethernets with Magnetic Isolation Protection
- 4 COM Ports
- 2 Watchdog Timers
- LED Indicators (Power, Alarm, Ready/Active, COM...)
- Mini Card (3G/GPRS or Wifi)
- Audio(Line in & Line out)
- SNMP V1/V2c
- Support one 2.5" SATA SSD (or HDD) and one CompactFlash[™]
- 2 power paths with terminal block and 12–48VDC
- Din-rail mounting

- Wall mounting (optional)
- Passed heavy industrial CE with FCC Part 18 testing

- **Embedded O.S. Supported**

The rBOX310-FL not only supports Windows[®] 7, but also supports embedded OS, such as Windows[®] 7 embedded and Linux package support. For storage device, the rBOX310-FL supports one SATA SSD or HDD and one type II CompactFlash[™] slot.

- **Intelligent AXView & SNMP V1/V2c**

The rBOX310 features SNMP V1/V2c support for secured network management. To streamline implementation of management applications, Axiomtek has launched exclusive “AXView” monitoring software package for customers to build their own management systems easily and quickly. Axiomtek AXView also contains a variety of easy-to-use management utilities, agent services and libraries. For more product information, please visit our global website on Axiomtek AXView

<http://axiomtek.com/products/ViewProduct.asp?view=1001>

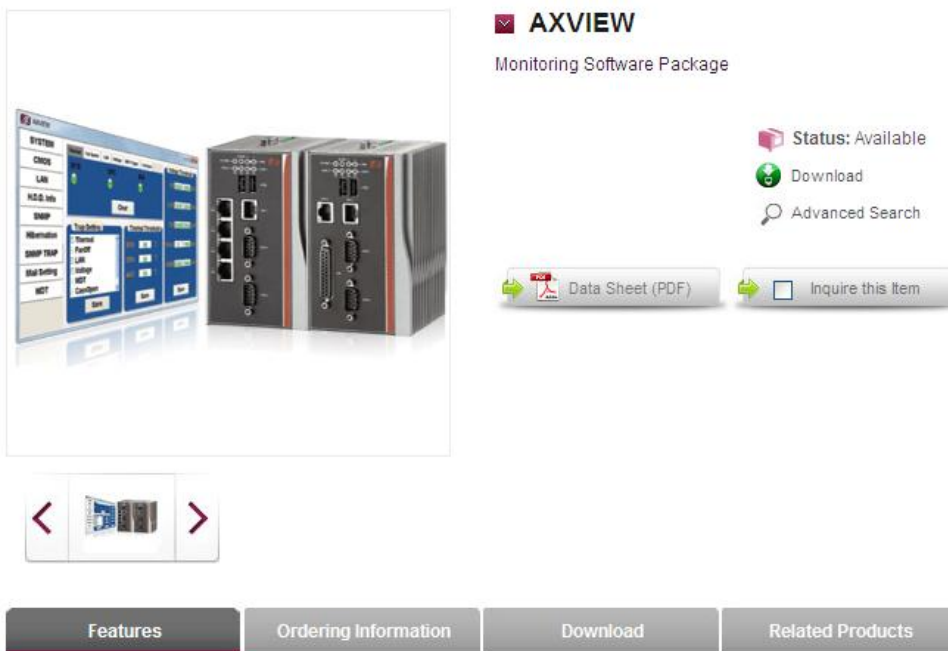

AXVIEW
Monitoring Software Package

Status: Available
Download
Advanced Search

Data Sheet (PDF) Inquire this Item

Features Ordering Information Download Related Products

1.2 System Specifications

1.2.1 CPU

- Onboard Intel® ATOM™ dual core N2800 (1.86 GHz) processors.

1.2.2 Chipset

- Intel® System Controller NM10.

1.2.3 BIOS

- AMI (American Megatrends Inc.) UEFI (Unified Extensible Firmware Interface) BIOS.

1.2.4 System Memory

- One 204-pin SO-DIMM supports up to 4GB DDR3 800/1066MHz.
- The composition of Memory can't support 4Gb and 8Gb by Intel Atom Cedar Trail specification limitation.

1.2.5 Display

- Intel GMA3600 graphics Core integrate in CPU
- A slim type 15-pin D-Sub connector as VGA connector
- VGA IO Pin Define :

| Pin | Signal | Pin | Signal | Pin | Signal |
|-----|-----------------|-----|---------------|-----|----------|
| 1 | Red | 2 | Green | 3 | Blue |
| 4 | N.C. | 5 | GND | 6 | GND |
| 7 | GND | 8 | GND | 9 | VCC |
| 10 | GND | 11 | N.C. | 12 | DDC DATA |
| 13 | Horizontal Sync | 14 | Vertical Sync | 15 | DDC CLK |

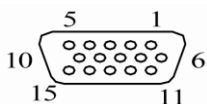

1.2.6 Ethernet Ports

- LAN 1 and LAN 2

The board has dual RJ-45 ethernet connector which using Intel i210-IT ethernet controllers, support 1000/100/10-Base transmit rate and with 1.5KV magnetic isolation protection.

| Pin | Signal |
|-----|--|
| L1 | MDI0+ |
| L2 | MDI0- |
| L3 | MDI1+ |
| L4 | MDI1- |
| L5 | MDI2+ |
| L6 | MDI2- |
| L7 | MDI3+ |
| L8 | MDI3- |
| A | Active LED (Yellow) |
| B | Speed LED 1000-Base-T (Amber) 100-Base-T (Green) 10-Base-T (Dark) |

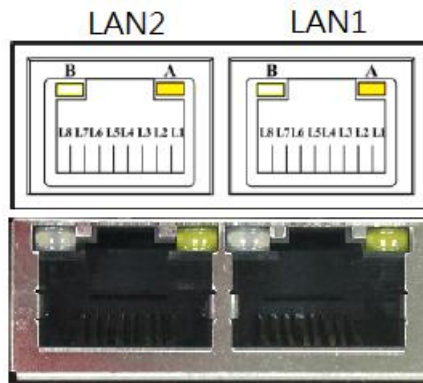

1.2.7 Storages

- 1 x 2.5" SATA SSD (or HDD) drive bay
- 1 x CompactFlash Typell slot (easy-to- access)

1.2.8 USB

- 2 x USB2.0
- With power distribution control and over current protection
- USB Pin Define :

| Pin | Signal USB Port 0 | Pin | Signal USB Port 1 |
|-----|----------------------|-----|----------------------|
| 1 | VCC | 5 | VCC |
| 2 | D- | 6 | D- |
| 3 | D+ | 7 | D+ |
| 4 | GND | 8 | GND |

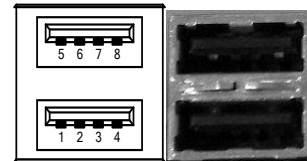

- USB power (5V) distribution control.
Some program and sample code for USB power distribution control are offered in Windows and Linux.
 - Windows: Please refer it from our Axiomtek AXView which on [Axiomtek's website](#) directly.
 - Linux : Please refer it from our [Axiomtek's website](#) directly.

1.2.9 COM

- 4 ports DB9 Pin support RS-232/422/485
- With ESD Protection 15KV
- COM1,COM2 speed up to 115.2kbps
- COM3,COM4 speed up to 921.6kbps
- rBOX support jumper less design. All of the COM port interface RS232/422/485 can be selected by BIOS menu or software program.
- It also supports Auto Flow Control in RS485 mode
- Serial Port Pin Define : (DB9 Male)

COM1/COM2

| Pin | RS-232 | RS-422 | RS-485 |
|-----|--------|--------|--------|
| 1 | DCD | TX- | Data- |
| 2 | RXD | TX+ | Data+ |
| 3 | TXD | RX+ | -- |
| 4 | DTR | RX- | -- |
| 5 | GND | GND | GND |
| 6 | DSR | -- | -- |
| 7 | RTS | -- | -- |
| 8 | CTS | -- | -- |
| 9 | RI | -- | -- |

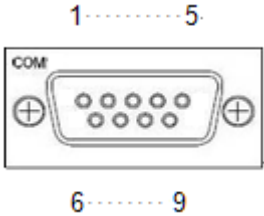

COM3/COM4

Doesn't support RI signal

| Pin | RS-232 | RS-422 | RS-485 |
|-----|--------|--------|--------|
| 1 | DCD | TX- | Data- |
| 2 | RXD | TX+ | Data+ |
| 3 | TXD | RX+ | -- |
| 4 | DTR | RX- | -- |
| 5 | GND | GND | GND |
| 6 | DSR | -- | -- |
| 7 | RTS | -- | -- |
| 8 | CTS | -- | -- |
| 9 | N/A | -- | -- |

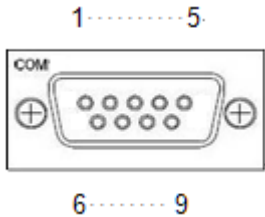

- Some program and sample code for COM port interface type are offered in Windows and Linux.
 - Windows: Please refer it from our Axiomtek AXView which on [Axiomtek's website](#) directly.
 - Linux : Please refer it from our [Axiomtek's website](#) directly.

1.2.10 Two power paths

- Two DC input power sources must be same and range between 12-48V.
- Main power source is PWR1, Backup power source is PWR2.
- When only one power source must connect to PWR1.
- DC Inputs have UVP,OVP and Reverse protection.
- DC Terminal Block

| Pin | Signal |
|-----|---------------|
| 1 | Alarm- |
| 2 | Alarm+ |
| 3 | Shield Ground |
| 4 | Shield Ground |
| 5 | - |
| 6 | + PWR2 |
| 7 | - |
| 8 | + PWR1 |

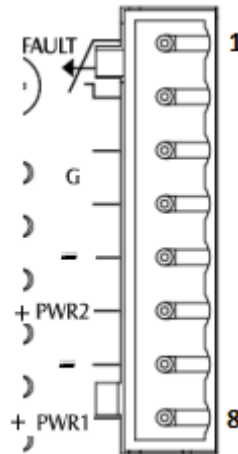

Note: If 2 power sources aren't same voltage and the system will be possible damage.

1.2.11 WatchDog Timer (WDT)

- rBOX310 support two Watchdog timers. Those can cause system reset when timer expired.
- WDT 1 : one step is 1sec or 1min, 255 levels
WDT 2 : one step is 250ms, 255 levels
- Some program and sample code for two Watchdog timers are offered in Windows and Linux.
 - Windows: Please refer it from our Axiomtek AXView which on [Axiomtek's website](#) directly.
 - Linux : Please refer it from our [Axiomtek's website](#) directly.

1.2.12 Audio

There are two audio jacks for Line in and Line out

| Signal |
|------------------|
| Line out (Green) |
| Line in (Blue) |



1.2.13 System LED

There are showed the LED's indicators and functional descriptions.

| LED Name | Description | Color |
|-------------------|--|--------|
| PWR1 | Indicate the PWR1 input status. When the DC input is acceptable, the LED will ON. | Green |
| PWR2 | Indicate the PWR2 input status. When the DC input is acceptable, the LED will ON. | Green |
| Alarm | The LED will ON if having below condition. 1. DC PWR1 or PWR2 is lost. (default) 2. User define event. Notice: The behavior of Alarm and Relay are the same. When the LED of Alarm is ON and the Relay will be turn on at the same time. | Red |
| ACT/RDY | The LED for RDY/ACT can help users to judge BIOS finish or not and the OS can normal work or not. When the BIOS finish the configuration of system, the LED will ON. After this the LED will flash when the storage is accessed. - The LED will flash when the storage is accessed. - The LED isn't ON for a long time, it means the system is on shutdown status. | Yellow |
| ANT ACT | When ANT accessed data the LED will flash. | Green |
| Storages Accessed | When storages accessed data the LED will flash. | Green |



| LED Name | Description | Color |
|----------|--|-------|
| COM1 TX | When COM1 transmit data the LED will on. | Green |
| COM1 RX | When COM1 receive data the LED will on. | Green |
| COM2 TX | When COM2 transmit data the LED will on. | Green |
| COM2 RX | When COM2 receive data the LED will on. | Green |
| COM3 TX | When COM3 transmit data the LED will on. | Green |
| COM3 RX | When COM3 receive data the LED will on. | Green |
| COM4 TX | When COM4 transmit data the LED will on. | Green |
| COM4 RX | When COM4 receive data the LED will on. | Green |

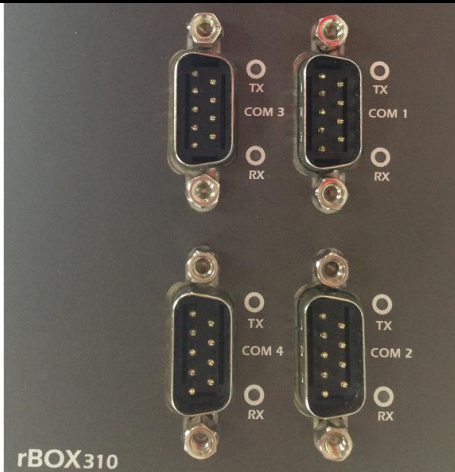

- Some program and sample code for Alarm LED and Relay Output are offered in Windows and Linux
 - Windows: Please refer it from our Axiomtek AXView which on [Axiomtek's website](#) directly.
 - Linux : Please refer it from our [Axiomtek's website](#) directly.

1.2.14 Alarm Contact

- rBOX310 support two DC power path. When lost one of them will cause Alarm LED on and trigger Relay out to remote notice.
- We also provide the register for user to define their event for trigger the Alarm LED and Relay. Alarm LED and Relay output have the same activity depend on DC status and register control.
- 1 relay output.
- Event : Power Fail or User define.
- Some program and sample code for Alarm LED and Relay Output are offered in Windows and Linux.
 - Windows: Please refer it from our Axiomtek AXView which on [Axiomtek's website](#) directly.
 - Linux : Please refer it from our [Axiomtek's website](#) directly.
- rBOX Alarm Application:

Troubleshooting is very important in many applications.

In the rBOX series we can provide three kinds of way for troubleshooting.

- Alarm LED
- Relay out
- SNMP through AXView

1. Maintenance Staff can check the Alarm LED for basic troubleshooting.



2. Relay output

Below is a very simple application for remote notice use relay and lamp.

a) Normal

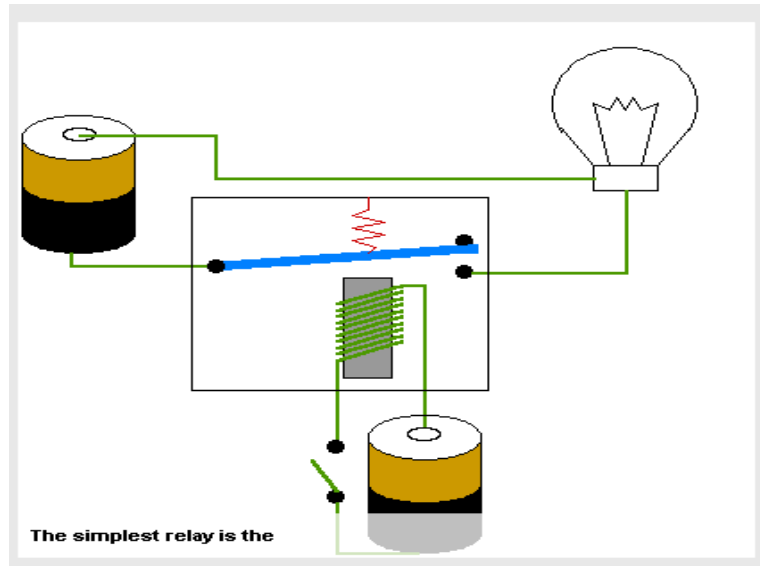

b) Warning

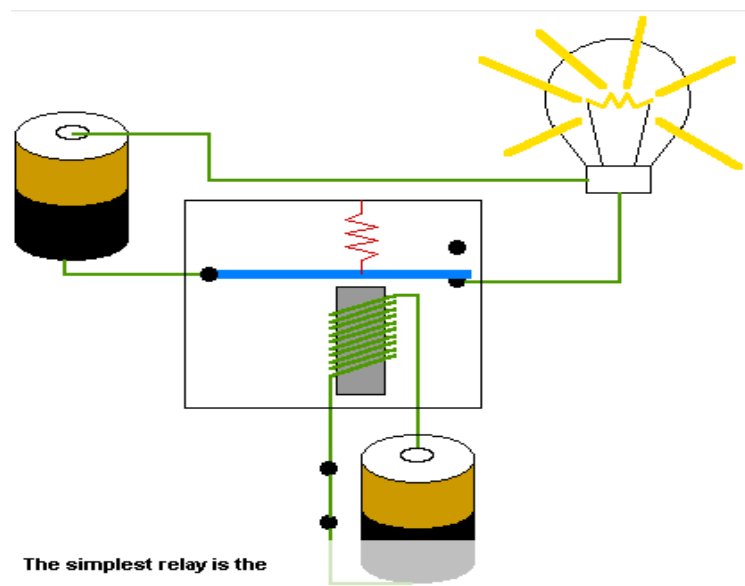

c) Relay wiring of rBOX

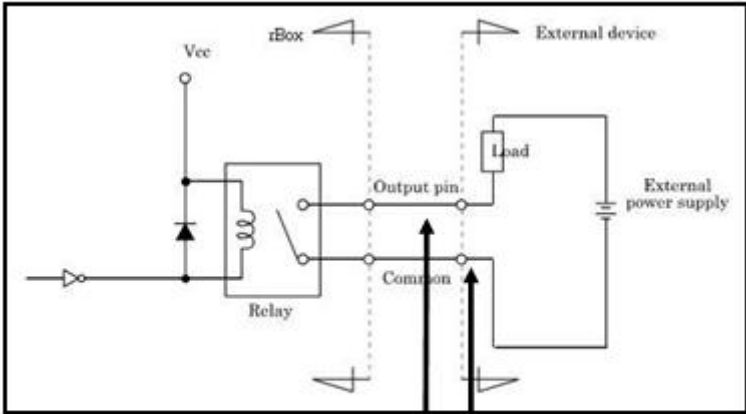

3. SNMP

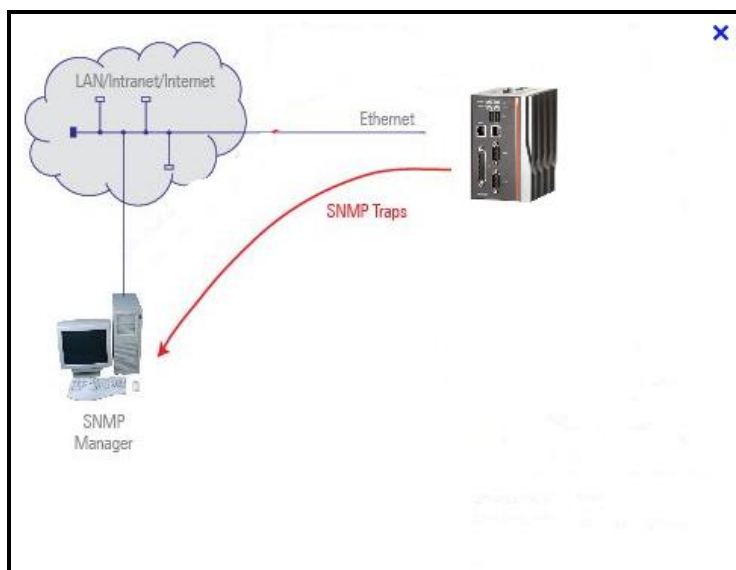

1.2.15 Mini Card

- 1 x Mini Card (3G/GPRS or Wifi)
- 1 x SIM Card Socket under CF slot for easy to access.

1.2.16 Reset Bottom

- 1 x Reset bottom

1.2.17 Operation Temperature

- -40°C ~ +70°C (-40 °F ~ +158°F), with W.T. (Memory & CF)

1.2.18 Storage Temperature

- -45°C ~ +85°C (-49 °F ~ +185°F)

1.2.19 Humidity

- 5% ~ 95% (non-condensation)

1.2.20 Weight

- 1.38 kg (3 lb)

1.2.21 Dimensions

- 100.6mm(3.18") (W) x110mm(4.33") (D) x135mm(5.31") (H)

1.2.22 System I/O Outlets

- Four 9-pin D-Sub male connectors, COM1~COM4.
- One 15-pin D-Sub female connector for VGA.
- Two 1000/100/10-Base-T Ethernets with magnetic isolation protection.
- Two USB 2.0 connectors.
- Two DC Power Inputs with terminal block.
- Alarm Contact.
- One Mini Card slot (3G/GPRS or Wifi).
- Two Audio jackers (Line in & Line out).



Note: *All specifications and images are subject to change without notice.*

1.3 Dimensions

The following diagrams show you dimensions and outlines of the rBOX310-FL

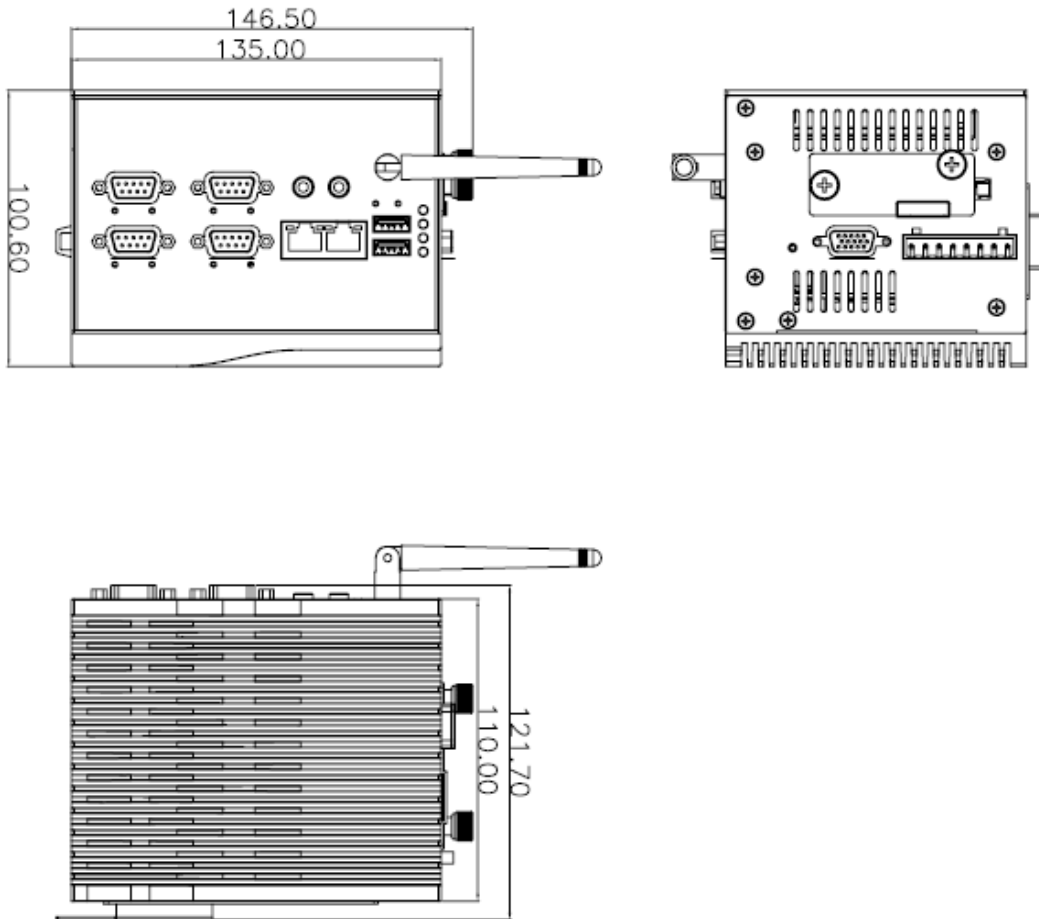

1.4 I/O Outlets

The following figures show you I/O outlets on front view and top view of the rBOX310-FL.

- **Front View**

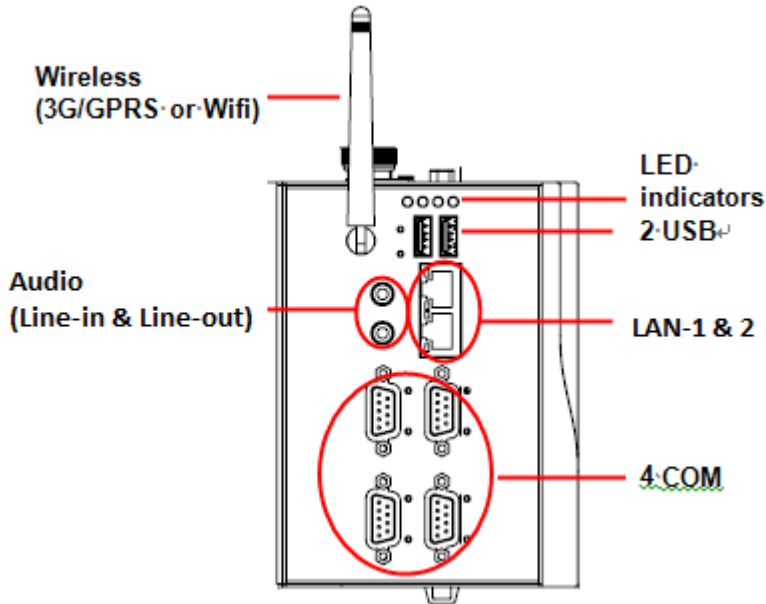

- **Top View**

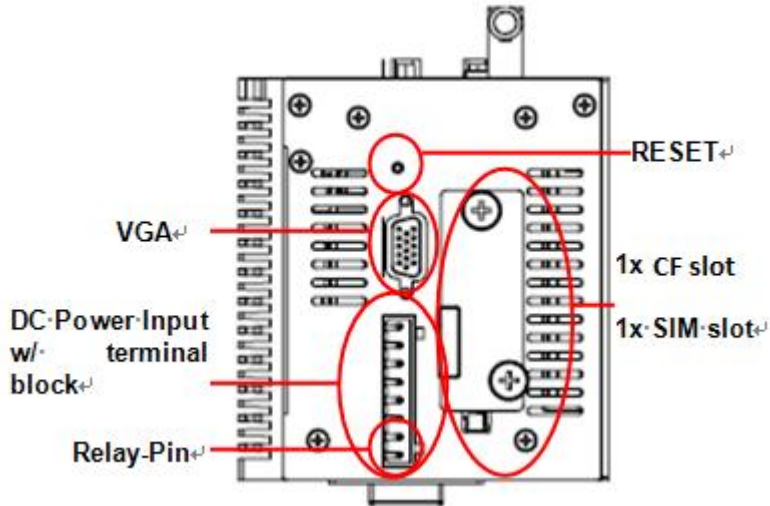

This page is intentionally left blank.

CHAPTER 2 HARDWARE INSTALLATION

The rBOX310-FL is convenient for your various hardware configurations, such as Memory Module and CompactFlash™ card. The chapter 2 will show you how to install the hardware. It includes:

2.1 Installing the Memory Module

Step 1 Turn off the system.

Step 2 Loosen these screws, and remove the top cover from the system.

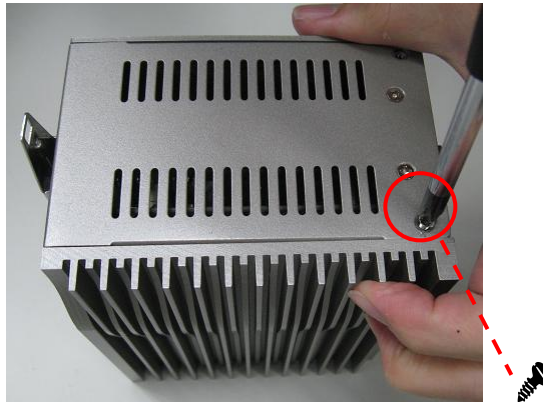

- Step 3** Take the thermal pad from the package, take off the masks of the thermal pad from two sides and paste thermal pad to the bottom side of the memory module as bellow figures.

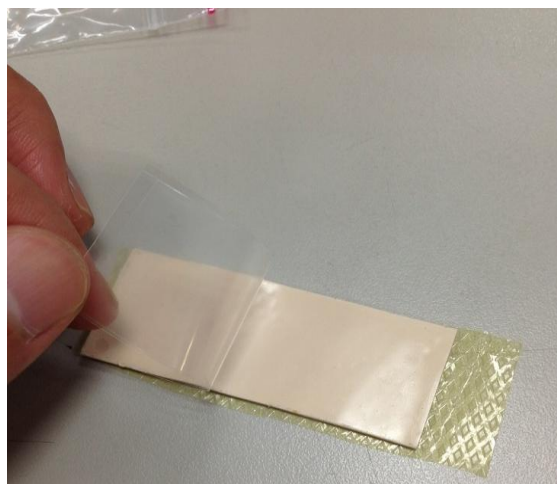

Step 4 Using two fingers to hold the memory module, and insert the gold colored contact into the socket. Push the module down.

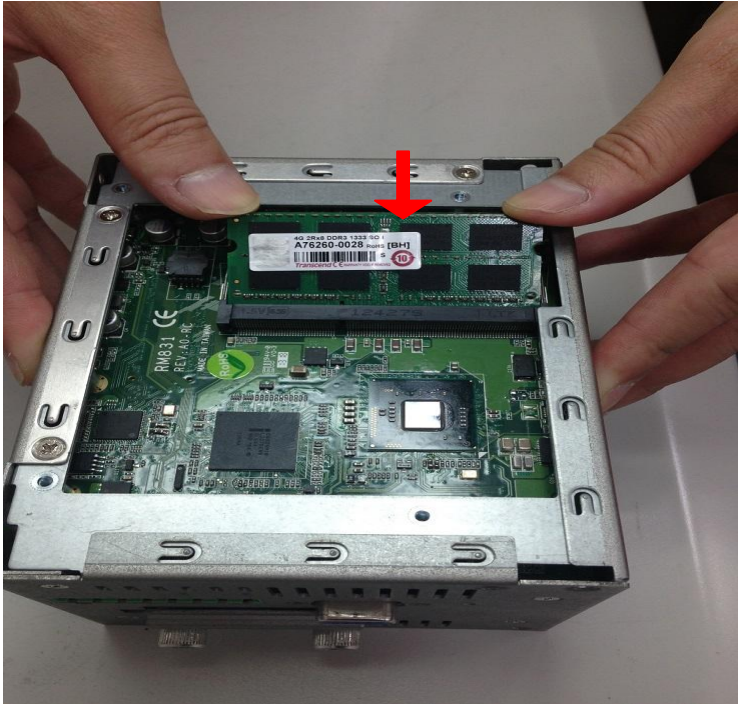

Step 5 The memory module is locked by two latches on the sides. We strongly recommend using “LDC737” silicone on the two sides of the memory for good ability of vibration.

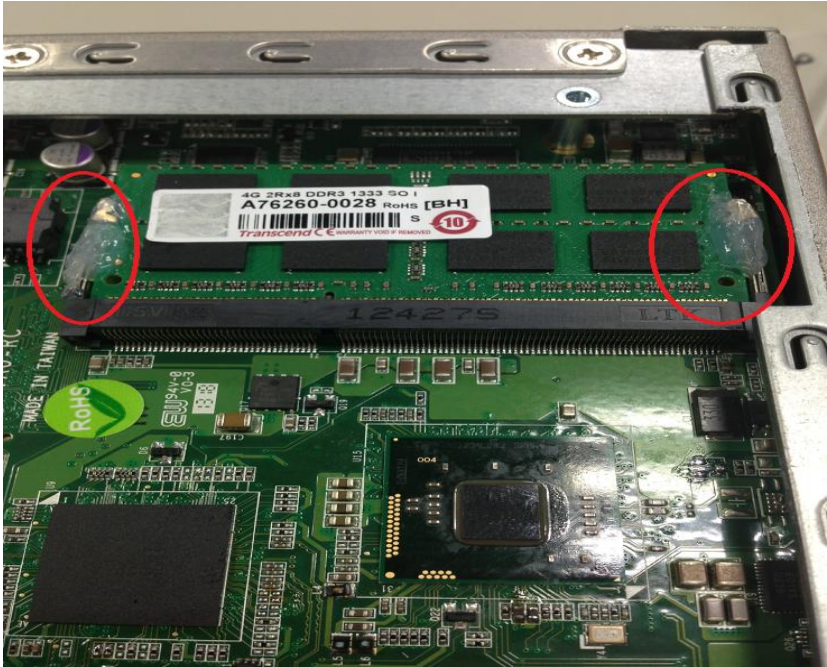

Step 6 Take off the memory thermal mask from the cover back.

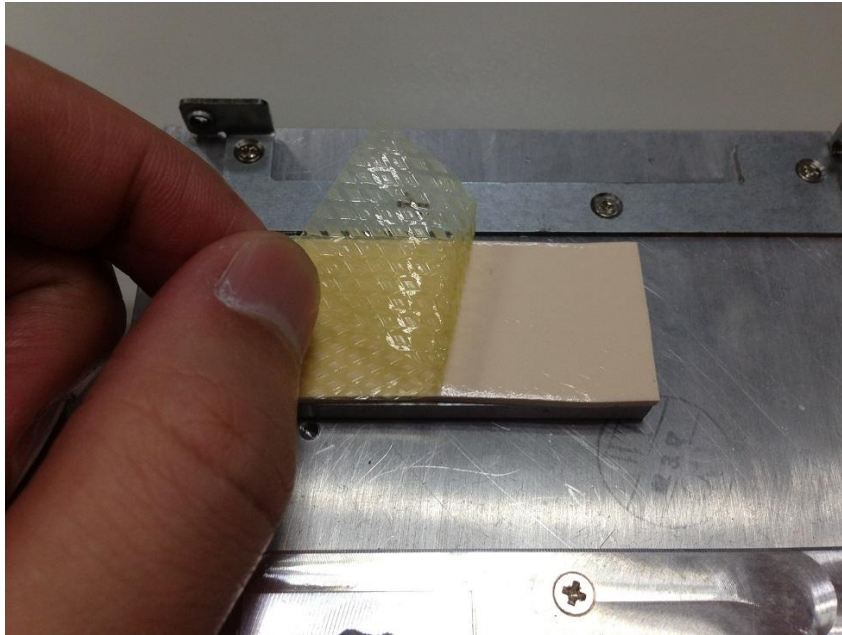

Step 7 Put the cover back to the system, and fasten screws tight close the chassis.

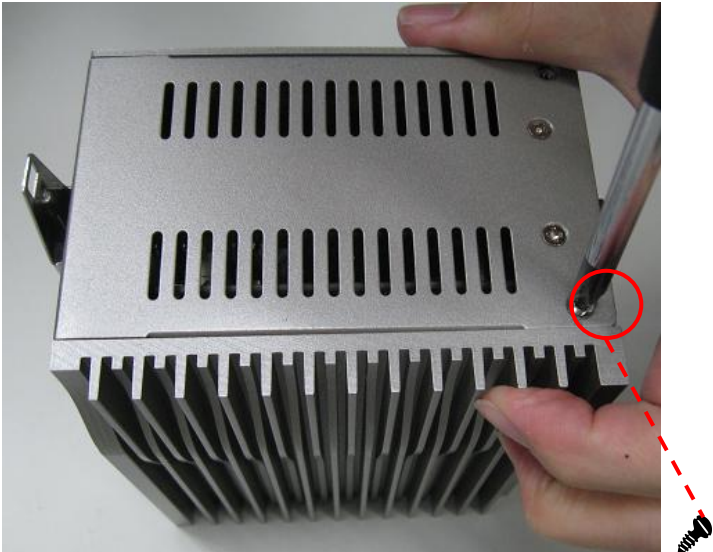

2.2 Installing the Hard Disk Drive

Step 1 Turn off the system.

Step 2 Loosen these screws, and remove the cover from the system.

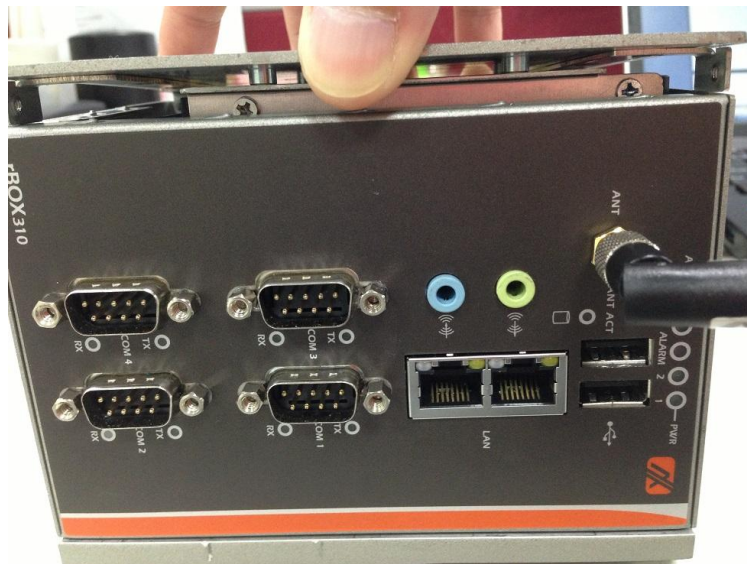

Step 3 Locate the Hard Disk Drive socket.

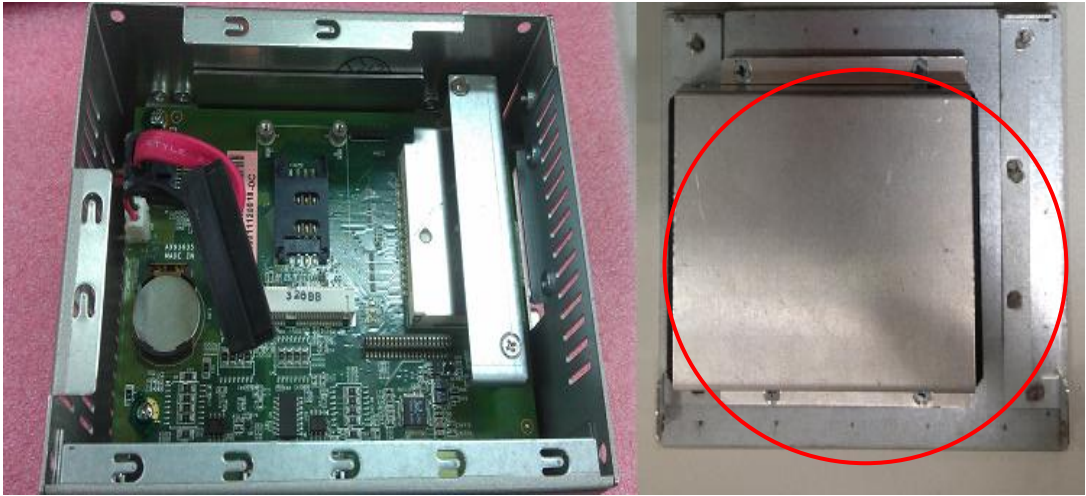

Step 4 Loosen these screws and remove the Hard Disk Drive bracket.



Step 5 Insert the HDD into the socket until it is firmly seated.

Step 6 Put the CompactFlash™ fixing bracket back to the system, and fasten screws tight close the CompactFlash™ fixing bracket.

Step 7 Put the cover back to the system, and fasten screws tight close the chassis.



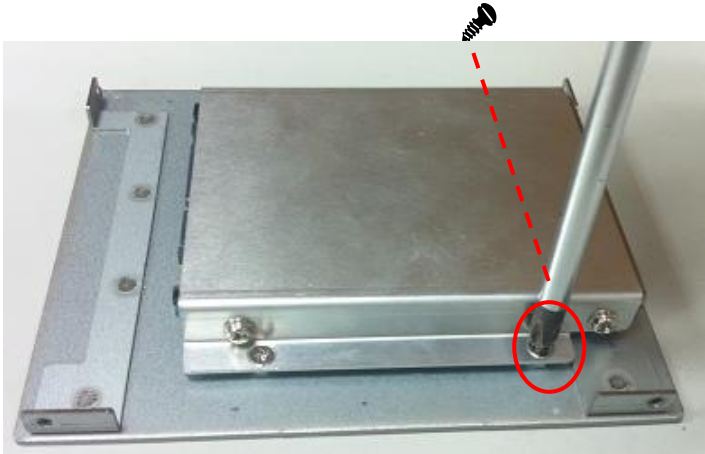

2.3 Installing Din-rail Mounting

The rBOX provides Din-rail Mount that customers can install as below:

Step 1 Prepare Din-rail Mount assembling components (screws and bracket) ready.



Step 2 Assembly the bracket to the system, and fasten screws tight.





Note: Please notice the Din-rail holes with Wall-mounting holes while assembly the bracket to system.

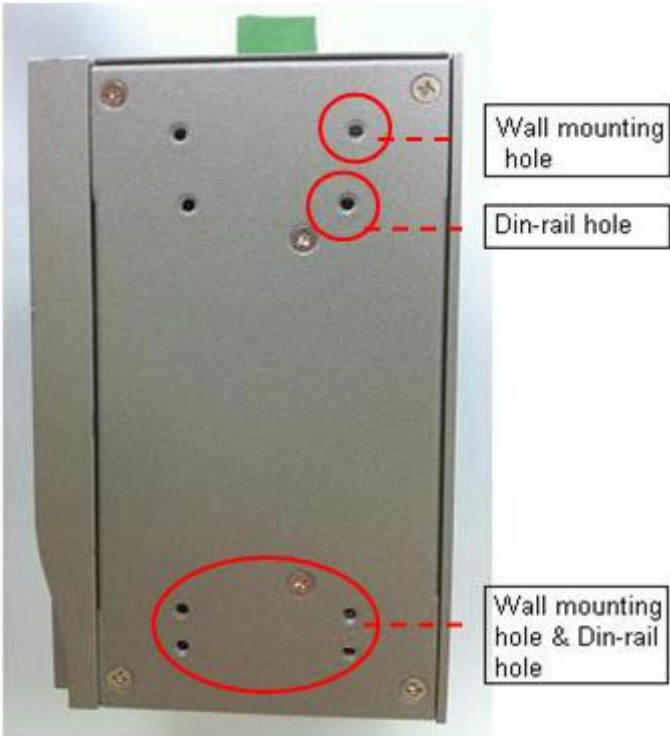



Note: The Din-rail hole drawing for rBOX310 is listed below:

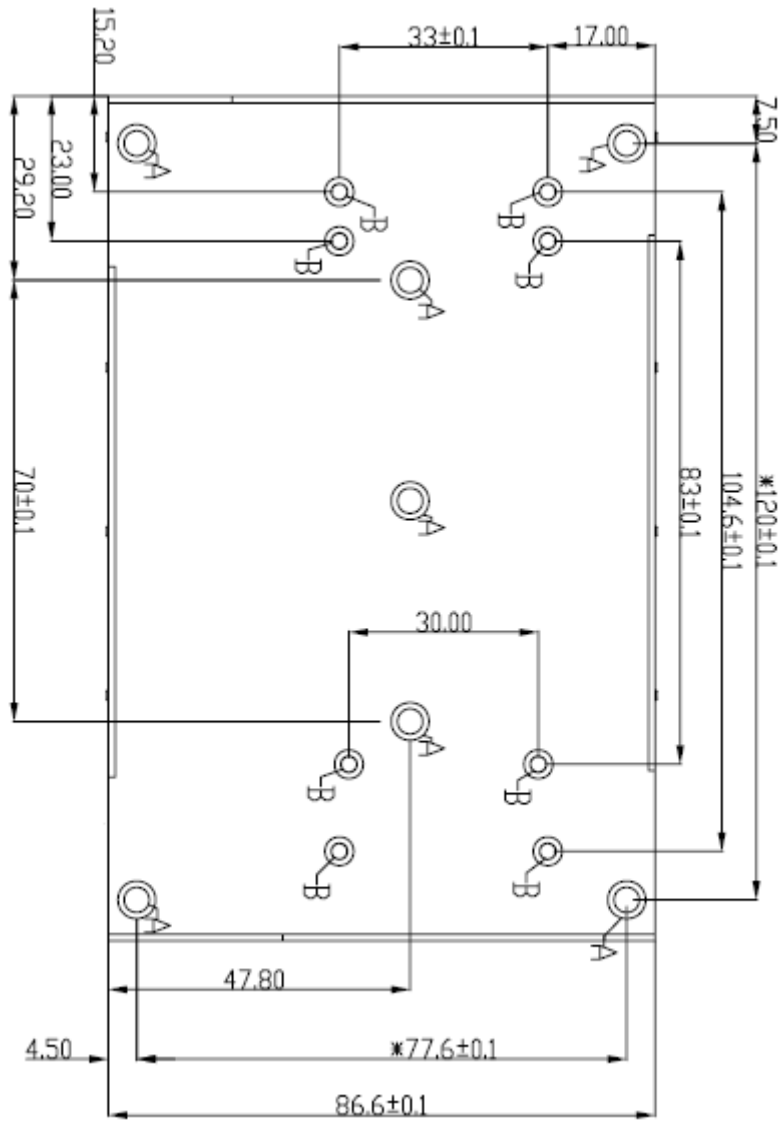



Note: The Din-rail kit drawing is listed below:

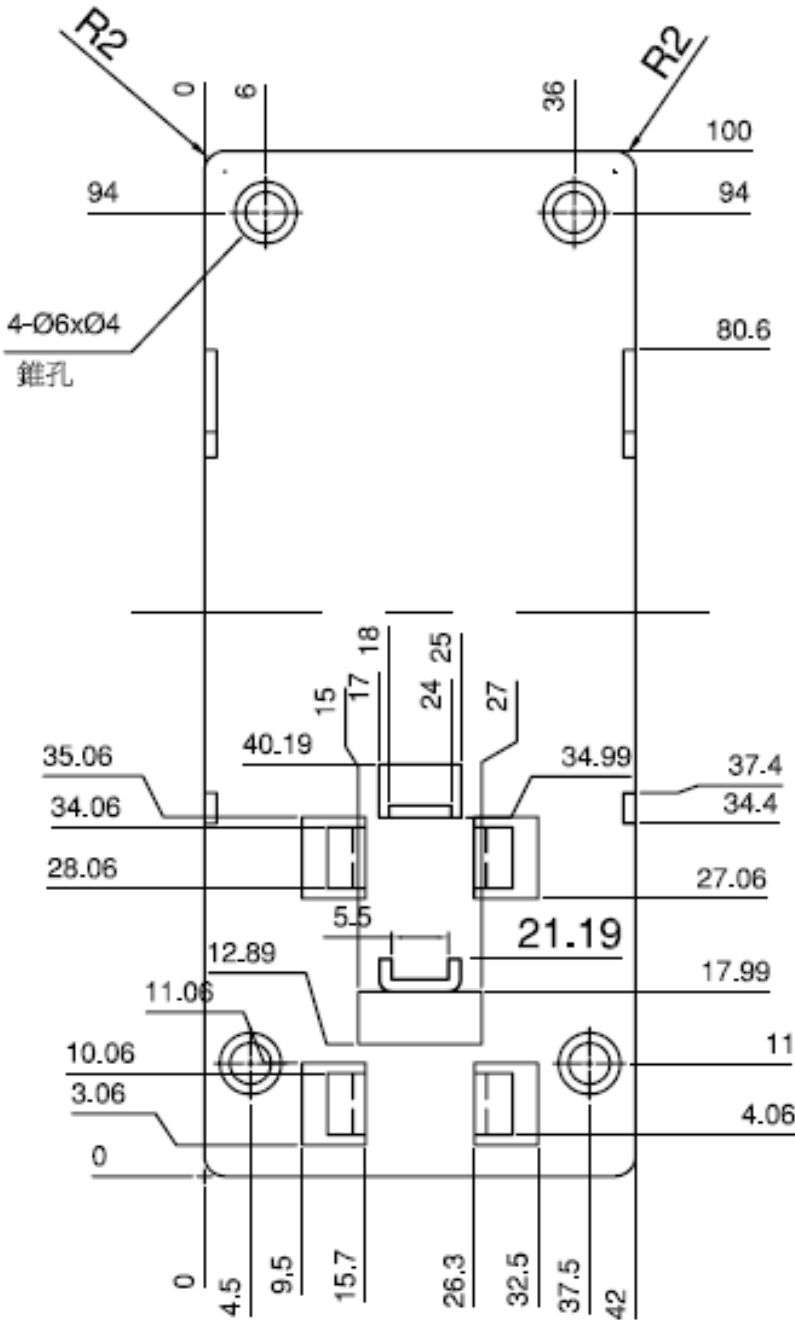

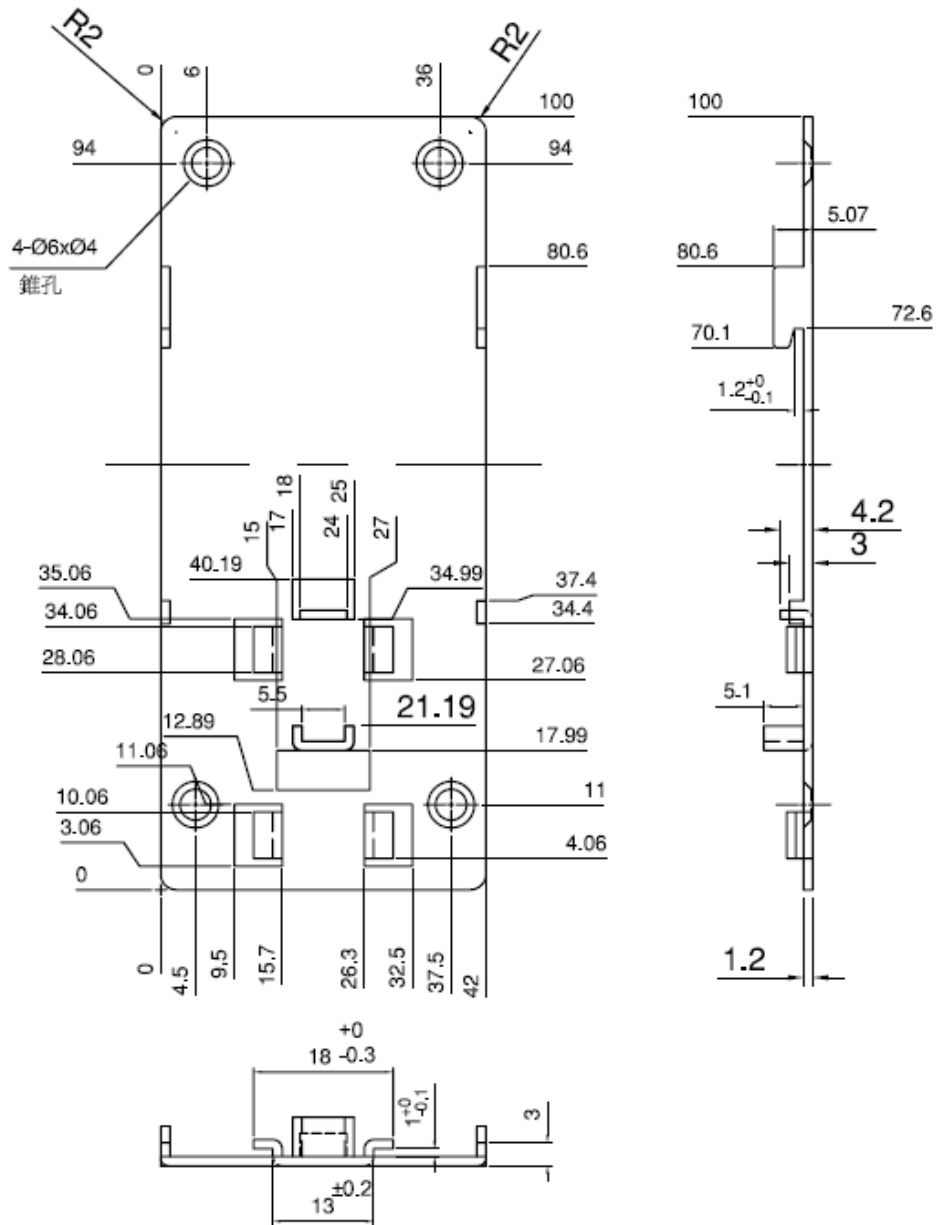

- **Setting up rBOX by Din-rail mounting**

The rBOX set up by Din-rail mounting as below:

Step 1 Fixing the rail firstly.



Step 2 Set up the rBOX on the rail by Din-rail mounting





2.4 Installing Wall Mounting (optional)

The rBOX provides Wall Mounting that customers can install as below:

Step 1 Prepare Wall Mount assembling components (screws and bracket) ready.



Step 2 Assembly the bracket to the system, and fasten screws tight.

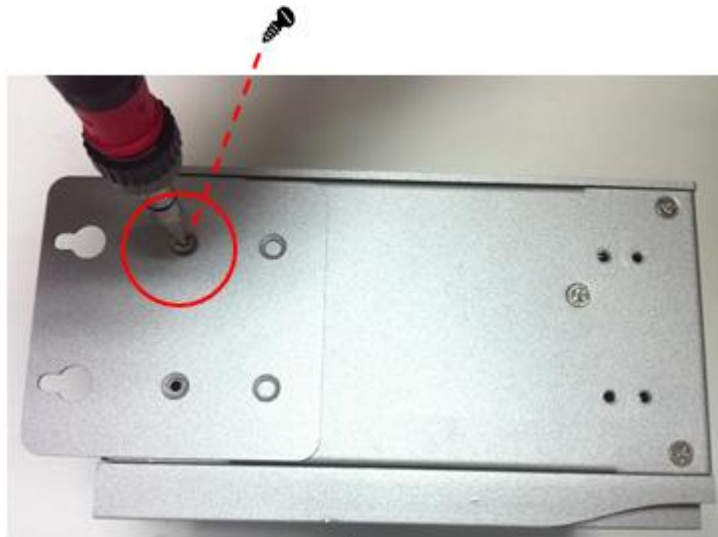

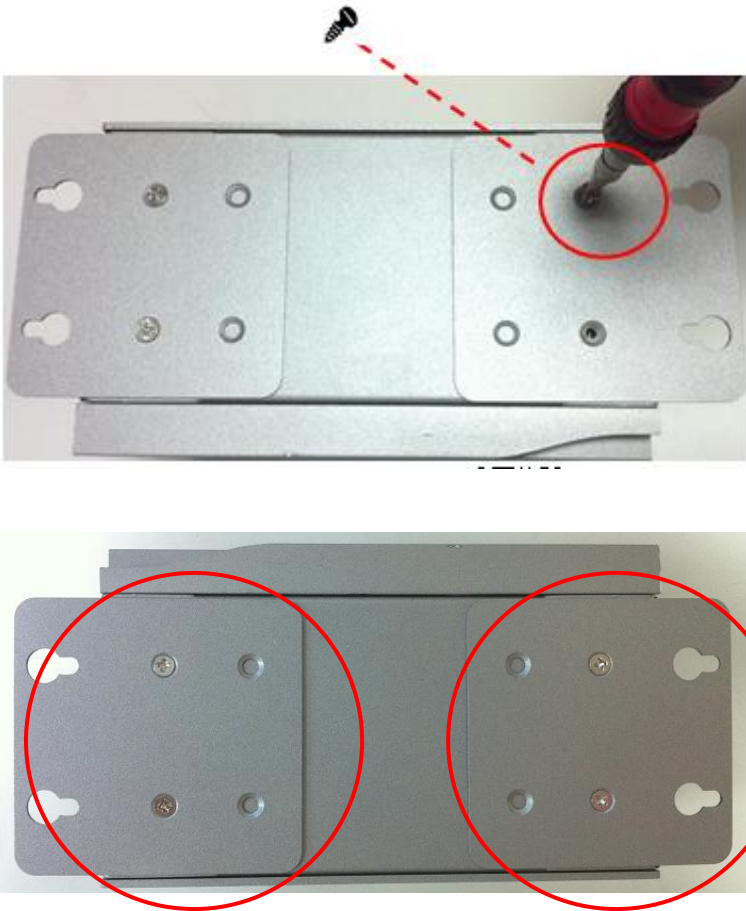

 **NOTE** Please notice the Din-rail holes with Wall-mounting holes while assembly the bracket to system.

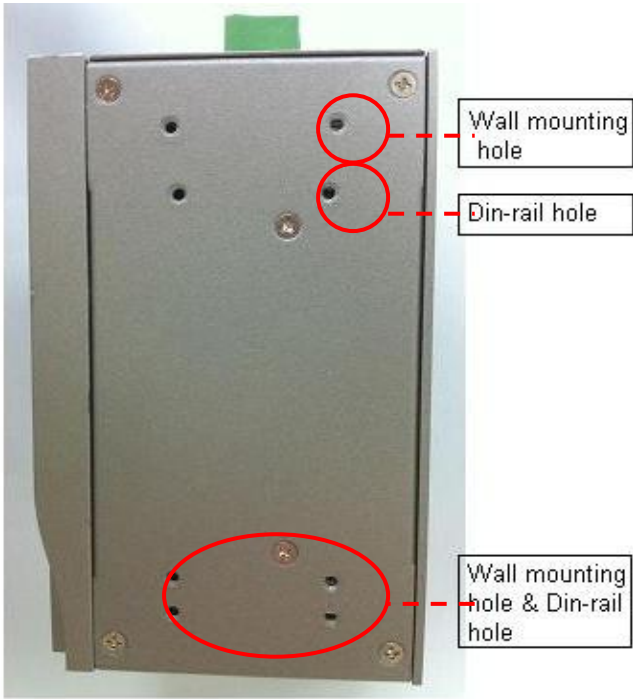

This page is intentionally left blank.

CHAPTER 3

AMI UEFI BIOS UTILITY

The AMI UEFI BIOS provides users with a built-in Setup program to modify basic system configuration. All configured parameters are stored in a flash-backed-up to save the Setup information whenever the power is turned off.

3.1 Entering Setup

To enter the setup screens, follow the steps below:

1. Turn on the computer and press the key immediately.
2. After you press the key, the main BIOS setup menu displays. You can access the other setup screens from the main BIOS setup menu, such as the Advanced and Chipset menus.

3.2 The Main Menu

Once you enter the AMI BIOS Aptio Setup Utility, the Main Menu appears on the screen. In the Main Menu, there are several Setup functions and a couple of Exit options for your selection. Use Select Screen Keys (or Move Keys) to select the Setup Page you intend to configure then press <Enter> to accept or enter its sub-menu.

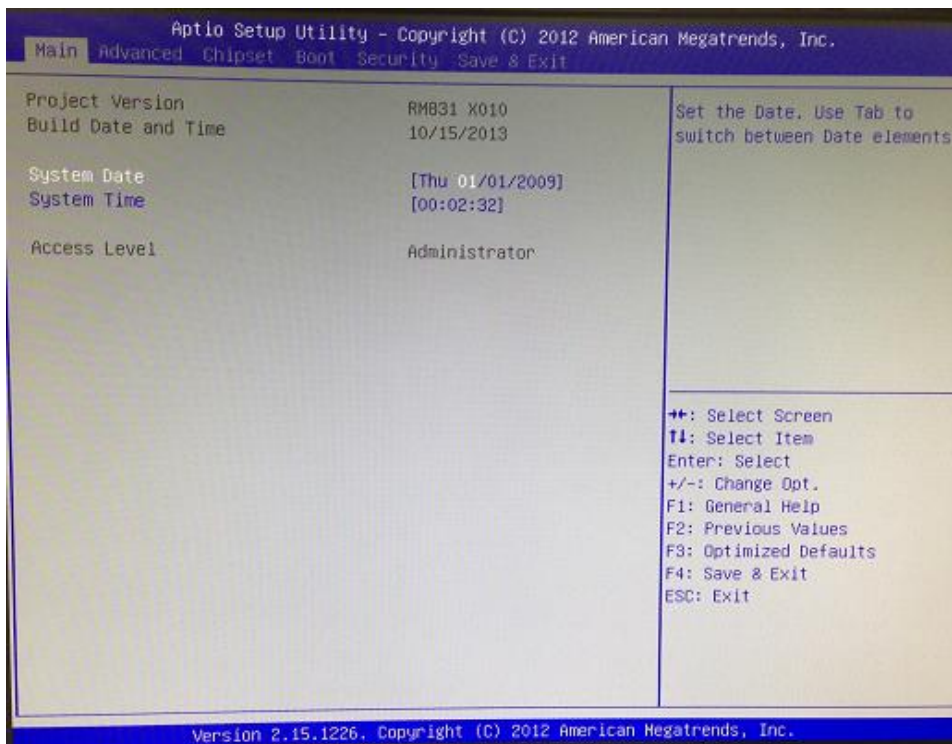

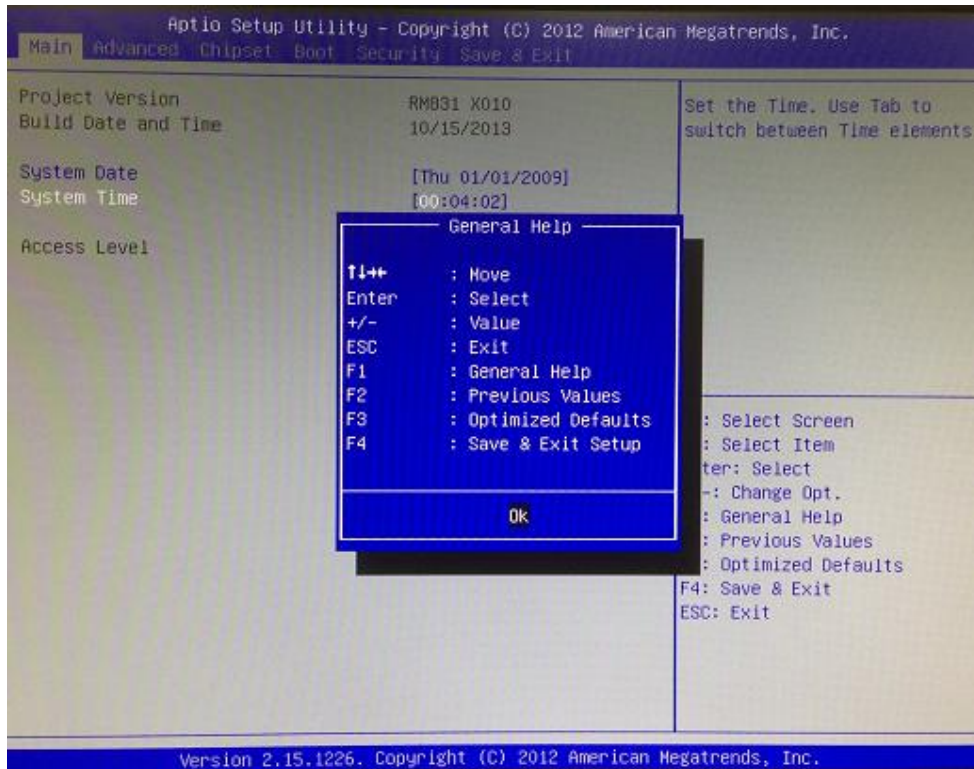

System Date

The date format is <day> <month> <date> <year>.

System Time

This item shows current time of your system with the format <hour> <minute> <second>. The time is calculated based on the 24-hour military-time clock. For example, 1 p.m. is 13:00:00.



Note: If system is power failure, the date and time will come back to previous setup.



Note: If your computer can not boot after making and saving system changes with Setup, the AMI BIOS will reset your system to the default settings via its built-in override feature.



Note: It is strongly recommended that you should avoid changing the chipset's defaults. Both AMI and your system manufacturer have carefully set up these defaults that provide the best performance and reliability.

3.3 Advanced Features

This Advanced section allows users to configure and improve your system, to set up some system features according to your preference. You can select any of the items in the left frame of the screen to go to the sub menus:

- **S5 RTC Wake Settings**

The default setting is “disable”.

If the default setting is changed for “enable”, you can set up the automatic boot time.

(Please refer below graphics.)

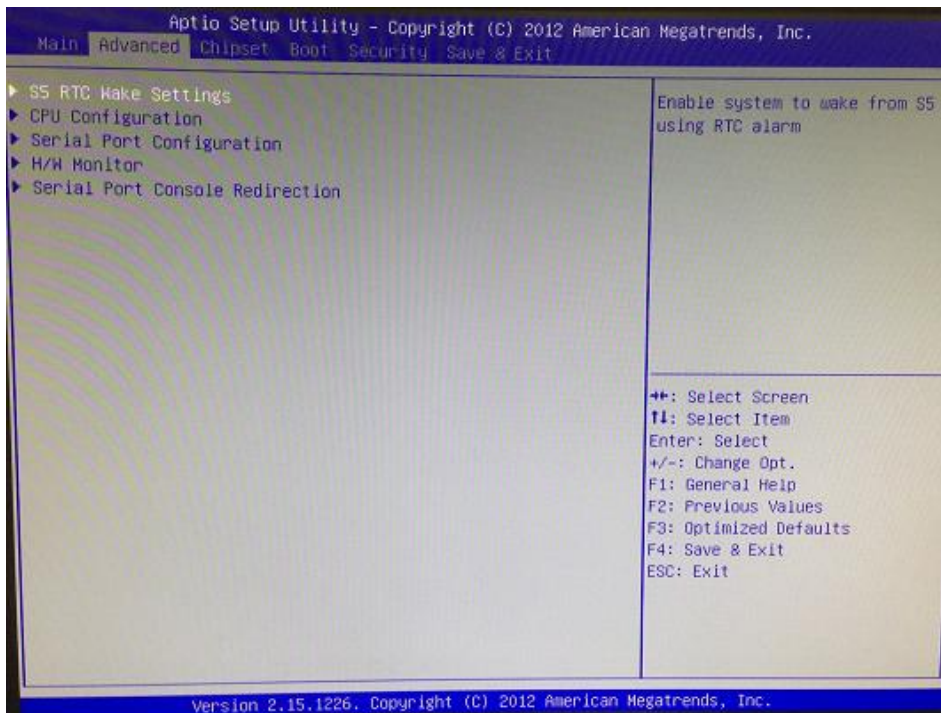

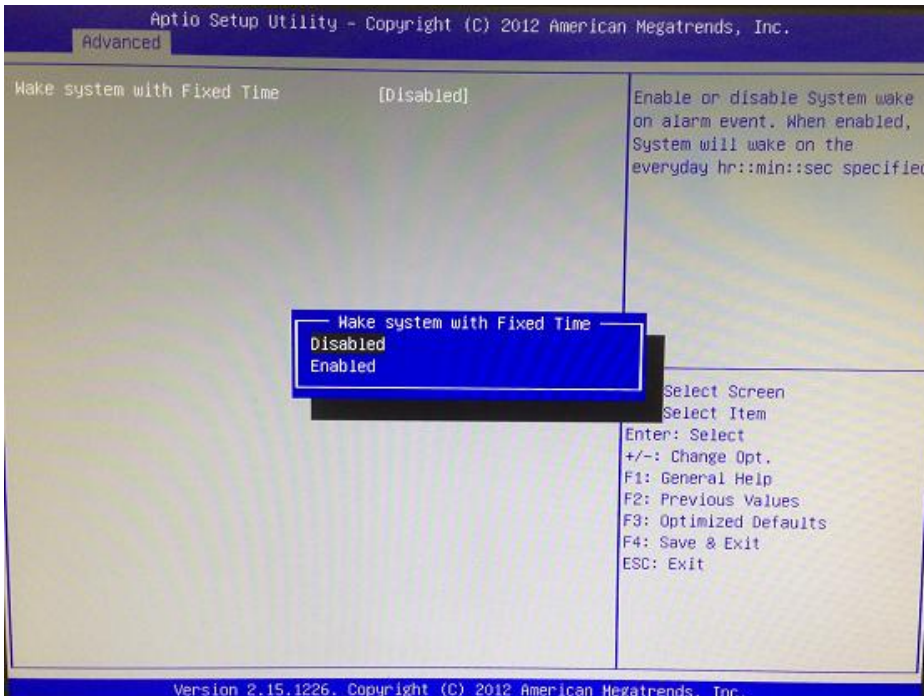
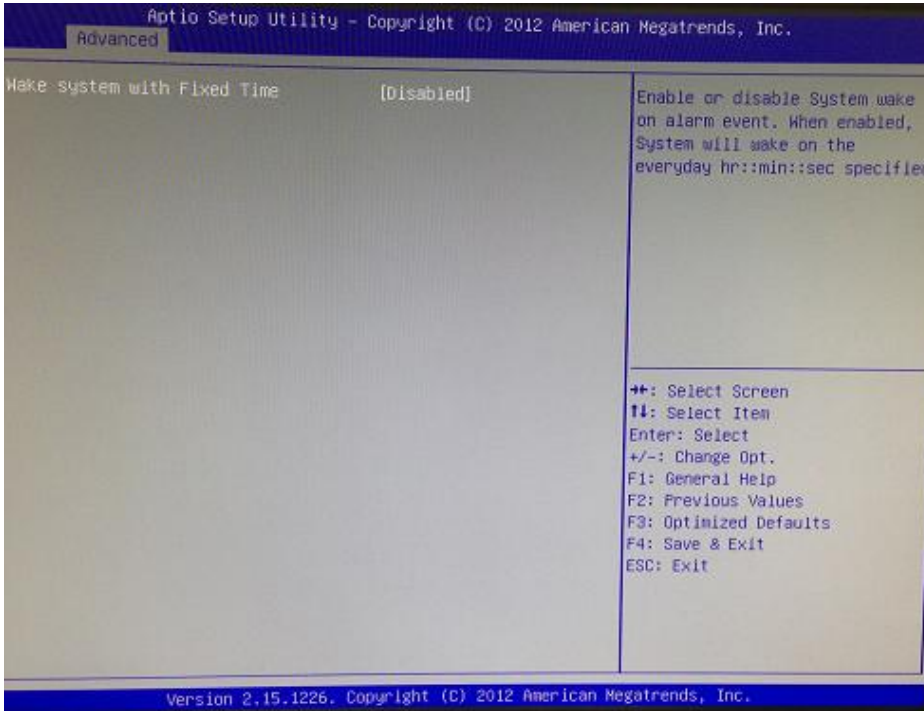

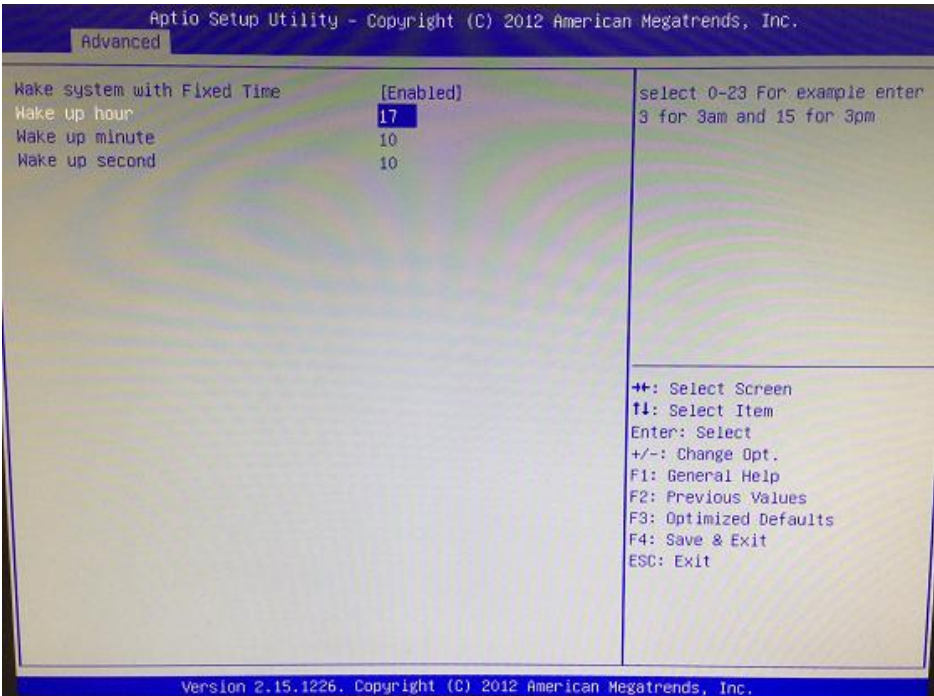

● **CPU Configuration**

Scroll to this item and press <Enter> to view the CPU Configuration informations.

(Please refer below graphics.)

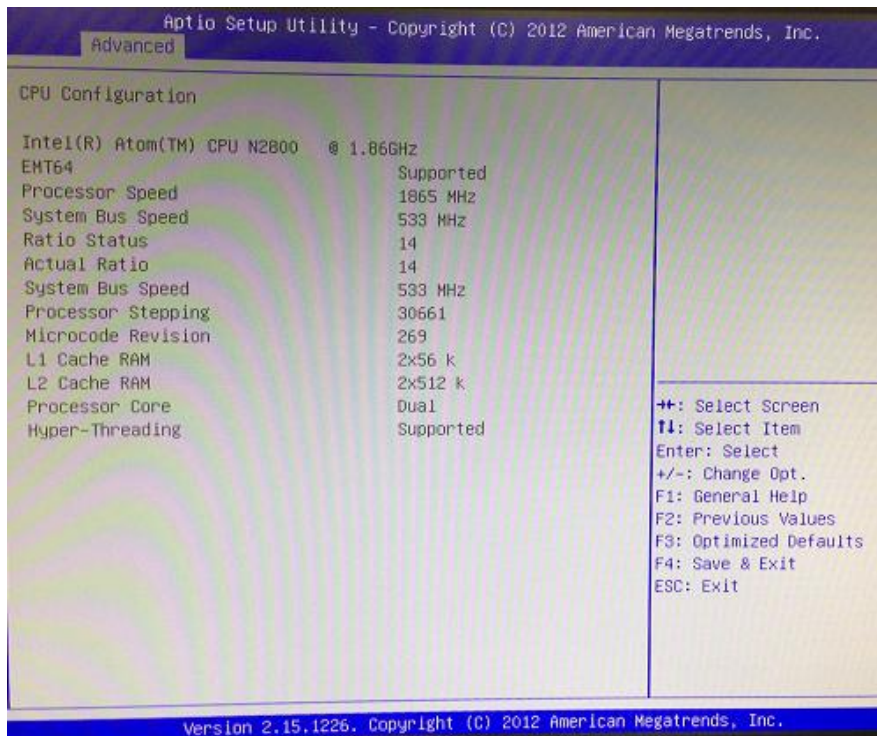
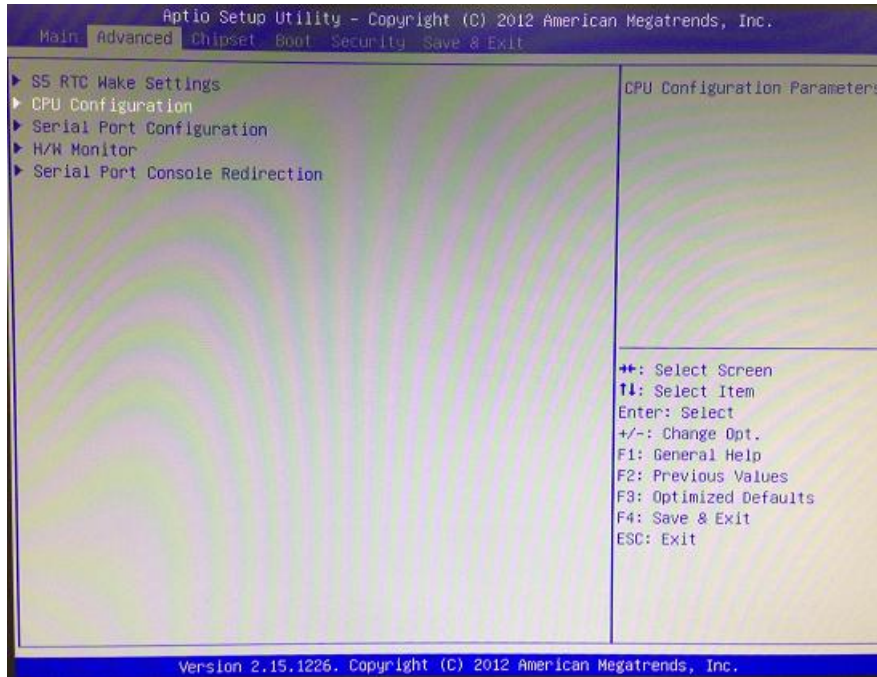

● **Serial Port Configuration**

The default setting for all COM Ports are RS232.
You can change the default setting by selecting the value you want in each COM Port Type.

(Please refer below graphics.)

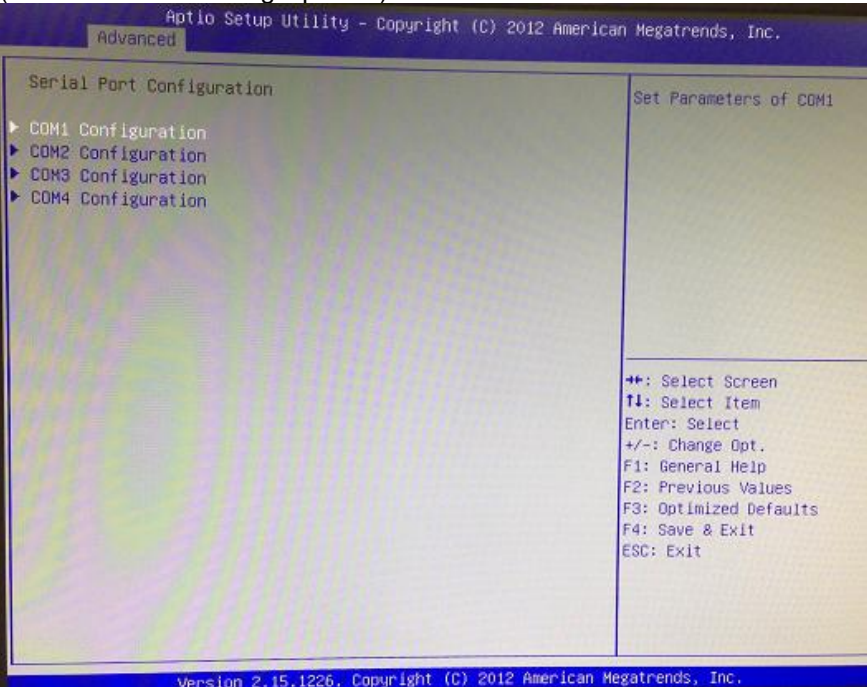

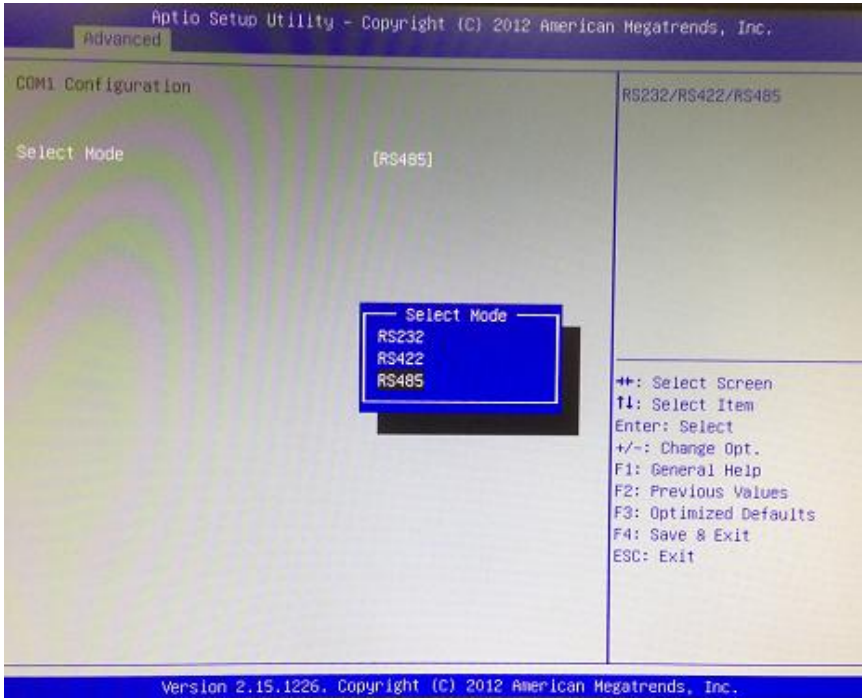

- **H/W Monitor**

Scroll to this item and press <Enter> to view the monitor hardware status.

(Please refer below graphics.)

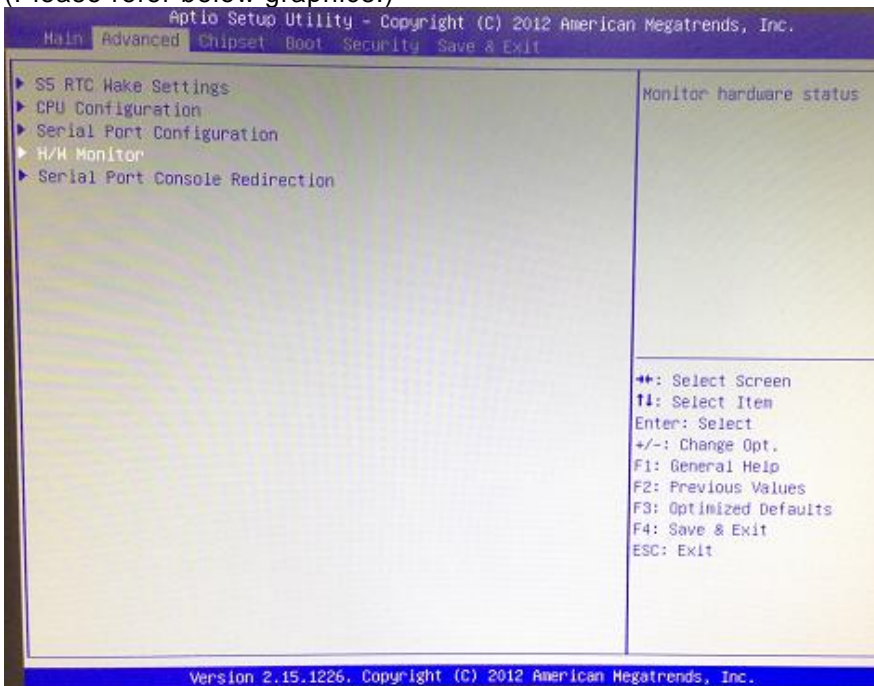

- **Serial Port Console Redirection**

Only COM1 has the console redirection function.

(Please refer below graphics.)

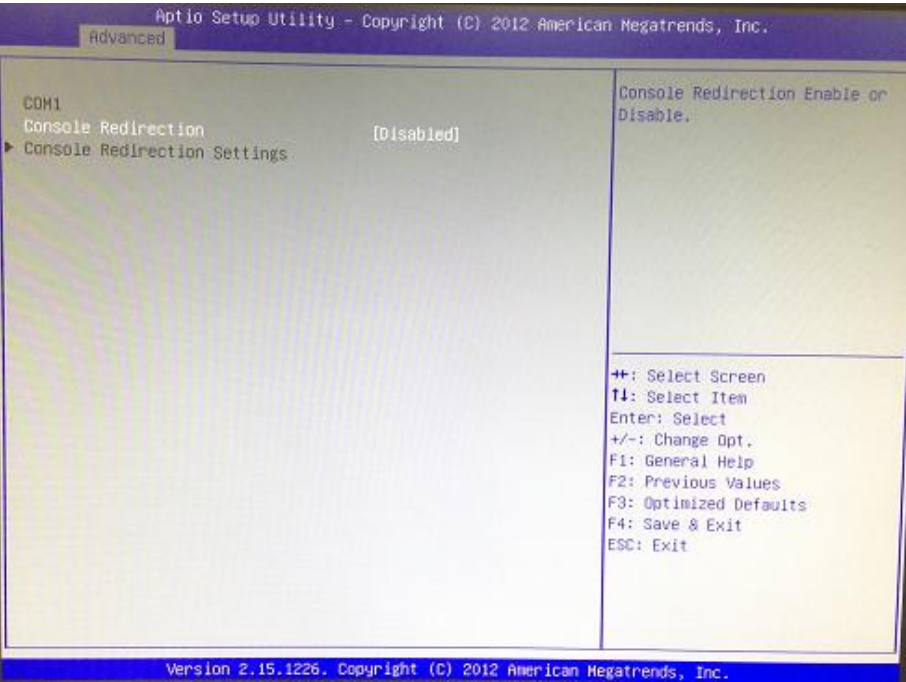
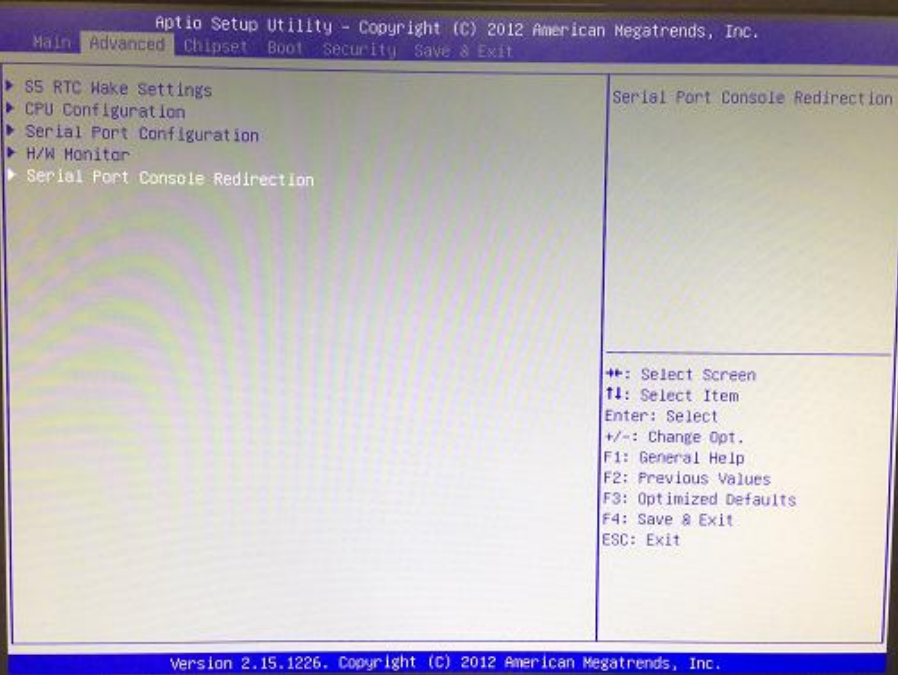

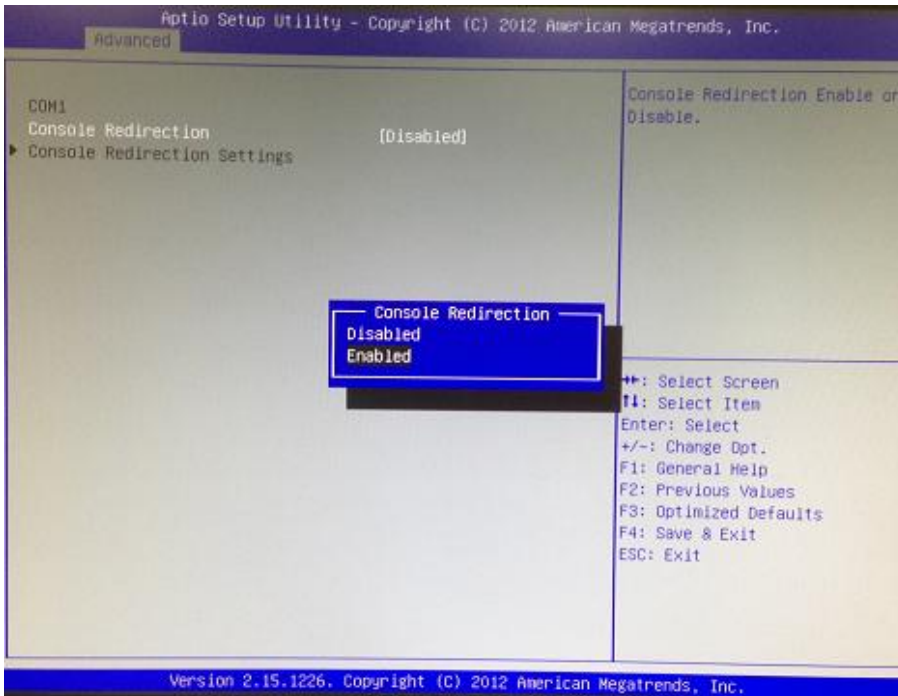

If the default setting for the console redirection function is changed for [Enabled], the settings specify how the host computer and the remote computer (which the user is using) will exchange data. Both computers should have the same or compatible settings.

And you can further change the setting by selecting or setting the value you want in each function as the following pictures.

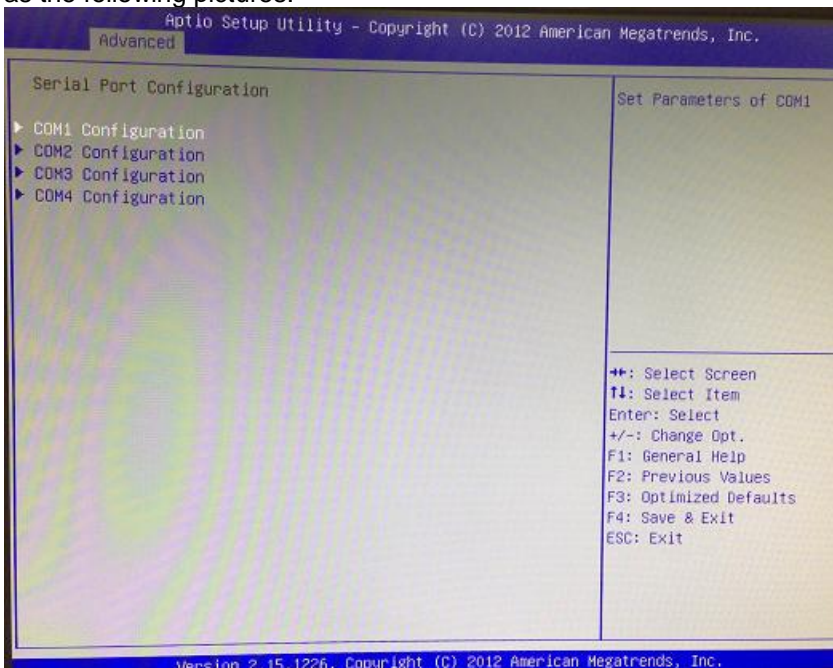

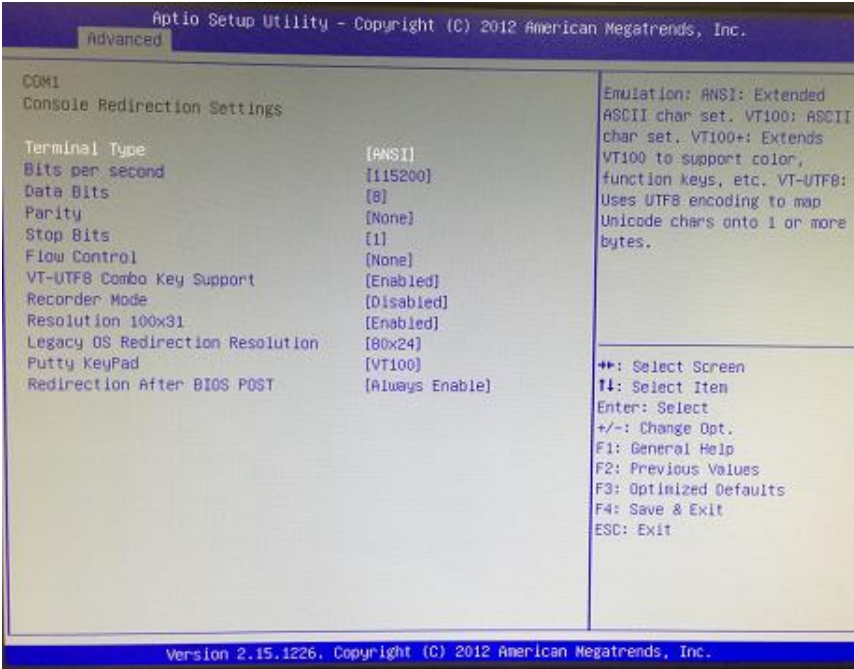
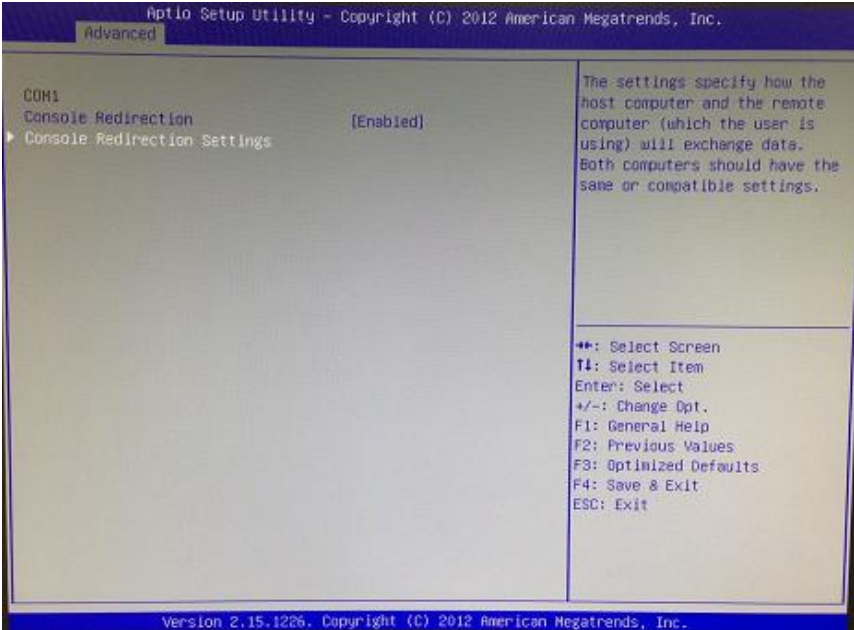

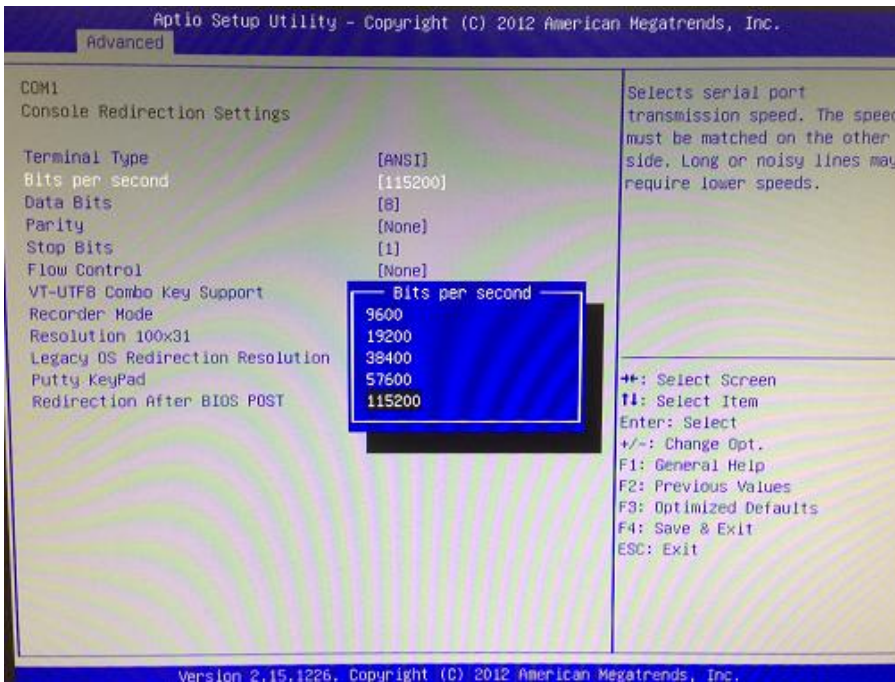
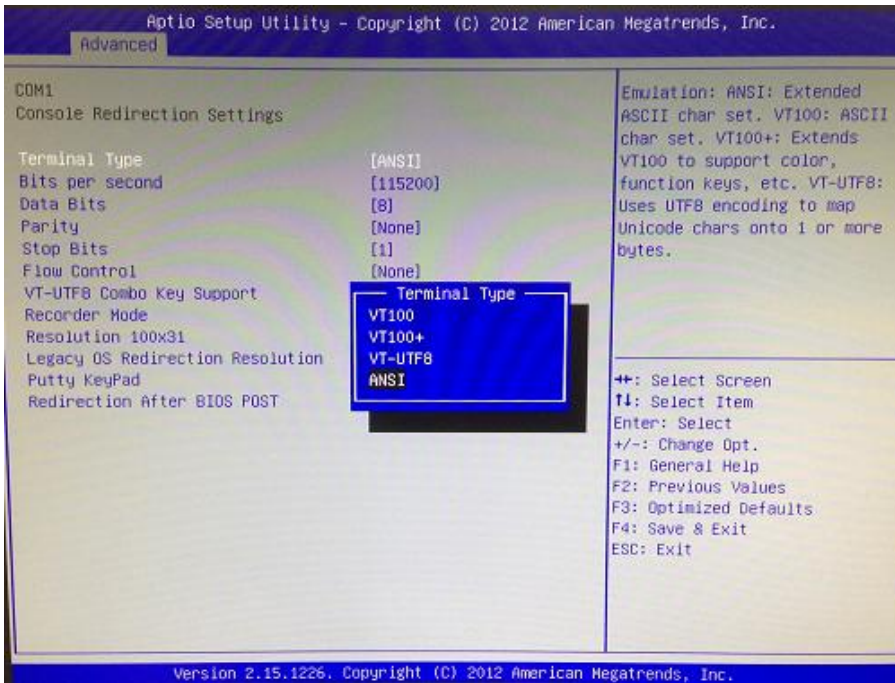

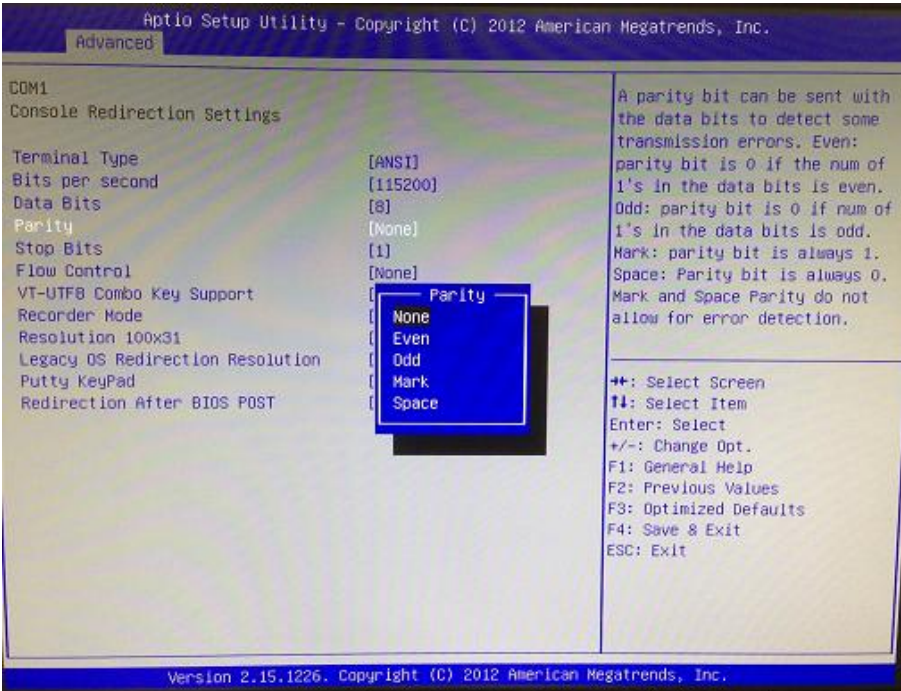
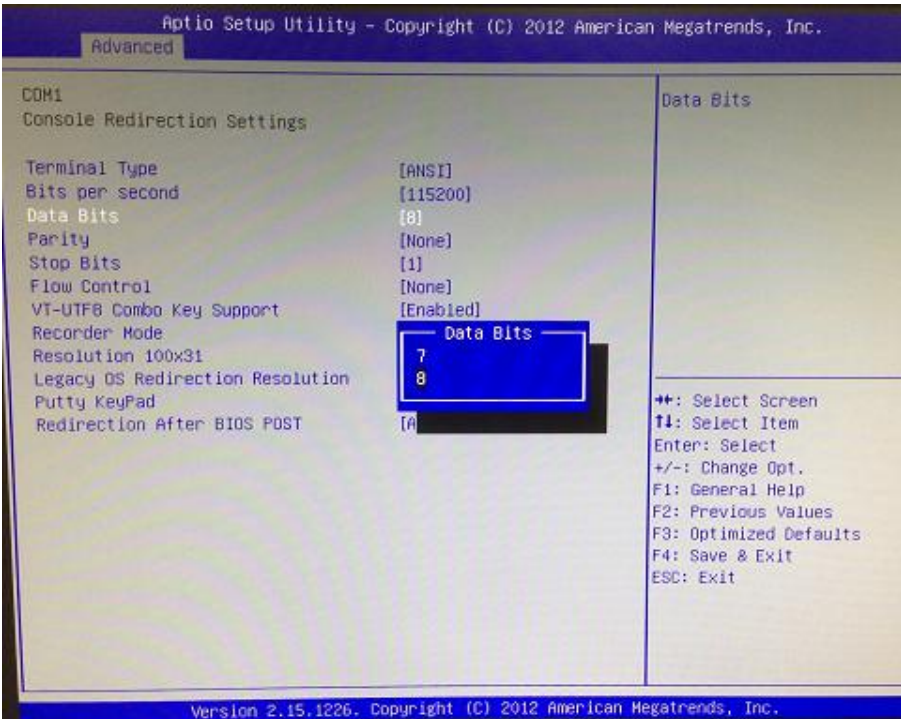

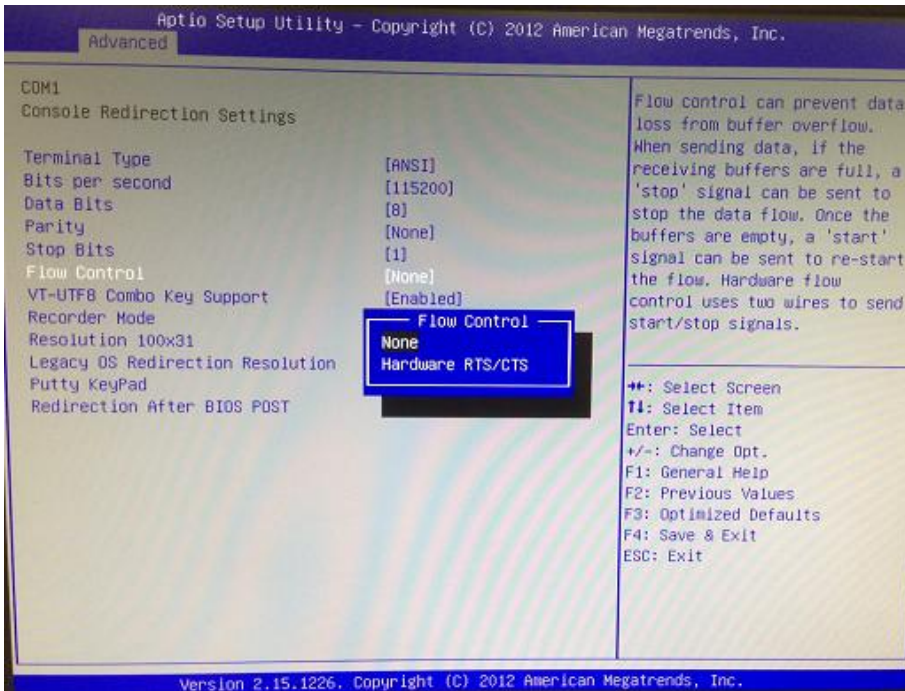
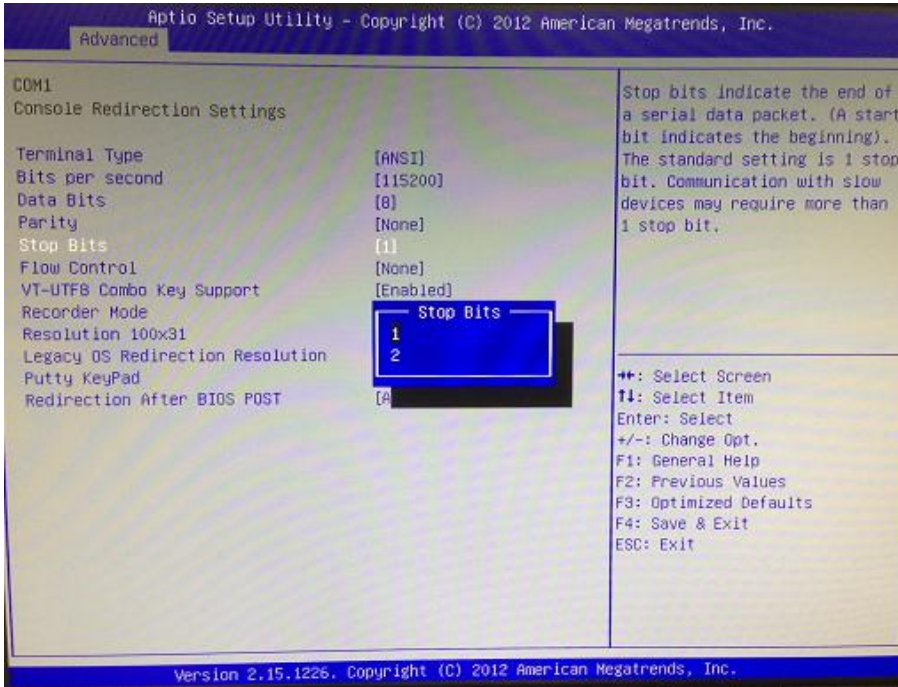

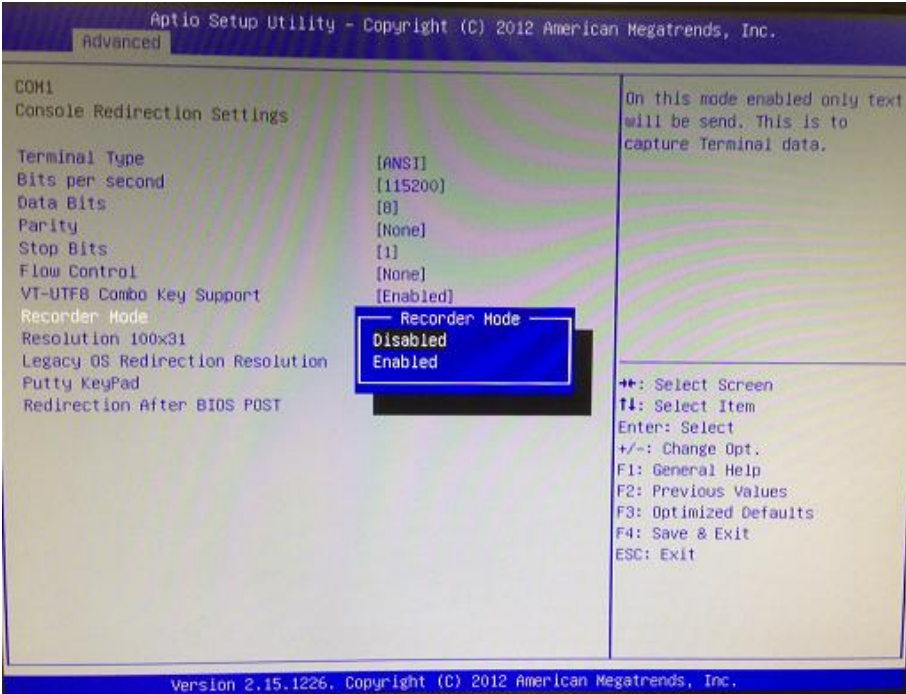
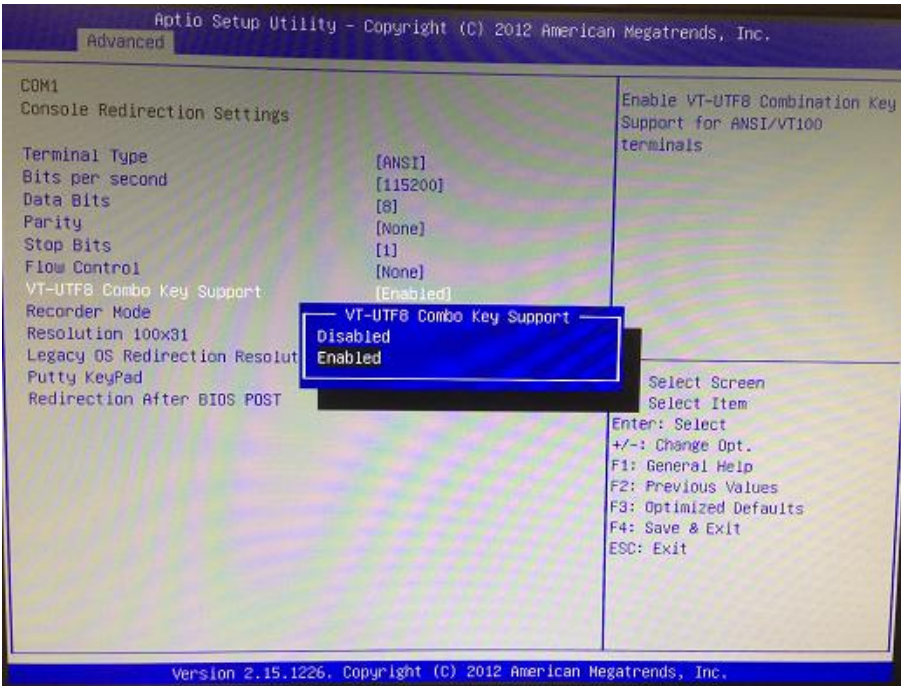

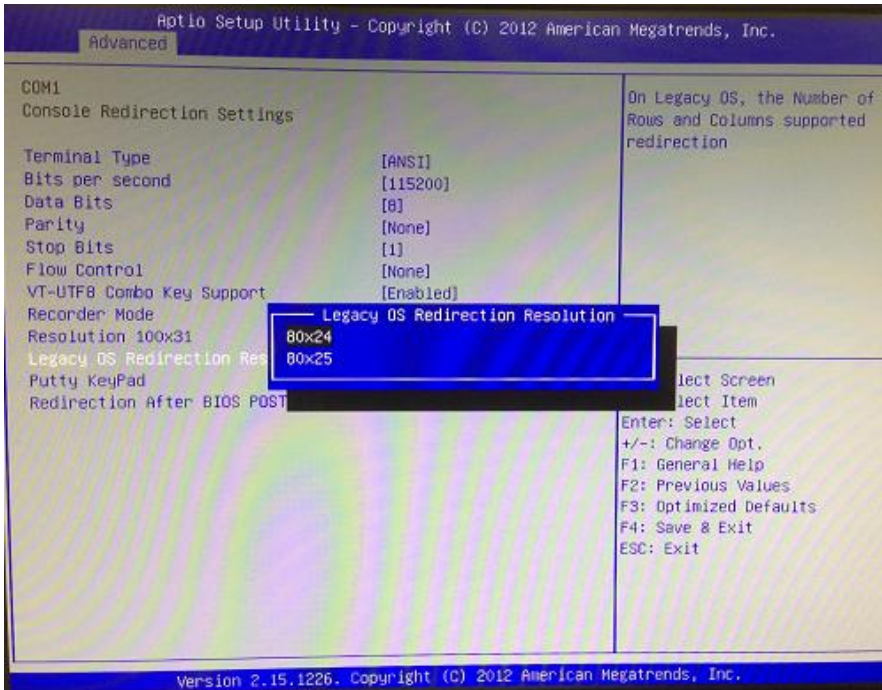
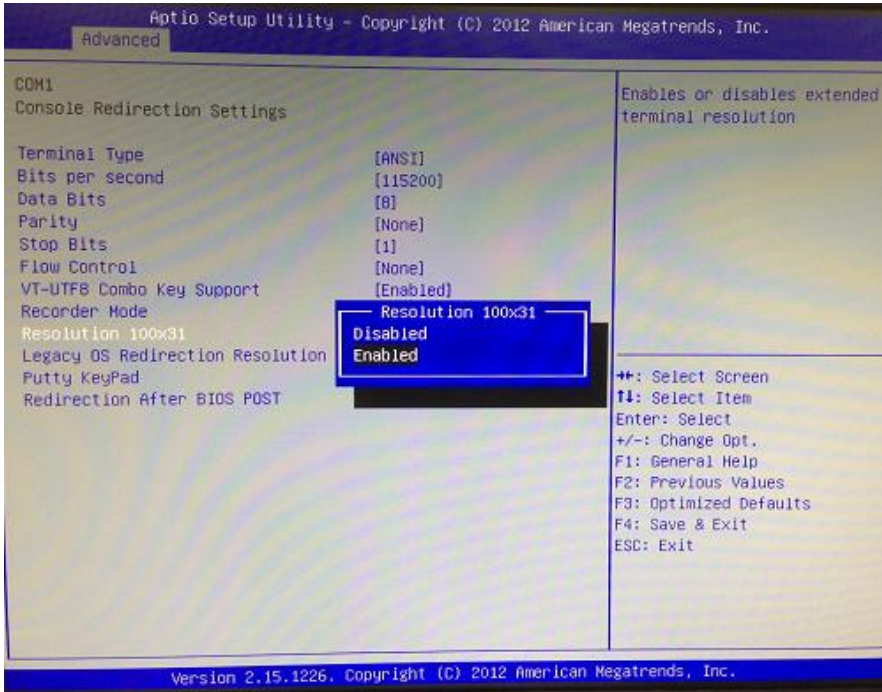

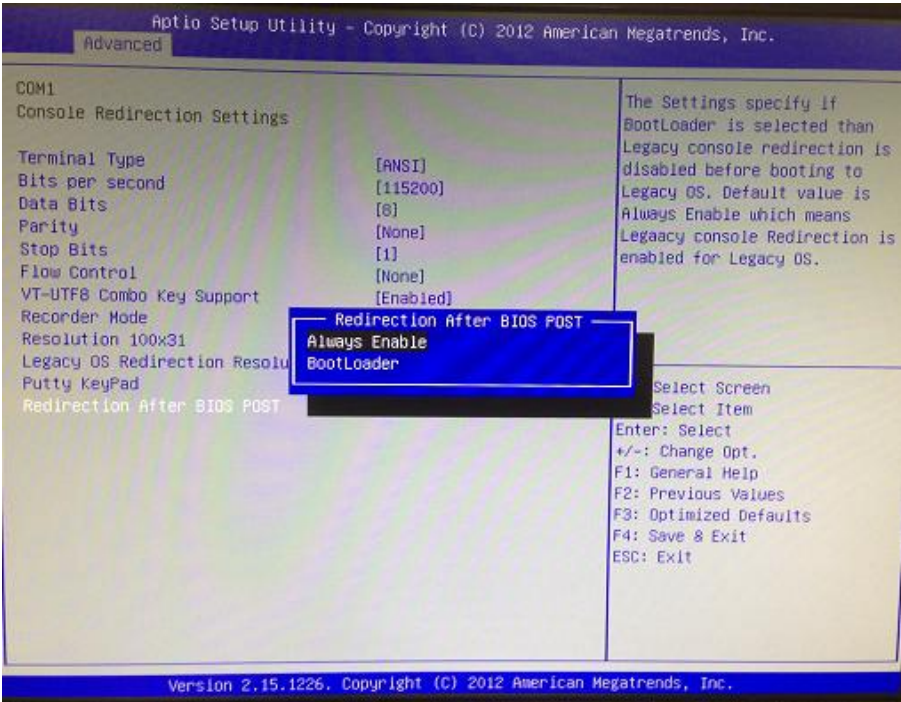
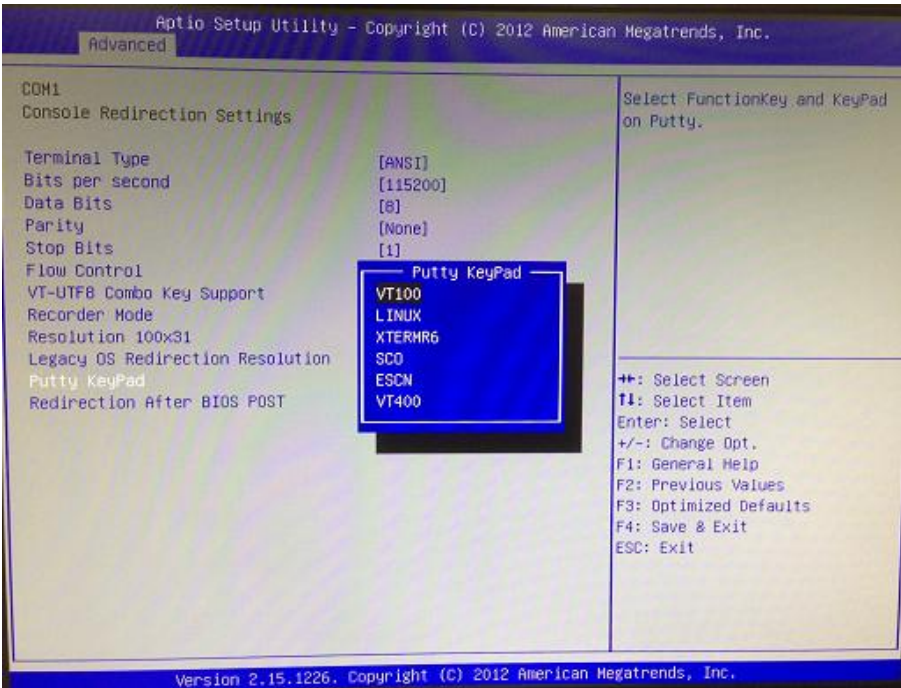

3.4 Chipset Feature

This section contains completely optimized chipset's features in the system

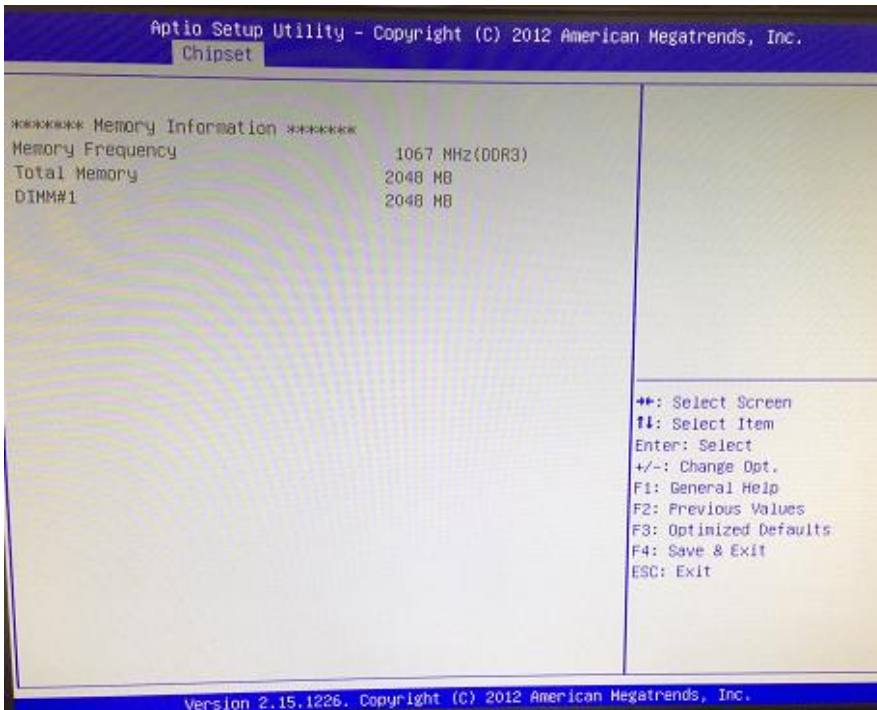
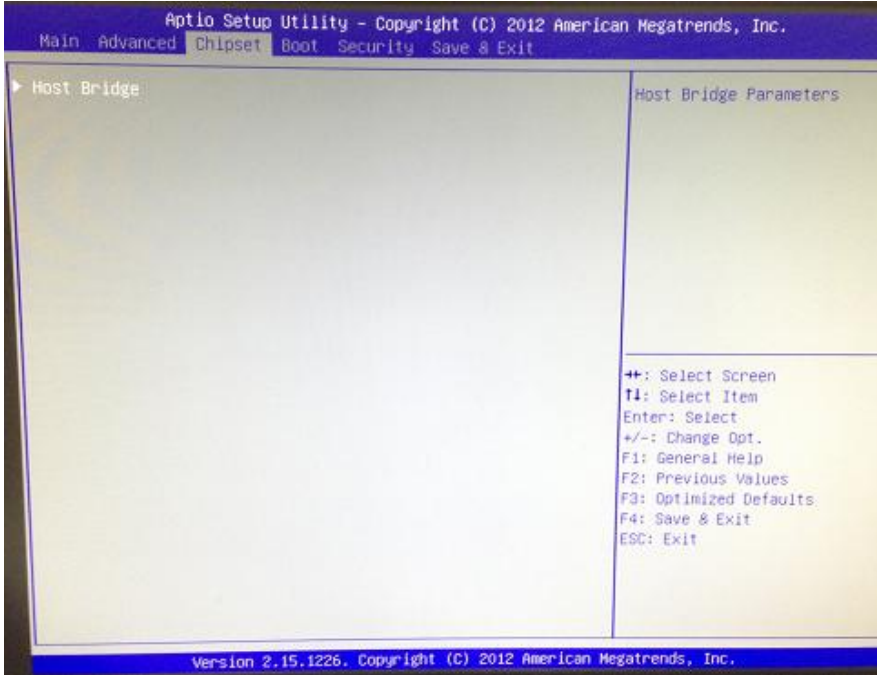

3.5 Boot Type

The Boot Option #1 is SSD (or HDD).

The Boot Option #2 is CF.

The Boot Option Priorities for the default setting is SSD (or HDD).

(Please refer below graphics.)

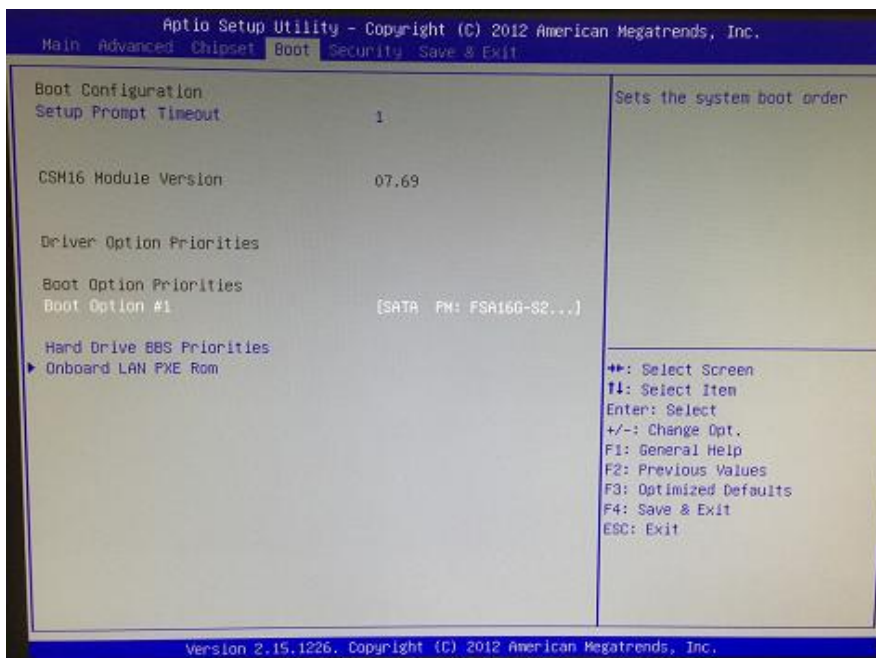
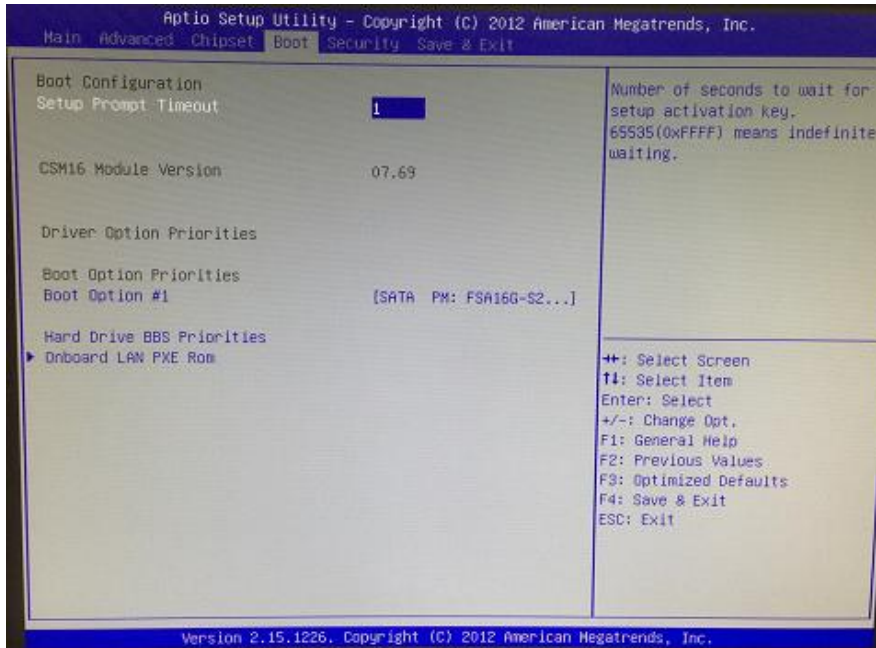

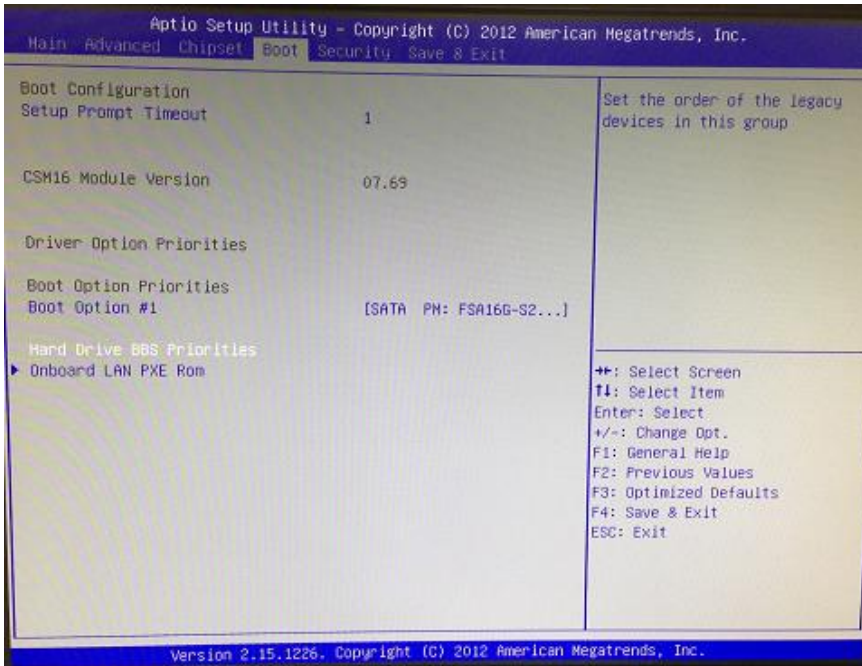
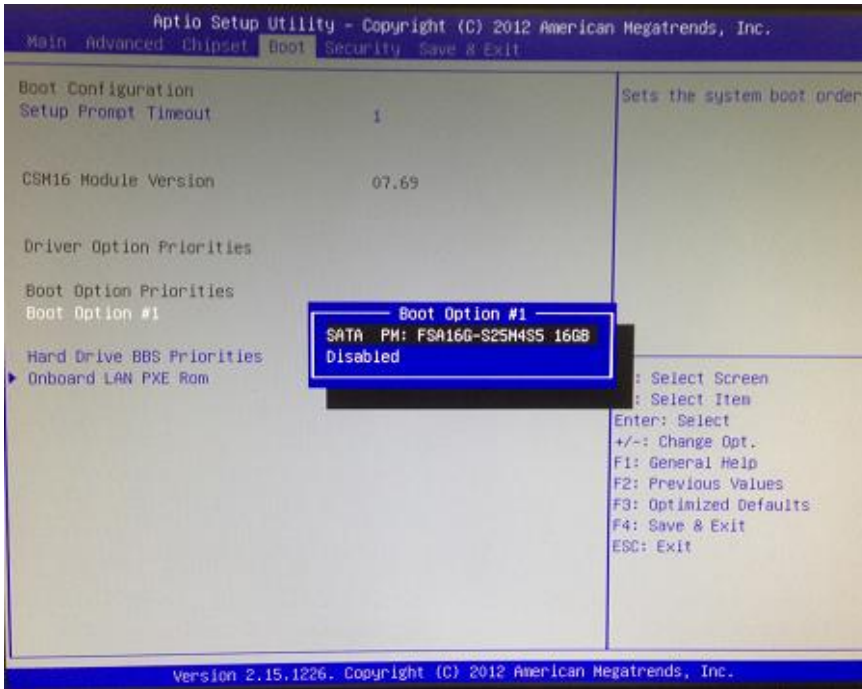

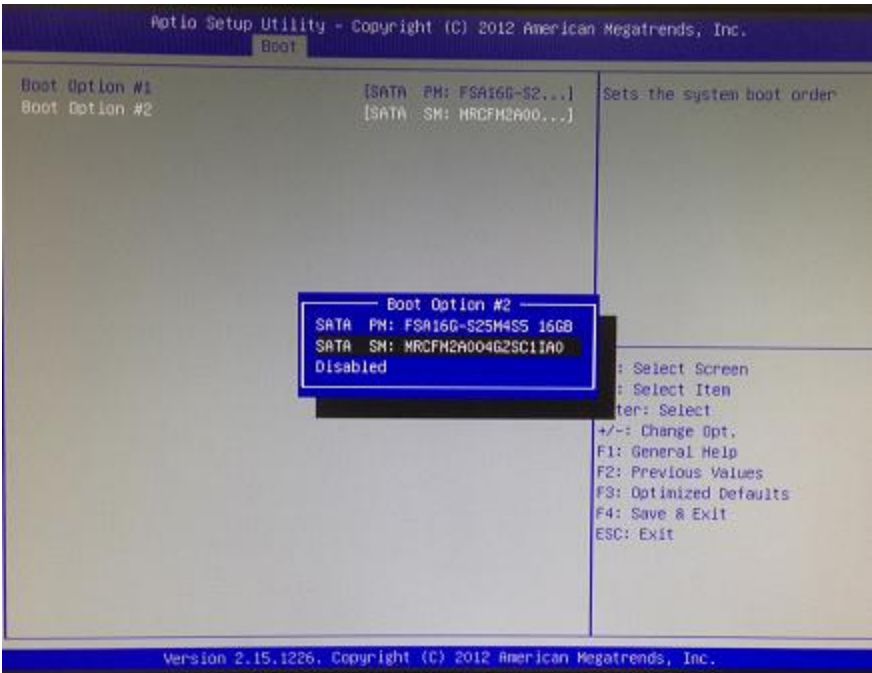

The default setting boot from onboard LAN PxE Rom is [Disabled]
(Please refer below graphics.)

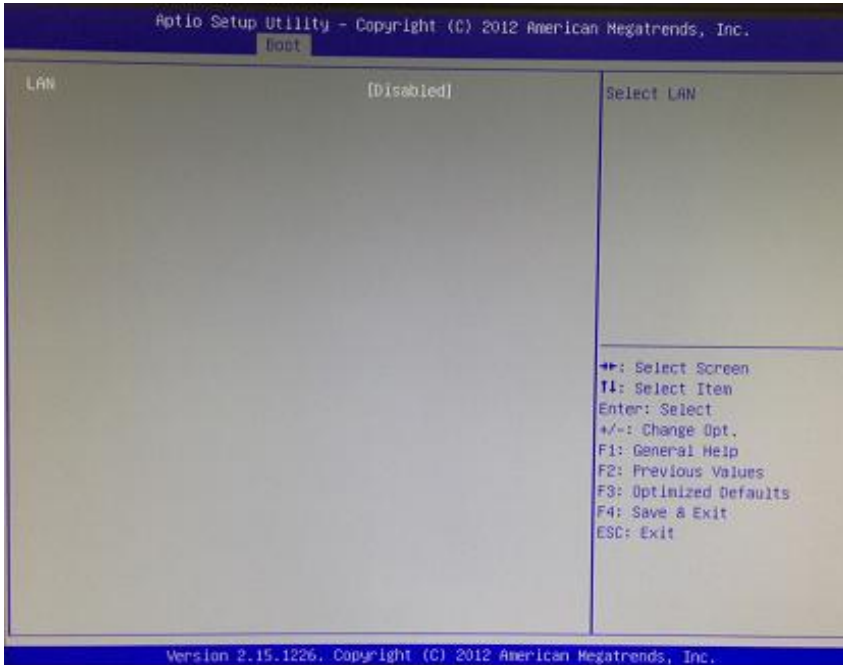
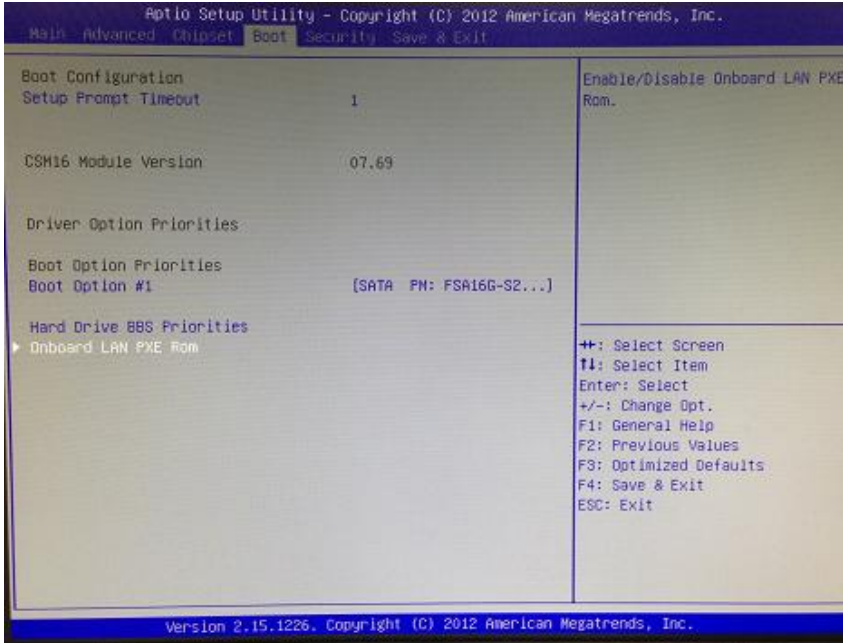



 **Note:** If system is power failure, the date and time will come back to previous setup.

3.6 Security

The default setting for Administrator Password is “Not setting passwords”.

The Security menu allows users to change the security settings for the system.

You can set the password for both Administrator Password and User Password.

When you select this function, the following message will appear at the center of the screen to assist you in creating a password.

Administrator Password

This item indicates whether an administrator password has been set (installed or uninstalled).

User Password

This item indicates whether an user password has been set (installed or uninstalled).

ENTER PASSWORD

Type a password according to the password length range between the minimum length for 3-character and the maximum length for 20-character, and press <Enter>. This typed password will clear previously entered password from the Aptio Setup Utility memory. You will be asked to confirm this password. Type this password again and press <Enter>. You may also press <Esc> to abort this selection and not enter a password.

To disable the password, just press <Enter> when you are prompted to enter a password. A message will confirm the password is getting disabled. Once the password is disabled, the system will boot and you can enter Setup freely.

PASSWORD ENABLED / DISABLED

When a password is enabled, you have to type it every time you enter the Setup. It prevents any unauthorized persons from changing your system configuration.

Additionally, when a password is enabled, you can also require the BIOS to request a password every time the system reboots. This would prevent unauthorized use of your computer.

You decide when the password is required for the BIOS Features Setup Menu and its Security option. If the Security option is set to “System”, the password is required during booting up and entry into the Setup; if it is set as “Setup”, a prompt will only appear before entering the Setup.

(Please refer below graphics.)

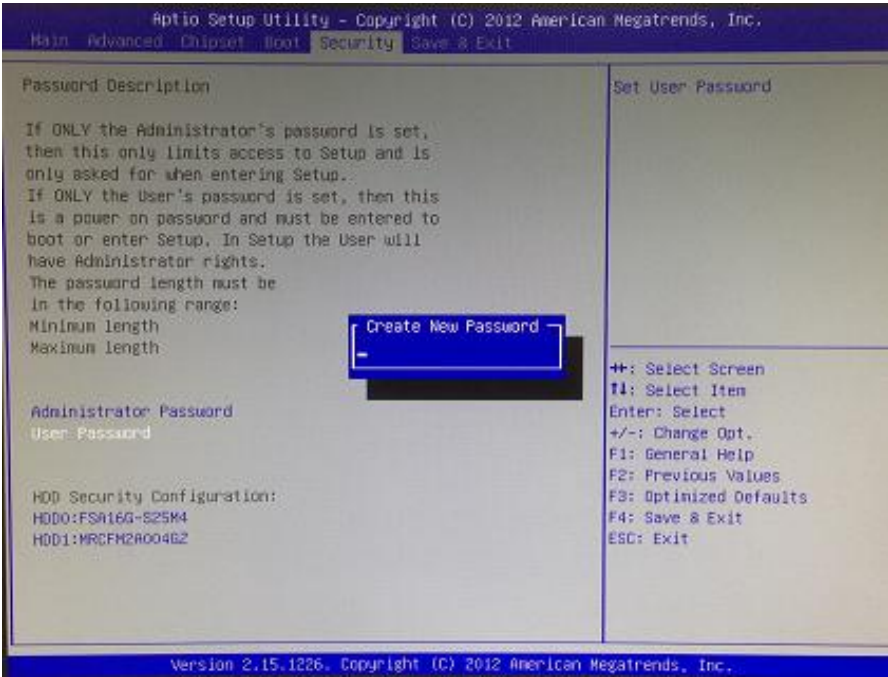
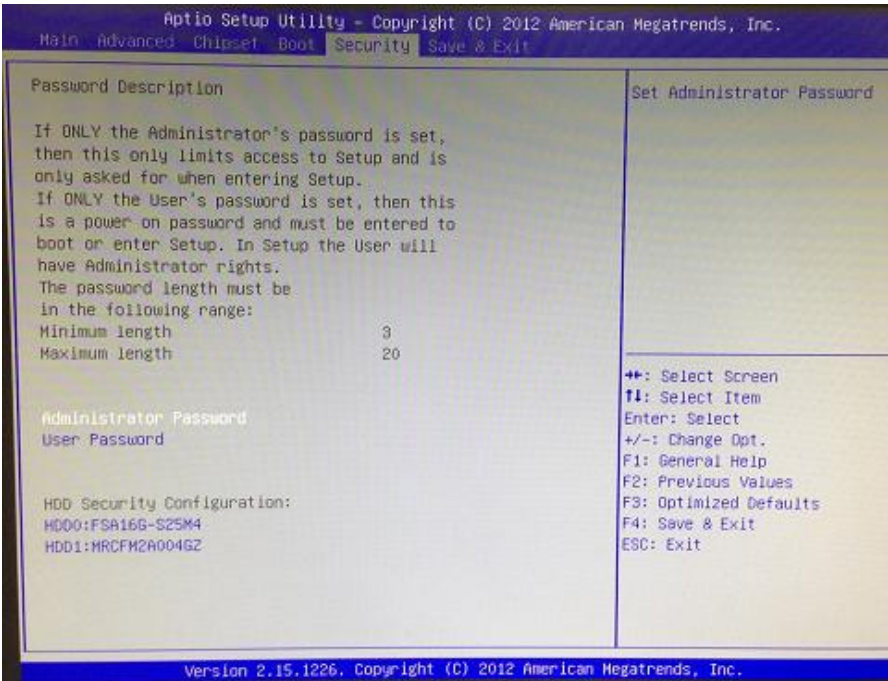

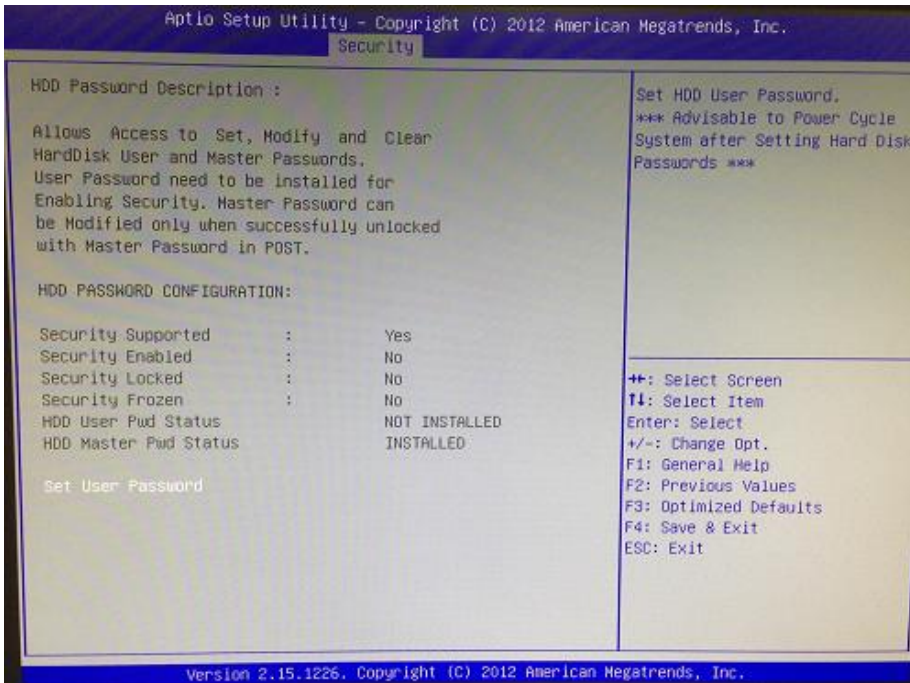
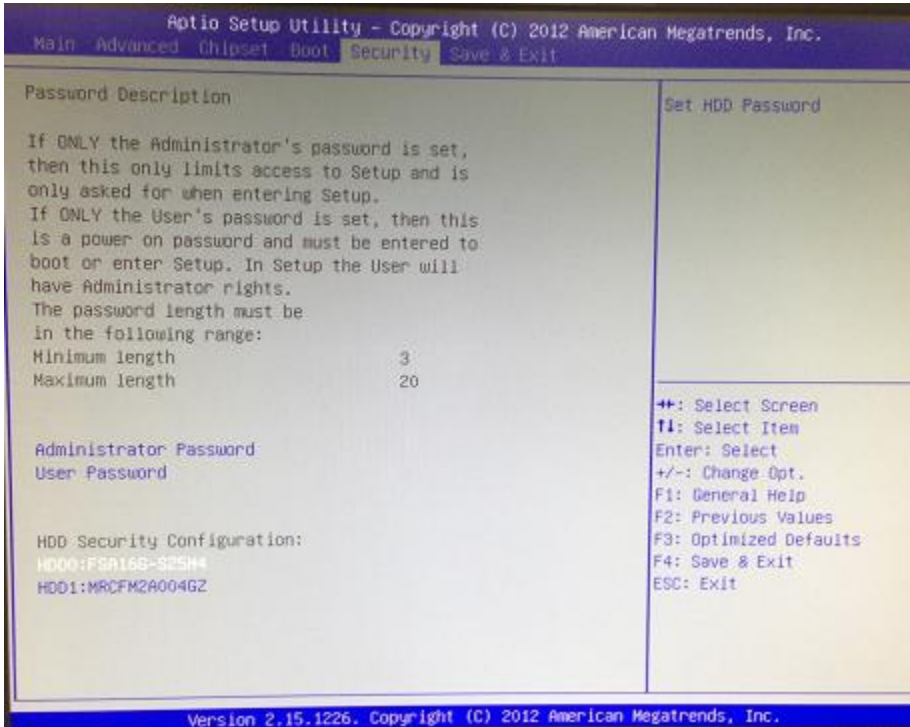

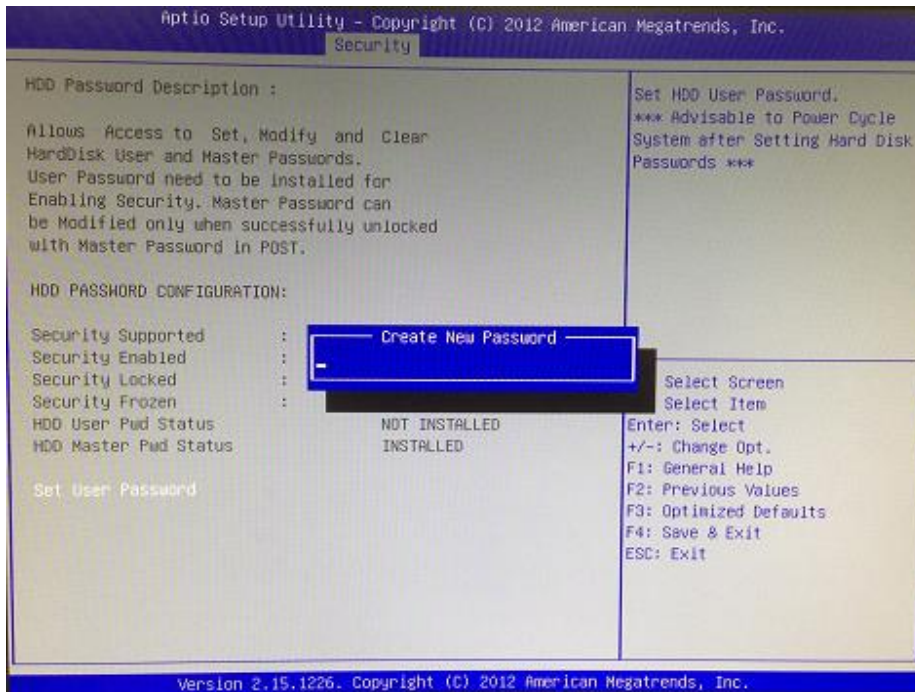

Note: The BIOS default has no password, when user created the password, please remember the password number, if users forget password the RMA is the only solution.

3.7 Save & Exit

This section allows you to determine whether or not to accept your modifications. Type “Y” to quit the setup utility and save all changes. Type “N” to bring you back to the Previous Setup utility.

Save Changes and Exit

When you have completed the system configuration changes, select this option to leave Setup and return to Main Menu. Select Save Changes and Exit from the Save & Exit menu and press <Enter>. Select Yes to save changes and exit.

Discard Changes and Exit

Select this option to quit Setup without making any permanent changes to the system configuration and return to Main Menu. Select Discard Changes and Exit from the Save & Exit menu and press <Enter>. Select Yes to discard changes and exit.

Save Changes and Reset

When you have completed the system configuration changes, select this option to leave Setup and reboot the computer so the new system configuration parameters can take effect. Select Save Changes and Reset from the Save & Exit menu and press <Enter>. Select Yes to save changes and reset.

Discard Changes and Reset

Select this option to quit Setup without making any permanent changes to the system configuration and reboot the computer. Select Discard Changes and Reset from the Save & Exit menu and press <Enter>. Select Yes to discard changes and reset.

Save Changes

When you have completed the system configuration changes, select this option to save changes. Select Save Changes from the Save & Exit menu and press <Enter>. Select Yes to save changes.

Discard Changes

Select this option to quit Setup without making any permanent changes to the system configuration. Select Discard Changes from the Save & Exit menu and press <Enter>. Select Yes to discard changes.

Restore Defaults

It automatically sets all Setup options to a complete set of default settings when you select this option. Select Restore Defaults from the Save & Exit menu and press <Enter>.

Save as User Defaults

Select this option to save system configuration changes done so far as User Defaults. Select Save as User Defaults from the Save & Exit menu and press <Enter>.

Restore User Defaults

It automatically sets all Setup options to a complete set of User Defaults when you select this option. Select Restore User Defaults from the Save & Exit menu and press <Enter>.

Boot Override

Select a drive to immediately boot that device regardless of the current boot order.

(Please refer below graphics.)

