

**NEXO**  
INNOVATE

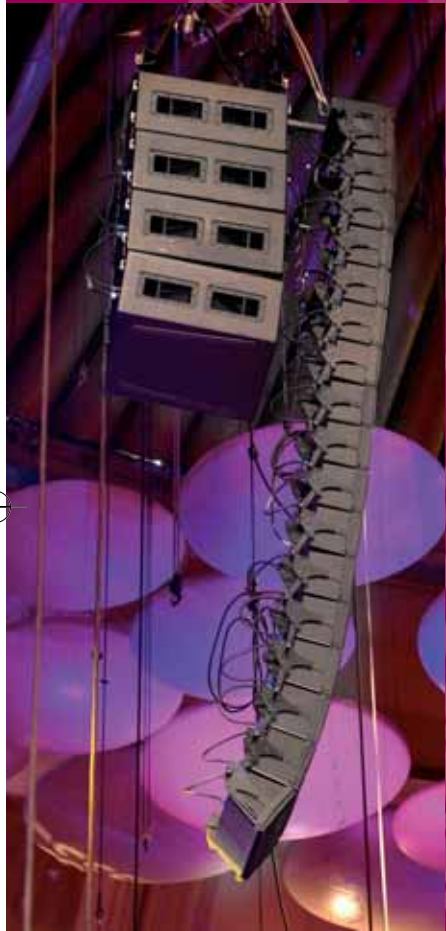

NEXO S.A.  
154 allée des Erables  
ZAC de PARIS NORD II B.P. 50107  
F-95950 Roissy CDG CEDEX  
France  
Tél: +33 1 48 63 19 14  
Fax: +33 1 48 63 24 61  
eMail: info@nexo.fr

Americas  
NEXO USA, Inc  
2165 Francisco Blvd. East  
Suite E2  
San Rafael, CA 94901-5522  
USA  
Tel: +1 415 482 6600  
Fax: +1 415 482 6110  
eMail: info@nexo.cc

Latin America  
Tel +1 305 677 9322  
Fax +1 360 234 7870  
Email: info@nexo.fr

[www.nexo-sa.com](http://www.nexo-sa.com)

**LIMITED WARRANTY**

NEXO loudspeakers and electronics are covered against defects in workmanship or materials for a period of two (2) years from the original date of purchase. At the option of NEXO the defective item will be repaired/replaced with no charge for materials/labour. The item is to be adequately packaged and dispatched, pre-paid, to a NEXO authorised distributor/service centre. Unauthorised repair shall void the warranty. The NEXO warranty does not cover cosmetics or finish and does not apply to any items which in NEXO's opinion have failed due to used abuse, accidents, modifications or any type of misuse. All images and text herein are the property of NEXO SA, and deemed accurate, although specifications are subject to change without notice.

**NEXO**  
INNOVATE



Geo7

Geo5

SUB-BASS

NX242





**CONTENTS**

NEXO and the Genesis of GEO systems 2  
 Introduction to GEO S and GEO T 3  
 GEO Tangent Systems Technology 4  
 GEO Tangent Systems Performance 5  
 GEO T4805 module 6  
 T 4805 Technical & Architect Specs 7  
 GEO T2815 Module 8  
 T 2815 Technical & Architect Specs 9  
 GEO T Connections and Arrays 10  
 GEO & CD Rigging, Flying & Focus 11  
 GEO S805 module 12  
 S805 Technical & Architect Specs 13  
 GEO S830 module 14  
 S830 Technical & Architect Specs 15  
 GEO S Rigging & Horizontal Arrays 16  
 GEO Soft 17  
 GEO CD18 Sub-Bass 18  
 CD18 Technical & Architect Specs 19  
 Geo CD12 Sub-Bass 20  
 CD12 Technical & Architect Specs 21  
 NX242 Digital Controller 22  
 NX242 Technical Specs 23  
 NEXO Contact Data & www. address, NEXO Warranty 24

**SMALLER AND BETTER**

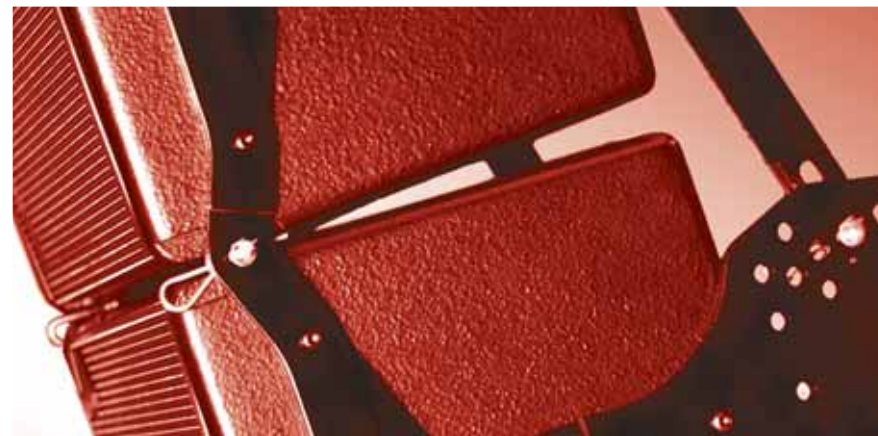

*Digital technology changed everything about audio and the music listening experience. Beyond obvious improvements in system performance, the greatest change was in expectations. Modern audiences compare live event sound with affordable, pristine personal or residential playback systems and, in doing so, add "fidelity" as a live concert requirement. Today's audiences expect a CD-quality mix from a concert PA, only on a "bigger" scale than at home, and without significant fidelity loss.*

**NEXO S.A.**

Now in its fourth decade, NEXO's company mission is to provide wide-ranging solutions that enhance the science, art and commerce of sound reinforcement. Founded by Michael Johnson, NEXO's Managing Director, and Chairman/R&D Director Eric Vincenot, NEXO became a publicly traded company in May 2000. NEXO shares are listed on the Marche Libre of the Paris Bourse (SICOVAM 4441).

The added access to capital markets gained by this public offering strengthened NEXO's ability to pursue aggressively genuine audio innovations. The first of these advanced audio design options is the widely heralded GEO Tangent technology, which incorporates several fundamental wave-source patents.

NEXO's sound reinforcement systems also include the compact, versatile PS Series plus the high performance Alpha System and Alpha<sup>®</sup> Series. In short, all NEXO loudspeakers, analogue and digital controllers, power amplification, and advanced rigging systems are designed to deliver: Sonic Innovation That Works. NEXO is a world leader in the design and manufacture of loudspeaker systems for sound reinforcement.

*In the 1990s the film industry used digital audio to deliver a "bigger and better" challenge to the comparatively tame at-home video experience. Movie seats were suddenly filled again, reversing decades of declining film revenues. Steady sales growth in home theater systems only reinforces the fact that people will pay for "bigger and better", especially when the emphasis is on better. NEXO innovation has taken this trend to its logical conclusion. With GEO, we offer sound reinforcement systems that are smaller and better. We think of it as a win-win solution, without compromise.*

**COHERENCY, TRANSPARENCY, FIDELITY**

Today, bigger sound is easy. Nearly every touring loudspeaker system offers overwhelming power and full-range frequency response. "Better" however, remains elusive, and the elusive component in "better" concert sound is coherency. Coherency is easily achieved in controlled, direct-field environment such as car stereos or MP3 earbuds. To a layman's ears, performance loudspeaker coherency is what happens when the rare concert makes them feel as they do when listening in their home or car, only much "bigger".

More common to our shared experience is the lack of coherency caused when loudspeaker systems create spectrum-wide, audible coloration (i.e. constant peaks or dips in frequency response). These tonal imbalances inevitably leave dissatisfied audiences as aware of sound system performance as they are of the on-stage performance. This is why transparent, coherent sound reinforcement is the overriding design criteria behind GEO S and GEO T.

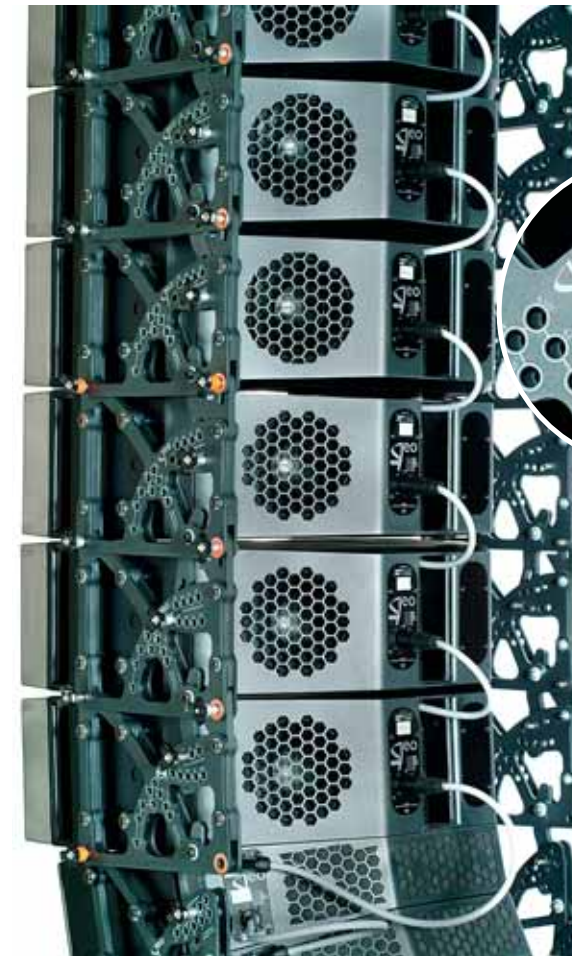

Above: Infinitely precise rigging hardware maximizes the coherency of GEO's wavefront.

**TIME, SPACE, FREQUENCY**

Coherency applies to sound system transparency in the three-dimensional context of Time, Space and Frequency. At issue are Comb Filters, the audible, undesirable sound system artifacts caused by closely-spaced peaks and notches in the frequency domain, and multiple arrivals in the time domain with very short time differentials and similar amplitudes. As multiple arrivals become widely separated in time (and space), coherency is lost. Meanwhile frequency response displays wide peaks and dips which change depending on spatial positioning of the listener and sound sources.

Most naturally occurring sound sources however, such as unamplified singers or instrumentalists, never present listeners with multiple arrivals (i.e. comb filters). As such, human hearing never evolved to interpret amplified sounds, and our ear-to-brain connections never adapted to the relatively modern comb filter. Moreover, even when comb filters seem comparatively "fine" and not clearly audible, they continue to make it difficult to "hear what is going on." This is especially true for HF percussive sounds or vocal consonants.

No electronics will fix this situation. A whole-system EQ curve can never really "flatten" these peaks and dips. At some locations and certain frequencies, equalization will actually make things worse. At others, presumably FOH, it might make them better. Only true system coherency will allow engineers to execute effective tonal adjustments that will work at every seat and for every pair of ears. This is why, at NEXO, our pursuit of coherency drove the three years of R&D that delivered GEO. We're extremely proud of the results.

**TOTAL COHERENCY**

*GEO S Array (as rigged at left)*  
 8X GEO S805  
 1X GEO S830  
 2X CD12

*Total Length: 2.15m (7.05ft)*  
*Total Width: 600mm (1.96ft) (at front)*  
*Total Weight: 193kg(414.6lbs)*  
**NOTHING ELSE COMPARES**



INNOVATE

www.nexo-sa.com



# GEO SCIENCE & SOLUTIONS

GEO HRW (reflective) Wavesources are:

- Very accurate
- Extremely compact
- Capable of Perfect Array Coupling Through combining Wavefronts
- Exceptionally versatile

## MEASUREMENT CONFIRMED

To realise coherency, our most pressing design challenge was development of a sound system that allowed a multiple full-range cabinets to behave as if they share a single sound source. Obviously, this required acoustic coupling between multiple cabinets, but GEO Technology goes far beyond traditional line arrays. In fact, had we not been able to achieve coherency beyond the mid-to-HF coupling inherent in nearly every existing line array, NEXO would never have entered the vertical array marketplace.

The point is that a Brüel and Kjaer Acoustic Analysis system doesn't care what system you place in front of its calibration microphone. Nor does advanced MATLAB software care what data you feed it. So, when these advanced measurement tools confirmed that GEO S and GEO T loudspeaker systems displayed superior sonic performance that exceeded even our rigorous standards, it was clear that GEO's unique wavesource had redefined control of acoustic energy. Simply put, GEO's hyperboloid acoustic reflector eliminates destructive interference, with the most coherent output of any loudspeaker, anywhere.



Fig 1: Computer Rendered, GEO S805 Wavesource



Photo1: GEO S Wavesource with Configurable Directivity Device flanges.

Fig 2 (below left): HRW creates a virtual acoustic wavesource that is "outside" the loudspeaker cabinet.

## THE GEO HYPERBOLOID REFLECTIVE WAVESOURCE™

Hyperboloid Reflective Wavesource (HRW™) technology produces precise and predictable results so that GEO wavesources couple optimally without destructive interference. This is why the GEO rigging system is designed to control angular splay to 0.01° precision.

The key to GEO's success however is in the innovative method that the HRW uses to control acoustic energy so that users can craft high-output wavefronts to precisely fit audience areas, more coherently and more evenly, than previously possible.

The HRW wavesource (see Figure 1 & Photo 1) controls acoustic energy with an acoustical reflector (i.e. mathematically calculated hyperboloid acoustic mirror, derived from a rigorous set of geometrical transformations). Thus the HRW creates a virtual acoustic wavesource that is "outside" the loudspeaker cabinet (see Figure 2).

This patent-pending technique allows the designer to locate the real source (the compression driver) almost anywhere inside the

enclosure. It also provides a virtual source that is behind the rear of the enclosure. As such, GEO wavesource measurements display a high degree of correspondence between mathematical predictions and real world results.

## HOW IT WORKS

As mentioned, GEO devices can use a HRW to position a virtual sound source "behind" the physical enclosure (see Figure 2). Notice that the path lengths from the virtual and real sources, to the horn mouths, are identical at the coupling points.

This is the critical concept. Where the two wavefronts touch they will therefore be in phase because the pressure wave takes the same amount of time to travel an identical path length to the coupling point, regardless of where its real source is located in relation to that coupling point.

This was difficult to achieve and not the only technical challenge involved. Several other design obstacles also had to be overcome. For example, GEO S uses 8-inch cone woofers and 1 inch compression drivers, so we need to operate

the woofer up to at least 1200Hz.

In practice, we can't expect to centre 8-inch woofers closer than 10 inches, otherwise they will be a full wavelength apart at 1300Hz and adjacent woofers will start to become separate sources at 325Hz (1/4 wavelength spacing) and will begin to develop individual lobes at 625Hz. This frequency is far too low to cross over into the compression driver.

The solution was GEO's Directivity/Phase Device (DPD) (see Photo 3) on each cone, which causes 8-inch woofers to behave like twin 4-inch drivers with two acoustical centres spaced 5 inches. The DPD extends the upper frequency limit for line source coupling between adjacent woofers. As such, GEO system's 8-inch



Photo 3: GEO S Directivity Phase Device

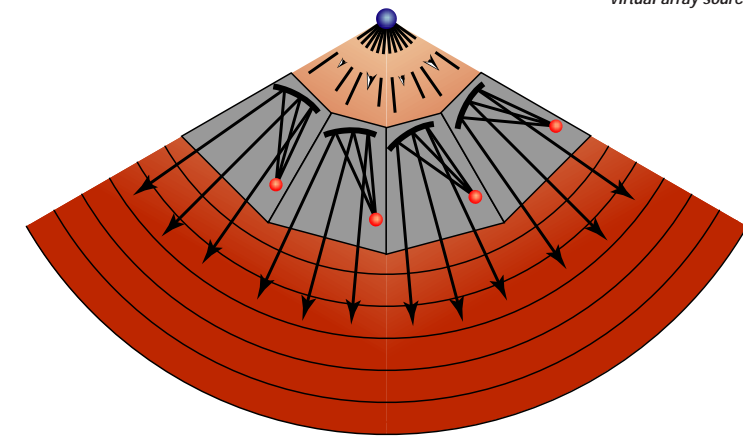

Photo 4: GEO T Directivity Phase Device

cone driver loses neither power handling, nor LF extension. In the GEO S Series, the DPD takes the form of a phase plug that is attached to the frame of the cone transducer. In the GEO T Series, the DPD is part of the molding that also includes the Configurable Directivity Device (see Photo 4).

Also, because GEO T uses two 8-inch cone woofers and 1-inch compression drivers, the GEOT woofer must operate up to at least 1200Hz. As such, GEO T's LF coupling performs in nearly identical fashion to non-cardioid arrays, in that our smaller arrays have proportionally more bass than large ones, because the LF interfering effects are much smaller.

Fig 2: Coherency through GEO Wave Propagation. Tangent wavefronts radiate from common virtual array source.



One other GEO innovation that must be mentioned is the Configurable Directivity Device flanges (CDD). (see Photo 1) An unprecedented NEXO development that is easy to use once you know how and when, these devices allow system designers, especially those working on permanent installations, to precisely alter wavesource behaviour.

GEO S Series loudspeakers ship with the flanges (120° dispersion in the non-coupling plane). In curved vertical arrays, CDD flanges can be used on the bottom two rows of curved vertical arrays, in cases where 120° of horizontal coverage is preferred to 80°. In horizontal arrays of GEO S830s, the Configurable Directivity Device can be used to widen the array's vertical coverage of from 80° to 120°.

## BIG PICTURE

A GEO Tangent Array is not a "line array" GEO Technology is equally effective in designing and deploying tangent horizontal arrays or curved vertical arrays. For best results in a specific application most users need to know how multi-speaker arrays interact with audience geometry, along with the benefits and drawbacks of curved vertical arrays and horizontal arrays.

The cardioid works in the vertical as well as the horizontal plane and it is therefore pretty obvious that the effect will be much more impressive in a small array. As the array becomes larger/longer (and most often flatter as a consequence of its length) the HF couples very effectively and becomes more prominent than the LF, while LF increases nearly proportionally to the quantity of cabinets, without the need for extensive LF equalisation.

## THE SUB-BASS SOLUTION

While bringing coherency and cardioid performance to LF was a challenge, cardioid or hypercardioid control of extreme LF or sub-bass was the capstone of GEO system design. To achieve this we looked toward input transducer (i.e. microphone) design.

Microphones have long offered cardioid polar patterns. As such, cardioid loudspeakers can be simply described as a "cardioid mic in reverse". NEXO's approach uses the interference between two arrivals of the same amplitude in order to create off-axis rejection with rear reduction as high as -15dB. We apply the interference between two sources of identical amplitude to radiate a cardioid polar pattern with off-axis attenuation (see Fig 3).

To achieve this, NEXO R&D designed advanced electronic control algorithms to allow NX242 TDcontrollers to maximise SubBass pattern control for CD12 and CD18 cabinets. For more information regarding sub-bass control please see pg 20. For more information on NX242 please see pg 22.

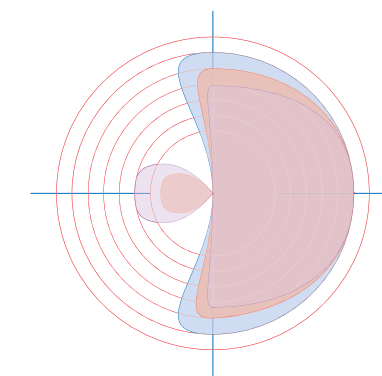

Fig 3: Cardioid sub-bass coverage from CD SubBass





**GEO T4805**

A compact, extremely high-output array module, the T4805 is the centerpiece to GEO T vertical tangent array system design. The 5° Hyperboloid Reflective Wavesource is optimized so that multiple GEO loudspeakers coherently radiate tangent wavefronts, allowing these curved vertical arrays to deliver consistent front-to-rear SPL across all coverage areas. Advanced DSP algorithms, applied by the NX242 TDcontroller, provide GEO T systems with unrivalled midbass directional control.



GEO T4805 rear view

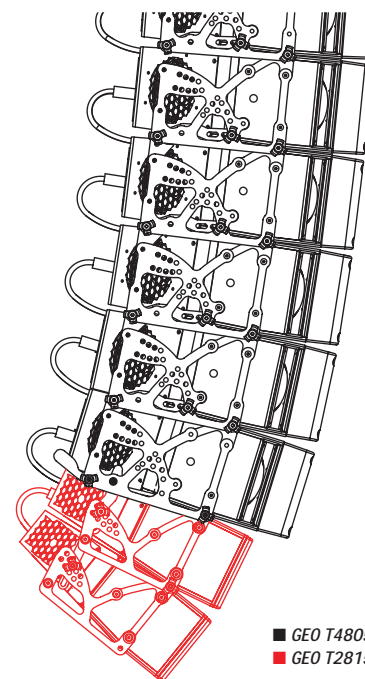
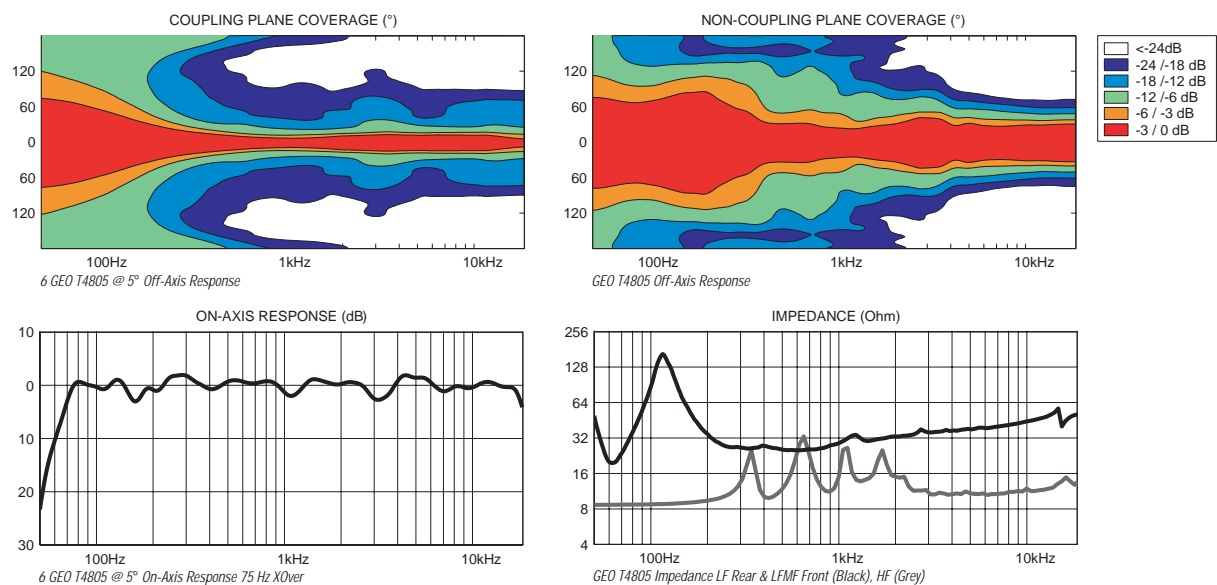

■ GEO T4805  
■ GEO T2815

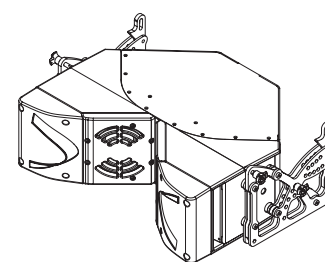
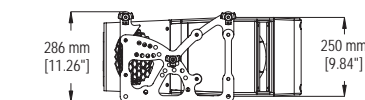
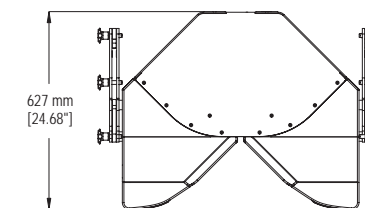
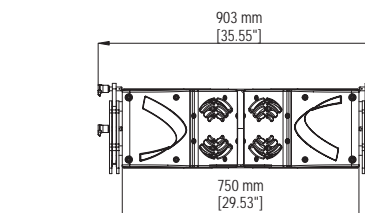

**GEO T4805 PRODUCT FEATURES**

Components	HF: 1 x 3" voice coil, 1.4" throat neodymium 16Ω driver on a Hyperboloid Reflective Wavesource. LF front section: 2 x 8" (20cm) neodymium hi-flux 16Ω drivers in series. LF back section: 2 x 8" (20cm) neodymium hi-flux 16Ω drivers in series.
Height x Width x Depth	Enclosure: 250 x 750 x 627mm (9 7/8" x 29 9/16" x 24 11/16") Array Module: 286 x 903 x 627mm (11 1/4" x 35 1/2" x 24 11/16")
Shape	5° Trapezoid.
Weight	52kg(114.6lbs) net, including flying system.
Connectors	1x AMPHENOL 6-pole EP6 socket In, 1x AMPHENOL AP6 6 pole cable + connector Through.
Construction	Baltic birch ply finish with structured black coating for the main structure. Metal box for the rear section with dark grey coating.
Front Finish	Injected polyurethane flange with metallic grey coating.
Flying Points	Integral flying system. Intercabinet angle adjustments = 0.125° to 5° (logarithmic steps).

**SYSTEM SPECIFICATIONS GEO T4805 with NX242 TDcontroller**

Frequency Response [a]	67Hz – 19kHz ± 3dB
Usable Range @-6dB [a]	60Hz – 20kHz
Sensitivity 1W @ 1m [b]	109dB SPL nominal – 107dB SPL wideband
Peak SPL @ 1m [b]	Configuration dependent [d].
Dispersion [c]	Coupling plane: not usable alone. Configuration dependent [d]. Non-coupling plane: 90°.
Crossover Frequencies	250Hz & 1.3kHz active
Nominal Impedance	LF rear: 32Ω - MF/LF front: 32Ω - HF: 16Ω
Recommended Amplifiers HF:	3000Watts into –32Ω/6 cabinets.
	MF/LF (front section): 6000Watts bridged mono into –6Ω/6 cabinets.
	LF (rear section): 6000Watts bridged mono into –6Ω/6 cabinets.

**SYSTEM OPERATION**

Electronic Controller	The NX242 Digital TDcontroller presets are precisely matched to the GEO T Series cabinets and include sophisticated protection systems. Using GEO T Series cabinets without properly-connected NX242 Digital TDcontroller will result in poor sound quality and can damage components.
Dispersion Configuration	The CDD is configured for 90° dispersion in the non-coupling plane.
Array Design	Via GEOSoft compiled Matlab application or EASE/CATT .dll (latest version available at www.nexo-sa.com).
Subbass	CD18 Supercardioid SubBass (requires two NX242 outputs and two amplifier channels).
Speaker Cables	LF rear: 1(-)/2(+)- LF/MF front: 3(-)/4(+)- HF: 5(-)/6(+).
Rigging System	Please refer to the GEO user manual before any operation.

**SHIPPING & ORDERING**

Packaging	T4805s are packaged individually or in groups of three in NEXO GEO T flight case. Order as GEO T4805 (includes 4x BLGEO12-30 quick release pins).
Shipping Weight & Volume	1x T4805 = 53.5kg(117.9 lbs), 0.15 cu m (5.3 cu ft)

As part of a policy of continual improvement, NEXO reserves the right to change specifications without notice. [a] Response curves and data: anechoic far field above 300Hz, half-space below 300Hz. [b] Sensitivity & peak SPL: will depend on spectral distribution. Measured with band limited pink noise. Refers to the specified ±3dB range. Data are for speaker + processor + recommended amplifier combinations. [c] Directivity curves and data: 1/3 octave smoothed frequency response, normalized to on-axis response. Data obtained by computer processing of offaxis response curves. [d]Please refer to the GEO T User Manual. Usable range data: frequency response capability with TD crossover slopes removed.

**ARCHITECT'S AND ENGINEERING SPECIFICATIONS**

The 3-way full range tangent array module shall have four 8", 16Ω long-excursion neodymium hi-flux cone transducers wired in series (two front-firing, two rear-firing), two 8", 16Ω long excursion neodymium hi-flux midrange cone drivers wired in series (four 8" drivers total) and a 1.4", 16Ω neodymium compression driver on a hyperboloid reflective wavesource. The system's coverage shall be configuration-dependent in the coupling plane. In the non-coupling plane it shall be 90°. The system's Directivity Index shall be configuration-dependent. Nominal Sensitivity shall be 109dB (107dB wideband). When driven by a NEXO NX242 Digital TDcontroller properly connected to amplification capable of delivering 6000 Watts into a 6Ω (nominal) load (6 cabinets per amplifier channel in parallel). The system shall be capable of 138dB peak SPL (for a single enclosure: configuration-dependent when arrayed), with a frequency response of 67Hz to 19kHz ±3dB (60Hz to 20Hz ±6dB). The system shall include an active and passive crossover with DSP algorithms for directional control of midbass. Electrical connections shall be made via one 6-pole AMPHENOL EP6 socket and one 6-pole AMPHENOL EP6 plug.  
The system shall weigh 52kg(114.6lbs) and have a tuned, ported 5° trapezoidal enclosure constructed of 18ply Baltic birch (midsection), aluminum (rear driver compartment), finished in structured black coating and having exterior dimensions no greater than 286mmH x 903mmW x 607mmD (111/4" x 35.5" x 24 5/8"). Exterior hardware shall include an integral array assembly system with logarithmic steps and 0.01° precision. Interior components shall be protected by an injection-molded polyurethane Configurable Directivity Device flange. The system shall be the NEXO GEO T4805 with a NEXO NX242 Digital TDcontroller. Other integrated loudspeaker/controller systems shall be acceptable, provided independent laboratory test results verify these specifications are equalled or exceeded.





### GEO T2815

A compact, extremely high-output array module, the versatile T2815 is often used at the bottom of T4805 vertical tangent arrays (see pg #9), and in traditional horizontal arrays. The 15° Hyperboloid Reflective Wavesource is optimized so that multiple T2815s coherently radiate tangent wavefronts, when used in curved vertical arrays, to deliver consistent front-to-rear SPL across all coverage areas. Twin rear-firing passive resistors provide exceptional, passive midbass directional control.



GEO T2815 rear view

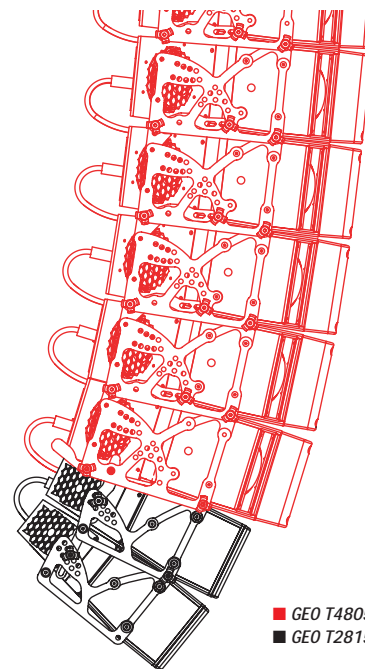

■ GEO T4805  
■ GEO T2815

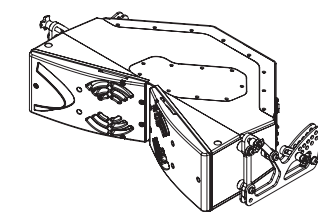
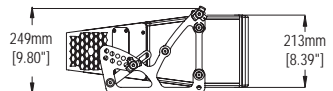
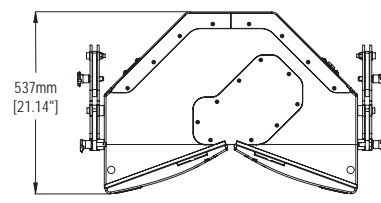
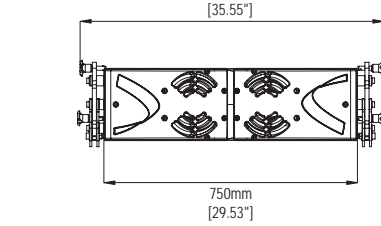
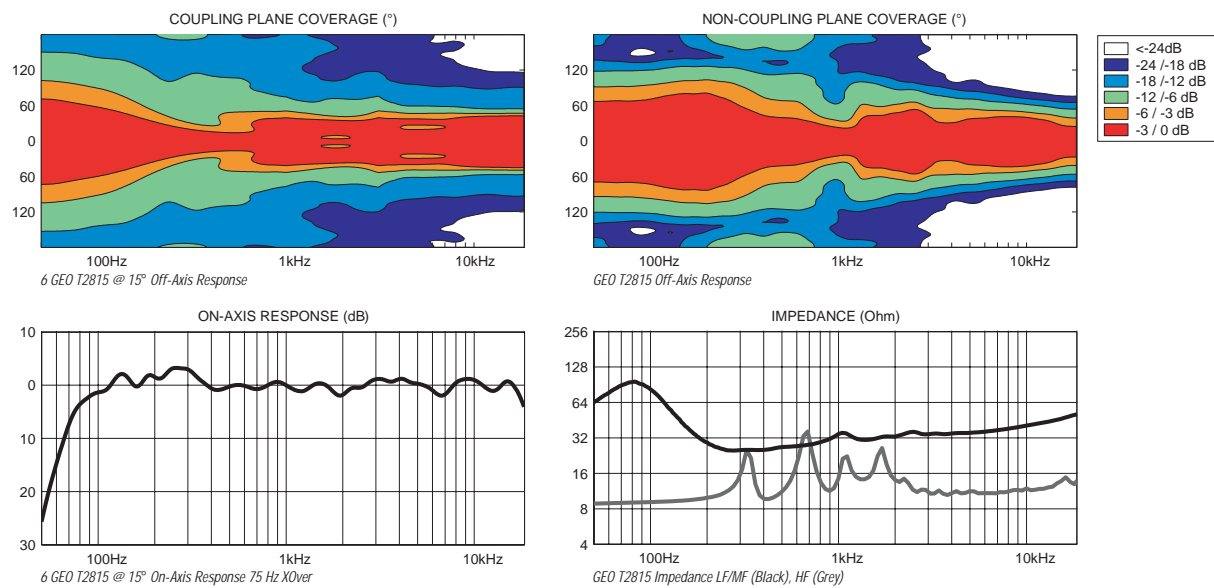

### GEO T2815 PRODUCT FEATURES

Components	HF: 1 x 3" voice coil, 1.4" throat neodymium 16Ω driver on a hyperboloid reflective wavesource. MF/LF (front-firing): 2x 8" (20cm) neodymium hi-flux 16Ω drivers in series. LF (rear-firing): 2x passive acoustic resistors
Height x Width x Depth	249 x 903 x 537mm (9 13/16" x 35 1/2" x 21 1/8") including array assembly system
Shape	15° Trapezoid
Weight	29kg (63.9 lbs) net, including array assembly system
Connectors	1x AMPHENOL 6-pole EP6 socket In; 1x AMPHENOL AP6 6-pole connector Through.
Construction	Baltic birch ply finish with structured black coating for the main structure. Metal box for the rear section, with dark grey coating.
Front Finish	Injected polyurethane flange, with metallic grey coating.
Flying Points	Integral flying system. Intercabinet angle adjustments = 0.125° to 5° (logarithmic steps).

### SYSTEM SPECIFICATIONS GEO T2815 with NX242 TDcontroller

Frequency response [a]	85Hz – 19kHz ±3dB
Usable range @ -6dB [a]	77Hz – 20kHz
Sensitivity 1W @ 1m [b]	107dB SPL nominal (105dB SPL wideband)
Peak SPL @ 1m [b]	Configuration dependent [d]
Dispersion [c]	Vertical plane. Configuration dependent [d]. 120° Low Frequency: Cardioid
Crossover frequency	MF/LF – HF (front): 1.3kHz active.
Nominal impedance	HF: 16Ω; MF/LF front: 32Ω.
Recommended amplifiers	HF: 3000Watts into ~3Ω (6 cabinets parallel per amp channel). MF/LF front section: 6000Watts into ~6Ω (6 cabinets parallel per bridged mono amp).

### SYSTEM OPERATION

Electronic Controller	The NX242 Digital TDcontroller presets are precisely matched to the GEO T Series cabinets and include sophisticated protection systems. Using GEO T Series cabinets without properly-connected NX242 Digital TDcontroller will result in poor sound quality and can damage components.
Dispersion Configuration	The CDD is configured for 120° in the non-coupling plane.
Array Design	Via GEOSoft compiled Matlab application or EASE/CATT .dll (latest version available at www.nexo-sa.com).
Subbass	CD18 Supercardioid SubBass (requires 2x NX242 outputs and two amplifier channels).
Speaker Cables	1(-)/2(+) NC - LF/MF front: 3(-)/4(+) - HF: 5(-)/6(+).
Rigging System	Please refer to the GEO user manual before any operation.

### SHIPPING & ORDERING

Packaging	T2815s are packaged individually or in groups of three in NEXO GEO T flight case. Order as GEO T2815 (includes 4x BLGEO12-30 quick release pins).
Shipping Weight & Volume	1x T2815 = 30.5kg(67.2lbs), 0.15 cu m (5.3 cu ft)

As part of a policy of continual improvement, NEXO reserves the right to change specifications without notice. [a] Response curves and data: anechoic far field above 300Hz, half-space below 300Hz. [b] Sensitivity & peak SPL: will depend on spectral distribution. Measured with band limited pink noise. Refers to the specified ±3dB range. Data are for speaker + processor + recommended amplifier combinations. [c] Directivity curves and data: 1/3 octave smoothed frequency response, normalized to on-axis response. Data obtained by computer processing of offaxis response curves. [d] Please refer to the GEO T User Manual. Usable range data: frequency response capability with TD crossover slopes removed.

### ARCHITECT'S AND ENGINEERING SPECIFICATIONS

The 2-way full range tangent array module shall have two 8" long-excursion neodymium hi-flux cone transducers wired in series and a 1.4", 16Ω neodymium compression driver on a hyperboloid reflective wavesource. The system's coverage shall be configuration-dependent in the coupling plane. In the non-coupling plane it shall be 120°. Nominal Sensitivity shall be 107dB (105dB wideband). When driven by a NEXO NX242 Digital TDcontroller properly connected to amplification capable of delivering 6000Watts into a 3Ω (nominal) load (6 cabinets per amplifier channel in parallel). The system shall be capable of 138dB peak SPL (for a single enclosure: configuration-dependent when arrayed), with a frequency response of 85Hz to 19kHz ±3dB (77Hz to 20kHz ±6dB). The system shall include an active and passive crossover, although directional control of midbass coverage is passive. Electrical connections shall be made via one 6-pole AMPHENOL EP6 socket and one 6-pole AMPHENOL EP6 plug. The system shall weigh 29kg(63.9lbs) and have a tuned, ported 15° trapezoidal enclosure constructed of 18ply Baltic birch (midsection), aluminum (rear driver compartment), finished in structured black coating and having exterior dimensions no greater than 249mmH x 903mmD (9 13/16" x 35.5" x 21 1/8"). Exterior hardware shall include an integral array assembly system with logarithmic steps and 0.01° precision. Interior components shall be protected by an injection-molded polyurethane Configurable Directivity Device flange. The system shall be the NEXO GEO T2815 with a NEXO NX242 Digital TDcontroller. Other integrated loudspeaker/controller systems shall be acceptable, provided independent laboratory test results verify these specifications are equalled or exceeded.





**GEO T SERIES ARRAY ASSEMBLY SYSTEM**

No portable loudspeaker system, intended for the ups and downs of touring sound, is really road-worthy without a quick and user-friendly flying and transport system. We believe our GEO T Series Array Assembly System (TSAAS) to be the most elegant and quite likely the fastest rigging system available.

Our system enables various system configurations to be flown with a minimum quantity of motor hoists. Most importantly, the TSAAS's custom-designed permits easy deployment while being functionally optimised to match precisely the mechanical and acoustical characteristics of GEO T2815 and GEO T4805 Array Modules.



GEO T4805 ships with TSASS Rigging Hardware



GEO T2815 ships with TSASS Rigging Hardware



Photo 1 (above): Connecting two GEO T4805s with integral cabling and Amphenol EP6 connector

**VERTICAL ARRAYS**

Vertical and horizontal arrays are unique in their behaviour and intended applications. Vertical GEO arrays are intended for applications where the horizontal coverage (GEO S 80° or 120°, or GEO T 90°) is suitable and even SPL from the first row to the last row of the audience is desired (everywhere).

Properly deployed, GEO Series systems can provide extremely even SPL throughout the depth of your audience, including balcony coverage.

**HORIZONTAL ARRAYS**

Horizontal arrays deliver equal power to equal angles, with SPL decreasing as distance increases. Horizontal arrays of GEO S830 and GEOT 2815 cabinets provide exceptional control of horizontal coverage but are not intended to provide the same even SPL capability as a GEO tangent vertical array.

For more information see pg # 16.

**FLYING VERTICAL**

The GEO T Series Array Assembly System requires three experienced persons for set-up: typically one motor hoist operator, and one GEO T operator per side of the cluster. When properly used and maintained, TSAAS will provide many years of reliable service. Vertical angle adjustment between cabinets has been limited to specific settings to ensure coherent acoustic coupling.

There are 5 main parts to the Geo T flying system:

1. The main flying bumper
2. The main helping beam
3. The GEO T cabinets
4. The helping plate or lower pull up assembly
5. The helping chain and clutch assembly

Each GEO T Array Module includes an individual rigging system, which is factory-mounted by NEXO. GEO T Series Tangent Array Modules are transported pre-pinned in a flight case of three cabinets (see photo 2).

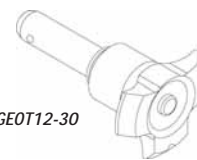

Fig 3: BLGEOT12-30

Six BLGEOT12-30 locking pins (see Figure #1) are provided with the GEO T4805 and four BLGEOT12-30 locking pins are provided with the GEO T2815. All holes on GEO T side rigging plates are 12mm diameter, and match the 12mm diameter x 30mm length pins.

**PRECISION FOCUS - HOW IT WORKS**

Because GEO T arrays require very high accuracy, angle sequences follow a logarithmic scale. Angle setting values are:  
 Bumper to GEO T4805: 0°  
 GEO T4805 to GEO T4805: 0.125° - 0.20° - 0.315° - 0.50° - 0.80° - 1.25° - 2.0° - 3.15° - 5.0°  
 GEO T4805 to GEO T2815: 6.30° - 8.00° - 10.0°  
 GEO T2815 to GEO T2815: 6.30° - 8.00° - 10.0° - 12.5° - 15°

TSASS deploys in either Tension mode or Compression mode (see Figure 4). In Tension Mode, angles between cabinets are set by the force of gravity applied from top to bottom of the array. When the array is lifted into position, each module will fall automatically into the proper angle.

In Compression Mode, angles between cabinets are set by a pull-back force applied from bottom to top of the array. When the array is lifted into position, all cabinets are at 0°, and when the pull-up force is applied, each module is lifted from the rear into the proper angle(see Figure 5).

**CD18 RIGGING**

Compared to the precise aiming required by GEO T arrays, CD18 SubBass rigging is relatively simple. Each CD18 is designed to stack directly on top of and/or below another CD18. The vertical stacks are required to realize maximum LF performance, and of course, there is a front and rear to each CD cabinet.

Although flying rigging is available for CD 18s, they are most frequently stage/ground stacked. To maximize CD18, or CD12 ground-stacked cardioid characteristics, a free (open)



Photo 2 (above): GEO T4805s packed in castered flightcase

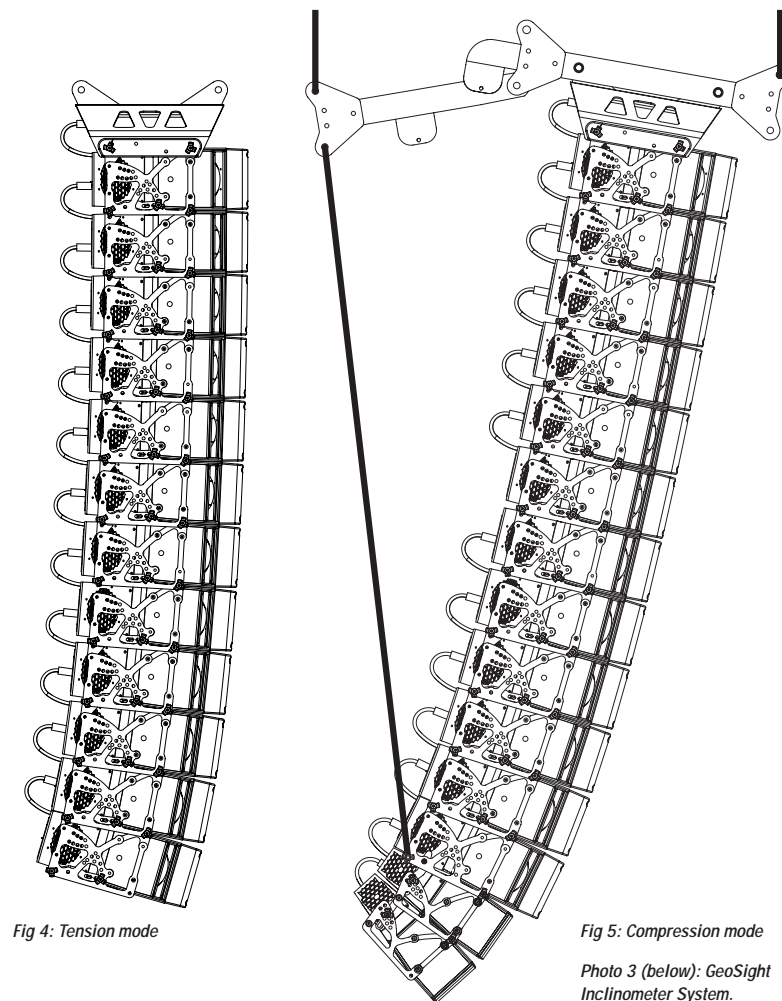

Fig 4: Tension mode

Fig 5: Compression mode

Photo 3 (below): GeoSight Inclinometer System. (cabling not shown)



space is needed directly behind the SubBass stack. Therefore, whenever possible, users should avoid placing the devices against any rear barriers such as back walls or staging barriers.

**TRANSPORT**

As mentioned, the GEO T Series cabinets travel conveniently, in groups of three, when packed in NEXO-provided castered flight cases.

Although relatively compact, the CD18 is too large for individual flight cases, and as such requires its own castered wheelboard for easily handling.

**GEOSIGHT INCLINOMETER**

As a high-performance, optics-derived system, successful GEO T deployment requires precise focus (i.e. aiming). Experienced users often apply laser-aiming procedures once their GEO T system is airborne.

The NEXO GeoSight Inclinometer System was specifically designed for installation of NEXO Geo Tangent Array Series systems. While not the only method of achieving a coherent wavefront, proper GeoSight use enables accurate GEO T array installation in minimum time. Visit our website at [www.nexo-sa.com](http://www.nexo-sa.com), or contact your NEXO agent, for more GEOSight information.

This brochure text is not intended as a rigging user manual, but rather to provide the general system details used in GEO T system rigging. The GEO T Array Assembly System is a professional precision tool and should be handled with extreme care. Only persons who are fully conversant with the operation of the GEO T Series Array Assembly System and provided with suitable safety equipment should install and operate the system. Misuse of the GEO T Series Array Assembly System could lead to dangerous consequences. Also there are several potential dangers: we won't list all of them here. We will mention possibly the most important operational warning: never put your fingers into the side rigging plates!



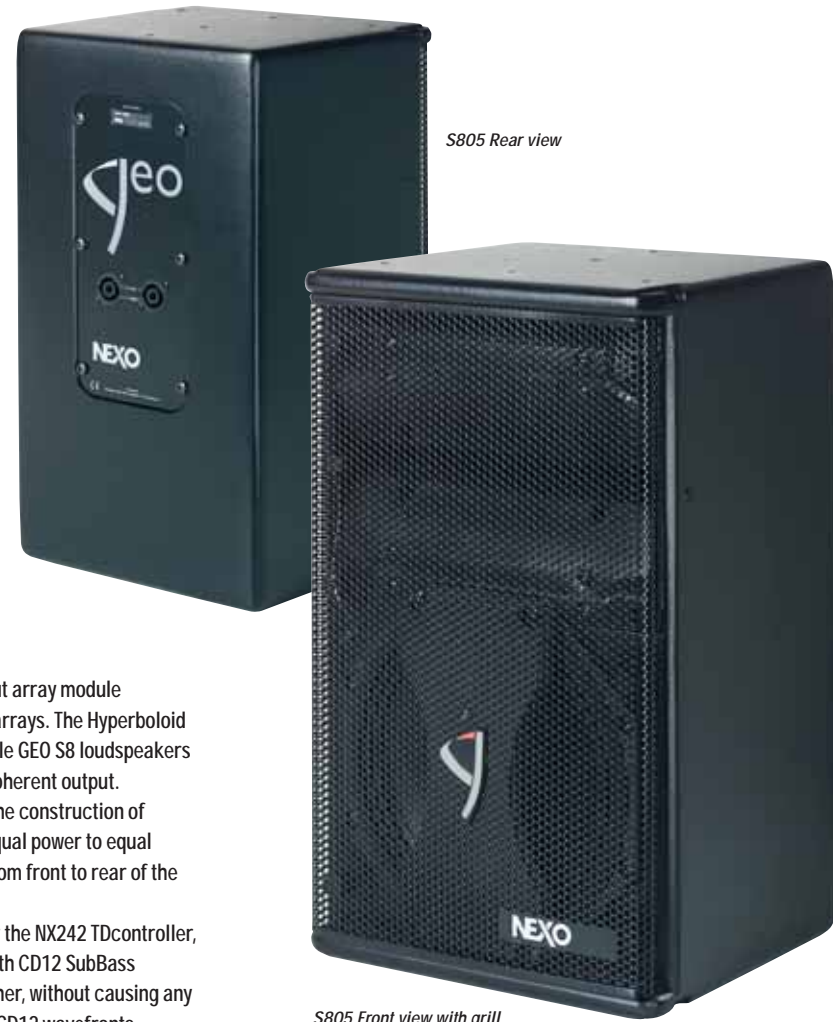

S805 Rear view

S805 Front view with grill

**GEO S805**

The GEO S805 is compact, high-output array module designed for use in vertical tangent arrays. The Hyperboloid Reflective Wavesource allows multiple GEO S8 loudspeakers to radiate tangent wavefronts with coherent output. The 5° wavesource is optimized for the construction of curved vertical arrays that deliver equal power to equal coverage areas for consistent SPL from front to rear of the audience area.

Advanced DSP algorithms, applied by the NX242 TDcontroller, precisely integrate GEO S systems with CD12 SubBass cabinets, so they may be flown together, without causing any interference between the GEO S and CD12 wavefronts.

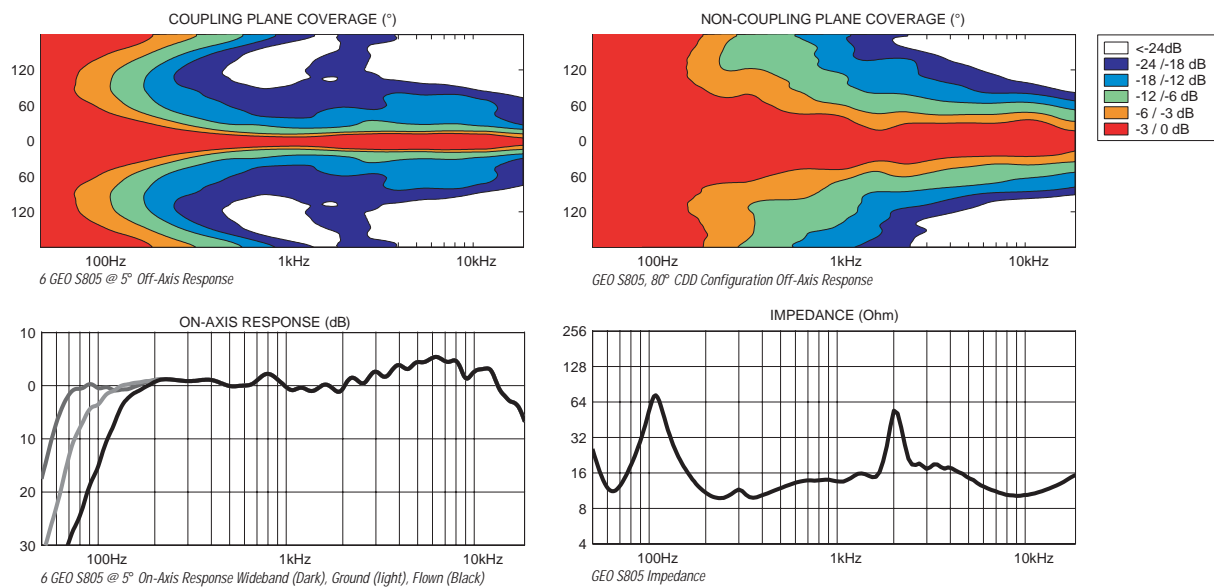

www.nexo-sa.com

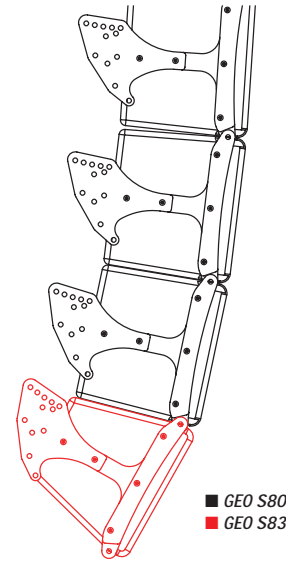

■ GEO S805  
■ GEO S830

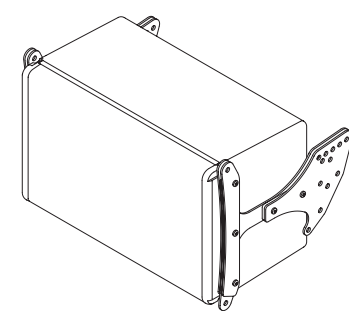
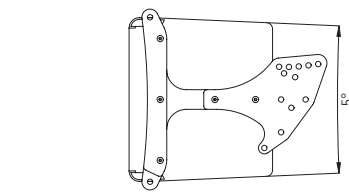
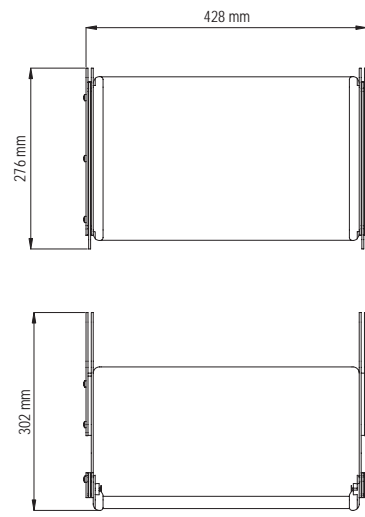

**GEO S805 PRODUCT FEATURES**

Components	LF 1x 8" (20cm) Neodymium Hi-Flux 16Ω Driver HF: 1x 1" Throat Neodymium Driver on a Hyperboloid Reflective Wavesource
Height x Width x Depth	428 x 276 x 303mm (16 7/8" x 10 7/8" x 11 7/8")
Shape	5° Trapezoid
Weight	13kg (28.6lbs) net
Connectors	2x NL4MP 4-pole SPEAKON (In & Through)
Construction	Baltic Birch Ply finish with structured black coating. Dark grey carpet is optional.
Fittings	Grill Perforated Steel
Flying	Integral flying system. Intercabinet Angle Adjustments = .31° to 5° (logarithmic steps).

**SYSTEM SPECIFICATIONS GEO S805 with NX242 TDcontroller**

Frequency Response [a]	67Hz – 19kHz ± 3dB
Usable Range @ -6dB [a]	60Hz – 20kHz
Sensitivity 1W @ 1m [b]	99dB SPL Nominal -97dB SPL Wideband
Peak SPL @ 1m [b]	Configuration dependent [d].
Dispersion [c]	Coupling Plane: Not usable as a single cabinet. Configuration dependent [d].
Non-Coupling Plane	120° (configurable to 80°).
Crossover Frequency	1.6kHz Passive
Nominal Impedance	16Ω
Recommended Amplifiers	1500 to 3000Watts into 4Ω / 4x cabinets per channel. Up to 6x cabinets per channel may be connected to large amplifiers capable of operating into low impedance loads.

**SYSTEM OPERATION**

Electronic Controller	The NX242 Digital TDcontroller presets are precisely matched to the GEO S8 Series cabinets and include sophisticated protection systems. Using GEO S8 Series cabinets without a properly-connected NX242 Digital TDcontroller will result in poor sound quality and can damage components. The GEO S805 & S830 can be used without the optional CD12 Hypercardioid Sub. In this case the NX242 can be used in stereo. With the CD12 Hypercardioid Sub, each Sub channel requires two NX242 outputs and the NX242 will operate in mono.
HF Dispersion Configuration	After release of the front grill from its fittings, the HF Waveguide can be configured for 80° or 120° dispersion in the non-coupling plane.
Array Design	S805 and S830 cabinets, having tangent waveguides, can be mixed in the same array. Minimum configuration or Vertical Tangent Arrays is 5x S805 & 1x S830 (4x S805 for paging applications only). CD12s are optional. A ratio of 1x CD12 per 3x full-range GEO modules is required for proper subbass output.
Speaker Cables	The GEO S805 and S830 are wired 1- & 1+ on both Speakon connectors, 2- & 2+ are not connected.
Rigging System	Please refer to the GEO User Manual before any operation.

**SHIPPING & ORDERING**

Packaging	S805s are packaged in pairs.
Shipping Weight & Volume	2x S805s: 29.2kg (64.2 lbs) 0.135 cu m (4.8 cu ft)

As part of a policy of continual improvement, NEXO reserves the right to change specifications without notice. [a] Response Curves and Data: Anechoic Far Field above 300Hz, Half-space below 300Hz. Usable Range Data: Frequency Response Capability with TD crossover slopes removed. [b] Sensitivity & Peak SPL: will depend on spectral distribution. Measured with band limited Pink Noise. Refers to the specified +/- 3dB range. Data are for Speaker + Processor + recommended amplifier combinations. [c] Directivity Curves and Data: 1/3 octave smoothed frequency response, normalized to On-Axis response. Data obtained by computer processing of off-axis response curves. [d] Please refer to the GEO User Manual.

**ARCHITECT'S AND ENGINEERING SPECIFICATIONS**

The 2-way full-range tangent array module shall have one 8" long-excursion neodymium hi-flux cone transducer and a 1" neodymium compression driver on a hyperboloid reflective wavesource. The system's coverage shall be configuration-dependent in the coupling plane. In the non-coupling plane it shall be 80°, configurable to 120° with user-removable flanges. The system's Directivity Index shall be configuration-dependent. Nominal Sensitivity shall be 99dB (97dB wideband). When driven by a NEXO NX242 Digital TDcontroller properly connected to amplification capable of delivering 1500 to 3000Watts into a 4Ω (nominal) load (4x cabinets per amplifier channel in parallel), the system shall be capable of 125dB to 128dB peak SPL (for a single enclosure: configuration-dependent when arrayed), with a frequency response of 67Hz to 19kHz ±3dB (60Hz to 20kHz ±6dB). The system shall include an internal passive crossover. Electrical connections shall be made via two 4-pole NL4MP SPEAKON connectors. The system shall have a tuned, ported 5° trapezoidal enclosure constructed of 18ply Baltic birch, finished in structured black coating. With flying hardware the system shall weigh 13kg(28.6lbs) and have exterior dimensions no greater than 428mmH x 276mmW x 302mmD (16 7/8" x 10 7/8" x 11 7/8"). Exterior hardware shall include an integral array assembly system with logarithmic steps and 0.01° precision. Interior components shall be protected by a powder-coated perforated steel grille. The system shall be the NEXO GEO S805 with a NEXO NX242 Digital TDcontroller. Other integrated loudspeaker/controller systems shall be acceptable, provided independent laboratory test results verify these specifications are equalled or exceeded.



S830 Rear view

S830 Front view with grill

### GEO S830

The compact GEO S830 is a high-output array module intended for horizontal tangent arrays or as a downfill element in curved (tangent) vertical arrays to establish consistent SPL in all coverage areas. The HRW™ allows the 30° S830 and 5° S805 to be coherently arrayed together.

GEO S Series loudspeakers ship with 120° dispersion (in the non-coupling plane) Configurable Directivity Devices (CDD), but are field-changeable to 80° CDDs. To maximize down-fill coverage, CDFs are used on GEO S830s for the bottom two rows of curved vertical arrays.

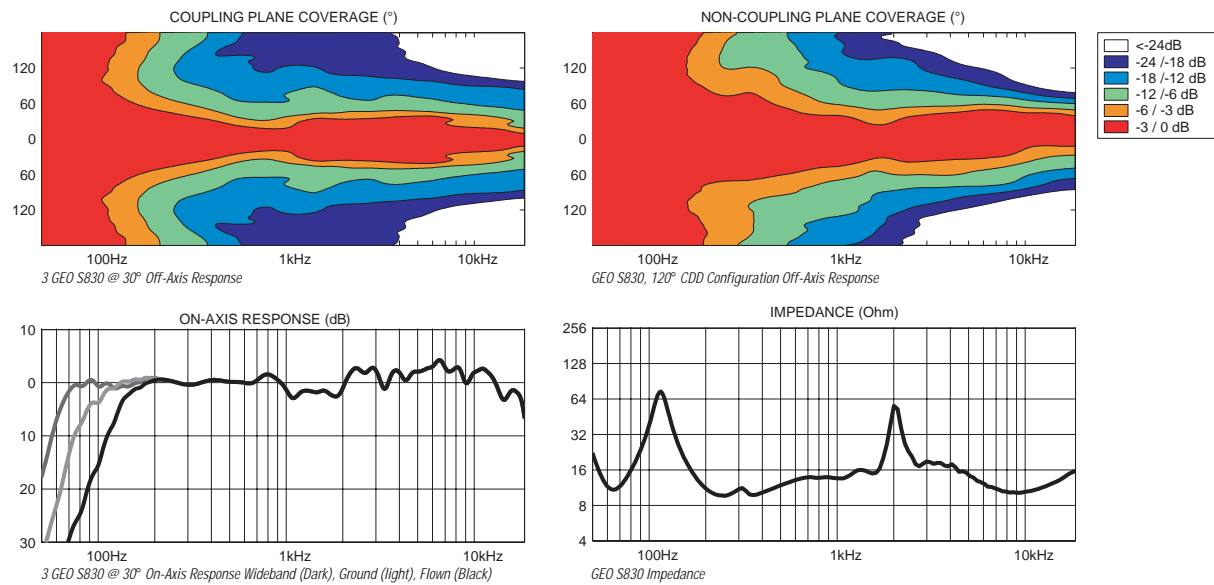

www.nexo-sa.com

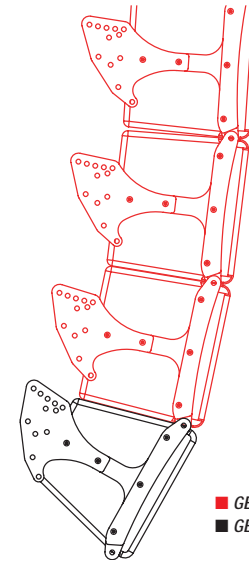

■ GEO S805  
■ GEO S830

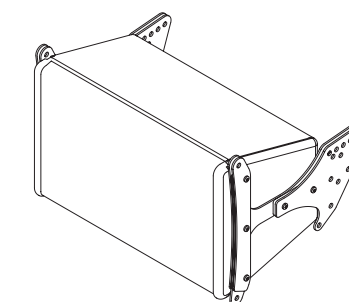
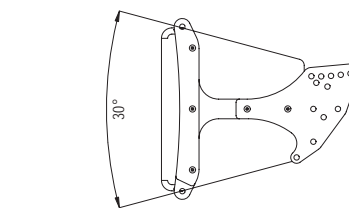
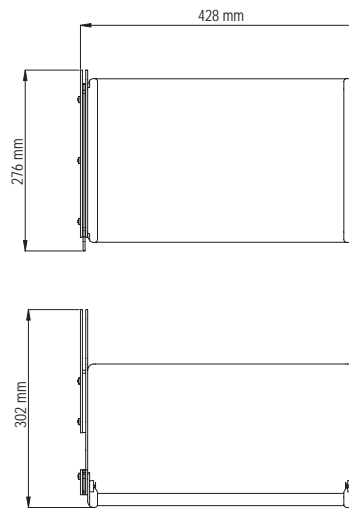

### GEO S830 PRODUCT FEATURES

Components	LF 1x 8" (20cm) Neodymium Hi-Flux 16Ω Driver HF: 1x 1" Throat Neodymium Driver on a Hyperboloid Reflective Wavesource
Height x Width x Depth	406 x 250 x 219mm (16" x 9 7/8" x 5 5/8")
Shape	30° Trapezoid
Weight	13kg (28.6lbs) net
Connectors	2x NL4MP 4-pole SPEAKON (In & Through)
Construction	Baltic Birch Ply finish with structured black coating. Dark grey carpet is optional.
Fittings	Grill Perforated Steel
Flying	Integral flying system. Intercabinet Angle Adjustments = 17.5° & 30°

### SYSTEM SPECIFICATIONS GEO S830 with NX242 TDcontroller

Frequency Response [a]	67Hz – 19kHz ± 3dB
Usable Range @ -6dB [a]	60Hz – 20kHz
Sensitivity 1W @ 1m [b]	99dB SPL Nominal -97dB SPL Wideband
Peak SPL @ 1m [b]	Configuration dependent [d].
Dispersion [c]	Configuration dependent [d].
Non Coupling Plane	120° (configurable to 80°).
Directivity Index [c]	Not usable as a single cabinet. Configuration dependent [d].
Crossover Frequency	1.6kHz Passive
Nominal Impedance	16Ω
Recommended Amplifiers	1500 to 3000Watts into 4Ω / 4x cabinets per channel. Up to 6x cabinets per channel may be connected to large amplifiers capable of operating into low impedance loads.

### SYSTEM OPERATION

Electronic Controller	The NX242 Digital TDcontroller presets are precisely matched to the GEO S8 Series cabinets and include sophisticated protection systems. Using GEO S8 Series cabinets without a properly-connected NX242 Digital TDcontroller will result in poor sound quality and can damage components. The GEO S805 & S830 can be used without the optional CD12 Hypercardioid Sub. In this case the NX242 can be used in stereo. With the CD12 Hypercardioid Sub, each Sub channel requires two NX242 outputs and the NX242 will operate in mono.
HF Dispersion Configuration	After release of the front grill from its fittings, the HF Waveguide can be configured for 80° or 120° dispersion in the non-coupling plane.
Array Design	S805 and S830 cabinets, having tangent waveguides, can be mixed in the same array. Minimum configuration for Vertical Tangent Arrays is 5x S805 & 1x S830 (4x S805 for paging applications only). CD12s are optional. A ratio of 1x CD12 per 3x full-range GEO modules is required for proper subbass output.
Speaker Cables	The GEO S805 and S830 are wired 1- & 1+ on both Speakon connectors, 2- & 2+ are not connected.
Rigging System	Please refer to the GEO User Manual before any operation.

### SHIPPING & ORDERING

Packaging	S830s are packaged in pairs.
Shipping Weight & Volume	2x S830s: 29.2kg (64.2 lbs) 0.135 cu m (4.8 cu ft)

As part of a policy of continual improvement, NEXO reserves the right to change specifications without notice. [a] Response Curves and Data: Anechoic Far Field above 300Hz, Half-space below 300Hz. Usable Range Data: Frequency Response Capability with TD crossover slopes removed. [b] Sensitivity & Peak SPL: will depend on spectral distribution. Measured with band limited Pink Noise. Refers to the specified +/- 3dB range. Data are for Speaker + Processor + recommended amplifier combinations. [c] Directivity Curves and Data: 1/3 octave smoothed frequency response, normalized to On-Axis response. Data obtained by computer processing of off-axis response curves. [d] Please refer to the GEO User Manual.

### ARCHITECT'S AND ENGINEERING SPECIFICATIONS

The 2-way full-range tangent array module shall have one 8" long-excursion neodymium hi-flux cone transducer and a 1" neodymium compression driver on a hyperboloid reflective wavesource. The system's coverage shall be 30° in the coupling plane. In the non-coupling plane it shall be 80°, configurable to 120° with user-removable flanges. The system's Directivity Index shall be configuration-dependent. Nominal Sensitivity shall be 99dB (97dB wideband). When driven by a NEXO NX242 Digital TDcontroller properly connected to amplification capable of delivering 1500 to 3000Watts into a 4Ω (nominal) load (4x cabinets per amplifier channel in parallel), the system shall be capable of 125dB to 128dB peak SPL (for a single enclosure: configuration-dependent when arrayed), with a frequency response of 67Hz to 19kHz ±3dB (60Hz to 20kHz ±6dB). The system shall include an internal passive crossover. Electrical connections shall be made via two 4-pole NL4MP SPEAKON connectors. The system shall have a tuned, ported 30° trapezoidal enclosure constructed of 18ply Baltic birch, finished in structured black coating. With flying hardware the system shall weigh 13kg(28.6lbs) and have exterior dimensions no greater than 406mmH x 250mmW x 219mmD (16 7/8" x 9 7/8" x 8 5/8"). Exterior hardware shall include an integral array assembly system with logarithmic steps and 0.01" precision. Interior components shall be protected by a powder-coated perforated steel grille. The system shall be the NEXO GEO S830 with a NEXO NX242 Digital TDcontroller. Other integrated loudspeaker/controller systems shall be acceptable, provided independent laboratory test results verify these specifications are equalled or exceeded.



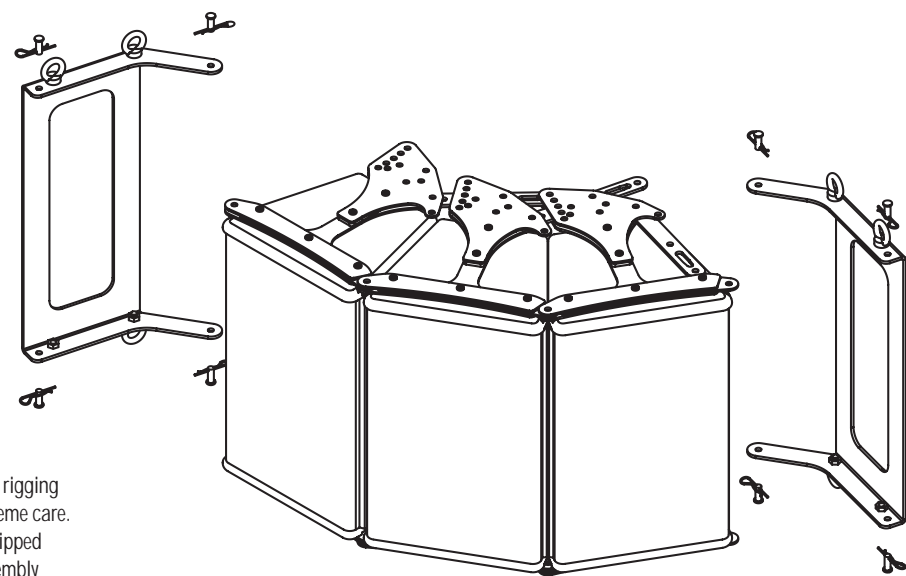

GEO S830s with hardware for horizontal rigging.

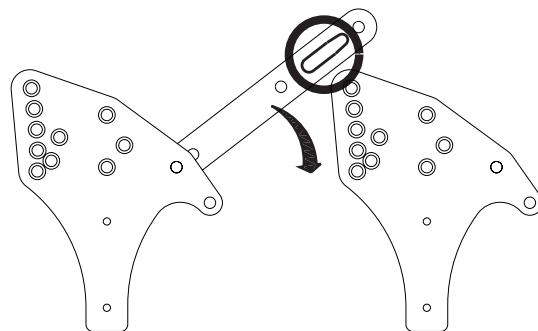

Angle-setting bar as used between two GEO S sideplates to adjust tangent array curvature.

**GEO S RIGGING**

The GEO S Array System is a professional rigging system, and should be handled with extreme care. GEO S850 and S830 loudspeakers are shipped from the factory with identical array assembly hardware. The GEO Array Assembly has three attachment points on each side (see Photo). The points in the front connect each GEO cabinet to the adjacent enclosures above and below.

The angle between cabinets is set by attaching one end of the angle-setting bar to the proper hole on the angle-setting plate which extends beyond the rear of the cabinet. The GEO S Bumper is symmetrical, enabling you to use GEO loudspeakers in a left/right stereo configuration. The connection between the top GEO S enclosure and the bumper determines the left/right orientation for the entire array.



GEO S Sideplates are identical on both S805 and S830 models.

We wish this brochure were large enough to explain every option of GEO S and GEO T system versatility. Unfortunately it isn't, so we ask you to remember that the following description of GEO S830 horizontal array deployment also applies to GEO T2815 design criteria, except of course with different coverage angles.

**GEO ARRAY & DEPLOYMENT FACTS**

- Horizontal arrays are the best solution for very wide coverage angles, such as stadium bowls, arena "exploded clusters" and multiple balcony, opera-style theatres centre-coverage in L-R-C designs.
- Because the patented GEO HTW employs an hyperboloid acoustic mirror rather than side walls to control dispersion, multiple sources can share a common point of origin.
- Because acoustic centers are in perfect alignment, GEO arrays do not display the interference and lack of coherency that is observed in conventional horn arrays.
- In the non-coupling plane (the vertical or horizontal arrays) GEO wavesources use a diffraction slot. Field-installable flanges can thus widen the vertical dispersion and produce asymmetrical patterns.

**GEO S TECHNOLOGY IN HORIZONTAL ARRAYS**

Do not think of GEO as only a vertical array system. Horizontal arrays of GEO loudspeakers have relatively high power (because of the narrow 30° horizontal array element) and wide front to back coverage of 80° to 120°. Horizontal arrays deliver equal power to equal angles, with SPL decreasing as you move further back in the audience. Because they are limited to a single row (for a coherent wavefront without interference in the vertical plane), horizontal arrays deliver "equal power to equal angles" and suited for a special set of audience geometries such as stadium bowls, arena "exploded clusters", opera-style theatres with multiple balcony levels and often as the centre cluster in a L-C-R system. Horizontal arrays of GEO S830 cabinets provide exceptional control of horizontal

coverage and, where the geometry is suitable, either GEO S or GEO T horizontal arrays will deliver a coherent wavefront in the midrange and high frequencies.

GEO S830 allows users to provide 30° increments of horizontal coverage as needed. Where the geometry is suitable, GEO arrays will deliver a coherent wavefront consisting of 30° tangent arcs that is more intelligible and reveals more musical detail than the incoherent sound produced by arrays using multiple conventional horns, which must be separated in space and time.

The GEO S830 is designed to array tangentially with adjacent S830 cabinets to provide a much more coherent wave front from an array of multiple cabinets than conventional arrayable cabinets. Where the best fit to the geometry of the listening area is a single row of horizontally-arrayed speakers, GEO technology provides a coherent source of midrange and high frequency energy. This is because GEO wavesources produce a curved wavefront using hyperboloid acoustic mirrors instead of angled sidewalls.

As explained in GEO SCIENCE & SOLUTIONS on pg #4, a hyperboloid, a GEO wavesource exhibits dual sources: a real source and a virtual source. The GEO design process puts the virtual source behind the enclosure, and these virtual sources can be perfectly aligned.



**GEO SOFT 2**

**COLD HARD ELECTRO-ACOUSTIC FACTS**

Due to the complex interaction between multiple loudspeaker cabinets, it is simply impossible to design curved vertical arrays reliably without using computer processing to predict the optimum array structure for any real-world audience geometry.

Still, the required design logic is far more complex than looking at a section drawing of the venue, measuring the overall angle needed to cover the audience from the cluster location, and dividing by 5° to determine the required number of GEO T4804 or S805 cabinets.

**ENTER GEOSOFT 2.0**

Simply put, GEOsoft v2 is another component of NEXO's integrated systems technology and a design tool that advances maximizes GEO loudspeaker performance. More precisely, GEOsoft v2 is three-dimensional, powerful and highly predictive R&D simulation software that processes measured speaker data with complex mathematical algorithms. The results assist GEO Series loudspeaker array deployments in delivering uniform SPL throughout the width and depth of any venue.

T Series Array Assembly System (TSASS)-see pg#10) and S series array assembly hardware (see pg #16) are keyed to GEOsoft v2, so that v2 software users can design vertical GEO arrays and tailor each array's wavefront to match audience topology, providing equal power to equal areas.

GEOsoft v2 also precisely creates/predicts system pressure levels to determine the number of loudspeaker cabinets needed for the application, as well as mechanical constraints for safely flown systems, in agreement with Structural Analysis Reports (available in the Help section): dimensions, weight, gravity center position, forces, moments, working load and safety factor.

NOTE: While GEOsoft v2 is an elegant acoustic prediction tool, it provides no information regarding safe assembly. Safety issues regarding installation and handling are fully detailed in each GEO User Manual Safety Section. NEXO's Web Site ([www.nexo-sa.com](http://www.nexo-sa.com)) periodically provides GEOsoft upgrades.

Screen views of GEOsoft 2.0 Display

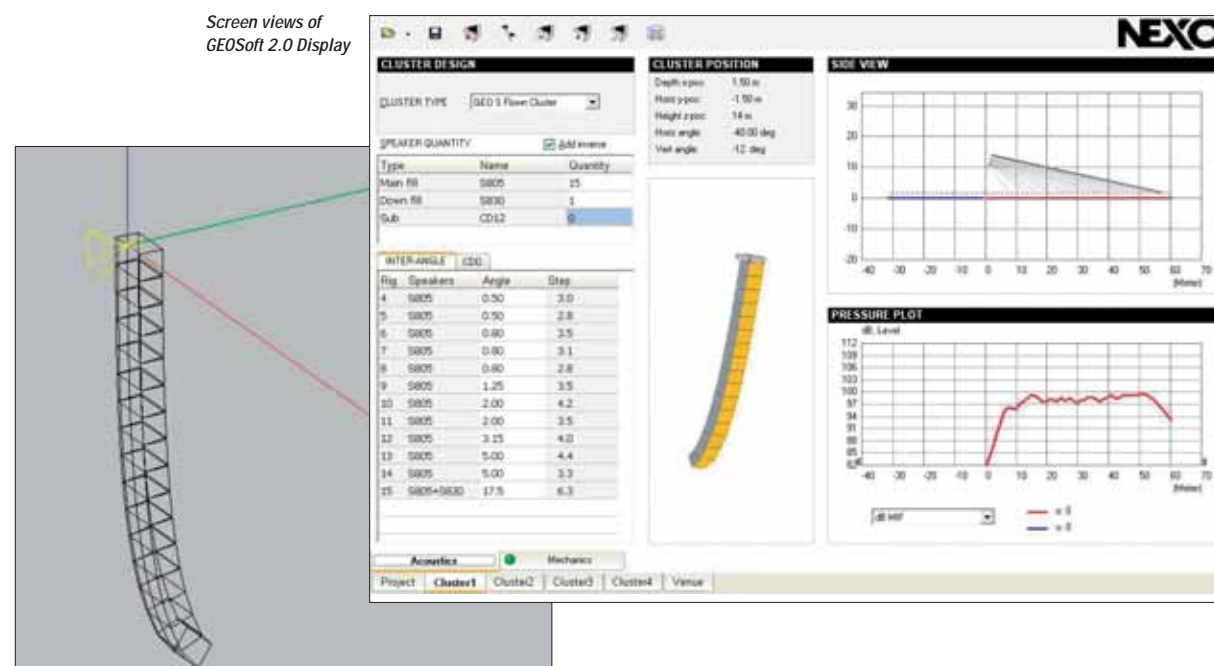





### CD18 SUB-BASS

Our CD18 SubBass has re-defined the art of VLF sound reinforcement in two significant ways. The sophisticated throat design profile is optimized to reduce unwanted "porting noise" at high SPL. More importantly, the CD18 applies "in reverse" microphone design techniques to produce a hyper-cardioid pattern from dual 18-inch horizontally-opposed woofers.

DSP algorithms, from NEXO's new generation NX242 TDcontroller are individually applied to both dual-ported woofers, to yield high-impact, forward sub-bass gain for audience members, and create more than +15dB rear attenuation. No other sub-bass system can better direct VLF energy away from open microphones and reverberant surfaces, especially the rear wall.



CD18 in carpeted cabinet



CD18 rear view



2x CD18 SubBass on factory-optional wheelboard

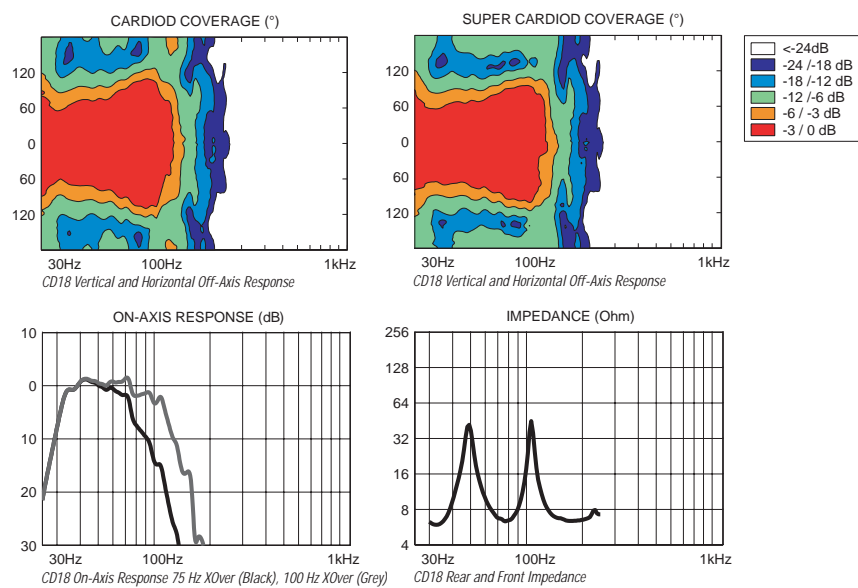
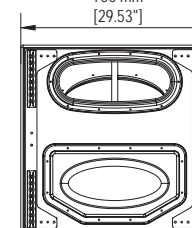
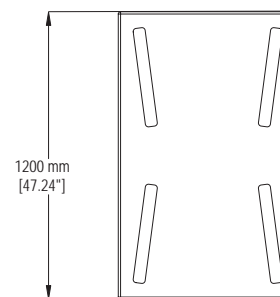
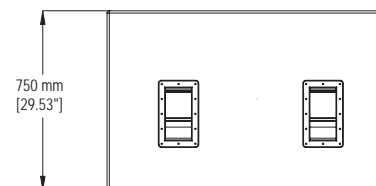
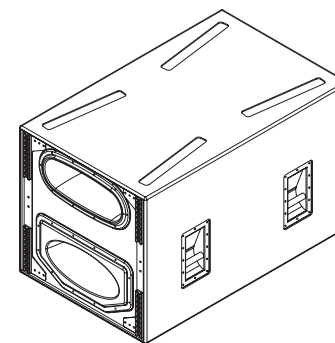

#### CD18 PRODUCT FEATURES

Components	2 x 18" (46cm) long-excursion neodymium 8 Ω drivers
Height x Width x Depth	750 x 1200 x 750mm (29 1/2" x 47 1/4" x 29 1/2")
Shape	Rectangular
Weight	116kg(255.7lbs) net
Connectors	2 x NL4MP 4-pole SPEAKON (In & Through)
Construction	Baltic birch ply finish with structured black coating. Dark grey carpet is optional.
Flying points	Integral flying system.

#### SYSTEM SPECIFICATIONS CD18 with NX242 TDcontroller

Frequency Response @ -3dB [a]	32Hz-100Hz ±3dB
Usable Range @ -6dB [a]	29Hz-120Hz
Sensitivity 1W @ 1m [b]	05dB SPL Nominal
Peak SPL @ 1m [b]	145dB Peak
Dispersion [c]	Cardioid or supercardioid pattern over the entire usable bandwidth depending on the NX242 Digital TDcontroller set up (two channels of the NX242 are used for the process).
Directivity Index [c]	Q=4.3   DI=6.3 dB and Q=5.3   DI=7.2 dB over the entire usable bandwidth for respectively cardioid and supercardioid mode.
Crossover Frequency	75 or 100Hz active through NX242 Digital TDcontroller.
Nominal Impedance	2x 8Ω
Recommended Amplifiers	2x amplifier channels are required for cardioid operation, each rated at 1500 to 3000Watts into 4Ω per channel. Up to 2x complete CD18s per channel may be connected to a two-channel amplifier.

#### SYSTEM OPERATION

Electronic Controller	The NX242 Digital TDcontroller presets are precisely matched to the CD18 and include sophisticated protection systems. Using CD18 SubBass without a properly-connected NX242 Digital TDcontroller will result in poor sound quality and can damage components.
Speaker Cables	The front loudspeaker of the CD18 is wired 2+ & 2- while the rear loudspeaker is wired 1- & 1+. The CD18 must use separate cables to the main system.
Rigging System [d]	Please refer to the user manual before any operation.

#### SHIPPING & ORDERING

Packaging	CD18s are packaged individually. Order as CD18-C (finished in grey carpeting) or CD18-P (finished in black structured coating).
Shipping Weight & Volume	1x CD18 = 131.5 kg (289.8lbs), .98 cu m (34.4 cu ft)

As part of a policy of continual improvement, NEXO reserves the right to change specifications without notice. [a] Response curves and data: Half-space Anechoic below 200Hz. Usable range data: frequency response capability with TD crossover slopes removed. [b] Sensitivity & peak SPL: will depend on spectral distribution. Measured with band limited pink noise. Refers to the specified ±3dB range. Data are for speaker + processor + recommended amplifier combinations. [c] Directivity curves and data: 1/3 octave smoothed frequency response, normalized to on-axis response. Data obtained by computer processing of off-axis response curves. [d] Please refer to the user manual.

#### ARCHITECT'S AND ENGINEERING SPECIFICATIONS

The subbass loudspeaker system shall have two 18" long-excursion 8Ω cone transducers. The system's horizontal and vertical coverage shall both range from 110° (supercardioid) to 120° (cardioid). The system shall have a Q of 5.3 (supercardioid) and 4.3 (cardioid), with a Directivity Index that is 7.2 (supercardioid) and 6.3 (cardioid). Nominal Sensitivity shall be 105dB. When driven by a NEXO NX242 Digital TDcontroller properly connected to amplification capable of delivering 1500 to 3000Watts into an 2x 8Ω (nominal) load (two channels required for directional control), the system shall be capable of 142dB to 145dB peak SPL, with a frequency response of 32Hz to 100Hz ±3dB (29Hz to 120Hz ±6dB). The system shall include an active crossover with DSP algorithms for directional subbass control. Electrical connections shall be made via two 4-pole NL4MP SPEAKON connectors. The system shall weigh 116kg(255.7lbs) and have an 18ply Baltic birch tuned dual-ported rectangular enclosure, with low speed port geometry, finished in structured black coating or dark grey carpeting and having exterior dimensions no greater than 750mmH x 1200mmW x 750mmD (29.5" x 47.2" x 29.5"). Exterior hardware shall include 2x flytracks front and rear, 4x top-mounted flytracks and 4x handles. The system shall be the NEXO CD18 SubBass with a NEXO NX242 Digital TDcontroller. Other integrated loudspeaker/controller systems shall be acceptable, provided independent laboratory test results verify these specifications are equalled or exceeded.





### CD12 SUB-BASS

The compact CD12 exhibits innovative control of long wavelength LF energy. The CD12 applies microphone design techniques "in reverse" to produce a hyper-cardioid pattern from twin 12-inch horizontally-opposed woofers. Sophisticated DSP algorithms, from the NX242 TDcontroller are applied individually to both dual-ported woofers, to produce high-impact forward gain, and +12dB rear attenuation. This means CD12 directs subbass energy towards the audience, and away from open microphones and reverberant surfaces, especially the rear wall.



CD12 rear view



CD12 front view

The CD12 is a hypercardioid subwoofer providing directional low-frequency output with dramatic LF reduction behind the cabinet(s). This is achieved by using the interaction of two independently-driven 12-inch drivers, highly specialised ports, and DSP control of the NX242TDcontroller.

**To maximize CD12 performance:**

- Maintain at least one meter(3ft+) of free space around ground-stacked CD12(s). Objects or barriers within this space may interfere with controlled wavefront interaction.
- Drive the front and rear drivers with identical amplifier channels set to the same gain. CD12

operation is based on the assumption that front and rear sub-systems are identical in terms of the amplifier's electrical performance.

- When flying the CD12(s), use the linking bar to connect the CD12 bumper to the GEO Bumper and keep at least 50cm(20in) of space between the back of the GEO cabinets and the front of the CD12(s). It provides enough distance so that the GEO cabinets will not interfere with the CD12 wavefronts.

- When hanging or stacking multiple CD12 cabinets, confirm that they are oriented correctly with fronts forward and tops up. Do not hang one CD12 upside down relative to the others.

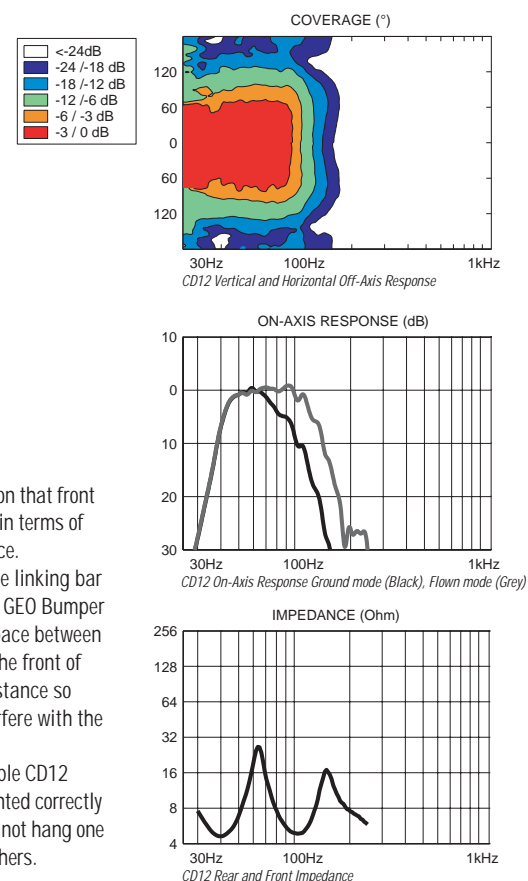

2x CD12s flying with 5x GEO S805s and a GEO S830

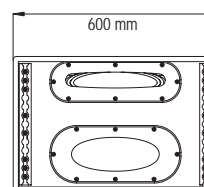
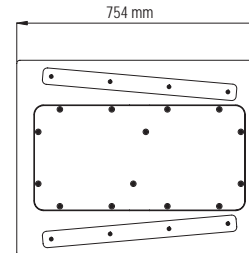
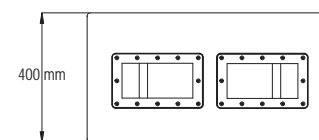
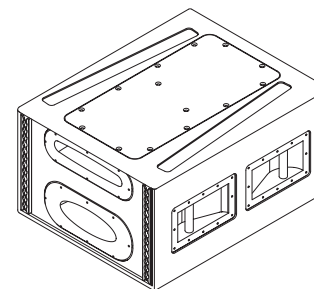

#### CD12 PRODUCT FEATURES

Components	2x 12" (30cm) Long-excursion Neodymium 6Ω Driver
Height x Width x Depth	400 x 600 x 754mm (15 3/4" x 23 5/8" x 29 11/16")
Shape	Rectangular
Weight	35kg(78.4lbs) net
Connectors	2x NL4MP 4-pole SPEAKON (In & Through)
Construction	Baltic Birch Ply finish with structured black coating. Dark grey carpet is optional.
Flying points	Integral flying system.

#### SYSTEM SPECIFICATIONS CD12 with NX242 TDcontroller

Frequency Response [a]	42Hz – 130Hz ±3dB
Usable Range @-6dB [a]	39Hz – 150Hz
Sensitivity 1W @ 1m [b]	102dB SPL Nominal
Peak SPL @ 1m [b]	131 to 134dB Peak (500 to 1200W RMS Amp)
Dispersion [c]	Hypercardioid pattern 120° x 120° over the entire usable bandwidth.
Directivity	Control is achieved through DSP algorithms in the NX242 Digital TDcontroller (two channels of the NX242 are used for the process).
Directivity Index [c]	Q = 3.773DI = 5.7dB over the entire usable bandwidth.
Crossover Frequency	90 or 130Hz Active through NX242 Digital TDcontroller
Nominal Impedance	2x 6Ω
Recommended Amplifiers	2x amplifier channels are required for Hypercardioid operation, each rated at 1500 to 3000Watts into 4Ω per channel. Up to 2x complete CD12s per channel may be connected to a two-channel amplifier.

#### SYSTEM OPERATION

Electronic Controller	The NX242 Digital TDcontroller presets are precisely matched to the GEO S8 Series cabinets and include sophisticated protection systems. Using GEO S8 Series cabinets without a properly-connected NX242 Digital TDcontroller will result in poor sound quality and can damage components.
Subbass	GEO S805 & S830 can be used without the optional CD12 Hypercardioid Sub. In this case the NX242 can be used in stereo. With the CD12 Hypercardioid Sub, each Sub channel requires two NX242 outputs, and the NX242 will operate in mono.
Speaker Cables	The front loudspeaker of the CD12 is wired 2+ & 2- while the rear loudspeaker is wired 1- & 1+. The CD12 must use separate cables to the GEO S805/S830.
Rigging System	Please refer to the GEO User Manual before any operation.

#### SHIPPING & ORDERING

Packaging	CD12s are packaged individually. Minimum configuration for GEO Vertical Tangent Arrays is 5x S805 & 1x S830 (4x S805 for paging applications only). CD12s are optional: but a ratio of 1x CD12 per 3x full-range GEO modules is required for proper subbass output.
Shipping Weight & Volume	1x CD12 = 42.35kg(93.4 lbs), 0.29cu m (10.2cu ft)

As part of a policy of continual improvement, NEXO reserves the right to change specifications without notice. [a] Response Curves and Data: Half-space Anechoic below 200Hz. Usable Range Data: Frequency Response Capability with TD crossover slopes removed. [b] Sensitivity & Peak SPL: will depend on spectral distribution. Measured with band limited Pink Noise. Refers to the specified +/- 3dB range. Data are for Speaker + Processor + recommended amplifier combinations. [c] Directivity Curves and Data: 1/3 octave smoothed frequency response, normalized to On-axis response. Data obtained by computer processing of off-axis response curves. [d] Please refer to the GEO User Manual.

#### ARCHITECT'S AND ENGINEERING SPECIFICATIONS

The subbass loudspeaker system shall have 2x 12" long-excursion 6Ω cone transducers. The system's horizontal and vertical coverage shall both be 120°. The system shall have a Q of 3.73 and a Directivity Index that is 5.7. Nominal Sensitivity shall be 102dB. When driven by a NEXO NX242 Digital TDcontroller properly connected to amplification capable of delivering 1800 to 2400Watts into an 2x 6Ω (nominal) load (two channels required for directional control), the system shall be capable of 131dB to 134dB peak SPL, with a frequency response of 42Hz to 130Hz ±3dB (39Hz to 150Hz ±6dB). The system shall include an active crossover with DSP algorithms for directional control of subbass. Electrical connections shall be made via two 4-pole NL4MP SPEAKON connectors. The system shall weigh 35kg(78.4lbs) and have an 18ply Baltic birch tuned dual-ported rectangular enclosure, with low speed port geometry, finished in structured black coating or dark grey carpeting and having exterior dimensions no greater than 400mmH x 600mmW x 754mmD (15.7" x 23.6" x 29.7"). Exterior hardware shall include 2x front-mounted flytracks, 2x rear-mounted flytracks and 4x handles. The system shall be the NEXO GEO CD12 SubBass with a NEXO NX242 Digital TDcontroller. Other integrated loudspeaker/controller systems shall be acceptable, provided independent laboratory test results verify these specifications are equalled or exceeded.



# DIGITAL NX242 TD CONTROLLER



Ether  
**ES**  
Sound

NEXO's new NX242 Digital TDController is an advanced, proprietary digital processor that maintains exceptional performance and reliability in GEO, Alpha and PS loudspeaker systems and associated Sub-basses. The NX242 provides crossover, sensed-amplifier control and system alignment acoustically matched to each NEXO component. The NX242's complex software algorithms integrate this calibrated data with sensed-voltage measurements, while analogue I/O functions share rear panel space with digital Audio Distribution and System Control over Standard Ethernet via EtherSound™ connection using the NXtension-ES4 Expander Board.

### MUCH MORE THAN EXPECTED

The NX242 offers every conceivable "generic" Digital Loudspeaker Controller function, but its real value is precision interface with NEXO loudspeakers. For example, every NX242 channel offers discrete simulation/protection processing and contains a combination of controlled gain stages (think of analogue VCAs), embedded into adaptive, complex composite signal chains with frequency-selective attenuation, similar to an analogue voltage controlled dynamic equaliser (VCEQ).

Each VCEQ and VCA is controlled, via synthesis of several signals, with multiple detection sections. That synthesis is the envelope of those signals, with optimised release and attack times for each VCEQ and VCA (depending on cabinet and frequency range).

NX242 also employs low and high-pass filters to filter potentially performance-degrading frequencies and maximize overall system response. High-pass filters also help prevent loudspeaker over-excitation at very low frequencies. Crossover function is tuned for every possible cabinet set-up and designed to optimize phase alignment throughout the crossover overlap

www.nexo-sa.com

region. Each crossover is customized so that each transducer will fit with its neighbour by achieving a perfect phase alignment. Unconventional, crossover-defined filters are applied, ranging from 6dB/octave to near infinite slopes.

### EQ, TIMING & SENSE

Time alignment is also unconventionally achieved, by combining crossover filter group delays with all-pass and/or frequency dependent delays. Active attenuation allows lowering of amplifier voltages for a given output SPL to maximum potential SPL. Active equalisation also extends a NEXO loudspeaker's frequency response, especially at LF, where output is cabinet size-limited.

The Sense-Input signal is routed to a shaping filter, producing a signal whose instantaneous amplitude is proportional to voice coil excursion. After rectification, this signal is compared to a preset threshold matching the maximum usable value, as determined from laboratory measurements. Any signal exceeding this threshold is sent to the VCEQ control buffer, while the VCEQ instantaneously acts as an excursion limiter.

To avoid detrimental effects caused by very long release time constants inherent to any temperature detection signal (i.e system output being reduced for an extended period, "pumping" effects, etc.), the detection signal is modulated by another voltage integrated with faster time constants that match subjective "human" sound perception. This allows the NX242 to reduce temperature limiter operating durations to natural levels, while keeping protection thresholds as high as possible.

### PHYSIOLOGIC DYNAMIC CONTROL

The NX242's unique Physiologic Dynamic Control (PDC) avoids unwanted effects from long attack time constants. Through anticipation of the temperature limiter, it prevents quick, high-level transient signals from triggering the temperature limiter. The PDC control voltage independently applies a low compression ratio to

the VCA, with its operation threshold slightly (3dB) above the temperature limiter.

An optimised attack time constant allows operation without any subjectively unpleasant transient effects, while the user-adjusted Peak Limiter threshold is set to match the amplifier's clip point, avoiding any audible artifacts and loudspeaker damage caused by intense amplifier distortion, thus protecting against driver overheating and over-excitation.

### ETHERSOUND™ INSIDE

EtherSound enhances NX242 functionality with easy-to-implement, high-quality audio networks utilising the NXtension-ES4. The patented EtherSound protocol provides full control with very low-latency (125µs, plus 1.6µs per additional network node) transmission of synchronized audio channels, over standard Ethernet. EtherSound's cost effective, all digital path, between a nearly infinite numbers of networked audio devices, offers up to 64 channels of 24-bit digital audio at 48KHz, plus bi-directional status and control data. Off-the-shelf Ethernet components, such as 100baseTX switches can extend the number of audio devices, as well as the distance between network devices.

### NXTENSION-ES4 EXPANDER BOARD

Central to the enhanced NX242's enhanced processing and network functions, the NXtension-ES4 Expander Board adds Digital Inputs/Output plus remote control functions via the DIGIGRAM EtherSound Network. The NX242's NEXO NXBoard-EtherSound interface provides four digital inputs and outputs, plus digital audio distribution over Ethernet with negligible propagation delay, allowing use in the most demanding live audio applications. Through an additional DSP chip and Flash memory, the NXtension Expander Board doubles NEXO NX242 memory capacity, compared to NX241 performance. In addition to digital input/output, the NXtension-ES4 provides full networking, or local remote control management, of channel

assignment and remote NX242 parameter control. The NXtension-ES4 also enables network remote installation survey, thanks to its native integrated networked status report capability.

### NXTENSION-CAI EXPANDER BOARD

The NXtension-CAI Expander Board further enhances NX242 processing capacities with remote control functions directed by CAMCO WINCAI protocol. NX-CAI's dual EtherCAI-WinCAI functions allow the NX242 to act as a bridge between the Ethernet and CAI networks. The EtherCAI-WinCAI interface provides full network or local remote control of all NX242 parameters including I/O meters and protection monitoring. Linked via Laptop, or through a standard Ethernet switch in star configuration, this protocol allows control of subsequent Vortex Amplifiers & NX242 Digital TDcontrollers daisy-chained through the CAI RS485 Network.

### NX242 FEATURES

- Precision circuits engineered for NEXO loudspeakers permit increased sound pressure and operational reliability.
- Flexible loudspeaker management for all NEXO loudspeaker systems, providing crossover, driver protection and system alignment.
- User-configurable inter-channel gain, delay and array EQ.
- Low and High-pass filters optimised to work in conjunction with overall system response.
- High-quality audio performance, 24bit data with 48bit accumulator; 100MIPS.
- 2x audio inputs, 4x audio outputs and 4 sense inputs enable a single NX242 to manage easily multiple NEXO cabinets across each product range.
- Comprehensive 16x2 character backlit LCD display, indicators and controls.
- Optional Remote Control, additional 100MIPS DSP and memory resources via the NXtension CAI expander board, based upon the CAMCO CAI protocol.
- Optional Remote Control, additional 100MIPS DSP and memory resources and link to the EtherSound Network (4in/4out) via the NXtension-ES4 expander Board.
- 4x NX242's processed (digital) audio outputs to 64x uncompressed channels of 24bit/48kHz of audio transmission over Ethernet.
- Updateable Flash EPROM (Firmware) Upgrades.
- Remote Control software is WIN2000/XP OS compliant.

### NX242 PRODUCT SPECIFICATIONS

Output Level	+28dBu Max into 600Ω.
Dynamic Range	All Channels = 110dB.
THD+N Output	Typ 0.005% @ 1000Hz @ 27dBu.
Latency Time	2.2ms flat set-up
Output Level	110-220 Volts, 50-60Hz continuous operation (Operating range 90-264V)
Audio Inputs	2x L&R Heavy Duty Audio inputs, 24bit converters; Electronically balanced and floating, 20kOhm. CMMR=80dB. 2x XLR 3 connectors.
Sense Inputs	4x Amplifier Sense-Inputs, 18bit converters; Floating 150kOhm. 8-Pole Removable Strip Terminal.
Audio Outputs	4x audio outputs, 24bit converters, Electronically balanced, 500hm. 3x XLR-3M connectors.
Processing	24bit data with 48bit accumulator. 100MIPS.
Front panel	Menu A and Menu B buttons. 16 x 2 character backlit LCD Display. Select Wheel and Enter Button; Four MUTE/SOLO Buttons.
Indicators	4x Speaker Protect yellow LEDs. 4x green Amp Sense LEDs. 4x red Peak LEDs. 4x red Mute LEDs; 2x red LEDs; Input CLIP and DSP CLIP.
Rear panel	On/Off Mains switch; mains IEC socket; RS232 serial communications connector; Expansion slot for processor extension card;
Flash/EPROM	Software upgrades and new cabinet set-ups are available from NEXO web site.
Dimensions	1RU (19in) Width, 230mm (9in) Depth
Weight	3.8kg(8.8lbs) net

### USER CONTROLS

System Selection	Allows control from all NEXO ranges.
System Set-up	Within the selected range, allows the cabinet to be set for passive or active mode, aux, mono or stereo subs, wedge or FOH operations depending on system selected. Up to 80x factory pre-sets.
Protection	Peak Limiter, Displacement and Temperature protection on every channel; Physio control of the Protection limiter & compressors Soft Clip Automatic tracking of amplifier clip point
Delay	Up to 150m (465 ft.) of delay in 10cm (.4in) steps; on Sub channel, Main channels or Sub + Main linked
Input Sensitivity	Level From 6dB to +12dB in 3dB steps.
Output Level	Global and inter-channel gain 6dB in 0.5dB steps.
Amplifier Gain Reading	Allows amplifier gain checking with program material.
Mute/Solo	Changes front panel buttons from Channel Mute to Solo
Save/Recall	Set-up Stores up to 10 user set-ups; On- the-fly recall, without mute or glitches for instant comparison.
Array EQ	LF or HF shelving filter to compensate ground or stacking effects, +/-6dB
Security Mode	Password protected in Read-Only Mode

### SHIPPING & ORDERING

Packaging	NX242s are sold as single items and multiples thereof.
Shipping Weight & Volume	1 x NX242 = 4kg(8.8lbs) 0.02 cu m (0.71 cu ft)

Complying with the safety objectives of 73/23/EEC & 89/336/EEC directives. (EN 60065-1998, EN55103-1996) CB scheme cULus certification in progress.

### ARCHITECT'S AND ENGINEER'S SPECIFICATIONS

The 1RU TDController shall be configurable from a combination of two inputs and four outputs with each output providing facilities for crossover, parametric EQ, mid-filter limiters, and delays for all the current NEXO ranges. The unit shall have electronically balanced analogue inputs and outputs. Each input must have facilities for automatic EQ, user configurable delays, Soft Clip Automatic tracking of amplifier clip point, plus LF or HF shelving filter to compensate ground or stacking effects, ±6dB. Any output may take its feed from any input, including a mono sum of the two inputs. MUTE (or solo) buttons and LEVEL TRIM controls for each output must be independent and directly accessible through front-panel switches. Data shall be numerically displayed on 16x2 character backlit LCD Display and controlled from Menu A and Menu B buttons or Wheel and Enter Button. Up to 80x factory pre-sets, within the selected range, shall allow cabinets to be configured for passive or active mode, aux, mono or stereo subs, wedge or FOH function. All crossover, protection parameters, and EQ are factory optimized and can't be modified by the user. Password protected: Read-Only Mode. The controller must model the loudspeakers in real time and this modelling shall include loudspeaker temperature and displacement. Protection algorithms shall be selective, acoustically transparent and not allow the loudspeaker to exceed speaker-dependent thresholds. The controller shall be able to apply DSP to the loudspeaker to achieve cabinet directivity control if needed. The controller shall have 4x inputs providing feedback from amplifier output to allow real time monitoring of amplifier gain and clipping voltage. The controller shall display an extension slot, allowing factory (or user)insertion a daughter board to increase memory and DSP resources and add remote function control. The controller shall be the NEXO NX242 TDController.

NX242