

MAINTENANCE AND OPERATION
INSTRUCTION MANUAL

DB44

Compact FM Radio Monitoring Receiver
and Basic Modulation Analyzer



Contents

Introduction	4
General Information	5
Product Features	6
<i>Technical Specifications</i>	7
<i>Block Diagram</i>	9
Factory Default Settings	10
<i>Network Settings</i>	10
<i>WEB Server</i>	10
<i>E-mail</i>	10
<i>Audio</i>	10
<i>GSM MODEM</i>	10
<i>SNMP Settings</i>	11
<i>Management Settings</i>	11
<i>Channel Presets Default Settings</i>	12
Safety Precautions	13
Panel Indicators and Appointments	14
<i>Front View</i>	14
<i>Rear View</i>	15
Getting Started	16
<i>Connection</i>	16
<i>Network Settings</i>	17
<i>Login</i>	18
Operation	19
<i>Tuner Screen</i>	19
<i>Main Screen</i>	20
<i>RDS Screen</i>	21
<i>ODA Screen</i>	22
<i>FM Graph Screen</i>	23
<i>MPX Screen</i>	24
<i>Spectrum Analyzer Screen</i>	25
<i>Scope Screen</i>	26
<i>Bandscan Screen</i>	27
<i>Status Screen</i>	28
<i>LOG Screen</i>	29
<i>Settings Screen</i>	30
<i>Main Settings Screen</i>	30
<i>Channel Settings Screen</i>	32
<i>Alarm Triggers Defined</i>	34
<i>Alarm Notifications</i>	36
<i>Management Screen</i>	37
<i>External GSM Modem Settings</i>	39
UPnP and DB44 discovery in Local Networks	41
UPnP Activation	42
WARRANTY TERMS AND CONDITIONS	43
Product Registration Card	44

THIS PAGE
IS INTENTIONALLY
LEFT BLANK

Introduction

DEVA Broadcast Ltd. was established in 1997 as a broadcasting and telecommunications equipment importer for Bulgaria and Eastern Europe regions. Subsequently, DEVA Broadcast Ltd. has developed and produced a wide range of low and mid power transmitters, RDS/RBDS Encoders and Decoders, Modulation Monitors, Remote Controls, Site monitoring and other systems for many companies. Our high degree engineers accomplish their bright ideas through successful engineering, marketing and management in DEVA Broadcast Ltd.'s Headquarter in Bulgaria.

During the last ten years the company products have become our partners' best sellers. After detailed marketing analysis, our team has decided to launch its own brand products based on the latest technologies in the broadcasting business. The company's main goal is to design, develop and offer a complete line of high quality and competitive products for FM and Digital Radio, Radio Networks, Telecommunication Operators and regulation authorities. We base our market authority position on our good after sales support and relation with the clients.

Since 2003 DEVA Broadcast Ltd. has been ISO 9001 certified .

The contractors of DEVA Broadcast Ltd. are satisfied with the permanent business comfort and to their own confession they owe it to a great extent as well as their prosperity to the loyal partnership of our company.

General Information

Compact, Robust, Reliable and Clever - This is just a small part of all the benefits of our DB44 FM Radio Monitoring Receiver and Basic Modulation Analyzer. Based on the latest technology, the DB44 core is DSP based digital design for 24/7/365 operation.

After demodulating the FM signal, the MPX signal is digitalized and all signal processing is then made through calculations. Digitizing in this way, at the input gives the equipment measurement reproducibility over time. Digital filters' accuracy, used in this equipment, enables the FM multiplex signal's components to be accurately and repeatedly reproduced from one device to another, i.e. same signal applied to two devices will give the same result. The processing power in this equipment enables all measurements to be refreshed simultaneously and synchronously, thereby allowing for detailed readings of all the Multiplex FM signal components.

DB44 allows you through its TCP/IP and GSM Connectivity to monitor all the RDS and some other signal parameters from anywhere. You can easily receive the channel status or listen to the audio from anywhere, using your mobile phone. With the built-in Audio Streamer you can even listen to, skim and record the audio from any station. DB44 is our most cost effective unit for permanent monitoring of the quality and continuity FM Radio Stations or Radio Networks.

Product Features

- Fully DSP based core
- Built-in Oscilloscope allowing Left, Right and MPX display
- MPX Power measurement with data history
- MPX Spectrum analyzer for Left, Right and MPX measurements
- Scope with Cloud Lissajous and Star Stereo Signal Representation
- Selectable De-emphasis – 50 μ s and 75 μ s
- Built-in Stereo Decoder; Stereo Presence Detection
- Date & Time Settings for manual or automatic synchronization
- LAN port for full TCP/IP remote control and monitoring
- SNMP remote monitoring and configuration
- Up to 90dB μ V direct RF Antenna Input
- Adjustable alarms for RF, Deviation, Audio, Pilot, RDS Signal and RGS Groups
- Firmware update for future-proof operation
- Parameters Factory Restore Option
- FM Band 87 - 108 MHz Basic Spectrum Analyzer
- MPX, PILOT & RDS deviation meters
- LEFT and RIGHT demodulated audio level meters
- Headphones audio output
- RDS and RBDS decoder with BER meter
- Alarm dispatch via E-mail, SMS, SNMP
- Channel status reporting via SMS
- RF and RDS Measurements
- Remote Listening via optional GSM modem
- Real Time Audio Program Streaming
- Dual level access - Administrator and User accounts
- Attractive price and very good price-performance ratio
- Very Intuitive Embedded WEB server for interactive supervision
- Proved and reliable hardware for 24/7/365 operating
- Easy Installation and Setup
- SNTP for automatic synchronization of the built-in clock
- Compact and Robust Aluminum Case for high RF immunity

TECHNICAL SPECIFICATIONS

RF INPUT	
Frequency Range	87.0 to 108.0 MHz, Frequency Agile
Step Increment	50 kHz
Antenna Input	50Ω, BNC Connector, 10 dBμV sensitivity
Internal Attenuator	0, 10, 20 and 30dB, auto
Dynamic Range	0 dBμV to 100 dBμV
S/N	57dB, RF > 60dBμV, 30dB, RF > 10dBμV
METERING RESOLUTION & ACCURACY	
RF Level	0 to 95 dBμV; resolution - 0.1 dBμV; accuracy - ±1 dB (10 to 85 dBμV)
Multipath	0 to 100%; accuracy - ±1%
MPX Deviation	±120 kHz; resolution - 0.1kHz; accuracy - ±10%, ±5% typically
MPX Power	±12 dBr; resolution - 0.1dBr, 10 sec. integration; accuracy - ±0.2 dBr
Audio Level	-50 to +5dB; resolution - 0.1dB; accuracy - ±5%
Pilot Level	0 to 12 kHz; resolution - 0.1 kHz; accuracy - ±0.5 kHz, 1 to 12 kHz
RDS Level	0 to 9 kHz; resolution - 0.1 kHz; accuracy - ±10% typical and not guaranteed
AUDIO, MPX, PILOT, RDS LEVELS	
Validity	RF level preferably > 50dBμV
Multiplex Level	Peak level, 256 ksamples over 1 sec.
Audio Level	Peak level, 64 ksamples over 1 sec.
Pilot Level	Mean peak level, 256 ksamples over 1 sec.
RDS Level	Mean peak level, 256 ksamples over 1 sec.
STEREO DECODER	
Stereo Separation	>25dB, typical >30dB
De-emphasis	50 or 75μs, Selectable
THD	0.5%
OUTPUTS	
Audio stream	Icecast/Shoutcast compatible audio stream
Alarms	SMS, E-mail, SNMP
Headphone	1/8" (3.5mm) Phone Jack
GSM Modem	15-pin Male D-Sub Connector

RDS DATA DECODING	
Standards	European RDS CENELEC; United States RBDS NRSC
Error Correction & Counting	Yes
AF Decoding	Yes
CT (Time/Date)	Yes
PI, PTY, DI, MS	Yes
TA/TP	Yes
RT (Radio Text)	Yes
PS (Program Service name)	Yes
PIN	Yes
RT+	Yes
TMC	Yes
FFT SPECTRUM ANALYSIS	
Input	Composite MPX, Audio
Dynamic Range	80 dB
FFT Length	1024
Sampling Rate	256 kHz - Composite, 64 kHz - Audio
SCOPE ANALYSIS	
Input	Composite MPX, Audio
Trigger Mode	Auto, Fall
Dynamic Range	±120 kHz
Sampling Rate	256 kHz - Composite, 64 kHz - Audio
USER INTERFACE	
Web interface	Full monitoring and control; Interactive and easy to use
Indicators	3 LEDs (on front panel)
Headphone Output	1/8" (3.5mm) phone jack (on front panel)
TCP/IP COMMUNICATION	
Type	Ethernet 10/100M Base-T Port
Connector	RJ45 (on rear panel)
OPERATING CONDITIONS	
Temperature	10° to 60°C
EMC Immunity	6V/m
POWER REQUIREMENTS	
Power Supply	External, 12V/1A
SIZE AND WEIGHT	
Dimensions (W x H x D)	(125 x 31 x 160mm), (5" x 1.2" x 6.3")
Shipping Weight	1,5 kg

BLOCK DIAGRAM

A simplified block diagram of DB44 is shown below

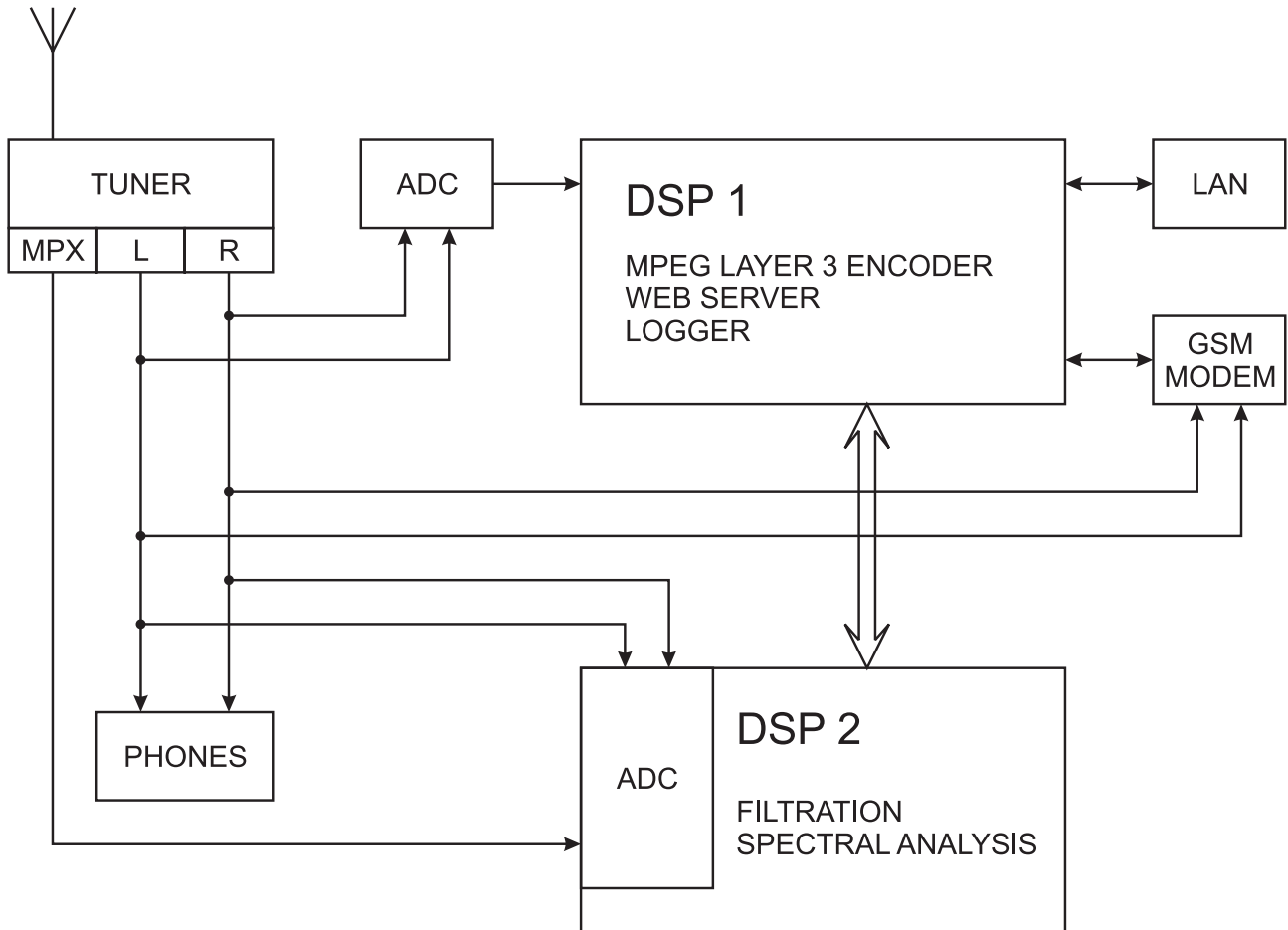

Because of the all-digital, minimalist-discrete-component nature of device circuitry, we have not provided schematic diagrams of the DB44 in this Manual. Please, note that:

**NO USER-SERVICEABLE COMPONENTS INSIDE.
 REFER ALL SERVICING TO
 QUALIFIED TECHNICAL PERSONNEL.**

Factory Default Settings

NETWORK SETTINGS

IP	192.168.1.2
Gateway	192.168.1.1
Subnet Mask	255.255.255.0
DNS	192.168.1.1
DHCP	Disabled

WEB SERVER

HTTP Port	80	
Admin	Username	user
	Password	pass
User	Username	user
	Password	pass

E-MAIL

E-mail 1	<i>blank</i>
E-mail 2	<i>blank</i>
Sender	<i>blank</i>
Server	<i>blank</i>
Port	25

AUDIO

Stream Port	5000
Name	DB44 - FM Radio Monitoring Tool
Quality	128 kbps

GSM MODEM

Number 1	<i>blank</i>
Number 2	<i>blank</i>
Number 3	<i>blank</i>
Number 4	<i>blank</i>
Baudrate	9600

SNMP SETTINGS

Agent	Enabled
Agent ID	1
Agent Port	161
Read Community	DEVA44
Write Community	DEVA44
Manager IP	192.168.1.1
Manager Port	162

MANAGEMENT SETTINGS

Attenuator	Auto
De-emphasis	50 μ s
Internet Time	Enabled
Internet Time Server	pool.ntp.org
Internet Time Server Port	123
Time Zone	UTC (+00:00)
Web session timeout	3 minutes
SNMP session timeout	1 minute

CHANNEL PRESETS DEFAULT SETTINGS

Parameter	CH 1	CH 2	CH 3	CH 4	CH 5	CH 6
Scheduling	Disabled	Disabled	Disabled	Disabled	Disabled	Disabled
Frequency	98 kHz	98 kHz	98 kHz	98 kHz	98 kHz	98 kHz
Alarms Control	All Disabled	All Disabled	All Disabled	All Disabled	All Disabled	All Disabled
Trigger Time	5 minutes	5 minutes	5 minutes	5 minutes	5 minutes	5 minutes
Release Time	5 minutes	5 minutes	5 minutes	5 minutes	5 minutes	5 minutes
RF Alarm Low Threshold	40 dB μ V	40 dB μ V	40 dB μ V	40 dB μ V	40 dB μ V	40 dB μ V
RF Alarm High Threshold	60 dB μ V	60 dB μ V	60 dB μ V	60 dB μ V	60 dB μ V	60 dB μ V
MPX Alarm Low Threshold	50 kHz	50 kHz	50 kHz	50 kHz	50 kHz	50 kHz
MPX Alarm High Threshold	90 kHz	90 kHz	90 kHz	90 kHz	90 kHz	90 kHz
MPX Power Alarm Low Threshold	-8 dBr	-8 dBr	-8 dBr	-8 dBr	-8 dBr	-8 dBr
MPX Power Alarm High Threshold	6 dBr	6 dBr	6 dBr	6 dBr	6 dBr	6 dBr
Left Alarm Low Threshold	-30 dB	-30 dB	-30 dB	-30 dB	-30 dB	-30 dB
Left Alarm High Threshold	3 dB	3 dB	3 dB	3 dB	3 dB	3 dB
Right Alarm Low Threshold	-30 dB	-30 dB	-30 dB	-30 dB	-30 dB	-30 dB
Right Alarm High Threshold	3 dB	3 dB	3 dB	3 dB	3 dB	3 dB
Pilot Alarm Low Threshold	5 kHz	5 kHz	5 kHz	5 kHz	5 kHz	5 kHz
Pilot Alarm High Threshold	9 kHz	9 kHz	9 kHz	9 kHz	9 kHz	9 kHz
RDS Alarm Low Threshold	2 kHz	2 kHz	2 kHz	2 kHz	2 kHz	2 kHz
RDS Alarm High Threshold	7 kHz	7 kHz	7 kHz	7 kHz	7 kHz	7 kHz
RDS Group Alarm	All Disabled	All Disabled	All Disabled	All Disabled	All Disabled	All Disabled

Safety Precautions

IMPORTANT: *Carefully read this paragraph as it contains important instructions concerning operator safety and directions regarding the installation, operation and maintenance of the equipment. Failure to observe the safety instructions and information given in this manual constitutes an infringement of the safety rules and design specifications provided for this piece of equipment. DEVA Broadcast Ltd. declines all responsibility if any one of the safety rules given herein is not observed. DEVA Broadcast Ltd. declines all responsibility if the end-user resells the product. The equipment is to be used by people capable of operating it in a trouble-free manner and it is assumed that they are aware of the following safety rules.*

- ◇ Keep this manual with the utmost care and close at hand so that it can be consulted whenever needed
- ◇ After unpacking the equipment, check its condition.
- ◇ Avoid banging the equipment.
- ◇ The packing material (plastic bags, polystyrene, nails, etc.) must never be left within reach of children, as these items are potential sources of danger.
- ◇ Do not use the equipment in places where the temperature is not within the recommended range, as specified by the manufacturer.
- ◇ Before connecting the equipment, make sure the nameplate specifications correspond to the mains electricity supply (the nameplate is located on the equipment enclosure).
- ◇ Do not remove the sticker from the equipment as it contains important specifications and the relevant serial number.
- ◇ To join the equipment to the mains supply, use the power cord purchased with the equipment.
- ◇ The equipment must be used only for the purposes it was designed for.
- ◇ Abuse or misuse of the equipment is extremely dangerous for people, pets and property. The manufacturer declines all responsibility for damage and injury resulting from improper use and mishandling.
- ◇ Certain basic safety rules must be observed when using electrical equipment, in particular:
 - Never touch the equipment with wet and/or damp hands or other parts of the body.
 - Keep the equipment away from drops of water or sprinkling systems.
 - Never use the equipment near high heat sources or explosive material.
 - Do not introduce any extraneous matter into the equipment.
 - Do not allow children or untrained people to use the equipment.
- ◇ Before cleaning or servicing the equipment outside, disconnect its power supply and wait at least 2 seconds before working on it, as recommended by current safety regulations.
- ◇ In the event of faults and/or improper operation, turn off the equipment, shut off the electrical power and call your dealer.
- ◇ Do not attempt to make repairs and/or adjustments when covers/guards or circuit boards are to be removed.
- ◇ Call your dealer for any repairs and be certain original spare parts are used. Failure to observe this rule may adversely affect the safety level of your equipment.
- ◇ The equipment is to be connected to the mains supply and provided with adequate and efficient earth conductors.
- ◇ When installing, leave a clearance of at least 1 cm around the equipment to allow air to pass freely.

Panel Indicators and Appointments

FRONT VIEW



- 1 - Phones Output - Audio signal from the tuned frequency.
- 2 - Power LED Indicator
- 3 - GSM LED Indicator. This LED can in one of the following states:
 - Off - no GSM Modem;
 - Fast Blinking – GSM Modem initialization;
 - Slow Blinking – GSM Modem present and operating;
- 4 - LAN LED Indicator. This LED can be in one of the following states:
 - Off - No User Connected, Logger is active;
 - Blinking – User is connected, Logger is inactive;

REAR VIEW

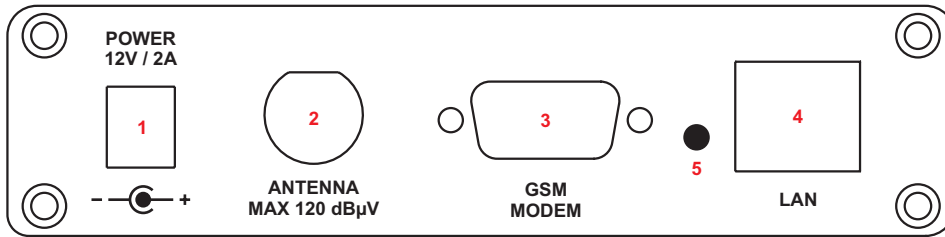

- 1 - Power Supply (12V, 2A);
- 2 - Antenna Input - BNC connector for FM Antenna;
- 3 - GSM Modem Connector - DB-15 male;
- 4 - LAN Port / Internet Input – standard RJ-45 port;
- 5 - Factory Defaults reset button

Getting Started

For the normal operation of DB44, you will need the following conditions:

- Standard Ethernet 10/100M connection;
- Correct assigned Network configuration and device settings;

To provide all these conditions please, follow the instructions below.

CONNECTION

- Install the unit on its operation place;
- Connect the unit to the power supply network using the power cable provided with the unit;
- Connect the antenna cable to the RF antenna input connector located on the rear panel of the device;
- Connect DB44 to the TCP/IP network using direct network cable;
- Connect the optional GSM modem via the connection cable provided with the GSM modem. Please, locate and select proper place of the GSM antenna for achieving better GSM network coverage.

NOTE: The GSM antenna must be far enough from the monitoring devices. The GSM modem radiate RF signal that may cause spurious emissions that will make troubles with the accuracy of the measurements.

NETWORK SETTINGS

After connecting the network cable the Led 'LAN' located on the rear panel must be ON or flashing. The next and most important step for configuration is the adjustment procedure of the Network Communication. The settings shown below are Default Network Settings:

IP : 192.168.1.2
Mask : 255.255.255.0
Gateway : 192.168.1.1
DNS : 192.168.1.1
DHCP : Disabled
HTTP Port : 80
Stream Port : 5000
SNMP Agent Port : 161
SNMP Manager IP : 192.168.1.1
SNMP Manager Port : 162

DB44 is controlled through the built-in web server and a standard web browser can be used to monitor its status or make some adjustments. To connect to the device you need to know its IP address and follow the next steps:

- Open a WEB Browser.
- Enter the device IP address in the browser's address field.

NOTE: If the port is different than the default one (80), it is necessary to specify it, e.g. http://192.168.1.2:9000

- Press <ENTER>.

If you do not know the IP address you can access DB44 by using UPnP discovery in local networks ([see "UPnP and DB44 discovery in Local Networks" on page 41](#)).

ATTENTION: Depending on Internet Protocol Settings, assigned IP address may not be visible outside your local network, thus device may be accessed only within that network. Consult with your network administrator for the appropriate IP settings.

LOGIN

ATTENTION: Upon Login the DB44 Logger will stop and will start again automatically after Logout.

DB44 serves only one user at a time, thus Username and Password will be requested when connecting. Default values are *user* and *pass*.

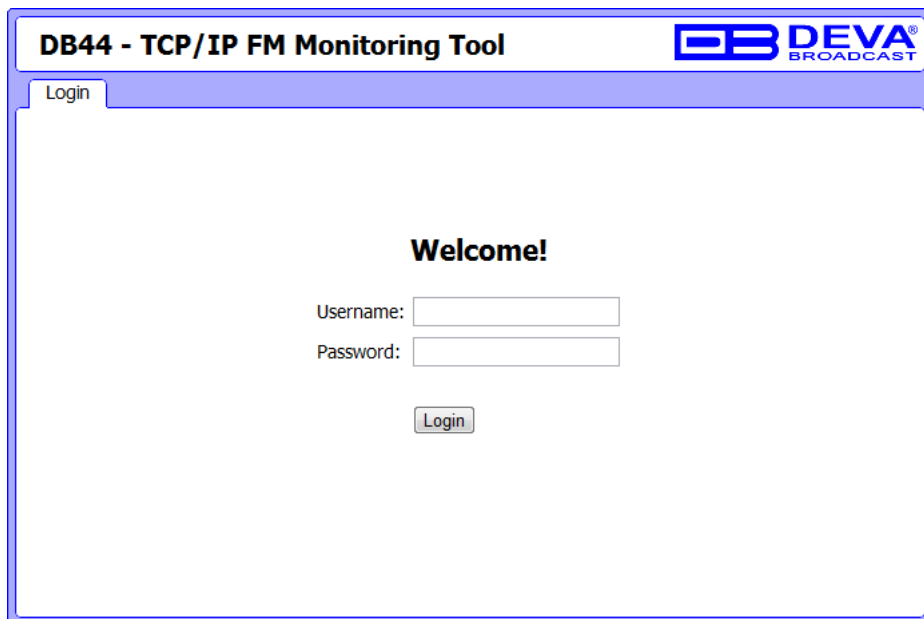

The screenshot shows the 'DB44 - TCP/IP FM Monitoring Tool' interface. At the top right is the DEVA BROADCAST logo. Below the title bar is a 'Login' tab. The main content area displays 'Welcome!' followed by two input fields: 'Username:' and 'Password:'. Below these fields is a 'Login' button.

Enter your credentials and press Login button to continue to Main screen.

If DB44 is already in use you will be prompted shortly:



The screenshot shows the 'DB44 - TCP/IP FM Monitoring Tool' interface with the DEVA BROADCAST logo. Below the title bar is a 'Login' tab. The main content area displays the message: 'The device is in use. Please go [here](#) and try login again later.'

NOTE: DB44 will Logout automatically the current session after the defined WEB session timeout. (see "[Management Screen](#)" on page 37)

Operation

Web interface is visually divided into three parts:

- Top - Navigational Menu;
- Middle - specific contextual readings;
- Bottom - General Tuner and Channel readings, functional buttons.

NOTE: Bottom section of the Web interface is persistent regardless of the current screen, allowing immediate tuner interactions.

TUNER SCREEN

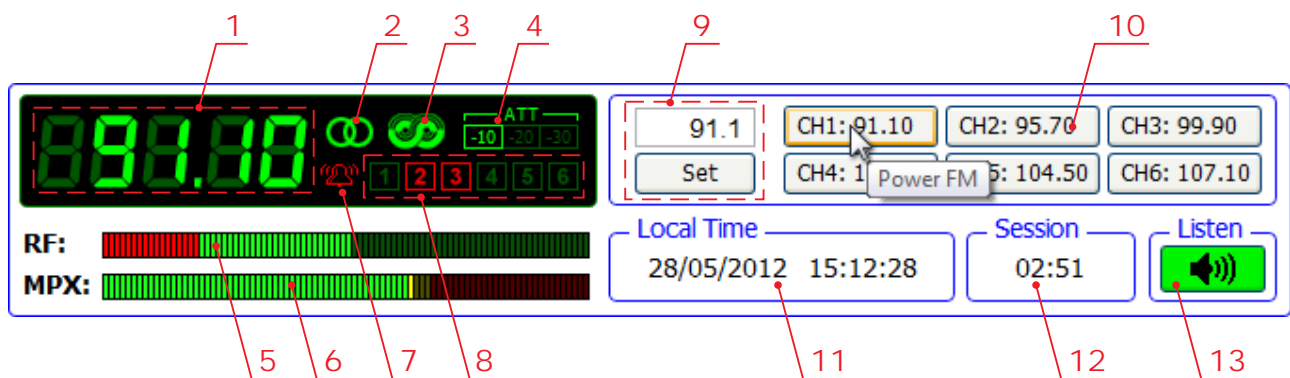

- 1 - Frequency indicator showing currently tuned frequency;
- 2 - Stereo indicator;
- 3 - RDS presence indicator;
- 4 - RF Attenuator Status;
- 5 - RF Level indicator, red zone (low level) is below 20 dB μ V;
- 6 - MPX Level indicator;
- 7 - Alarm presence indicator - lit red when at least one channel has alarm on it;
- 8 - Channel Alarms indicator - lit red when Scheduler has detected alarm on channel ([see "Channel Settings Screen" on page 32](#));
- 9 - Frequency set buttons;
- 10 - Channel Preset Buttons - when pressed sets the Tuner at predefined frequency. Upon hovering mouse over preset button, tip showing channel name is displayed;
- 11 - Device Time (["Management Screen" on page 37](#));
- 12 - WEB Session remaining time;
- 13 - Listen Button - toggles between Play and Stop the current audio stream through available Audio Device;

MAIN SCREEN

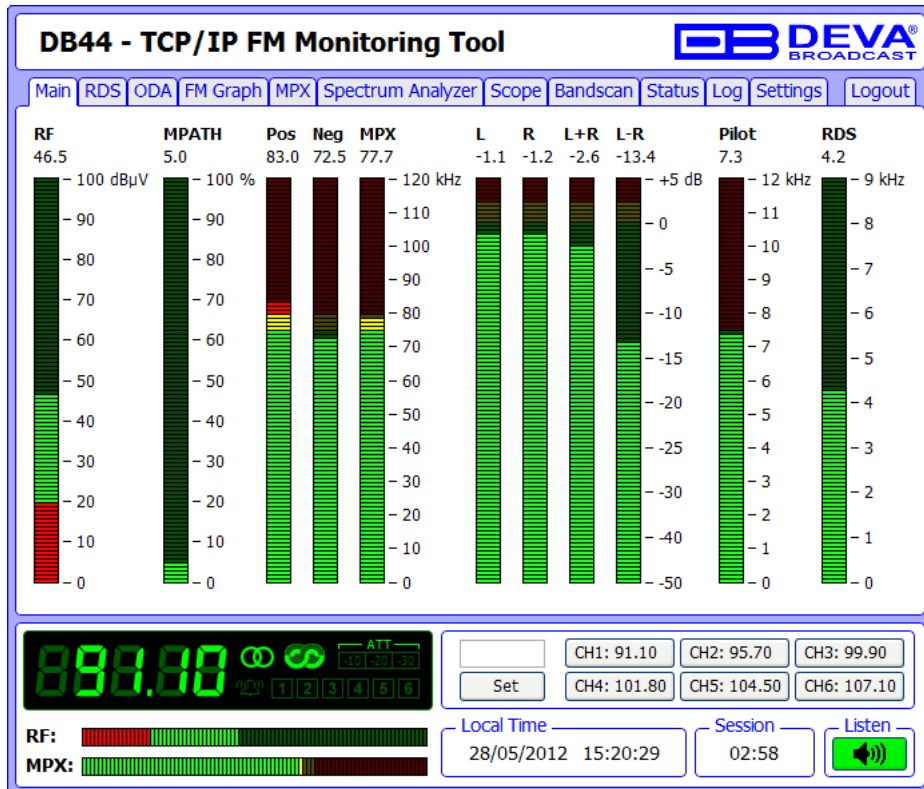

This screen shows all mandatory parameters represented as LED readings. It is possible to make fast evaluation of any selected station from this screen.

RDS SCREEN

DB44 - TCP/IP FM Monitoring Tool

Main
RDS
ODA
FM Graph
MPX
Spectrum Analyzer
Scope
Bandscan
Status
Log
Settings
Logout

PI: 8091 PS: POWER FM PTY: Pop Music MS: Music AF Total: 2
 AF Method: A
 RTA: POWER FM - TODAY'S BEST MUSIC
 RTB: _____
 DI: 1 Stereo, Not AH, Not compressed, Static PTY
 TP: Off TA: Off PIN:
 Date: 28 May 2012, Mon
 Time: 16:23 +03:00
 Total groups received: 156 \$ count
 A: 84\$ 15\$ 1\$ _____
 B: _____
 BER: 0.004

89.10
ATT 30 120 150

91.1

CH1: 91.10

CH2: 95.70

CH3: 99.90

Set

CH4: 101.80

CH5: 104.50

CH6: 107.10

RF:

MPX:

Local Time

28/05/2012 15:23:23

Session

02:37

Listen



This screen shows all mandatory RDS readings if there is RDS for the tuned station.

ODA SCREEN

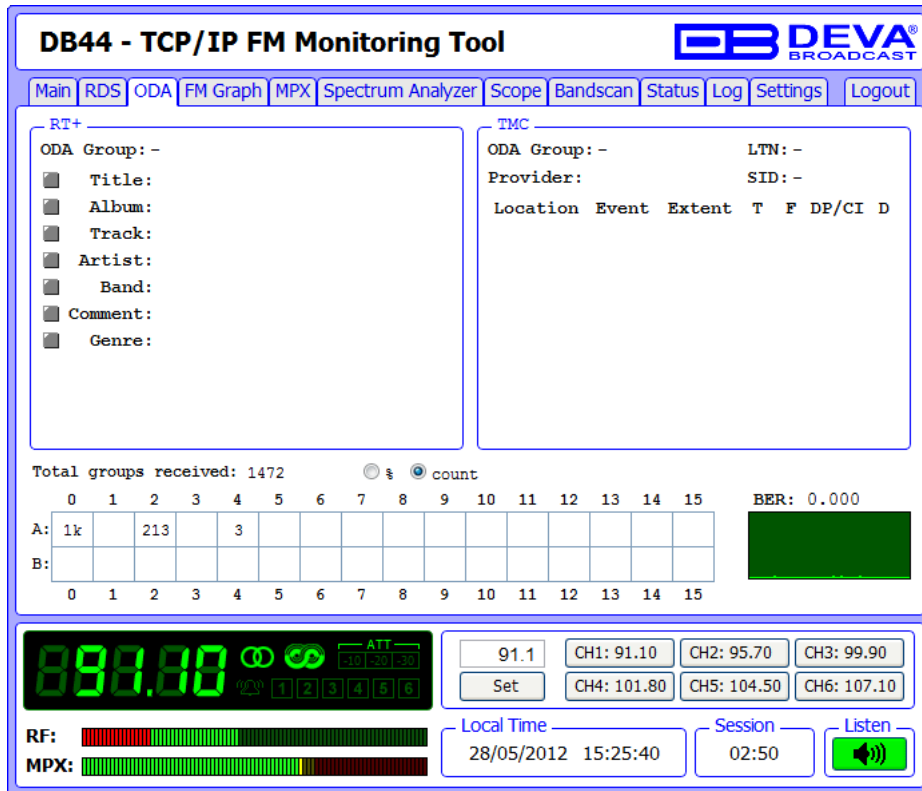

DB44 - TCP/IP FM Monitoring Tool

Main | RDS | ODA | FM Graph | MPX | Spectrum Analyzer | Scope | Bandscan | Status | Log | Settings | Logout

RT+

ODA Group: -

- Title:
- Album:
- Track:
- Artist:
- Band:
- Comment:
- Genre:

TMC

ODA Group: - LTN: -

Provider: SID: -

Location	Event	Extent	T	F	DP/CI	D

Total groups received: 1472 \$ count

	0	1	2	3	4	5	6	7	8	9	10	11	12	13	14	15
A:	1k		213		3											
B:																

BER: 0.000



RF:

MPX:

91.1	CH1: 91.10	CH2: 95.70	CH3: 99.90
Set	CH4: 101.80	CH5: 104.50	CH6: 107.10

Local Time: 28/05/2012 15:25:40 Session: 02:50 Listen 

This screen shows RT+ and TMC data if available.

FM GRAPH SCREEN

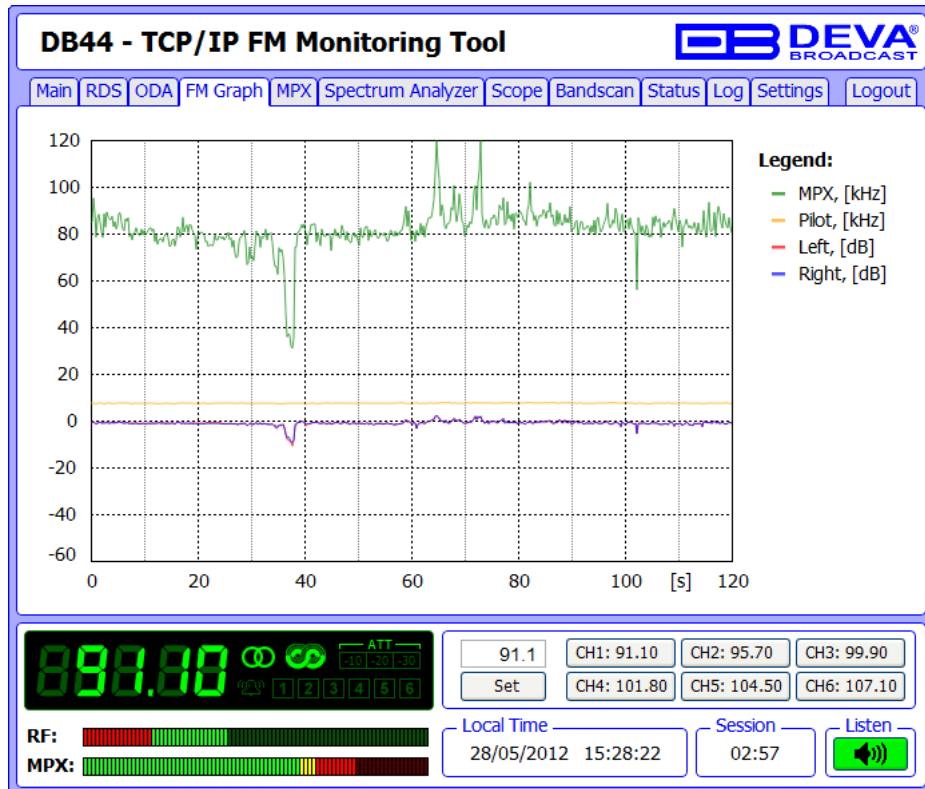

This screen represents all mandatory parameters in the time slice of 2 minutes.

Each parameter has its own color representation and measurement units, which are visible right-side from the graph. When RDS mode is selected - MPX and PILOT readings are in kHz, RBDS mode - in %.

MPX SCREEN

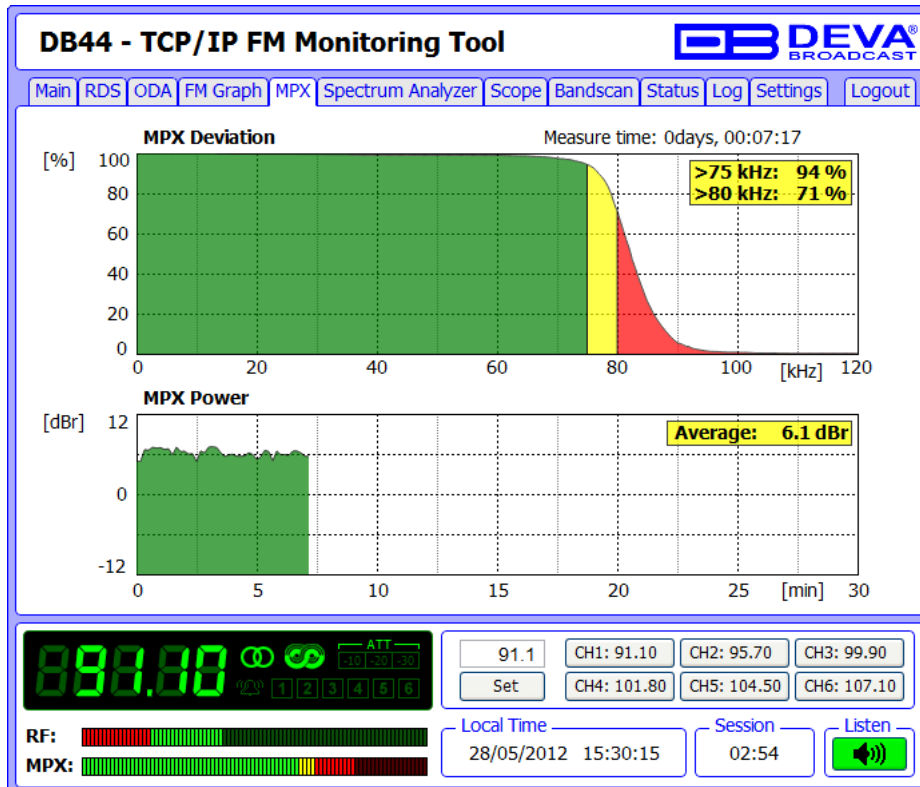

Above on this screen is shown Total MPX Deviation overshoot (in percentage) over time. Standard overshoot is measured at 75kHz and is indicated with the start of the yellow zone.

Below is shown MPX power value of the received signal. MPX Power is calculated continuously with integration window of 60 seconds and a new sample every 10 seconds. Therefore the first sample is available 60 seconds after tuning.

The rule of MPX Power provides to measure the modulation power, which is seen equal to modulating signal electric power, for one minute time period and to compare it to a sinusoidal modulating signal one which deviates $\pm 19\text{kHz}$. The result, expressed in dB, must be lower or equal to zero to comply the rule.

SPECTRUM ANALYZER SCREEN

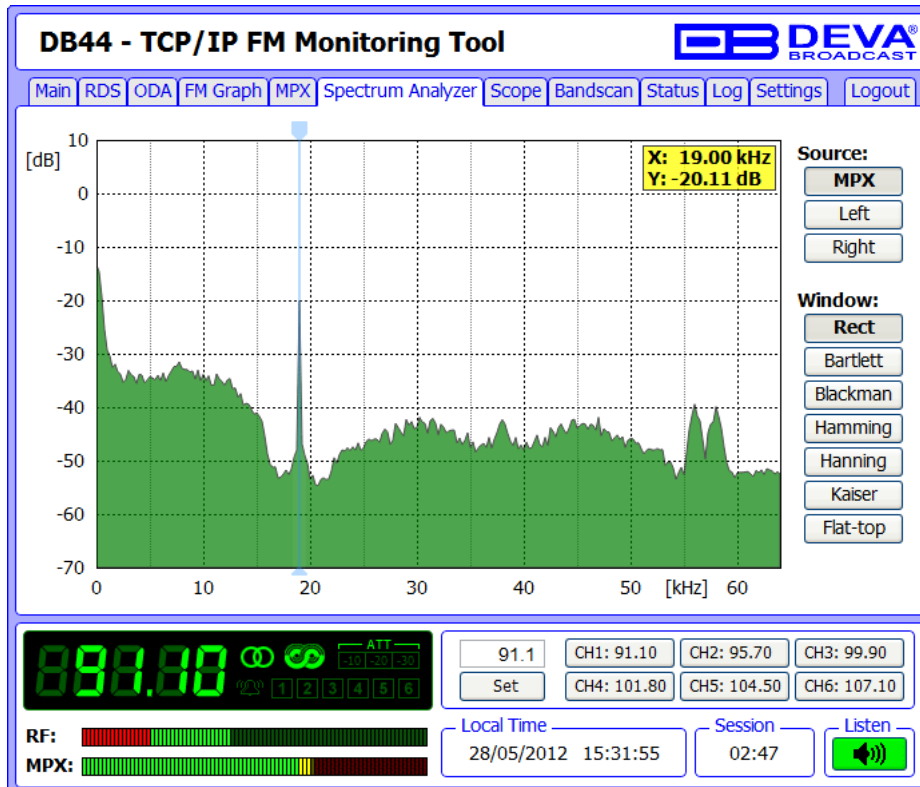

SPECTRUM Analyzer screen is used to visualize the spectral analysis of the input signal. Spectral components of the selected signal are determined on the base of Fast Fourier Transform.

Possible signal Sources are MPX, Left and Right. Possible Window Functions are Rectangle, Bartlett, Blackman, Hamming, Hanning, Kaiser, Flat-top.

User-defined frequency from the spectrum can be selected by moving vertical marker along the horizontal scale. Values at the cross-point will be shown at top right corner of the graph.

SCOPE SCREEN

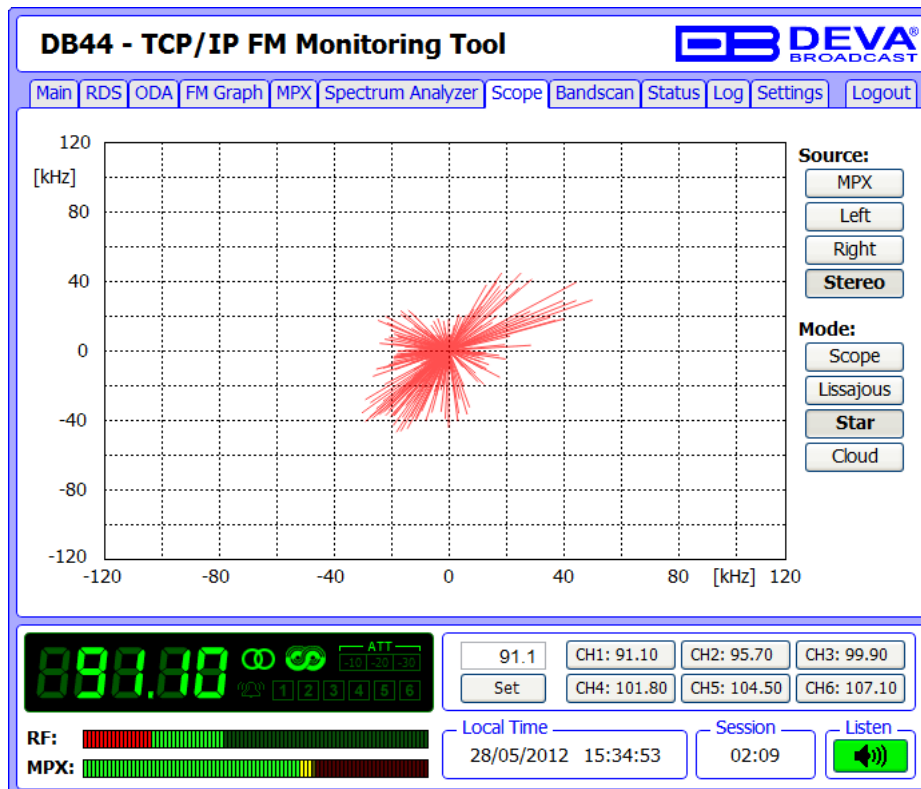

SCOPE screen is used to visualize the most important signals participating in the process of demodulating and stereo decoding. This screen represents the observed signal change over time.

To change source signal to be visualized press the corresponding button at the right-side of the graph. Stereo source visualizes Left and Right at once. When this source is selected the following visualization modes are available:

- Scope - standard 2 channel oscilloscope;
- Lissajous - Lissajous figure representation of Left vs. Right channel;
- Star - Star shaped representation of Left vs. Right channel;
- Cloud - Left vs. Right channel represented as cloud of points.

BANDSCAN SCREEN

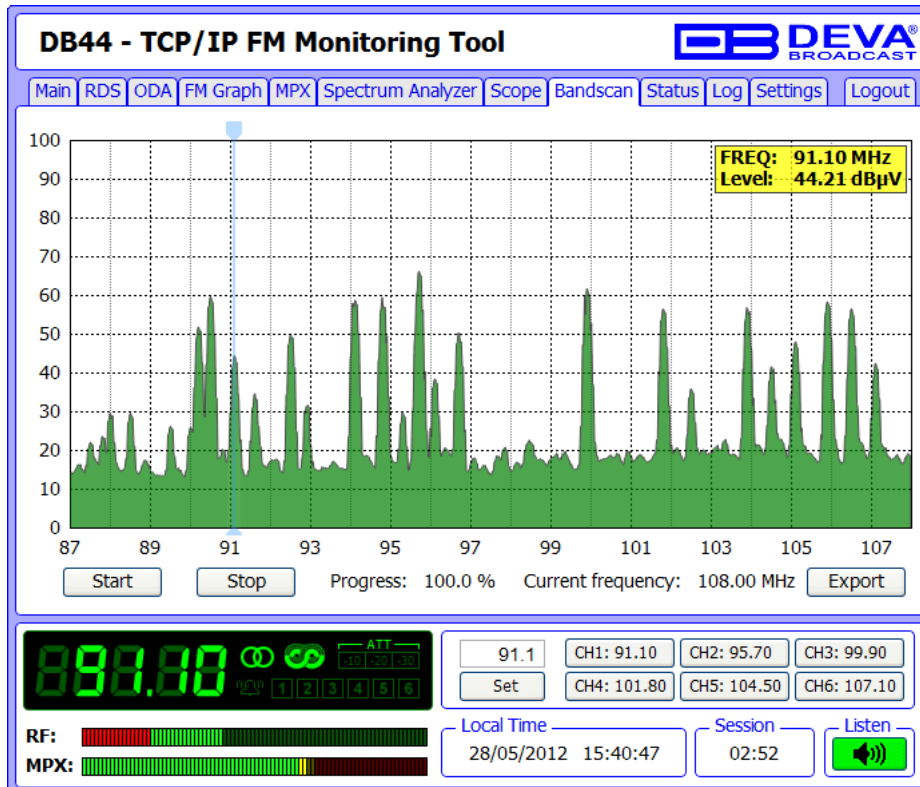

This Screen is used to evaluate FM broadcast band congestion by sweeping the tuner across FM band, logging every carrier and generating a spectrum display of carrier level vs. frequency.

To start the Bandscan process simply press the Start button and wait until process finishes. Bandscan could be stopped at any time by pressing the Stop button.

To evaluate the RF level of specified frequency move the vertical marker along the horizontal scale. Values at the cross-point will be shown at top right corner of the graph.

Press Export button to download the current Bandscan into CSV format.

STATUS SCREEN

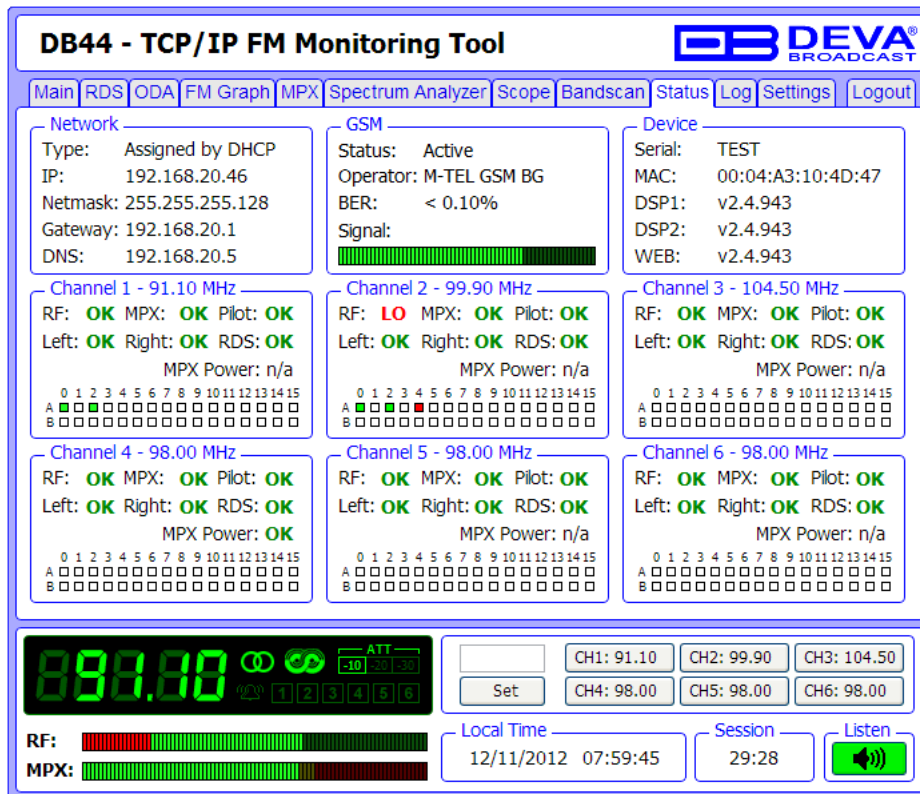

DB44 - TCP/IP FM Monitoring Tool

Network: Type: Assigned by DHCP, IP: 192.168.20.46, Netmask: 255.255.255.128, Gateway: 192.168.20.1, DNS: 192.168.20.5

GSM: Status: Active, Operator: M-TEL GSM BG, BER: < 0.10%, Signal: [Bar]

Device: Serial: TEST, MAC: 00:04:A3:10:4D:47, DSP1: v2.4.943, DSP2: v2.4.943, WEB: v2.4.943

Channel 1 - 91.10 MHz: RF: OK, MPX: OK, Pilot: OK, Left: OK, Right: OK, RDS: OK, MPX Power: n/a

Channel 2 - 99.90 MHz: RF: LO, MPX: OK, Pilot: OK, Left: OK, Right: OK, RDS: OK, MPX Power: n/a

Channel 3 - 104.50 MHz: RF: OK, MPX: OK, Pilot: OK, Left: OK, Right: OK, RDS: OK, MPX Power: n/a

Channel 4 - 98.00 MHz: RF: OK, MPX: OK, Pilot: OK, Left: OK, Right: OK, RDS: OK, MPX Power: OK

Channel 5 - 98.00 MHz: RF: OK, MPX: OK, Pilot: OK, Left: OK, Right: OK, RDS: OK, MPX Power: n/a

Channel 6 - 98.00 MHz: RF: OK, MPX: OK, Pilot: OK, Left: OK, Right: OK, RDS: OK, MPX Power: n/a

89.00 MHz [Buttons]

RF: [Bar] MPX: [Bar]

Local Time: 12/11/2012 07:59:45, Session: 29:28, Listen [Button]

This screen shows maintenance information about device. All information is helpful for service personnel and has relation only to device condition.

From here can be observed Network Configuration, Serial Number, MAC Address, Firmware Versions, GSM and Channels Status, when is necessary.

Every Channel parameter (RF, MPX, Pilot etc.) has several conditions:

- When in defined range - green OK. ([“Channel Settings Screen”](#) on page 32).
- Out of range - red LO or HI
- Channel Logging is off - n/a

RDS Groups Alarm statuses are displayed at the bottom of each channel’s section:

- Green - RDS Group is being received; no alarm;
- Red - RDS Group has not been received and alarm has been triggered;
- White (blank) - RDS Group is not been received and no alarm has been triggered.

LOG SCREEN

DB44 - TCP/IP FM Monitoring Tool

Main | RDS | ODA | FM Graph | MPX | Spectrum Analyzer | Scope | Bandscan | Status | **Log** | Settings | Logout

```

[26.05.2012, 20:00:19] Channel 3, RF : high : 60.3dBuV.
[27.05.2012, 02:42:55] Channel 6, RF : low : 38.4dBuV.
[27.05.2012, 04:14:07] Channel 6, RF : idle : 41.1dBuV.
[27.05.2012, 15:03:19] Channel 6, RF : low : 36.1dBuV.
[27.05.2012, 17:48:55] Channel 6, RDS : high : 16kHz.
[27.05.2012, 17:52:31] Channel 6, RDS Group: 2A loss.
[27.05.2012, 17:59:48] Channel 6, RDS Group: 2A recover.
[27.05.2012, 18:14:07] Channel 6, RDS Group: 0A loss.
[27.05.2012, 18:14:07] Channel 6, RDS Group: 2A loss.
[27.05.2012, 18:23:43] Channel 6, RDS Group: 2A recover.
[27.05.2012, 18:26:11] Channel 6, RDS Group: 0A recover.
[27.05.2012, 18:40:32] Channel 6, RDS Group: 0A loss.
[27.05.2012, 18:44:08] Channel 6, RDS Group: 2A loss.
[27.05.2012, 18:49:05] Channel 6, RDS Group: 0A recover.
[27.05.2012, 18:54:56] Channel 6, RDS Group: 0A loss.
[27.05.2012, 18:54:56] Channel 6, RDS Group: 2A recover.
[27.05.2012, 19:02:08] Channel 6, RDS Group: 0A recover.
[27.05.2012, 19:48:55] Channel 6, RDS : idle : 6.4kHz.
[27.05.2012, 20:05:43] Channel 6, RF : idle : 42.7dBuV.
[28.05.2012, 05:21:19] Channel 6, RF : low : 38.3dBuV.
[28.05.2012, 06:02:08] Channel 6, RF : idle : 40.9dBuV.
                
```

General Channel 1 Channel 2 Channel 3 Channel 4 Channel 5 Channel 6

898.00

ATT
30
20
10

RF:**MPX:**

Local Time
 28/05/2012 15:54:23

Session
 02:56

This screen shows the Device Log, which holds last 100 important events. Channel specific events could be filtered out by checking corresponding check-boxes.

SETTINGS SCREEN

WARNING: All Changes takes effect after pressing the **SAVE button**. All settings marked with  requires Reboot, thus use **Save & Reboot button**. Navigating between screens will revert changes from last save.

NOTE: The field to be edited will fall red if the new value is invalid or out of range.

Main Settings Screen

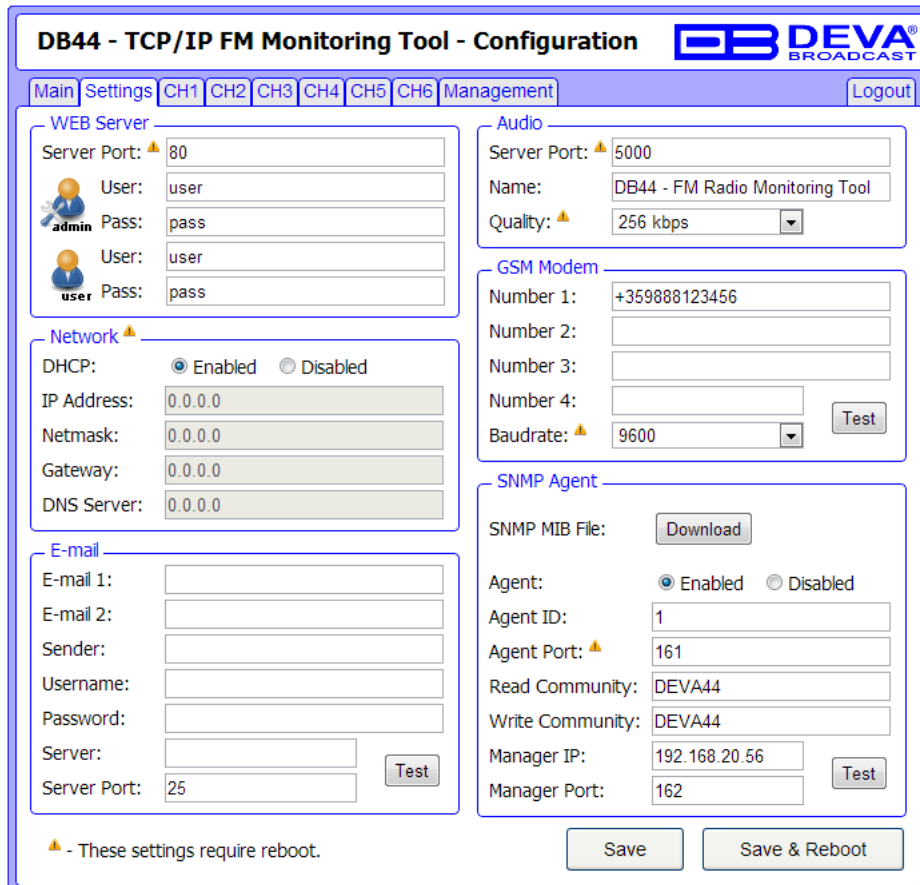

DB44 - TCP/IP FM Monitoring Tool - Configuration

Main Settings CH1 CH2 CH3 CH4 CH5 CH6 Management Logout

WEB Server

Server Port:  80

User: user

Pass: pass

User: user

Pass: pass

Network 

DHCP: Enabled Disabled

IP Address: 0.0.0.0

Netmask: 0.0.0.0

Gateway: 0.0.0.0

DNS Server: 0.0.0.0

E-mail

E-mail 1:

E-mail 2:

Sender:

Username:

Password:

Server:

Server Port: 25

Audio

Server Port:  5000

Name: DB44 - FM Radio Monitoring Tool

Quality:  256 kbps

GSM Modem

Number 1: +359888123456

Number 2:

Number 3:

Number 4:

Baudrate:  9600

SNMP Agent

SNMP MIB File:

Agent: Enabled Disabled

Agent ID: 1

Agent Port:  161

Read Community: DEVA44

Write Community: DEVA44

Manager IP: 192.168.20.56

Manager Port: 162

 - These settings require reboot.

Network:

There are two ways to setup the network addresses: manually (static IP) and automatically via DHCP client.

Setting DHCP field to Enable will activate the built-in DHCP Client. As a result all network addresses will be read-only. When DHCP Client is active all the assigned values will be shown in the relevant fields into "[Status Screen](#)". If for some reason the DHCP procedure can not be completed DB44 uses AutoIP to generate IP Address. It is recommended to check the following items:

- Network cable;
- Whether the LAN Interface is enabled;
- Ping availability to the DHCP Server's IP;
- Sufficient address space for distribution by the DHCP server;

To setup IP, MASK, GATEWAY and DNS addresses manually, first set DHCP to Disabled, then using corresponding fields change addresses to appropriate values.

E-mail:

Enter desired alarm recipients into E-mail 1 and/or E-mail 2 fields. If left blank no e-mails will be sent. Fill your e-mail credentials into Sender, Username and Password as well Server and corresponding port.

Use Test button to generate test e-mail, which on success will be delivered to specified E-mail 1 and/or E-mail 2.

Example of Test E-mail Message:

DB44 Test Message.

Please do not reply to this e-mail.

WEB Server:

Enter desired Port, Username and Password to be used when accessing WEB Server.

There are 2 levels of access. *Admin* can access all screens and change all settings. *User* can access only the operational screens. *User* has no access to the settings screens.

Audio:

Specify Port for audio Streaming, Name of the stream (which is used also for e-mail sender name and web title) and Quality (64, 96, 128, 192 or 256 kbps).

Audio Stream could be listen by using suitable Audio Player (MS Media Player or Winamp) or through Web interface by pressing the Listen Button ([see "Tuner Screen" on page 19](#)).

GSM Modem:

Enter up to four numbers which will receive SMS notifications generated by Scheduler.

SIM PIN and Baudrate are mandatory for GSM Modem to operate.

NOTE: Look under "[Status Screen](#)" to check the GSM Modem current condition.

Use Test button to generate test SMS, which on success will be delivered to all specified GSM numbers.

Example of Test SMS Message:

DB44 Test Message

ATTENTION: Consult with your network administrator for the appropriate Port settings.

SNMP:

Specify Agent ID, Agent Port, Read/Write Communities, Manager IP and Manager Port.

NOTE: Agent ID is used to identify the device among others when a SNMP notification is send.

Agent - enables/disables SNMP Agent.

Use Test button to generate test notification, which on success will be received by the Manager.

Press the Download button to download DB44 SNMP MIB file.

NOTE: The MIB file may change from one firmware revision to the other. Downloading this file from the device ensures that you have the proper MIB file.

Channel Settings Screen

DB44 could manage up to 6 user-defined channels. Every Channel consist of group of settings, which are used when scheduling, monitoring and alerting.

Channels are tuned one after another. DB44 stays tuned about 10 seconds at every active channel.

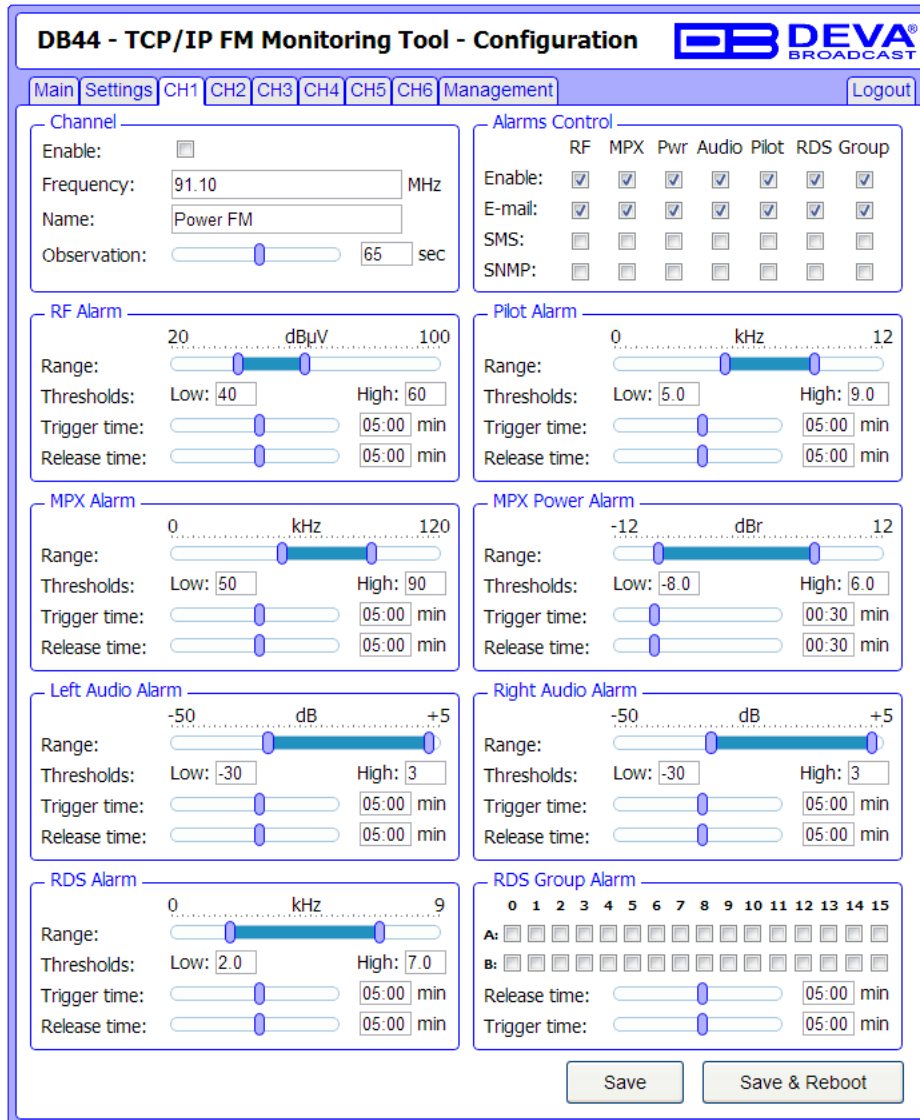

Channel:

- Enable - enables/disables channel monitoring;
- Frequency - frequency to be tuned and monitored;
- Name - channel alias;
- Observation - time to stay tuned on this channel, before switching to next channel.

NOTE: When MPX Power alarm is enabled the observation time must be greater than 70 seconds.

Alarm Control:

- Enable - enables/disables corresponding parameter alarm logging;
- E-mail - enables/disables E-mail notification;
- SMS - enables/disables SMS notification;
- SNMP - enables/disables SNMP notification.

NOTE: If monitoring is disabled, notifications will not be sent no matter what notifications are enabled or disabled.

Clicking on label (left or above) will enable/disable entire column/row.

Alarm:

- Range - interactive slider to adjust Low & High Threshold;
- Threshold Low & High - if parameter falls outside this range alarm will be generated.
- Trigger Time - time to wait before Active Alarm is generated;
- Release Time - time to wait before Idle Alarm is generated;
- RDS Group Alarm - check each group of interest. Alarm is generated only for selected groups.

ALARM TRIGGERS DEFINED

After collecting all the data the DB44 DSP core compares the values measured with the predefined by the user threshold levels for all the channels monitored. In case that any parameter is out of its limits, the device will initiate the sending of alarm notification via the alarm type selected. All the alarms are stored in the device's log. You have to have in mind that, if there is a very short fault of the signal, with duration less than the 'channel trigger time', the device would not trigger an alarm.

There are several Alarm Triggers for the following parameters: RF, MPX, MPX Power, Left/Right Audio, RDS and Pilot levels. There is an option for defining different limits for each of the parameters. All these values, the 'trigger time' and the 'release time' have to be assigned separately for each of the channels.

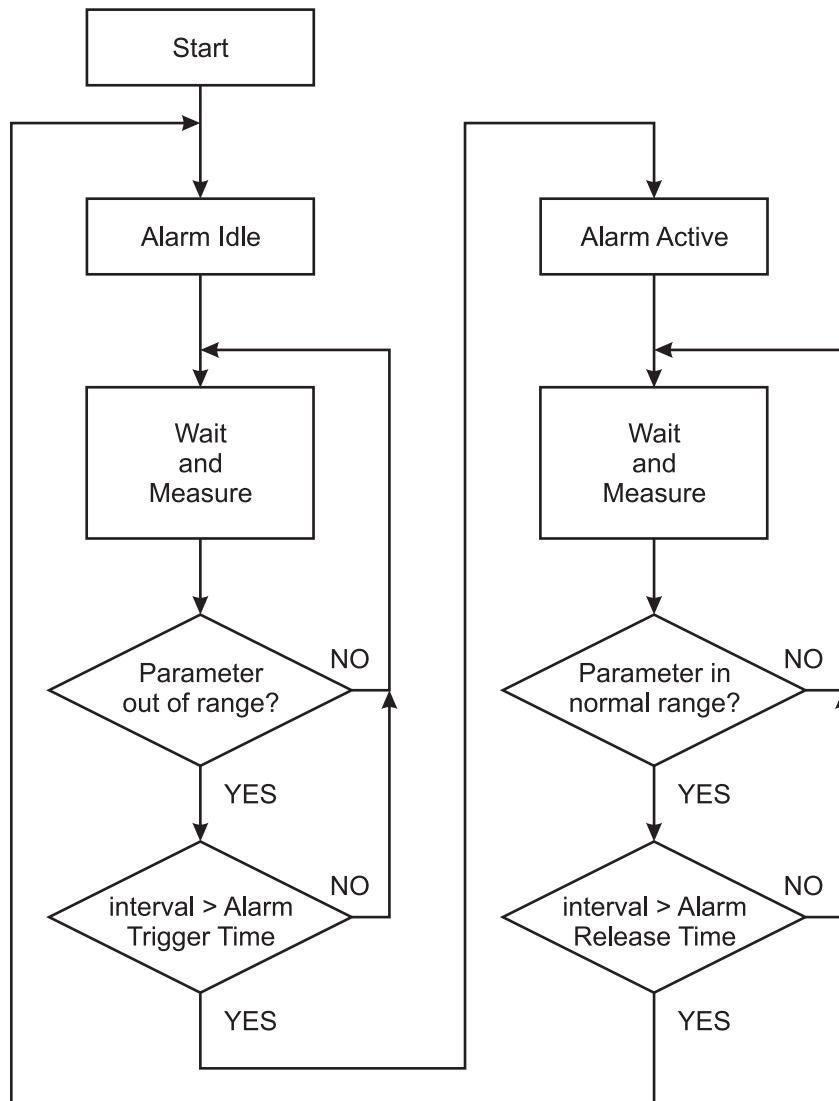

Block Diagram of Alarm Automata

Every time an observation event takes place, the Alarm Trigger's State of the channel refreshes (if necessary). For example: Let's suppose that the Alarm Trigger is in Idle state. Note, that an alarm is not triggered immediately when a parameter level passes over threshold (above High Threshold or under Low Threshold). If the parameter level becomes stable (within Thresholds) and Alarm Trigger Time is not elapsed, then Alarm Trigger remains in Idle state. If Alarm Trigger Time expires and the parameter level is still out of bounds, then Alarm Trigger changes its state to Active. This causes predefined actions - Alarm Notifications (E-mail, SMS, SNMP trap) and Save a Log Record. The state will not be immediately changed to Idle when the parameter stabilizes (within Threshold levels), but will wait until 'Alarm Release Time' is elapsed. Meanwhile if the parameter passes over again any Threshold, the Alarm Trigger will remain in Active state. If the parameter remains within Threshold levels and Alarm Release Time expires, Alarm Trigger switches to Idle state and again predefined actions are initiated (as when entering Active state).

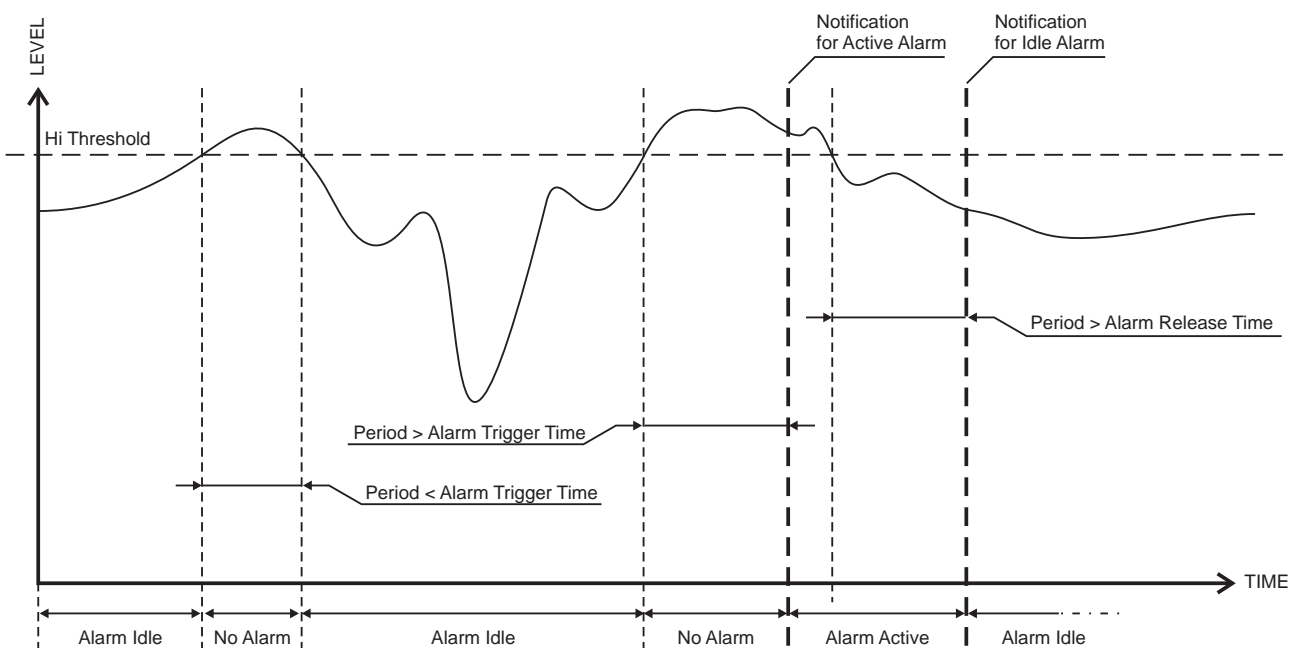

If RDS Group has not been received for more than Alarm Trigger Time state is changed to Active. If state is Active and Release Time has elapsed and the RDS Group is received state is changed to Idle. If the RDS Group is received before the Release Time is elapsed state remains Active.

ALARM NOTIFICATIONS

Alarm Notifications (E-mail, SMS, SNMP trap) consist of DB44 Alias (see [“Main Settings Screen”](#) on page 30), date and time of Alarm triggered, channel number, frequency and information for Alarm activation or deactivation. The basic signal parameters are evaluated and included as well.

Because of the SMS length limitations, only most important parameters are included, when sending SMS Notifications.

Example for E-mal Notification:

Date: 27 Sep 2011, 09:05:09

DB44 - FM Radio Monitoring Tool reports ACTIVE alarm on 95.70MHz - BG Radio (CH2)

Alarm: RF < 40dBuV

Signal parameters:

RF Level: 64.6 dBuV

MPX: 65.8 kHz

Left: -1.6 dB

Right: -1.9 dB

Pilot: 7.95 kHz

RDS: 4.47 kHz

Multipath: 3.3 %

Example for SMS Notification:

ACTIVE ALARN:CH#2

27.09.2011 09:08:34

FREQ:95.7MHz

RF:35.0dBuV *L*

MPX:60.3kHz

Left:-2.8dB

Right:-3.1dB

Pilot:7.92kHz

RDS:4.12kHz

NOTE: *L* for LOW (below threshold), *H* for HIGH (above threshold)

MANAGEMENT SCREEN

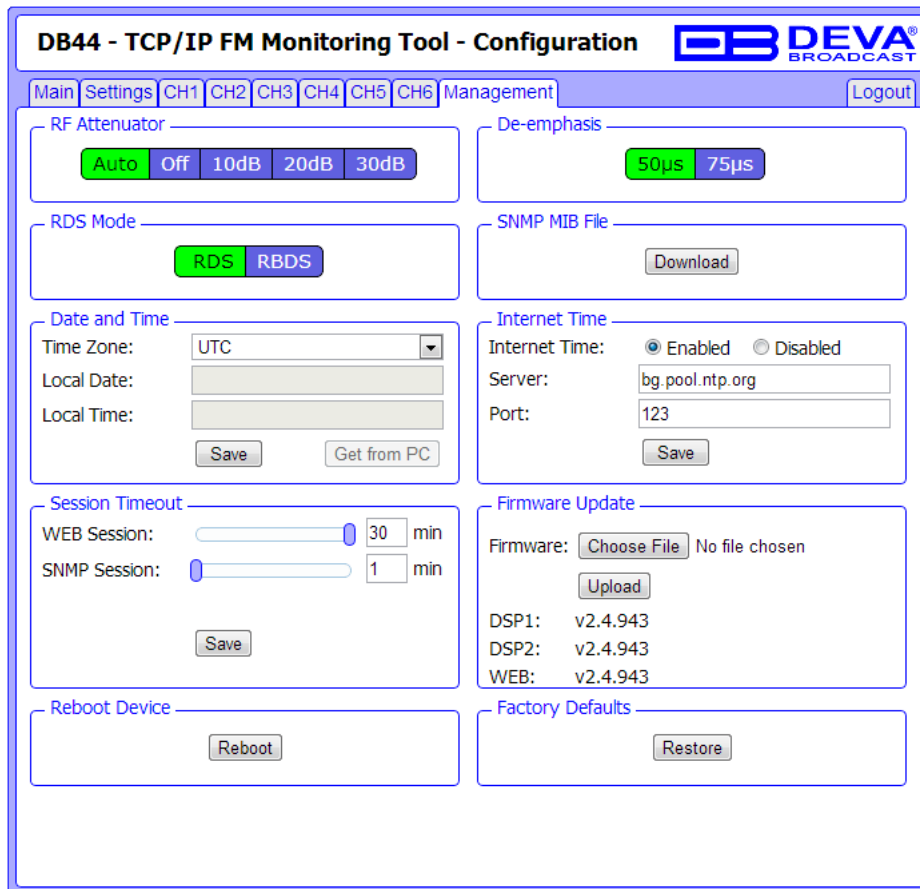

The screenshot displays the 'Management' configuration page for the DB44 device. The interface includes a navigation bar with tabs for 'Main', 'Settings', 'CH1', 'CH2', 'CH3', 'CH4', 'CH5', 'CH6', and 'Management'. A 'Logout' button is located in the top right corner. The configuration is organized into several sections:

- RF Attenuator:** Buttons for 'Auto', 'Off', '10dB', '20dB', and '30dB'. 'Auto' is currently selected.
- De-emphasis:** Buttons for '50µs' and '75µs'. '50µs' is currently selected.
- RDS Mode:** Buttons for 'RDS' and 'RBDS'. 'RDS' is currently selected.
- SNMP MIB File:** A 'Download' button.
- Date and Time:** Fields for 'Time Zone' (set to UTC), 'Local Date', and 'Local Time'. Includes 'Save' and 'Get from PC' buttons.
- Internet Time:** Radio buttons for 'Enabled' (selected) and 'Disabled'. Fields for 'Server' (bg.pool.ntp.org) and 'Port' (123). Includes a 'Save' button.
- Session Timeout:** Sliders for 'WEB Session' (30 min) and 'SNMP Session' (1 min). Includes a 'Save' button.
- Firmware Update:** 'Choose File' button, 'Upload' button, and status for 'DSP1', 'DSP2', and 'WEB' (all v2.4.943).
- Reboot Device:** A 'Reboot' button.
- Factory Defaults:** A 'Restore' button.

RF Attenuator: Indicates the Antenna Input Attenuator's setting. Attenuation level can be selected by pressing the desired value button. When AUTO is selected DB44 adjusts automatically the Attenuator's position.

De-emphasis: Indicates currently selected De-emphasis.

Date and Time / Internet Time: When Internet Time is enabled, DB44 automatically will adjust its internal clock through internet. When Internet Time is disabled, Date and Time must be entered into corresponding fields or filled from PC Clock by pressing the 'Get From PC' button.

NOTE: Time Zone is not affected when synchronizing through internet.

Firmware Update: The DB44 firmware can be updated if desired. By updating the firmware, new function(s) can be added, improvement of performance parameters can be obtained and bugs detected during service time can be corrected. To update the device firmware, please follow the next steps:

- Select the new firmware file by pressing the 'Browse'/'Choose File' button;
- Press the "Upload" button;
- Wait for the process to complete.

Reboot Device: Pressing Reboot button initiates a 'hardware reset' equivalent to turning the DB44 off and back on again. This reset command does not clear any previously saved settings.

Factory Defaults: When an emergency recover is necessary, which probably will never be used, DB44 can Restore Factory Defaults from its non-volatile memory.

Press Restore Button. If intended to Restore Factory Defaults, please confirm.

See “[Factory Default Settings](#)” on page 10 for detailed listing of Factory Settings.

WARNING: Perform Emergency Recover with caution because any remote users would not be aware, hence they may cease to communicate with device.

Session Timeout: Set WEB and SNMP sessions timeout. During each session Logger is not active, thus no Alarms are generated.

SNMP MIB File: Press the Download button to download DB44 SNMP MIB file.

NOTE: The MIB file may change from one firmware revision to the other. Downloading this file from the device ensures that you have the proper MIB file.

EXTERNAL GSM MODEM SETTINGS

To fulfill the Remote Monitoring Functions via GSM it is necessarily to connect an external GSM modem to DB44. To do this, connect the GSM Modem to the rear panel DB-15 male connector through the cable provided together with GSM Modem. A GSM Antenna must be supplied and connected to the connector of the GSM Modem.

IMPORTANT: Position the GSM Antenna as far as possible from the DB44's FM Antenna.

WARNING: Please check SIM Card PIN request to be disabled. Otherwise DB44 can not operate the modem.

The GSM Modem must be configured with the following settings:

Baud rate: equal to DB44 setting (see "[Main Settings Screen](#)" on page 30)

Data bits: 8

Stop bit: 1

Parity: None

Hardware Flow Control: None

NOTE: The GSM Modems provided by DEVA Broadcast Ltd. are pre-configured. In case of using different modems, please comply with the settings above.

To ensure proper installation of the GSM Modem, please observe the following sequence:

1. Install and connect the GSM Antenna according to the above recommendations.
2. Insert the SIM card into the holder. Card must be with deactivated PIN request.
3. Connect the GSM Modem and DB44 with the communication cable.
4. Power-up the GSM Modem.
5. Power-up DB44.

If the installation is proper, the GSM Modem will immediately startup. This will be noticed by the fast blinking of the 'GSM' Led on the DB44's front panel. The status of the GSM Modem will also be exposed on "[Status Screen](#)". Few seconds are usually necessary for the GSM Modem to initialize and to register into the GSM Network. When the GSM Modem is Ready the 'GSM' Led will start blinking slowly. The GSM Opeartor's Logo and the Field Strength will be also shown on the "[Status Screen](#)".

It is important to notice the call duration, which is 1 minute, otherwise the GSM connection may turn overused. 'Call Duration' defines the maximum outgoing call duration, which will be hanged-up by DB44 when it reaches the defined value (1 minute).

Only authorized GSM numbers can request remote notifications and remote listening. To register up to four GSM numbers use Main Settings Screen.

It is important to enter the GSM numbers properly, using the correct prefix for the country. For example: +359898123456

NOTE: The GSM Modem may be connected to DB44 without shutting down the device - so called 'Hot Plug'. When disconnected or powered down, the GSM Modem can be reconnected after the 'GSM' Led stops blinking (about 5 seconds). To prevent possible problems, we recommend, when possible, not to use 'Hot Plug'.

‘Status Request’ Command Format:

Status FFF.FF

‘Remote Audio Listening’ Command Format:

Listen FFF.FF

Where FFF.FF is the frequency to Tune in the range of 87 to 108 MHz.

For example: “Status 102.55” or “Listen 88.80”.

IMPORTANT: Do not include leading zeroes such as “Listen 089.90”. Fill in with trailing zeroes up to two digits after the decimal symbol. Decimal symbol must be “.” (dot)

If DB44 receives an authorized ‘Status Request’ command, after a short interval (about 5 seconds), in which DB44 has to retune and collect summarized data, the Caller will receive a SMS response. For Example:

```
STATUS :  
27.09.2011 09:08:34  
FREQ:102.50MHz  
RF:32.7dBuV  
MPX:103.2kHz  
Left:-4.8dB  
Right:-4.9dB  
Pilot:7.5kHz  
RDS:18.5kHz
```

‘Remote Audio Listening’ command will generate (only if the calling number is authorized) a response call from DB44 to the command sender. DB44 will wait for answer, and will hang-up after 30 seconds, if there is no incoming answer. When a call is accepted, the duration of ‘listening’ is determinate by ‘Call Duration’ interval or until the call is ended.

UPnP and DB44 discovery in Local Networks

DB44 implements UPnP which lets you easily find it in your local network. For this purpose your system should have UPnP enabled (see “UPnP Activation” on page 42). To discover the device follow the next steps:

- Connect the device to the local network.
- Open “My Network Places” on your computer.
- Find the decoder’s icon.
- Double click it to open the DB44 web interface.

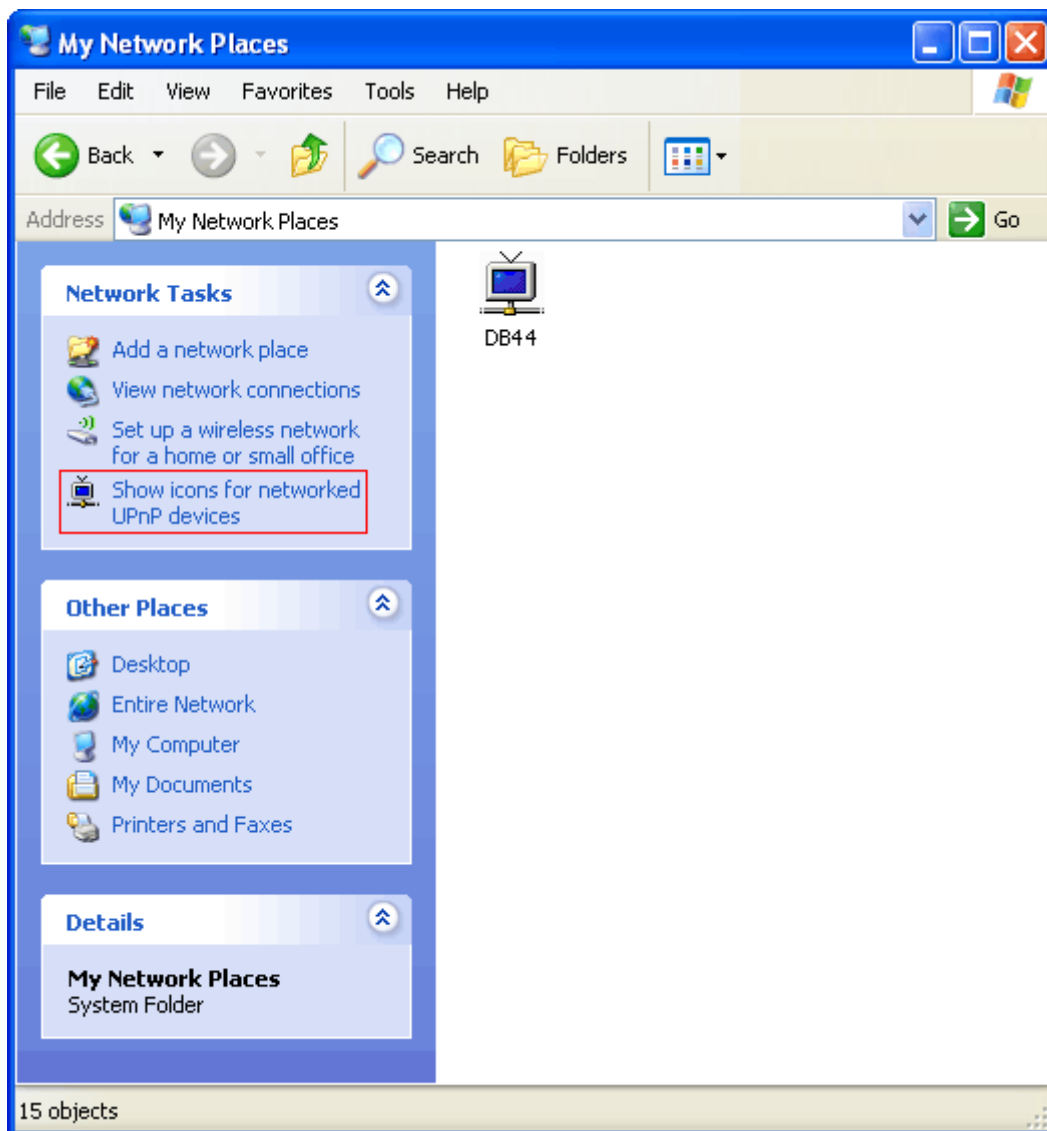

UPnP Activation

NOTE: The following explanations apply to Windows XP SP2 or SP3! If you use another operating system, please contact your system administrator.

Open “My Network Places”. If you have the caption displayed in the picture below, click on it. Then click “Yes” and wait for the process to complete. Now you should see the device. If you still have troubles finding the device, please see

<http://support.microsoft.com/kb/941206> or contact your system administrator.

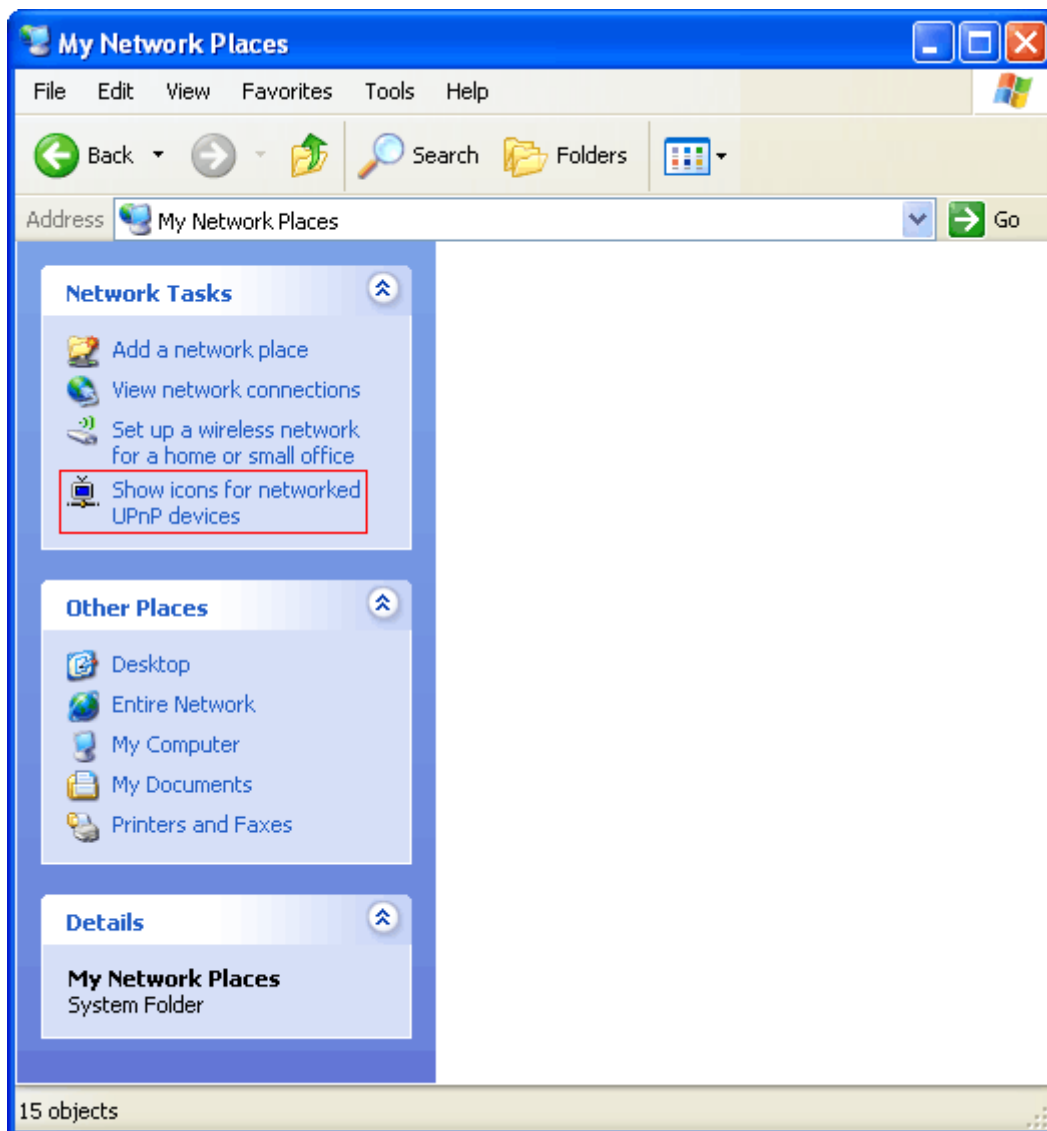

WARRANTY TERMS AND CONDITIONS

I. TERMS OF SALE: DEVA Broadcast Ltd. products are sold with an understanding of “full satisfaction”; that is, full credit or refund will be issued for products sold as new if returned to the point of purchase within 30 days following their receipt, provided that they are returned complete and in an “as received” condition.

II. CONDITIONS OF WARRANTY: The following terms apply unless amended in writing by DEVA Broadcast Ltd.

A. The Warranty Registration Card supplied with this product must be completed and returned to DEVA Broadcast Ltd. within 10 days of delivery.

B. This Warranty applies only to products sold “as new.” It is extended only to the original end-user and may not be transferred or assigned without prior written approval by DEVA Broadcast Ltd.

C. This Warranty does not apply to damage caused by improper mains settings and/or power supply.

D. This Warranty does not apply to damage caused by misuse, abuse, accident or neglect. This Warranty is voided by unauthorized attempts at repair or modification, or if the serial identification label has been removed or altered.

III. TERMS OF WARRANTY: DEVA Broadcast Ltd. products are warranted to be free from defects in materials and workmanship.

A. Any discrepancies noted within TWO YEARS of the date of delivery will be repaired free of charge, or the equipment will be replaced with a new or remanufactured product at DEVA Broadcast Ltd. option.

B. Parts and labor for factory repair required after the one-year Warranty period will be billed at prevailing prices and rates.

IV. RETURNING GOODS FOR FACTORY REPAIR:

A. Equipment will not be accepted for Warranty or other repair without a Return Authorization (RA) number issued by DEVA Broadcast Ltd. prior to its return. An RA number may be obtained by calling the factory. The number should be prominently marked on the outside of the shipping carton.

B. Equipment must be shipped prepaid to DEVA Broadcast Ltd.. Shipping charges will be reimbursed for valid Warranty claims. Damage sustained as a result of improper packing for return to the factory is not covered under terms of the Warranty and may occasion additional charges.

PRODUCT REGISTRATION CARD

- All fields are required, or warranty registration is invalid and void

Your Company Name _____

Contact _____

Address Line 1 _____

Address Line 2 _____

City _____

State/Province _____ ZIP/Postal Code _____

Country _____

E-mail _____ Phone _____ Fax _____

Which DEVA Broadcast Ltd. product did you purchase? _____

Product Serial # _____

Purchase date ____ / ____ / ____

Installation date ____ / ____ / ____

Your signature*

*Signing this warranty registration form you are stating that all the information provided to DEVA Broadcast Ltd. are truth and correct. DEVA Broadcast Ltd. declines any responsibility for the provided information that could result in an immediate loss of warranty for the above specified product(s).

Privacy statement: DEVA Broadcast Ltd. will not share the personal information you provide on this card with any other parties.