

**Note (Please Read before Use)**

---

Smart-i Incorporation reserves the rights of interpretation to this "instruction manual ".

λ All GPS map data and license(s) attached in the device are solely for Navigational purposes.

**Please DO NOT attempt to alter and/or duplicate the GPS data and license(s).**

λ Users are to read the operation instructions carefully before use to avoid mishandling and/or misuse of product.

λ The Portable GPS system shall be fitted in a position that DOES NOT visually affects the driver.

λ Please note in certain countries, it is NOT LEGAL to access multimedia programs while driving. The company WILL NOT be responsible for any user breaching the rules and regulations set by relevant Traffic Authorities of respective countries.

---

## Contents

1. BASIC USE	4
2. MAIN FUNCTIONS AND OPERATIONS	5
2.1. FLASH PLAYING	5
2.2. VIDEO PLAYING	5
2.3. MUSIC PLAYING	6
2.4. BLUETOOTH	6
2.5. PICTURE	8
3. TOOLS	9
3.1. CALCULATOR	9
3.2. WINDOWS	9
3.3. FM	9
4. SYSTEM SETTINGS	10
4.1. BACKLIGHT SETTING	10
4.2. POWER SETTING	10
4.3. SOUND	10
4.4. SYSTEM INFO	10
4.5. CALIBRATE TOUCH SCREEN	10
4.6. UPDATE LOGO	10
4.7. FILE MANAGEMENT	10
4.8. AV IN SET	10
4.9. GPS PATH	10
5. QUICK TROUBLESHOOTING	11
6. DISCLAIMER	12
7. IMPORTANT MESSAGES	12
8. TECHNICAL SUPPORT	12

# USER MANUAL



---

## Road Runner Series 41

### Model IDP4301

---

## 1. Basic use

### Battery

Battery status icon:



【Attention】 Please charge the battery if the status is low.

### Power charging

#### Attention:

1. The new battery may not be charged initially
2. 8 to 16 hours is needed for the first three times of charging
3. Ensure subsequent charging of 2 to 4 hours when using a DC adapter.

#### 【Attention】

1. In the event that the unit has been idle for over 60 days, charge the unit for a minimum of 6 hours prior to use.
2. Discharge the battery if the device is not being used for a period longer than 90 days.

### Powering On & Off:

Press and hold the “Power” button to power the equipment on / off.

### Sleeping mode (Activate by pressing the “Power” button once):

While in sleeping mode, all programs stop working, and resume operation mode after starting up.

The device could toggle to sleeping mode automatically or manually by the 2 methods below:

1. Press “Power” button once to activate sleeping mode.
2. The device will change to sleeping mode when there is no operation for a period preset by the user.

Starting up while in sleeping mode:

Press and hold power key to resume operation mode.

### Shutdown

The device will automatically shut down after full consumption of the internally built battery.

### Internal Flash Drive

The internal flash drive of the device contains the map software, GPS Navigation data and map license.

Users can store their multimedia files to the internal flash drive.

Note: For USA customers, there will be an internal flash of 2Gigabyte. Navigation software and data will utilize approximately 1.4 Gigabyte. Users can make use of the remaining 500Megabyte of free space for multimedia storage.







## 2. Main functions & operations

### 2.1 Flash Multimedia Files.

From the device's main menu, tap [Flash] icon to enter into flash folder.

Tap  to search your favorite, tap  to exit; tap  to play the selected file.

**Control buttons in playing mode:**

	Play	Play
	Pause	Click to pause playing
	Stop	Click to stop playing
	Forward	Click for forwarding
	Backward	Click for reversing
	Full screen	Click for full screen playing mode
	Return	Click to return to main interface when playing

**[Attention]** In full screen playing mode, the tool bar is hidden. Simply tap the screen for the tool bar to appear.

### 2.2 Video playing

**Support video files in AVI, MPEG, MPG, MOV, DAT, ASF, RM, RMVB and WMV formats.**

In main menu, tap [Video] icon to enter into video folder:

Tap  to search your favorite, tap  to exit; tap  to play the selected file.

**Control button in playing mode:**

	Play		Next
	Pause		Last
	Stop		Full screen playing
	Close		

**[Attention]** In full screen playing mode, the tool bar is hidden. Simply tap the screen for tool bar to appear.









## 2.3 Music playing

### Support MP3, WMA formats.

In main menu, tap 「Music」 icon to enter into music folder.

Tap  to search your favorite, tap  to exit, tap  to play the selected file.







### Soft keys information:

-  pause,
-  play
-  stop
-  next
-  previous
-  play in sequence.
-  volume on/off
-  return to the system main interface

## 2.4 Bluetooth (Optional)

Tap 「Bluetooth」 for Bluetooth menu.





### Control button:

	Close	Close the current dialog box
	Phone keyboard	Dial-up directly
	Call history	Display call history
	The last call	Display the last call
	Pairing	Pairing with a Mobile Phone or other Bluetooth device
	Bluetooth Setting	Setting Bluetooth parameters
	Pairing equipment management	To manage all the paired equipments.

### Phone keyboard

Tap “Photo keypad” for the interface









### Control button:

	Close	Close the current dialog box
	Back	Click to delete the last character
	Dial up	To make a call
	Phonebook	Call history

## Call History



Tap “call record” for call history information.

### Control button:

	Close	Close the current interface ;
	Outgoing	Display all the outgoing calls lately
	Incoming calls	Display all the incoming calls lately
	Missed calls	Display all the missed calls lately
	Last	Display the last content
	Next	Display the next content
	Delete one	Delete the selected
	Delete all	Delete all the phone information
	Calling	Dial-up the selected phone

### Pairing interface





#### Control button:

	Close	Close the current dialog box ;
	Count down	Automatic count down from the beginning of pairing





### Bluetooth setting





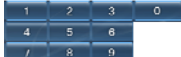

Tap “Bluetooth setting” for the menu.

#### Control button:

	Close	Close the current dialog box
	Reset pin code	Resetting pin code
	Ring-Tone	You can select one ring tone
	Turning On/Off Bluetooth function	Turning On/Off Bluetooth function

### Pin code setting interface:



	Close	Close the current dialog box
	Display zone	Display the inputted characters. <b>Pin code is “8888”</b>
	Number keyboard	Help you input the No.
	Back	Back space

	Confirm	Confirm your setting
<b>Pairing setting</b>		
<b>Control button:</b>		
	Close	Close the current dialog box
	Last	Display the last content
	Next	Display the next content
	Connect	Pairing
	Turn off	Turn off the current connection
	Delete	Delete all pairing history



## 2.5 Picture

### Support JPG, JPEG, BMP formats in SD card.

Tap [Picture] to browse picture folder.

Tap  to search for file. Tap  to exit. Tap  to open the selected file.

### Soft keys information:

 or  browse up and down.

 or  zoom in/out

 full screen on

 photo rotating.

 size

 exit.



## 3. Tools

### 3.1 Calculator

Tap [Calculator] in the system main menu to use calculator.

Tap  to exit.

### 3.2 Windows

Tap [Win Desk] in the system main menu to enter into Windows platform.



In Windows platform CE6.0, you can view your Microsoft Words, Excel, Power Point, PDF etc...

Windows Media Player is also available for multimedia files.

To exit from Windows CE 6.0, press on the [GPS\_MAIN] to exit to the system main menu.

### 3.3 FM

With this function, IDP4301 can connect with auto video/audio system.

1. Tap [FM] for FM transmission menu.
2. Tap  or  to adjust the FM frequency according to the FM radio frequency in your car.

## 4. System Settings

Tap [ System Set ] icon to customize the system settings such as backlight brightness, volume, and language... to your own preferred settings

Language setting:

Tap the corresponding national flag to select the language you need and save automatically.

### 4.1 Backlight Setting

Setting up of the duration of backlight and screen saver.

### 4.2 Power setting

To indicate battery current level and to set up Auto Sleep mode.

### 4.3 Sound

Tap “Sound” to set volume.

### 4.4 System info

To check on the information of the device.

### 4.5 Calibrate touch screen

You can calibrate the touch screen if it is not responding accurately to your stylus taps.

Tap on the calibration as indicated on the screen. Tap and hold at the center of the target. When the target moves to another position, tap and hold at the center of the new target. Repeat each time to complete the calibration process.

When the process is completed, tap screen to return to the Settings screen.

### 4.6 Update Logo

This function serves as the upgrading program for the device.

### 4.7 File management

This function is used for managing the files in SD card

### 4.8 AV IN Set

To toggle to reverse camera view if the system is fitted with reverse camera.

### 4.9 GPS Path

Use for configuration of GPS path for the device to detect the link to GPS map folder.

## 5. Quick Troubleshooting

Power	Cannot startup	Insufficient battery. Please connect the adapter and restart the system.
Screen	No screen displayed	If the system does not respond after powering up, try the following: 1. Connect an adapter, restart system. 2. Reset the system.
	Display speed is too slow	1. Check if the battery is low on power. 2. Reset the system.
	Screen has no response	Reset the system.
Navigation	GPS cannot display current location	Make sure your current location is not obstructed by buildings or other interferences.

## 6. Disclaimer

Smart-i Incorporation takes no responsibility for any use of this product that may result in law violation and/or accidents leading to personal injuries and/or property damage. It is the user's own responsibility to operate the product in a prudent manner that will comply with the law. Smart-i will take no responsibility for the consequences caused by inaccurate satellite transmissions.

## 7. Important Messages

- **Warning:** Do not operate Smart-i Navigator and a vehicle simultaneously as this is very dangerous. The vehicle must be parked prior to operating Smart-i. It is your sole responsibility to operate Smart-i and the vehicle in a prudent manner. Misusing Smart-i may result in accidents and may lead to injuries and/or property damage. Only a passenger, not the driver should operate Smart-i while the vehicle is in motion.
- **Caution:** Do not use Smart-i as a medium to generate precise readings of altitude, direction, distance, location or topography. Smart-i must only be used as a navigational aid. Any information generated from Smart-i must only be used as reference.
- **Caution:** Although every attempt has been made to ensure the accuracy of the maps and the data used by Smart-i, the location of points of interest, transportation networks, etc may change over time without notice therefore rendering the data obsolete. Therefore it is essential that you check the actual surroundings with Smart-i's maps in order to confirm that you are at the exact destination.
- **Caution:** Smart-i cannot guarantee that any parts of the planned route will be safe, closed to traffic, or restricted to certain types of vehicles or if traffic is congested. Therefore it is your responsibility to determine the safety of the suggested route and to ignore any illegal or unsafe routes.

## 8. Technical Support

Kindly refer to product origin's websites for service and support details;

EMAIL : [enquiries@smart-i.us](mailto:enquiries@smart-i.us)

WEB : [www.smart-i.us](http://www.smart-i.us)

We thank you for purchasing SMART-i product and Services.