

# Samsung M8800

## Quick Start Guide



### Samsung M8800

- Bluetooth
- Voice recorder
- music player
- Calendar
- Web Browse
- Java



# Contents

---

<b>Features</b>	<b>02</b>
<b>Precautions</b>	<b>02</b>
<b>Phone Layout</b>	<b>03</b>
<b>Set &amp; Link</b>	<b>04</b>
<b>Basic Use</b>	<b>04</b>
<b>Unpack</b>	<b>05</b>
<b>Solving Problem</b>	<b>06</b>

# Features

## **BLUETOOTH**

- Transfer media files and personal data, and connect to other devices using wireless Bluetooth technology.

## **MUSIC PLAYER**

- Play music files on your phone. You can use other phone functions while listening to music.

## **FM RADIO**

- Listen to your favourite radio stations anytime, anywhere.

## **WEB BROWSER**

- Access the wireless web to get up-to-the-minute information and a wide variety of media content.

## **JAVA**

- Enjoy Java-based games and download new games.

## **VOICE RECORDER**

- Control the quality and memory location of voice clips.

## **CALENDAR**

- Keep track of your daily, weekly, and monthly schedule

# Precautions

**Failure to comply with the following precautions may be dangerous or illegal.**

## **DRIVE SAFELY AT ALL TIMES**

- Avoid using your phone while driving and obey all regulations that restrict the use of mobile phones while driving. Use hands-free accessories to increase your safety when possible.

## **FOLLOW ALL SAFETY WARNINGS AND REGULATIONS**

- Comply with any regulations that restrict the use of a mobile phone in a certain area.

## **USE ONLY SAMSUNG-APPROVED ACCESSORIES**

- Using incompatible accessories may damage your phone or cause injury.

## **TURN OFF THE PHONE NEAR MEDICAL EQUIPMENT**

- Your phone can interfere with medical equipment in hospitals or health care facilities. Follow all regulations, posted warnings, and directions from medical personnel.

## **TURN OFF THE PHONE OR DISABLE THE WIRELESS FUNCTIONS WHEN IN AN AIRCRAFT**

- Your phone can cause interference with aircraft equipment. Follow all airline regulations and turn off your phone or switch to a mode that disables the wireless functions when directed by airline personnel.

## **PROTECT BATTERIES AND CHARGERS FROM DAMAGE**

- Avoid exposing batteries to very cold or very hot temperatures (below 0° C/32° F or above 45° C/ 113° F).

# Precautions

Extreme temperatures can reduce the charging capacity and life of your batteries.

- Prevent batteries from contacting metal objects, as this can create a connection between the + and - terminals of your batteries and lead to temporary or permanent battery damage.
- Never use a damaged charger or battery.

## HANDLE YOUR PHONE CAREFULLY AND SENSIBLY

- Do not allow your phone to get wet—liquids can cause serious damage. Do not handle your phone with wet hands. Water damage to your phone can void your manufacturer's warranty.
- Avoid using or storing your phone in dusty, dirty areas to prevent damage to moving parts.
- Your phone is a complex electronic device—protect it from impacts and rough handling to avoid serious damage.
- Do not paint your phone, as paint can clog moving parts and prevent proper operation.
- Avoid using the phone's camera flash or light close to the eyes of children or animals.

## AVOID INTERFERENCE WITH OTHER ELECTRONIC DEVICES

- Your phone emits radio frequency (RF) signals that may interfere with unshielded or improperly shielded electronic equipment, such as pacemakers, hearing aids, medical devices, and other electronic devices in homes or vehicles. Consult the manufacturers of your electronic devices to solve any interference problems you experience.

# Phone Layout

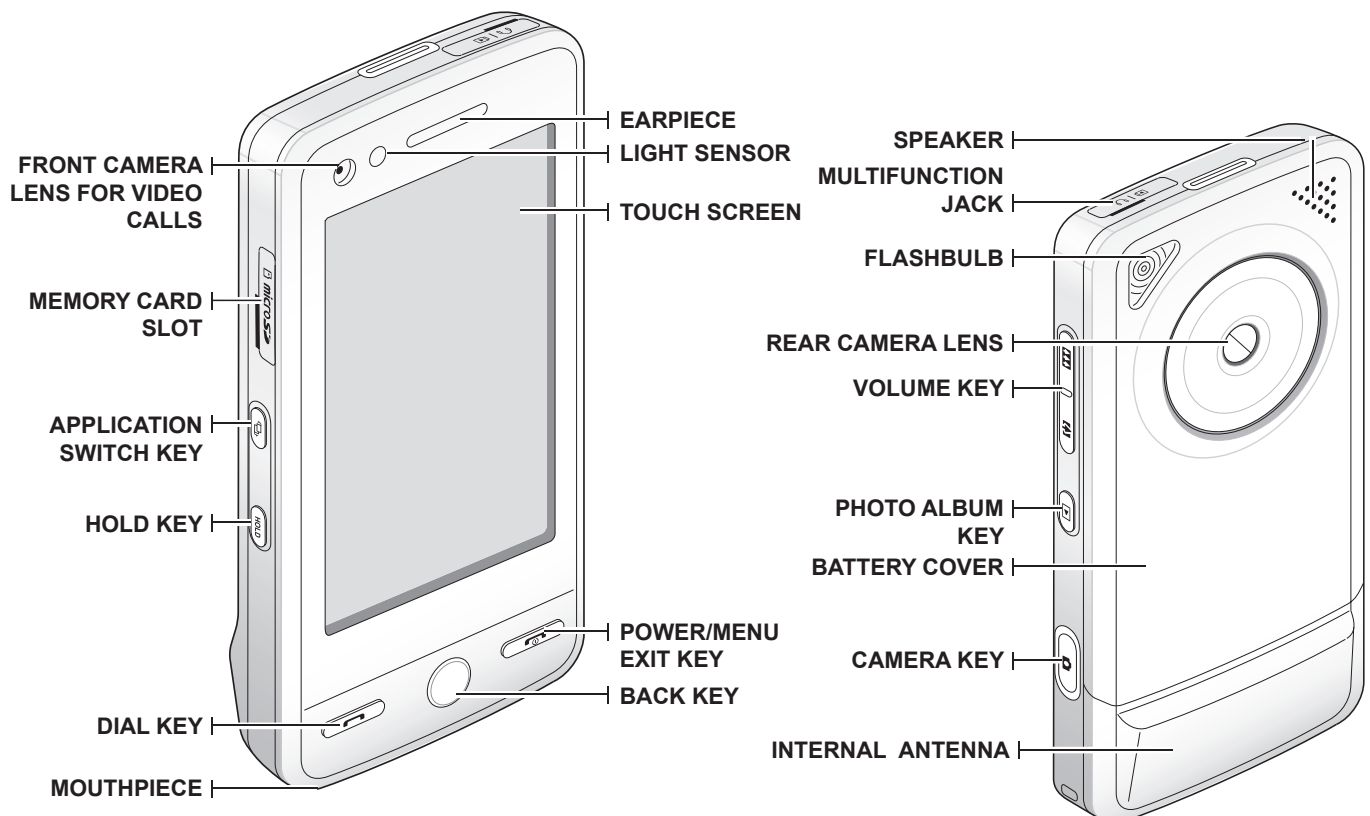

# Set & Link

First steps to operating your phone

## INSERT THE SIM CARD.

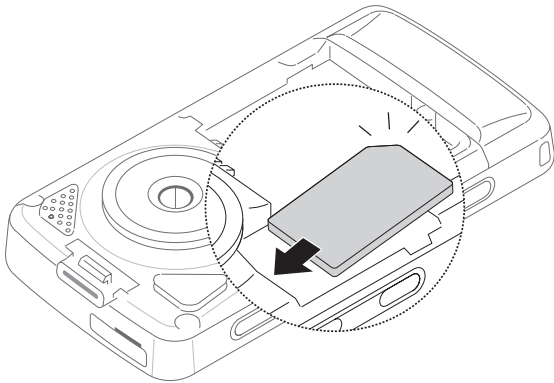

## INSERT THE BATTERY.

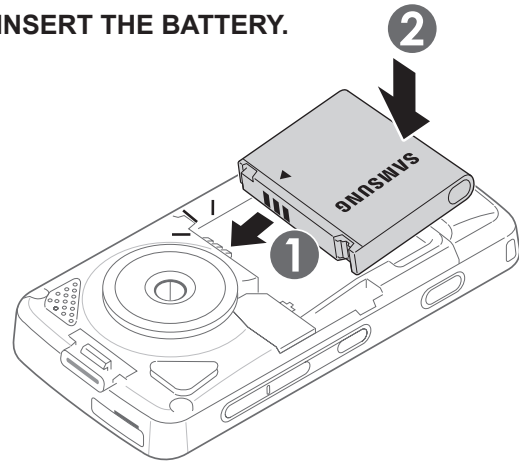

## REMOVE THE BATTERY COVER.

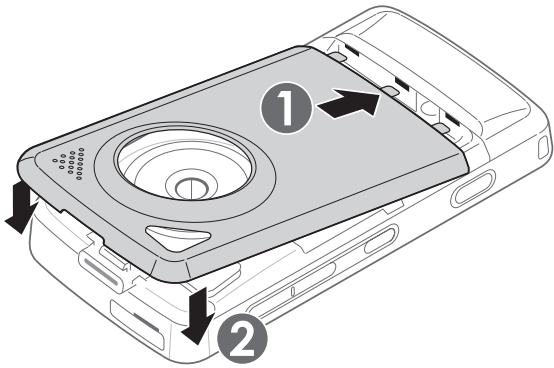

## PLUG THE TRAVEL ADAPTER INTO THE PHONE.

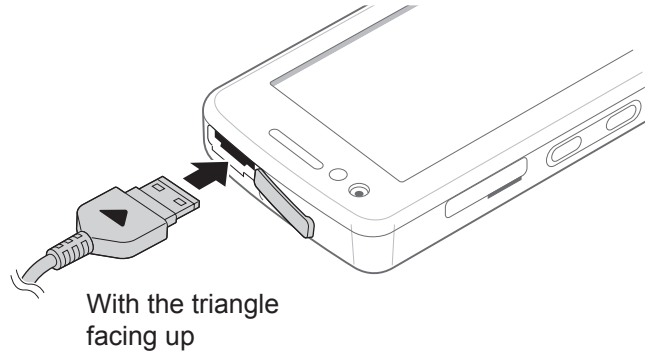

# Basic Use

Learn to make or answer calls and use basic call functions.

## CALLS

### Make a call

1. In Idle mode, tap Keypad and enter an area code and a phone number.
2. Press [ ] or tap Voice call to dial the number.  
For a video call, tap More → Video call or press and hold the Camera key.
3. To end the call, press [ ].

### Answer a call

1. When a call comes in, press [ ].  
For a video call, press [ ] and tap <Show me>.
2. To end the call, press [ ].

### T9

1. Tap the appropriate virtual key to enter an entire word.
2. When the word displays correctly, tap [ ] to insert a space.  
If the correct word does not display, select an alternate word from the list that appears.

### ABC

Tap the appropriate virtual key until the character you want appears on the display.

Check your product box for the following items:

- Mobile phone
- Battery
- Travel adapter (charger)
- User manual

You can obtain various accessories from your local Samsung dealer.

**Note:** The items supplied with your phone and the accessories available at your Samsung dealer may vary, depending on your country or service provider.

## Solving Problem

When you switch your phone on, the following messages may appear

### “INSERT SIM”

- Make sure that the SIM card is correctly installed

### “PHONE LOCK”

- The automatic locking function has been enabled.  
You must enter the phone’s password before you can use the phone.

### ENTER PUK

- The PIN code was entered incorrectly three times in succession and the phone is now blocked.  
Enter the PUK supplied by your service provider.

### ENTER PIN

- You are using your phone for the first time.  
You must enter the Personal Identification Number (PIN) supplied with the SIM card.
- The PIN Check feature is enabled. Every time the phone is switched on, the PIN has to be entered. To disable this feature, use the PIN check menu.

### “NO SERVICE,” “NETWORK FAILURE,” OR “NOT DONE” DISPLAYS

- The network connection has been lost. You may be in a weak signal area. Move and try again.
- You are trying to access an option for which you have not taken out a subscription with your service provider. Contact the service provider for further details.

### YOU HAVE ENTERED A NUMBER BUT IT WAS NOT DIALLED

- Make sure that you have pressed SEND
- Make sure that you have accessed the right cellular network.
- Make sure that you have not set an outgoing call barring option.

### A CALLER CANNOT REACH YOU

- Make sure that your phone is switched on. (Press END for more than one second.)
- Make sure that you are accessing the correct cellular network.
- Make sure that you have not set an incoming call barring option.

# Solving Problem



## **YOUR VOICE IS NOT HEARD AT THE OTHER END**

- Make sure that you have switched on the microphone.
- Make sure that you are holding the phone close enough to your mouth.  
The microphone is located at the bottom of the phone.

## **THE PHONE STARTS BEEPING AND “BATTERY LOW” FLASHES ON THE DISPLAY**

- Your battery is insufficiently charged. Recharge the battery.

## **THE AUDIO QUALITY OF THE CALL IS POOR”**

- Check the signal strength indicator on the display (  ).  
The number of bars indicates the signal strength from strong (  ) to weak (  ).
- Try moving the phone slightly or moving closer to a window if you are in a building.

## **NO NUMBER IS DIALLED WHEN YOU RE-CALL A ADDRESS ENTRY**

- Use the Phonebook feature to ensure the number has been stored correctly.
- Store the number again, if necessary.

## **THE BATTERY DOESN'T CHARGE PROPERLY OR THE PHONE SOMETIMES TURNS ITSELF OFF**

- Wipe the charging contacts both on the phone and on the battery with a clean soft cloth.

## **IF THE ABOVE GUIDELINES DO NOT HELP YOU TO SOLVE THE PROBLEM, TAKE NOTE OF**

- The model and serial numbers of your phone
- Your warranty details
- A clear description of the problem